

# Sioux Chief

MANUFACTURING SINCE 1957



**Product Catalog**  
**Edition 32.3**

Effective: Apr 1, 2023  
Prices Supersede All Previous Editions



## **Sioux Chief is an American Manufacturer**

Sioux Chief is a leading American manufacturer of rough plumbing products located in Kansas City, Missouri. We develop and manufacture some of the most diverse and innovative plumbing products in the country.

We focus on product innovation initiated by field research and interviews with plumbers, engineers, code officials and distributors. We're able to turn ideas into products quickly because we design and build our own machines. This also allows us to control manufacturing costs and minimize down-time, providing consistent, reliable value to our customers.

Our primary purpose as an American manufacturer is to provide better value to the professional plumbing and mechanical contractor by offering top-quality, innovative products with superior customer service. Our goal as an American innovator, is to make plumbing installation easier, more effective, and more efficient.

We strive every day to meet the demands of the rough plumbing industry with innovation, quality, and the American spirit.

# Catalog Edition 32.3

## Supply

### PowerPex® Systems

PowerPex® Tube	11
F1807 Systems	17
F2159 Systems	51
F1960 Systems	57
F3347 Systems	81

### Specialized Supply

CPVC Systems	89
Sch 40 CPVC	101
PVC Systems	105
Sweat/Copper	111
PDQ™ Push Fittings	133
Pipe Insulation	145

### Arresters & Trap Primers

Arresters	153
Trap Primers	161

### Access

Laundry Boxes	169
Appliance Boxes	177
Ice Maker Boxes	181
Toilet/Dishwasher Boxes	185
Lav Boxes	189
Kitchen Supply Boxes	195
Gas Service	199
Air-Admittance Boxes	203
Outlet Box Accessories	207
Panels	213

## Drainage

### Specification Drainage

Floor Drains	237
Floor Sinks	265
Roof Drains	275
Cleanouts	287
Fixture Carriers	305

### Commercial Drainage

Floor Drains	318
Floor Sinks	345
Roof Drains	353
Cleanouts	359

### Trench Drains

FastTrack™ System	379
HydroTec™ System	384
HydroBlock™ System	397
HydroLine™ System	401

### Residential Drainage

Shower Drains	407
Residential Floor Drains	427
Closet Flanges	437
Backwater Valves	447
Air Admittance Valves	451
Residential Accessories	457

### Testing

Test Devices	463
Gauges & Accessories	471

## Support

### Supply Hangers

Plastic CTS	479
Metal CTS/IPS	489
Anchors & Fasteners	495
<b>DWV Hangers</b>	
Extension Hangers	501
Hanger Straps	505
Ground Stakes	509

### Brackets

Stub Out Brackets	516
Commercial Brackets	533
Stud Guards & Safety Plates	549
Water Heater Accessories	553

## Specialties

### Tubular

Plastic Tubular	561
Metal Tubular	573
Basket Strainers & Sink Drains	591
Bath Waste Drains	599

### Plumbing Specialties

Supply Stops & Kits	609
Supply Tubes	617
Lav/Sink Specialties	621
Closet Specialties	631
Tub/Shower Specialties	639

### Tubing & Hose

Vinyl Tubing	648
Polyethylene Tubing	653
Hose	657
Fuel Line	661
Gasket Material	665

### Tubing/Hose Fittings

Fittings	671
----------	-----

### Tools & Chemicals

PowerPex® Tools	763
Tools & Accessories	767
Brushes & Abrasives	779
Sealants, Lubricants, & Tapes	783
Chemicals	787

Items in buying tables with BOLD type are non-stock items.  
Extended lead times may apply to non-stock items.

For Drainage items having one or more listed option, Buyer will be charged 33% of the applicable return price for product restocking; and will apply to canceled orders that have been entered but not shipped.



### **Making it in America – Since 1957**

American manufacturing generates almost 11% of the U.S. gross domestic product. It accounts for 60% of our exports and employs nearly 12 million people. 70% of U.S. dollars spent on research and development come from the manufacturing sector.

Sioux Chief manufactures more than 90% of the products we sell, employing more than 500 American workers in the process. We design, build and maintain all of our own copper tube forming tools, machines, plastic injection molds, packaging, cleaning and testing equipment as we produce the highest quality American-made plumbing parts.

Buy American when you can. We all succeed when you do!

# Supply

**PowerPEX<sup>®</sup> Systems**

**Specialized Supply**

**Supply Accessories**

**Arresters &  
Trap Primers**

**Access**

**»» Making it in America**

## A Brief Explanation of Terms Used in the Supply Section:

**CTS:** All Copper, CPVC, and PEX fitting sizes in this section refer to CTS (Copper Tube Size) unless otherwise specified. The CTS size (or "Nominal" size) is the common size reference. However, compression connections are commonly referred to by the "OD" of the tube that they fit (e.g., 1/2" CTS copper tube fits in a 5/8" OD Compression fitting). In these cases, the term "OD" will always be shown with the size.

**F1807:** We use this designation to indicate a PEX connection that conforms to the ASTM F1807 standard. Typically, F1807 fitting ends are made from copper or brass, and joints can be made with copper crimp rings, the V-Sleeve compression sleeve, or stainless steel cinch clamps.

**F2159:** We use this designation to indicate a PEX connection that conforms to the ASTM F2159 standard. F2159 fittings are made from an engineered polymer (such as PPSU), and joints can be made with copper crimp rings, the V-Sleeve compression sleeve, or stainless steel cinch clamps.

**F1960:** Sometimes referred to as "Wirsbo<sup>®</sup>," we use this designation to indicate a PEX connection that conforms to the ASTM F1960 standard. F1960 fitting ends can be made from brass or an engineered polymer. Joints are made with PEX expansion rings.

*Wirsbo<sup>®</sup> is a registered trademark of Uponor Corporation*

**F3347:** Sometimes referred to as "Viega<sup>®</sup>," we use this designation to indicate a PEX connection that conforms to the ASTM F3347 standard. F3347 fitting ends are typically made from brass, and joints are made with a stainless steel compression sleeve.

*Viega<sup>®</sup> is a registered trademark of Viega LLC.*

**FIP Swivel:** Female Iron Pipe - Unlike the MIP Swivel, the FIP Swivel has straight (NPS) threads, and utilizes a gasket seal. Pipe dope/sealants should not be used for these connections.

**Full-Port:** Ball valves that are designated as Full-Port have an opening through the ball that is as large or larger than the ID of the connecting tube.

**MIP Swivel:** Male Iron Pipe - Like standard MIP adapters, MIP swivel threads are tapered (NPT), but the adapter swivels, making it easier for installation and alignment of the fitting. Thread sealants are used on these connections.

**MSWT / FSWT:** We use these designations to indicate Male Sweat and Female Sweat copper fittings. A MSWT fitting end is the same as plain copper tube of the same size.

**NL/DZR:** This is used to designate fittings as being made from brass material that is No-Lead compliant\* (NL) and dezincification resistant (DZR).

*\* Complies with NSF-61 & 372 and California No Lead Plumbing Law*

**PPSU / PSU:** An engineered polymer that was developed for use in potable water systems and has been used for more than 20 years.

**SCC:** Stress-corrosion cracking - a type of cracking that can occur in some metals, caused by the combination of tensile stress and a corrosive environment.

**Spun Closed:** A process used extensively by Sioux Chief for mechanically sealing the end of copper tube, resulting in a signature 'bullet' shape.

# **PowerPEX<sup>®</sup> Systems**

**PowerPEX<sup>®</sup> Tube**

**for ASTM F1807**

**for ASTM F2159**

**for ASTM F1960**

**for ASTM F3347**

# PowerPEX<sup>®</sup> Systems

## PowerPEX<sup>®</sup> Tube

**ASTM F876:** Standard Specification for Cross-linked Polyethylene (PEX) Tubing

**ASTM F877:** Standard Specification for Cross-linked Polyethylene (PEX) Hot and Cold-Water Distribution Systems

**CSA B137.5:** Cross-linked Polyethylene (PEX) Tubing Systems for Pressure Applications

## ASTM F1807 | F2159 Crimp<sup>™</sup>



*Standard Specification for Metal<sup>1</sup> or Plastic<sup>2</sup> Insert Fittings Utilizing a Copper Crimp Ring, or Alternate Stainless Steel Clamps, for SDR9 Cross-linked Polyethylene (PEX) Tubing and SDR9 Polyethylene of Raised Temperature (PE-RT) Tubing*

1 = ASTM F1807 2 = ASTM F2159

## ASTM F1960 Grip<sup>™</sup>



*Standard Specification for Cold Expansion Fittings with PEX Reinforcing Rings for Use with Cross-linked Polyethylene (PEX) and Polyethylene of Raised Temperature (PE-RT) Tubing*

## ASTM F3347



*Standard Specification for Metal Press Insert Fittings with Factory Assembled Stainless Steel Press Sleeve for SDR9 Cross-linked Polyethylene (PEX) Tubing and SDR9 Polyethylene of Raised Temperature (PE-RT) Tubing*

### PowerPEX = The Power to Choose

The ability to choose the right tube or fitting connection for each application, layout or contractor comfort level. We call this Fitting Freedom<sup>™</sup>. Sioux Chief understands smart plumbing systems may incorporate “hybrid” PEX offerings to maximize each connection system's benefit. The Power to Choose puts the plumber back at the heart of smart plumbing.





# PowerPEX<sup>®</sup> Tube

**Type-B PEX Tube - Sticks & Coils**

**Type-A PEX Tube - Sticks & Coils**

Sioux Chief PowerPEX<sup>®</sup> tube is ideally suited for water distribution. Common applications include: water service/distribution, radiant heating/cooling, snow-melt systems, fire suppression, geothermal, etc.

**Note:** Special system component considerations must be made for radiant or snow melt systems when using non-barrier tubing.

All expansion joints made using PowerPEX Type-B tubing **MUST** be made with a self-rotating, power expansion tool to eliminate weak spots and avoid improper expansion rates.

Refer to Sioux Chief's PowerPEX Installation Manual for full restrictions and details.

Always check with local codes and applicable requirements.





**664X2W10**  
Page 11



**665X3R100**  
Page 11



**665X2W500**  
Page 12



**665X2R1000**  
Page 12



**665X2H500**  
Page 13



**664XA5W20**  
Page 13



**665XA2N500**  
Page 13



**665XA3N100H**  
Page 14



**305-X665**  
Page 14

## Type B PEX Tube

### Sticks

Item Number	Item Description	Pkg Type	Min Qty	Case Qty	Price
<b>10' STICKS</b>					
664X2B10	1/2" Blue, 50/Bag	B	1	1	\$265.00
664X2R10	1/2" Red, 50/Bag	B	1	1	\$265.00
664X2W10	1/2" White, 50/Bag	B	1	1	\$265.00
664X3B10	3/4" Blue, 25/Bag	B	1	1	\$242.50
664X3R10	3/4" Red, 25/Bag	B	1	1	\$242.50
664X3W10	3/4" White, 25/Bag	B	1	1	\$242.50
664X4B10	1" Blue, 15/Bag	B	1	1	\$265.50
664X4R10	1" Red, 15/Bag	B	1	1	\$265.50
664X4W10	1" White, 15/Bag	B	1	1	\$265.50
<b>20' STICKS</b>					
664X2B20	1/2" Blue, 50/Bag	B	1	1	\$530.00
664X2R20	1/2" Red, 50/Bag	B	1	1	\$530.00
664X2W20	1/2" White, 50/Bag	B	1	1	\$530.00
664X3B20	3/4" Blue, 25/Bag	B	1	1	\$485.00
664X3R20	3/4" Red, 25/Bag	B	1	1	\$485.00
664X3W20	3/4" White, 25/Bag	B	1	1	\$485.00
664X4B20	1" Blue, 15/Bag	B	1	1	\$531.00
664X4R20	1" Red, 15/Bag	B	1	1	\$531.00
664X4W20	1" White, 15/Bag	B	1	1	\$531.00
664X5W20	1-1/4" White, 10/Bag	B	1	1	\$840.00
664X6W20	1-1/2" White, 8/Bag	B	1	1	\$712.00
664X7W20	2" White, 5/Bag	B	1	1	\$1,035.00



664X3R10



664X2W20

## Type B PEX Tube

### Coils

Item Number	Item Description	Pkg Type	Min Qty	Case Qty	Price
<b>100' COILS</b>					
665X8W100	1/8" White	Bl	1	1	\$30.00
665X0W100	1/4" White	Bl	1	1	\$50.00
665X1W100	3/8" White	Bl	1	1	\$51.00
665X2B100	1/2" Blue	Bl	1	1	\$53.00
665X2R100	1/2" Red	Bl	1	1	\$53.00
665X2W100	1/2" White	Bl	1	1	\$53.00
665X3B100	3/4" Blue	Bl	1	1	\$97.00
665X3R100	3/4" Red	Bl	1	1	\$97.00
665X3W100	3/4" White	Bl	1	1	\$97.00
665X4B100	1" Blue	Bl	1	1	\$177.00
665X4R100	1" Red	Bl	1	1	\$177.00
665X4W100	1" White	Bl	1	1	\$177.00
665X5W100	1-1/4" White	Bl	1	1	\$420.00
665X6W100	1-1/2" White	Bl	1	1	\$445.00
665X7W100	2" White	Bl	1	1	\$1,035.00



665X2R100

Supply

Drainage

Support

Specialties

Appendix



665X2W300



665X2B500



665X2R1000



664X4H20

## Type B PEX Tube (Cont)

### Coils

Item Number	Item Description	Pkg Type	Min Qty	Case Qty	Price
<b>300' COILS</b>					
665X2B300	1/2" Blue	BI	1	1	\$159.00
665X2R300	1/2" Red	BI	1	1	\$159.00
665X2W300	1/2" White	BI	1	1	\$159.00
665X3B300	3/4" Blue	BI	1	1	\$291.00
665X3R300	3/4" Red	BI	1	1	\$291.00
665X3W300	3/4" White	BI	1	1	\$291.00
665X4B300	1" Blue	BI	1	1	\$531.00
665X4R300	1" Red	BI	1	1	\$531.00
665X4W300	1" White	BI	1	1	\$531.00
665X5W300	1-1/4" White	BI	1	1	\$1,260.00
665X6W300	1-1/2" White	BI	1	1	\$1,335.00
<b>500' COILS</b>					
665X2B500	1/2" Blue	BI	1	1	\$265.00
665X2R500	1/2" Red	BI	1	1	\$265.00
665X2W500	1/2" White	BI	1	1	\$265.00
665X3B500	3/4" Blue	BI	1	1	\$485.00
665X3R500	3/4" Red	BI	1	1	\$485.00
665X3W500	3/4" White	BI	1	1	\$485.00
665X4B500	1" Blue	BI	1	1	\$885.00
665X4R500	1" Red	BI	1	1	\$885.00
665X4W500	1" White	BI	1	1	\$885.00
<b>1000' COILS</b>					
665X2B1000	1/2" Blue	BI	1	1	\$530.00
665X2R1000	1/2" Red	BI	1	1	\$530.00
665X2W1000	1/2" White	BI	1	1	\$530.00

## Type B Oxygen Barrier PEX Tube

### Sticks

Item Number	Item Description	Pkg Type	Min Qty	Case Qty	Price
<b>20' STICKS</b>					
664X3H20	3/4" Orange, 25/Bag	B	1	1	\$710.00
664X4H20	1" Orange, 5/Bag	B	1	1	\$222.00

## Type B Oxygen Barrier PEX Tube

### Coils

Item Number	Item Description	Pkg Type	Min Qty	Case Qty	Price
<b>100' COILS</b>					
665X2H100	1/2" Orange	BI	1	1	\$83.00
665X3H100	3/4" Orange	BI	1	1	\$142.00
665X4H100	1" Orange	BI	1	1	\$222.00
665X9H100	5/8" Orange	BI	1	1	\$115.00

## Type B Oxygen Barrier PEX Tube (Cont)

### Coils

Item Number	Item Description	Pkg Type	Min Qty	Case Qty	Price
<b>300' COILS</b>					
665X2H300	1/2" Orange	BI	1	1	\$249.00
665X3H300	3/4" Orange	BI	1	1	\$426.00
665X4H300	1" Orange	BI	1	1	\$666.00
665X9H300	5/8" Orange	BI	1	1	\$345.00
<b>500' COILS</b>					
665X2H500	1/2" Orange	BI	1	1	\$415.00
665X3H500	3/4" Orange	BI	1	1	\$710.00
665X4H500	1" Orange	BI	1	1	\$1,110.00
665X9H500	5/8" Orange	BI	1	1	\$575.00
<b>1000' COILS</b>					
665X2H1000	1/2" Orange	BI	1	1	\$830.00
665X9H1000	5/8" Orange	BI	1	1	\$1,150.00
<b>1200' COILS</b>					
665X2H1200	1/2" Orange	BI	1	1	\$996.00



665X2H300



665X2H500

## Type A PEX Tube

### Sticks

Item Number	Item Description	Pkg Type	Min Qty	Case Qty	Price
<b>20' STICKS</b>					
664XA5W20	1-1/4" White, 5/Bag	B	1	1	\$495.00
664XA6W20	1-1/2" White, 5/Bag	B	1	1	\$468.00
664XA7W20	2" White, 5/Bag	B	1	1	\$1,197.00



664XA5W20

## Type A PEX Tube

### Coils

Item Number	Item Description	Pkg Type	Min Qty	Case Qty	Price
<b>100' COILS</b>					
665XA2N100	1/2" Natural	BI	1	1	\$87.00
665XA3N100	3/4" Natural	BI	1	1	\$155.00
665XA4N100	1" Natural	BI	1	1	\$222.00
<b>250' COILS</b>					
665XA2N250	1/2" Natural	BI	1	1	\$217.50
665XA3N250	3/4" Natural	BI	1	1	\$387.50
<b>500' COILS</b>					
665XA2N500	1/2" Natural	BI	1	1	\$435.00



665XA2N100



665XA2N250

Supply

Drainage

Support

Specialties

Appendix



665XA3N100H



665XA2N300H



305-X665

## Type A Oxygen Barrier PEX Tube

### Coils

Item Number	Item Description	Pkg Type	Min Qty	Case Qty	Price
<b>100' COILS</b>					
665XA3N100H	3/4" Natural	BI	1	1	\$202.00
<b>300' COILS</b>					
665XA2N300H	1/2" Natural	BI	1	1	\$353.10
<b>1000' COILS</b>					
665XA2N1000H	1/2" Natural	BI	1	1	\$1,180.00

## PowerPEX® Tools

### Coil Unwinder

Item Number	Item Description	Pkg Type	Min Qty	Case Qty	Price
305-X665	PEX Tube Coil Unwinder	BI	1	1	\$467.53

# **PowerPEX<sup>®</sup>** **Systems** **for ASTM F1807**

**ASTM F1807 - Fittings, Adapters & Connectors**

**ASTM F1807 - Preformed Copper & Valves**

**ASTM F1807 - PEX Kits**

**ASTM F1807 - Manifolds**

**ASTM F1807 - Tools**



Sioux Chief's PowerPEX<sup>®</sup> ASTM F1807 fitting system utilizes a copper crimp ring or the stainless steel V-Sleeve™, both of which provide 360° of compression around the sealing barbs. Stainless steel cinch clamps can also be used with PowerPex ASTM F1807 fitting system

This time-tested PEX system provides a secure, immediately testable and permanent connection.



**649X2**  
Page 17



**649TX2**  
Page 17



**649Y2**  
Page 18



**642X2**  
Page 18



**642XG4**  
Page 18



**641XG333**  
Page 18



**645XG3**  
Page 19



**645XC3**  
Page 20



**643X2**  
Page 21



**646XG3**  
Page 22



**647XG2E3**  
Page 23



**637X25**  
Page 25



**645X2G**  
Page 25



**630X248E**  
Page 26



**638X208**  
Page 27



**631XG02FP**  
Page 28



**633X18**  
Page 29



**634XG418FP**  
Page 29



**648XG3**  
Page 30



**119X208P**  
Page 31



**689X3202**  
Page 33



**672X0399**  
Page 36

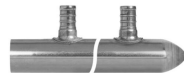

**672X0440**  
Page 40



**305-7120**  
Page 45



**304-11**  
Page 48



## Crimp Ring

- For use with PEX SDR9 tube only
- Do not use with PB tube
- Pure, annealed copper rings

### Related Products

Crimp Tool p 45

Item Number	Item Description	Pkg Type	Min Qty	Case Qty	Price
<b>COPPER</b>					
649X1	3/8" PEX	B	100	1000	\$0.34
649X2	1/2" PEX	B	100	1000	\$0.27
649X3	3/4" PEX	B	100	500	\$0.36
649X4	1" PEX	B	25	250	\$0.90
649X5	1-1/4" PEX	B	25	250	\$3.98
649X6	1-1/2" PEX	B	25	250	\$6.41
649X7	2" PEX	B	10	200	\$7.43



649X2

## V-Sleeve™

### PEX Compression Sleeve

- For use with PEX SDR9 tube only
- V-Sleeves™ are to be used with ASTM F1807 and F2159 PEX fittings in conjunction with any SDR9 PEX tubing manufactured to the ASTM F876 or ASTM F877
- Visibility of tube fully inserted in sleeve and to tube stop on fitting
- 360° compression on all sealing surface areas
- Sleeve can be pre-loaded onto fitting or tube
- Third-party tested to ASTM F877, UPC listed
- Patent# 8,123,257

### Related Products

V-Sleeve™ PEX crimp tools p 47

Item Number	Item Description	Pkg Type	Min Qty	Case Qty	Price
<b>STAINLESS STEEL</b>					
649TX2	1/2" PEX	B	100	1000	\$0.51
649TX3	3/4" PEX	B	100	500	\$0.67
649TX4	1" PEX	B	25	250	\$1.45



649TX2

Supply

Drainage

Support

Specialties

Appendix



649Y2

### Cinch Clamp

- For use with PEX SDR9 piping only
- Do not use with PB tube

Item Number	Item Description	Pkg Type	Min Qty	Case Qty	Price
<b>STAINLESS STEEL</b>					
649Y1PK1	3/8" PEX, 10/Bag	BI	1	200	\$5.37
649Y2	1/2" PEX, 100/Bag	BI	1	20	\$50.20
649Y3	3/4" PEX, 100/Bag	BI	1	10	\$58.94
649Y4PK1	1" PEX, 10/Bag	BI	1	10	\$9.47



642X2

### F1807 Elbow

- Tube stops formed into each fitting
- Copper - Longer radius bend for increased flow characteristics

Item Number	Item Description	Pkg Type	Min Qty	Case Qty	Price
<b>COPPER</b>					
642X2	1/2" × 1/2"	B	25	250	\$1.58
642X3	3/4" × 3/4"	B	25	250	\$2.58
642X4	1" × 1"	B	25	25	\$7.81
642X43	1" × 3/4"	B	25	25	\$9.36
<b>NL/DZR BRASS</b>					
642XG1	3/8" × 3/8"	B	25	250	\$1.90
642XG2	1/2" × 1/2"	B	25	250	\$1.87
642XG23	1/2" × 3/4"	B	25	250	\$2.26
642XG2PK1	1/2" × 1/2", 1/Bag	BI	10	10	\$2.12
642XG3	3/4" × 3/4"	B	25	250	\$2.85
642XG4	1" × 1"	B	25	25	\$5.35
642XG43	1" × 3/4"	B	25	25	\$16.62



642XG4

### F1807 Tee

- One-piece no lead brass

Item Number	Item Description	Pkg Type	Min Qty	Case Qty	Price
<b>STANDARD TEE - NL/DZR BRASS</b>					
641XG111	3/8" × 3/8" × 3/8"	B	50	500	\$2.34
641XG222	1/2" × 1/2" × 1/2"	B	50	50	\$2.38
641XG333	3/4" × 3/4" × 3/4"	B	20	200	\$3.94
641XG444	1" × 1" × 1"	B	20	200	\$7.93
<b>REDUCING TEE - NL/DZR BRASS</b>					
641XG322	3/4" × 1/2" × 1/2"	B	20	200	\$3.27
641XG323	3/4" × 1/2" × 3/4"	B	20	200	\$3.72
641XG332	3/4" × 3/4" × 1/2"	B	20	200	\$3.27
641XG442	1" × 1" × 1/2"	B	20	200	\$6.18
641XG443	1" × 1" × 3/4"	B	20	200	\$6.49



641XG333



641XG323

**F1807 Tee (Cont)**

Item Number	Item Description	Pkg Type	Min Qty	Case Qty	Price
<b>BULLHEAD TEE- NL/DZR BRASS</b>					
641XG223	1/2" × 1/2" × 3/4"	B	20	200	\$3.04



641XG223

**F1807 Coupling**

· Tube stops formed into each fitting

Item Number	Item Description	Pkg Type	Min Qty	Case Qty	Price
<b>COPPER</b>					
645X1	3/8" × 3/8"	B	100	1000	\$1.64
645X2	1/2" × 1/2"	B	100	1000	\$0.84
645X3	3/4" × 3/4"	B	50	500	\$1.14
645X32	3/4" × 1/2"	B	50	500	\$3.10
645X4	1" × 1"	B	25	250	\$2.89
645X43	1" × 3/4"	B	25	250	\$3.00
<b>NL/DZR BRASS</b>					
645XG1	3/8" × 3/8"	B	100	1000	\$1.04
645XG12	1/2" × 3/8"	B	50	500	\$2.83
645XG2	1/2" × 1/2"	B	100	1000	\$1.27
645XG3	3/4" × 3/4"	B	50	500	\$2.13
645XG32	3/4" × 1/2"	B	50	500	\$1.95
645XG4	1" × 1"	B	25	250	\$3.34
645XG43	1" × 3/4"	B	25	250	\$3.34



645X2



645XG2

**F1807 Plug**

· One-piece no lead brass

Item Number	Item Description	Pkg Type	Min Qty	Case Qty	Price
<b>NL/DZR BRASS</b>					
640XG01	3/8" F1807	B	100	1000	\$0.91
640XG02	1/2" F1807	B	100	1000	\$0.91
640XG03	3/4" F1807	B	100	1000	\$1.77
640XG04	1" F1807	B	25	250	\$2.70



640XG02

Supply

Drainage

Support

Specialties

Appendix

Supply

Drainage

Support

Specialties

Appendix



645XC3



645XGC3



645XCM2



645XC93



645X3P

## F1807 Straight Adapter

### CPVC, CTS

- A quick and easy transition
- Perfect for hooking up PEX underground water service lines to CPVC in-house piping systems

Item Number	Item Description	Pkg Type	Min Qty	Case Qty	Price
<b>CPVC CUP - COPPER</b>					
645XC2	1/2" F1807 × 1/2" CPVC	B	50	50	\$5.84
645XC23	1/2" F1807 × 3/4" CPVC	B	50	50	\$10.06
645XC2PK2	1/2" F1807 × 1/2" CPVC, 1/Bag	CI	10	10	\$5.99
645XC3	3/4" F1807 × 3/4" CPVC	B	50	50	\$6.47
645XC34	3/4" F1807 × 1" CPVC	B	20	20	\$17.82
645XC3PK2	3/4" F1807 × 3/4" CPVC, 1/Bag	CI	10	10	\$6.62
645XC4	1" F1807 × 1" CPVC	B	20	20	\$17.52
645XC43	1" F1807 × 3/4" CPVC	B	20	20	\$17.82
<b>CPVC CUP - NL/DZR BRASS</b>					
645XGC2	1/2" F1807 × 1/2" CPVC	B	50	50	\$17.36
645XGC3	3/4" F1807 × 3/4" CPVC	B	50	50	\$13.74
645XGC4	1" F1807 × 1" CPVC	X	20	20	\$25.39
<b>CPVC MALE - COPPER</b>					
645XCM2	1/2" F1807 × 1/2" Male CPVC	B	50	50	\$8.62

## F1807 Straight Adapter

### CPVC - IPS Gray

Item Number	Item Description	Pkg Type	Min Qty	Case Qty	Price
<b>COPPER</b>					
645XC923	1/2" F1807 × 3/4" Sch 40 CPVC	B	25	25	\$12.47
645XC93	3/4" F1807 × 3/4" Sch 40 CPVC	B	50	50	\$12.15
645XC94	1" F1807 × 1" Sch 40 CPVC	B	20	20	\$24.41

## F1807 Straight Adapter

### PVC

- Perfect for water service transitions
- Made from Type L copper tube
- For cold water applications. Do not exceed 140° F.

Item Number	Item Description	Pkg Type	Min Qty	Case Qty	Price
<b>COPPER</b>					
645X23P	1/2" F1807 × 3/4" PVC	B	50	50	\$12.53
645X34P	3/4" F1807 × 1" PVC	B	20	20	\$18.73
645X3P	3/4" F1807 × 3/4" PVC	B	50	50	\$11.89
645X43P	1" F1807 × 3/4" PVC	B	20	20	\$18.86
645X4P	1" F1807 × 1" PVC	B	20	20	\$19.64

## F1807 Straight Adapter

### Male Sweat

Item Number	Item Description	Pkg Type	Min Qty	Case Qty	Price
<b>COPPER</b>					
643X11	3/8" F1807 × 3/8" MSWT	B	100	1000	\$2.00
643X2	1/2" F1807 × 1/2" MSWT	B	100	1000	\$0.97
643X202	1/2" F1807 × 1/2" MSWT, 2" Long	B	50	500	\$2.91
643X23	3/4" F1807 × 1/2" MSWT	B	50	100	\$1.81
643X3	3/4" F1807 × 3/4" MSWT	B	50	500	\$1.77
643X32	1/2" F1807 × 3/4" MSWT	B	50	500	\$3.96
643X34	1" F1807 × 3/4" MSWT	B	25	250	\$3.96
643X4	1" F1807 × 1" MSWT	B	25	250	\$4.01
643X43	3/4" F1807 × 1" MSWT	B	25	250	\$4.88
<b>NL/DZR BRASS</b>					
643XG1	3/8" F1807 × 1/2" MSWT	B	100	1000	\$7.37
643XG2	1/2" F1807 × 1/2" MSWT	B	100	1000	\$1.52
643XG23	3/4" F1807 × 1/2" MSWT	B	50	500	\$4.23
643XG3	3/4" F1807 × 3/4" MSWT	B	50	500	\$2.61
643XG32	1/2" F1807 × 3/4" MSWT	B	50	500	\$5.39
643XG34	1" F1807 × 3/4" MSWT	B	25	250	\$5.85
643XG4	1" F1807 × 1" MSWT	B	25	250	\$4.13
643XG43	3/4" F1807 × 1" MSWT	B	25	250	\$7.09



643X2



643XG2

## F1807 Straight Adapter

### Female Sweat

Item Number	Item Description	Pkg Type	Min Qty	Case Qty	Price
<b>COPPER</b>					
644X2	1/2" F1807 × 1/2" FSWT	B	100	1000	\$1.07
644X23	3/4" F1807 × 1/2" FSWT	B	25	100	\$2.24
644X3	3/4" F1807 × 3/4" FSWT	B	50	500	\$1.81
644X32	1/2" F1807 × 3/4" FSWT	B	50	500	\$4.02
644X34	1" F1807 × 3/4" FSWT	B	25	250	\$4.57
644X4	1" F1807 × 1" FSWT	B	25	250	\$4.58
644X43	3/4" F1807 × 1" FSWT	B	25	250	\$4.49
<b>NL/DZR BRASS</b>					
644XG1	3/8" F1807 × 1/2" FSWT	B	100	500	\$4.04
644XG2	1/2" F1807 × 1/2" FSWT	B	100	1000	\$1.56
644XG3	3/4" F1807 × 3/4" FSWT	B	50	500	\$2.69
644XG32	1/2" F1807 × 3/4" FSWT	B	50	500	\$7.10
644XG4	1" F1807 × 1" FSWT	B	25	250	\$4.55
644XG43	3/4" F1807 × 1" FSWT	B	25	250	\$9.48



644X2



644XG2



646XG2

### F1807 Straight Adapter

#### MIP

· One-piece no lead brass

Item Number	Item Description	Pkg Type	Min Qty	Case Qty	Price
<b>NL/DZR BRASS</b>					
646XG2	1/2" F1807 × 1/2" MIP	B	100	100	\$2.61
646XG23	3/4" F1807 × 1/2" MIP	B	50	50	\$2.78
646XG3	3/4" F1807 × 3/4" MIP	B	25	250	\$3.85
646XG32	1/2" F1807 × 3/4" MIP	B	50	50	\$3.72
646XG34	1" F1807 × 3/4" MIP	B	25	25	\$4.55
646XG4	1" F1807 × 1" MIP	B	50	50	\$6.56
646XG43	3/4" F1807 × 1" MIP	B	50	50	\$6.42



647XG2

### F1807 Straight Adapter

#### FIP

· One-piece no lead brass

Item Number	Item Description	Pkg Type	Min Qty	Case Qty	Price
<b>NL/DZR BRASS</b>					
647XG2	1/2" F1807 × 1/2" FIP	B	50	250	\$2.91
647XG23PK2	1/2" F1807 × 3/4" FIP, 1/Bag	CI	10	10	\$8.03
647XG3	3/4" F1807 × 3/4" FIP	B	50	50	\$4.35
647XG4	1" F1807 × 1" FIP	B	50	50	\$8.61



632XG332M

### F1807 Elbow Adapter

#### MIP

· One-piece no lead brass

Item Number	Item Description	Pkg Type	Min Qty	Case Qty	Price
<b>NL/DZR BRASS</b>					
632XG222M	1/2" F1807 × 1/2" MIP	B	50	50	\$7.77
632XG332M	3/4" F1807 × 3/4" MIP	B	50	50	\$18.32

## F1807 Elbow Adapter

### Tub/Shower Elbow

- Internal 1/2" FIP thread for shower arm or tub nipple
- For use on shower risers, tub spouts and non-pressure fitting applications

#### Related Products

Shower Arm Test Plug p 467

WiderSlider™ Adjustable Bracket p 529

Item Number	Item Description	Pkg Type	Min Qty	Case Qty	Price
<b>DROP-EAR - NL/DZR BRASS</b>					
647XG21E3	1/2" F1807 × 3/8" FIP	B	25	25	\$8.31
647XG2E3	1/2" F1807 × 1/2" FIP	B	50	50	\$10.38
647XG2EPK1	1/2" F1807 × 1/2" FIP, 1/Bag	B	20	20	\$10.19
<b>DROP-EAR - LEADED</b>					
647X23E	3/4" F1807 × 1/2" FIP	B	50	50	\$9.94
<b>SHOWER-LOCK - LEADED</b>					
616X2PX	1/2" F1807 × 1/2" FIP	B	50	50	\$17.15

## F1807 Elbow Adapter

### 3/4" FIP Swivel

- DO NOT use pipe dope on FIP swivel threads
- Full flow - no restriction
- Brass FIP swivel nut includes gasket

Item Number	Item Description	Pkg Type	Min Qty	Case Qty	Price
<b>NL/DZR</b>					
637X235	1/2" F1807	B	50	50	\$10.38
637X335	3/4" F1807	B	25	25	\$9.69



647XG2E3



616X2PX



637X235

Supply

Drainage

Support

Specialties

Appendix



632X222

### F1807 Elbow Adapter

#### Male Sweat

- Great multipurpose sweat × PEX elbow
- Perfect as tub/shower connector
- One-piece solid copper

#### Related Products

Tub/Shower Connector p 28

Item Number	Item Description	Pkg Type	Min Qty	Case Qty	Price
<b>COPPER</b>					
632X222	1/2" F1807 × 1/2" MSWT	B	100	1000	\$2.59
632X232	1/2" F1807 × 3/4" MSWT	B	50	250	\$5.23
632X332	3/4" F1807 × 3/4" MSWT	B	25	250	\$3.88



632X225

### F1807 Elbow Adapter

#### Female Sweat

- Great multipurpose sweat × PEX elbow
- One-piece solid copper

Item Number	Item Description	Pkg Type	Min Qty	Case Qty	Price
<b>COPPER</b>					
632X225	1/2" F1807 × 1/2" FSWT	B	100	1000	\$2.59
632X235	1/2" F1807 × 3/4" FSWT	B	25	250	\$5.47
632X335	3/4" F1807 × 3/4" FSWT	B	25	250	\$3.88

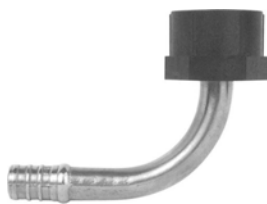

637X423PK

### F1807 Ballcock Adapter

#### Toilet Swivel

- Nose cone seal. Do not use thread sealant
- Easily connects PEX to ballcock thread
- Swivel ballcock nut includes nose cone washer

Item Number	Item Description	Pkg Type	Min Qty	Case Qty	Price
<b>STRAIGHT - COPPER</b>					
637X410	3/8" F1807 x Ballcock Swivel	B	50	500	\$3.20
637X420	1/2" F1807 x Ballcock Swivel	B	50	50	\$3.14
<b>ELBOW - COPPER</b>					
637X413	3/8" F1807 × Ballcock Swivel	B	50	50	\$5.89
637X423PK	1/2" F1807 × Ballcock Swivel	CI	10	10	\$7.96



## F1807 Faucet Adapter

### 1/2" FIP Swivel

- Nose cone seal. Do not use thread sealant
- Easily connects PEX to faucet thread
- High impact FIP swivel nut includes nose cone gasket

Item Number	Item Description	Pkg Type	Min Qty	Case Qty	Price
<b>STRAIGHT - COPPER</b>					
637X20	1/2" F1807	B	50	500	\$1.91
637X20PK2	1/2" F1807, 2/Bag	Cl	10	10	\$4.12
<b>ELBOW - COPPER</b>					
637X25	1/2" F1807	B	50	50	\$3.40



637X10



637X25

## Straight Adapter

### Compression

- DO NOT use pipe dope on comp. threads
- Connects PEX to 3/8" O.D. tube
- Perfect for lav/sink supply hookup
- Lead-free solder joint

Item Number	Item Description	Pkg Type	Min Qty	Case Qty	Price
<b>NL/DZR</b>					
637XG711	3/8" F1807 × 3/8" O.D. Comp.	B	20	20	\$11.30
637XG721	1/2" F1807 × 3/8" O.D. Comp.	B	20	20	\$9.99



637XG721

## Straight Adapter

### Polybutylene (PB) (ASTM F1380) × PEX

- Great for adapting PB lines to new PEX lines
- Each adapter is bagged with one natural copper PB crimp ring and one black copper PEX crimp ring
- For use with PEX SDR9 tube only

Item Number	Item Description	Pkg Type	Min Qty	Case Qty	Price
<b>COPPER</b>					
645X2G	1/2" F1807 × 1/2" PB w/Rings	B	50	50	\$2.71
645X2GPK2	1/2" F1807 × 1/2" PB w/Rings, 1/Bag	Cl	10	10	\$2.86
645X3G	3/4" F1807 × 3/4" PB w/Rings	B	50	50	\$3.22
645X3GPK2	3/4" F1807 × 3/4" PB w/Rings, 1/Bag	Cl	10	10	\$3.52



645X2GPK2

Supply

Drainage

Support

Specialties

Appendix



630X248

### F1807 Stub Out Elbow

- Accepts sweat, push-fitting and compression valves
- Combines easy adapting of copper stub outs with easy installation of PEX system
- Type L copper
- Tube stops formed into each fitting
- One-piece solid copper

#### Related Products

F1807 Stub Out Kit p 33

Item Number	Item Description	Pkg Type	Min Qty	Case Qty	Price
630X146	3/8" F1807, 3-1/2" x 6"	B	50	50	\$6.20
630X148	3/8" F1807, 3-1/2" x 8"	B	50	50	\$6.95
630X2138	1/2" F1807, 13" x 8"	B	50	50	\$15.12
630X2412	1/2" F1807, 3-1/2" x 12"	B	50	50	\$10.41
630X246	1/2" F1807, 3-1/2" x 6"	B	50	50	\$5.58
630X248	1/2" F1807, 3-1/2" x 8"	B	50	50	\$6.42
630X248PK	1/2" F1807, 3-1/2" x 8"	CI	6	6	\$6.92
630X3136	3/4" F1807, 13" x 6"	B	50	50	\$20.85
630X3412	3/4" F1807, 4-1/2" x 12"	B	50	50	\$20.84
630X348	3/4" F1807, 4-1/2" x 8"	B	50	50	\$19.15
630X4612	1" F1807, 6" x 12"	B	25	25	\$34.75
630X468	1" F1807, 6" x 8"	B	25	25	\$26.38

### F1807 Stub Out Elbow

#### Square O Strap



630X248E

- Accepts sweat, push-fitting and compression valves
- Combines easy adapting of copper stub outs with easy installation of PEX system
- Square O Straps affix easily to the Edge bracket or any backing board to provide solid installations
- Type L copper

Item Number	Item Description	Pkg Type	Min Qty	Case Qty	Price
630X148E	3/8" F1807, 3-1/2" x 8" w/Strap	B	25	25	\$7.93
630X2412E	1/2" F1807, 3-1/2" x 12" w/Strap	B	25	25	\$11.41
630X246E	1/2" F1807, 3-1/2" x 6" w/Strap	B	25	25	\$6.58
630X248E	1/2" F1807, 3-1/2" x 8" w/Strap	B	25	25	\$7.40
630X248EPK	1/2" F1807, 3-1/2" x 8" w/Strap	CI	20	20	\$7.90
630X348E	3/4" F1807, 4-1/2" x 8" w/Strap	B	25	25	\$14.86
630X468E	1" F1807, 6" x 8" w/Strap	B	10	10	\$27.38

## F1807 Stub Out Elbow

### Double Stub Out

- Brazed stub out joint will not fracture

#### Related Products

3-Valve Kitchen Supply Box p 195

Item Number	Item Description	Pkg Type	Min Qty	Case Qty	Price
630XD288	1/2" F1807, 7" x 8" x 8"	B	25	25	\$25.63



630XD288

## F1807 Bullet™

- Type L copper
- Strapped - Perfect for stubbing up through floor for closets or lavs
- Not to be used as permanent air chambers

Item Number	Item Description	Pkg Type	Min Qty	Case Qty	Price
<b>SPUN CLOSED</b>					
638X208	1/2" F1807, 8"	B	100	100	\$5.16
638X208PK	1/2" F1807, 8"	Cl	20	20	\$5.66
638X212	1/2" F1807, 12"	B	100	100	\$7.18
638X312	3/4" F1807, 12"	B	50	50	\$14.28
<b>SPUN CLOSED WITH STRAP</b>					
638X212E	1/2" F1807, 12" Long, 8" Stub Out	B	50	50	\$8.82
638X218E	1/2" F1807, 18" Long, 10" Stub Out	B	25	25	\$12.36
<b>OPEN ENDED STUB OUT</b>					
643X208	1/2" F1807, 8"	B	100	100	\$5.31
643X212	1/2" F1807, 12"	B	100	100	\$7.15



638X208



638X212E



643X208

Supply

Drainage

Support

Specialties

Appendix

Supply

Drainage

Support

Specialties

Appendix



632X283



632X263Y



631X02



631XG02FP

### F1807 Tub/Shower Pressure Connector

- DO NOT use pipe dope on FIP swivel threads
- Perfect for sweat connection to standard tub/shower valves
- MIP and FIP swivel connections mean no torch at the tub/shower valve
- Made from Type L copper tube
- Elongated tailpiece allows for rigid bracket attachment
- NL/DZR

Item Number	Item Description	Pkg Type	Min Qty	Case Qty	Price
632X243	1/2" F1807 × 1/2" MSWT, 4" × 2-1/4"	B	50	50	\$4.01
632X243PK	1/2" F1807 × 1/2" MSWT, 4" × 2-1/4"	CI	20	20	\$4.51
632X263	1/2" F1807 × 1/2" MSWT, 6" × 2-1/4"	B	50	50	\$4.82
632X263X	1/2" F1807 × 1/2" MIP Swivel, 6" × 3"	B	50	50	\$11.72
632X263Y	1/2" F1807 × 1/2" FIP Swivel, 6" × 3"	B	50	50	\$11.02
632X283	1/2" F1807 × 1/2" MSWT, 8" × 2-1/4"	B	50	50	\$6.17
632X458	1" F1807 × 1" MSWT, 5" × 8"	B	25	25	\$25.41

### F1807 Water Heater Connector

#### FIP Swivel Elbow

- DO NOT use pipe dope on FIP swivel threads
- Brass FIP swivel nut includes gasket
- Fitting with 600 WOG full port ball valve available
- Dielectric fitting
- Lead-free solder joint
- 3/4" type L copper
- NL/DZR

Item Number	Item Description	Pkg Type	Min Qty	Case Qty	Price
<b>STANDARD</b>					
631X02	3/4" F1807 × 3/4" FIP Swivel, 4-1/2" × 2"	B	25	25	\$16.72
631XG3TM9	3/4" F1807 × 3/4" FIP Swivel, w/ 3/4" MIP Branch, 6" × 9"	B	25	25	\$36.14
<b>VALVED, FULL PORT</b>					
631XG02FP	3/4" F1807 × 3/4" FIP Swivel, 6" × 3"	B	12	12	\$51.72

## F1807 Water Heater Connector

### FIP Swivel Straight

- DO NOT use pipe dope on FIP swivel threads
- Full flow, dielectric fitting - no restriction
- Brass FIP swivel nut includes gasket
- Fitting with 600 WOG full port ball valve available
- Made from Type L copper tube
- Lead-free solder joint
- NL/DZR

Item Number	Item Description	Pkg Type	Min Qty	Case Qty	Price
<b>STANDARD</b>					
633X02	3/4" F1807 × 3/4" FIP Swivel, 2"	B	25	25	\$8.94
633X18	3/4" F1807 × 3/4" FIP Swivel, 18"	B	25	25	\$24.50
633X18PK	3/4" F1807 × 3/4" FIP Swivel, 18", 1/Bag	Cl	25	25	\$25.00
<b>VALVED, FULL PORT</b>					
633XG18FP	3/4" F1807 × 3/4" FIP Swivel, 18"	Bl	10	10	\$59.50
633XG18FPT	3/4" F1807 × 3/4" FIP Swivel, w/ 3/4" FIP Branch, 18"	B	10	10	\$73.50
<b>THERMAL EXPANSION VALVE, FULL PORT</b>					
633XG18FRV	3/4" F1807 × 3/4" FIP Swivel, w/ Pressure Relief 3/8" Comp., 18"	B	10	10	\$69.50
633XG18HRV	3/4" F1807 × 3/4" FIP Swivel, w/ Pressure Relief 3/8" Hose Barb, 18"	B	10	10	\$69.50
633XG18XRV	3/4" F1807 × 3/4" FIP Swivel, w/ Pressure Relief 1/2" F1807, 18"	B	10	10	\$69.50
<b>ADJUSTABLE REPLACEMENT RELIEF PORT</b>					
648-ARX	1/8" MIP × 1/2" F1807 (80-125 PSI)	Bl	6	6	\$9.80



633XG18HRV

## F1807 Water Heater Connector

### Flexible Copper, FIP Swivel

- DO NOT use pipe dope on FIP swivel threads
- Do not twist or kink flexible connector
- Brass FIP swivel nut includes gasket
- Fitting with 600 WOG full port ball valve available
- Flexible dielectric fitting works well in tight spaces
- Lead-free solder joint
- NL/DZR

Item Number	Item Description	Pkg Type	Min Qty	Case Qty	Price
<b>STANDARD</b>					
634X418	3/4" F1807 × 3/4" FIP Swivel, 18"	Bl	10	10	\$20.69
<b>VALVED, FULL PORT</b>					
634XG418FP	3/4" F1807 × 3/4" FIP Swivel, 18"	Bl	25	25	\$54.39



634X418



634XG418FP

Supply

Drainage

Support

Specialties

Appendix

Supply

Drainage

Support

Specialties

Appendix



633XG3TM6

### F1807 Water Heater Connector

#### FIP Swivel With MIP Branch

- DO NOT use pipe dope on FIP swivel threads
- NL/DZR

Item Number	Item Description	Pkg Type	Min Qty	Case Qty	Price
633XG3TM6	3/4" F1807 × 3/4" FIP, w/ 3/4" MIP Branch	B	25	25	\$33.83



633XG3TF6

### F1807 Water Heater Connector

#### FIP Swivel With FIP Tee

- DO NOT use pipe dope on FIP swivel threads
- NL/DZR

Item Number	Item Description	Pkg Type	Min Qty	Case Qty	Price
633XG3TF6	3/4" F1807 × 3/4" FIP, w/ 3/4" FIP Tee	B	10	10	\$27.61



636X48884

### F1807 Water Loop

#### Water Heater Stub Out Loop

- Preformed copper loop bypasses water heater before test
- Made from Type L copper tube

Item Number	Item Description	Pkg Type	Min Qty	Case Qty	Price
636X38883	3/4" F1807	B	12	12	\$56.03
636X48884	1" F1807	B	12	12	\$76.35



648XG3

### F1807 Brass Ball Valve

- Chrome-plated ball, blowout-proof stem
- ANSI/NSF 61
- NL/DZR Brass

Item Number	Item Description	Pkg Type	Min Qty	Case Qty	Price
<b>FULL PORT</b>					
648XG2	1/2" F1807	B	10	120	\$12.93
648XG2PK	1/2" F1807	CI	10	10	\$13.43
648XG3	3/4" F1807	B	8	96	\$19.53
648XG3PK	3/4" F1807	CI	10	10	\$20.03
648XG4	1" F1807	B	4	40	\$34.48
648XG4PK	1" F1807	CI	6	6	\$34.98

**F1807 Brass Ball Valve (Cont)**

Item Number	Item Description	Pkg Type	Min Qty	Case Qty	Price
<b>FULL PORT WITH DRAIN</b>					
648XG2FPD	1/2" F1807	B	5	30	\$28.52
648XG3FPD	3/4" F1807	B	5	30	\$30.05
<b>FULL PORT FIPS X F1807</b>					
648-3SX	3/4" FIPS x 3/4" F1807	X	5	5	\$33.66
<b>THERMAL EXPANSION VALVE - 125 PSI</b>					
648XG3XRV	3/4" F1807 x 3/4" F1807, 1/2" F1807 Port	BI	6	6	\$45.00



648-3SX



648XG3XRV

**F1807 Sillcock**

Item Number	Item Description	Pkg Type	Min Qty	Case Qty	Price
<b>LEADED BRASS</b>					
117X2	1/2" F1807	BI	10	100	\$21.36



117X2

**F1807 Frost-Proof Anti-Siphon Sillcock**

**Related Products**

Frost-Proof Sillcock Replacement Parts p 124

Item Number	Item Description	Pkg Type	Min Qty	Case Qty	Price
<b>MULTI-TURN - LEADED</b>					
118X204	1/2" F1807 x 3/4" MHT, 4"	BI	1	40	\$32.18
118X204P	1/2" F1807 x 3/4" MHT, 4"	B	5	5	\$26.50
118X206	1/2" F1807 x 3/4" MHT, 6"	BI	1	40	\$33.44
118X208	1/2" F1807 x 3/4" MHT, 8"	BI	1	40	\$34.07
118X210	1/2" F1807 x 3/4" MHT, 10"	BI	1	40	\$36.14
118X212	1/2" F1807 x 3/4" MHT, 12"	BI	1	40	\$37.41
<b>1/4 TURN - LEADED</b>					
119X204P	1/2" F1807 x 3/4" MHT, 4"	B	2	2	\$59.19
119X206P	1/2" F1807 x 3/4" MHT, 6"	B	5	5	\$64.18
119X208P	1/2" F1807 x 3/4" MHT, 8"	B	5	5	\$66.09
119X210P	1/2" F1807 x 3/4" MHT, 10"	B	5	5	\$69.92
119X212P	1/2" F1807 x 3/4" MHT, 12"	B	5	5	\$77.58



118X208



119X208P

Supply

Drainage

Support

Specialties

Appendix



637XG920



637XG9220

## F1807 Ice Maker Valve

### Straight & Tee

- DO NOT use pipe dope on comp. threads
- Great for adding 1/4" O.D. supply lines for ice makers or humidifiers

#### Related Products

Add-A-Line™ Push Valve p 139

Item Number	Item Description	Pkg Type	Min Qty	Case Qty	Price
<b>STRAIGHT - NL/DZR BRASS</b>					
637XG920	1/2" F1807 × 1/4" O.D. Comp.	B	25	250	\$20.67
637XG920PK1	1/2" F1807 × 1/4" O.D. Comp., 1/Bag	BI	10	10	\$20.92
<b>TEE - NL/DZR BRASS</b>					
637XG9220	1/2" F1807 × 1/4" O.D. Comp.	B	25	250	\$28.91
637XG9220PK1	1/2" F1807 × 1/4" O.D. Comp., 1/Bag	BI	10	10	\$29.16



## F1807 Stub Out Kit

### 1/2" Water Closet Stub Out With Bracket

- Manage materials more easily
- Save labor costs
- Prevent leaks by using preformed copper
- All copper components are made from Type L copper tube
- For individual product details, see product pages



689X2101

Item Number	Item Description	Pkg Type	Min Qty	Case Qty	Price
<b>16" STUD BAY</b>					
689X2101	(1) 525-1612, (1) 630X246	BI	12	12	\$11.04
689X2201	(1) 525-1612, (1) 630X248	BI	12	12	\$11.88
<b>24" STUD BAY</b>					
689X2111	(1) 525-2412, (1) 630X246	BI	12	12	\$11.79
689X2211	(1) 525-2412, (1) 630X248	BI	12	12	\$12.63

## F1807 Stub Out Kit

### 1/2" Lav/Sink Stub Outs With Bracket

- Manage materials more easily
- Save labor costs
- Prevent leaks by using preformed copper
- All copper components are made from Type L copper tube
- For individual product details, see product pages



689X3102

Item Number	Item Description	Pkg Type	Min Qty	Case Qty	Price
<b>16" STUD BAY</b>					
689X3102	(1) 525-1622, (2) 630X246	BI	12	12	\$17.96
689X3202	(1) 525-1622, (2) 630X248	BI	12	12	\$19.64
<b>24" STUD BAY</b>					
689X3112	(1) 525-2422, (2) 630X246	BI	12	12	\$18.70
689X3212	(1) 525-2422, (2) 630X248	BI	12	12	\$20.38



689X5103

### F1807 Stub Out Kit

#### 3/4" Water Heater Stub Outs With Bracket

- Manage materials more easily
- Save labor costs
- Prevent leaks by using preformed copper
- All copper components are made from Type L copper tube
- For individual product details, see product pages

Item Number	Item Description	Pkg Type	Min Qty	Case Qty	Price
689X5103	(1) 525-1623, (2) 630X348	BI	12	12	\$46.47



689X2291

### F1807 Stub Out Kit

#### 1/2" Shower Riser Elbow With Bracket

- Manage materials more easily
- Save labor costs
- Prevent leaks by using preformed copper
- All copper components are made from Type L copper tube
- For individual product details, see product pages

#### Related Products

Shower WallNut™ p 640

Item Number	Item Description	Pkg Type	Min Qty	Case Qty	Price
689X2291	(1) 525-16WLB, (1) 630X248	BI	12	12	\$13.34



694XG32012091

### F1807 Water Heater Connector Kit

- DO NOT use pipe dope on FIP swivel threads
- For individual product details, see product pages
- Pre-manufactured assemblies
- Meets code req. for 18" separation from plastic tubing at water heater
- NL/DZR

Item Number	Item Description	Pkg Type	Min Qty	Case Qty	Price
694XG32012091	(1) 631XG02FP, (1) 633-G3TM15, (1) 633X18	BI	10	10	\$117.80
694XG32012093	(1) 631XG02FP, (1) 633-G3TM11, (1) 633X18	BI	10	10	\$113.91
694XG322120	(1) 633X18, (1) 633XG18FP	BI	10	10	\$86.00

## 1/2" F1807 Branch, Manifold

### 3/4" F1807 × Spun Closed Trunk

- Do not recirculate back through any manifold branch. Do not modify manifold. Doing so will void warranty
- 1" Type L copper trunk
- Branches are 2" on-center
- Great as a secondary manifold
- NL/DZR

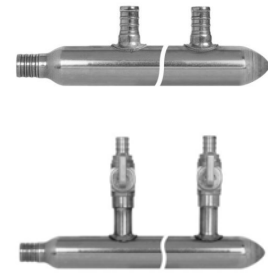

Item Number	Item Description	Pkg Type	Min Qty	Case Qty	Price
<b>COPPER BRANCHES</b>					
672X0390	1/2" F1807, 3 Port	B	25	25	\$23.67
672X0390PK	1/2" F1807, 3 Port	BI	5	5	\$24.17
672X0490	1/2" F1807, 4 Port	B	25	25	\$28.83
672X0490PK	1/2" F1807, 4 Port	BI	5	5	\$29.33
672X0590	1/2" F1807, 5 Port	B	25	25	\$33.99
672X0690	1/2" F1807, 6 Port	B	25	25	\$39.16
672X0690PK	1/2" F1807, 6 Port	BI	5	5	\$39.66
672X0790	1/2" F1807, 7 Port	B	25	25	\$44.32
672X0890	1/2" F1807, 8 Port	B	25	25	\$49.48
672X0990	1/2" F1807, 9 Port	B	25	25	\$54.64
672X1090	1/2" F1807, 10 Port	B	25	25	\$59.81
672X1290	1/2" F1807, 12 Port	B	25	25	\$70.13
<b>BALL VALVE BRANCHES</b>					
672XV0490	1/2" F1807 Ball Valve, 4 Port	BI	1	10	\$116.64
672XV0490PK	1/2" F1807 Ball Valve, 4 Port	BI	5	5	\$117.14
672XV0590	1/2" F1807 Ball Valve, 5 Port	BI	1	10	\$144.68
672XV0690	1/2" F1807 Ball Valve, 6 Port	BI	1	10	\$170.54

Supply

Drainage

Support

Specialties

Appendix

Supply



Drainage



Support

Specialties

Appendix



### 1/2" F1807 Branch, Manifold 3/4" F1807 × 3/4" F1807 Trunk

- Do not recirculate back through any manifold branch. Do not modify manifold. Doing so will void warranty
- 1" Type L copper trunk
- Branches are 2" on-center
- Great as a primary manifold
- NL/DZR

Item Number	Item Description	Pkg Type	Min Qty	Case Qty	Price
<b>STANDARD</b>					
672X0399	1/2" F1807, 3 Port	B	25	25	\$23.14
672X0499	1/2" F1807, 4 Port	B	25	25	\$28.31
<b>672X0499PK</b>	1/2" F1807, 4 Port	BI	6	6	\$28.81
672X0599	1/2" F1807, 5 Port	B	25	25	\$33.47
672X0699	1/2" F1807, 6 Port	B	25	25	\$38.63
672X0699PK	1/2" F1807, 6 Port	BI	6	6	\$39.13
672X0899	1/2" F1807, 8 Port	B	25	25	\$48.96
672X0999	1/2" F1807, 9 Port	B	25	25	\$54.12
672X1299	1/2" F1807, 12 Port	B	25	25	\$69.61
<b>BALL VALVE BRANCHES</b>					
672XV0499	1/2" F1807 Ball Valve, 4 Port	BI	1	10	\$117.21
672XV0599	1/2" F1807 Ball Valve, 5 Port	BI	1	10	\$144.16
672XV0699	1/2" F1807 Ball Valve, 6 Port	BI	1	10	\$170.67
672XV0699-2PK	1/2" F1807 Ball Valve, 6 Port	BI	5	5	\$171.17

### 1/2" F1807 Branch, Manifold 1/2" F1807 × Closed Trunk

- Do not recirculate back through any manifold branch. Do not modify manifold. Doing so will void warranty
- 1" Type L copper trunk
- Branches are 2" on-center

Item Number	Item Description	Pkg Type	Min Qty	Case Qty	Price
672X0380	1/2" F1807, 3 Port	B	25	25	\$23.41
672X0480	1/2" F1807, 4 Port	B	25	25	\$28.57

## 1/2" F1807 Branch, Manifold

### 1/2" F1807 × 3/4" F1807 Trunk

- Do not recirculate back through any manifold branch. Do not modify manifold. Doing so will void warranty
- 1" Type L copper trunk
- Branches are 2" on-center



Item Number	Item Description	Pkg Type	Min Qty	Case Qty	Price
672X0698	1/2" F1807, 6 Port	B	25	25	\$38.37

## 1/2" F1807 Branch, Manifold

### 1" F1807 × Spun Closed Trunk

- Do not recirculate back through any manifold branch. Do not modify manifold. Doing so will void warranty
- 1" Type L copper trunk
- Branches are 2" on-center



Item Number	Item Description	Pkg Type	Min Qty	Case Qty	Price
672X0470	1/2" F1807, 4 Port	B	10	10	\$29.36
672X0670	1/2" F1807, 6 Port	B	10	10	\$39.68
672X0870	1/2" F1807, 8 Port	B	10	10	\$43.18
672X1270	1/2" F1807, 12 Port	B	10	10	\$70.66

## 1/2" F1807 Branch, Manifold

### 3/4" F1807 × 1" F1807 Trunk

- Do not recirculate back through any manifold branch. Do not modify manifold. Doing so will void warranty
- 1" Type L copper trunk
- Branches are 2" on-center

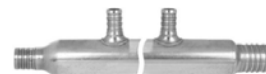

Item Number	Item Description	Pkg Type	Min Qty	Case Qty	Price
672X0497	1/2" F1807, 4 Port	B	10	10	\$28.83
672X0697	1/2" F1807, 6 Port	B	10	10	\$39.16
672X0897	1/2" F1807, 8 Port	B	10	10	\$49.48
672X1297	1/2" F1807, 12 Port	B	10	10	\$70.13

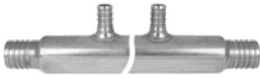

### 1/2" F1807 Branch, Manifold 1" F1807 × 1" F1807 Trunk

- 1" Type L copper trunk
- Branches are 2" on-center
- Do not recirculate back through any manifold branch. Do not modify manifold. Doing so will void warranty

Item Number	Item Description	Pkg Type	Min Qty	Case Qty	Price
672X0477	1/2" F1807, 4 Port	B	10	10	\$29.36
672X0677	1/2" F1807, 6 Port	B	10	10	\$39.68
672X0877	1/2" F1807, 8 Port	B	10	10	\$50.01
672X1277	1/2" F1807, 12 Port	B	10	10	\$70.66



### 1/2" F1807 Branch, Manifold 3/4" MSWT× Spun Closed Trunk

- 3/4" male sweat inlet/outlet can be soldered, pressed or push fit onto
- 1" Type L copper trunk
- Branches are 2" on-center
- Do not recirculate back through any manifold branch. Do not modify manifold. Doing so will void warranty

Item Number	Item Description	Pkg Type	Min Qty	Case Qty	Price
672X0330	1/2" F1807, 3 Port	B	25	25	\$24.89
672X0430	1/2" F1807, 4 Port	B	25	25	\$30.06
672X0630	1/2" F1807, 6 Port	B	25	25	\$40.05
672X0830	1/2" F1807, 8 Port	B	25	25	\$50.38
672X0930	1/2" F1807, 9 Port	B	25	25	\$55.87
672X1230	1/2" F1807, 12 Port	B	25	25	\$71.03

## 1/2" F1807 Branch, Manifold

### 3/4" MSWT × 3/4" FSWT Trunk

- Do not recirculate back through any manifold branch. Do not modify manifold. Doing so will void warranty
- 3/4" male sweat inlet/outlet can be soldered, pressed or push fit onto
- 1" Type L copper trunk
- Branches are 2" on-center
- NL/DZR



672X0431PK

Item Number	Item Description	Pkg Type	Min Qty	Case Qty	Price
<b>COPPER BRANCHES</b>					
672X0431PK	1/2" F1807, 4 Port	BI	5	5	\$33.49
<b>BALL VALVE BRANCHES</b>					
672XV0486PK	1/2" F1807 Ball Valve, 4 Port	BI	5	5	\$115.98

## 1/2" F1807 Branch, Manifold

### 3/4" MSWT × 3/4" MSWT, Extended Trunk

- Do not recirculate back through any manifold branch. Do not modify manifold. Doing so will void warranty
- 3/4" male sweat inlet/outlet can be soldered, pressed or push fit onto
- 1" Type L copper trunk
- Branches are 2" on-center

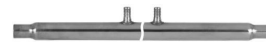

Item Number	Item Description	Pkg Type	Min Qty	Case Qty	Price
672X0433EE	1/2" F1807, 4 Port	B	10	10	\$45.63
672X0633EE	1/2" F1807, 6 Port	B	10	10	\$55.96
672X0833EE	1/2" F1807, 8 Port	B	10	10	\$66.28
672X1033EE	1/2" F1807, 10 Port	B	10	10	\$76.61
672X1233EE	1/2" F1807, 12 Port	B	10	10	\$86.93



## 1/2" F1807 Branch, Manifold

### 1" MSWT × Spun Closed Trunk

- Do not recirculate back through any manifold branch. Do not modify manifold. Doing so will void warranty
- 1" Type L copper trunk can be easily converted to most any connection
- Branches are 2" on-center
- 1" male sweat inlet/outlet can be soldered, pressed or push fit onto

Item Number	Item Description	Pkg Type	Min Qty	Case Qty	Price
672X0440	1/2" F1807, 4 Port	B	25	25	\$32.07
672X0640	1/2" F1807, 6 Port	B	25	25	\$40.86
672X0840	1/2" F1807, 8 Port	B	25	25	\$50.97
672X1240	1/2" F1807, 12 Port	B	25	25	\$72.17



## 1/2" F1807 Branch, Manifold

### 1" MSWT × 1" MSWT Trunk

- Do not recirculate back through any manifold branch. Do not modify manifold. Doing so will void warranty
- 1" Type L copper trunk
- Branches are 2" on-center
- 1" male sweat inlet/outlet can be soldered, pressed or push fit onto

Item Number	Item Description	Pkg Type	Min Qty	Case Qty	Price
672X0644	1/2" F1807, 6 Port	B	25	25	\$42.65
672X0844	1/2" F1807, 8 Port	B	25	25	\$53.03
672X1244	1/2" F1807, 12 Port	B	25	25	\$73.68



## 1/2" F1807 Branch, Manifold

### 1" FSWT × Spun Closed Trunk

- Do not recirculate back through any manifold branch. Do not modify manifold. Doing so will void warranty
- 1" Type L copper trunk
- Branches are 2" on-center
- Valved branches are perfect for centrally located water supply manifolds
- NL/DZR



Item Number	Item Description	Pkg Type	Min Qty	Case Qty	Price
<b>RIGHT TRUNK - LEFT BALL VALVE BRANCHES</b>					
672XV0810	1/2" F1807 Ball Valve, 8 Port	BI	1	10	\$224.83
672XV1010	1/2" F1807 Ball Valve, 10 Port	BI	1	10	\$278.73
672XV1210	1/2" F1807 Ball Valve, 12 Port	BI	1	4	\$332.63
672XV1510	1/2" F1807 Ball Valve, 15 Port	BI	1	5	\$413.48
672XV1810	1/2" F1807 Ball Valve, 18 Port	BI	1	5	\$494.33
<b>LEFT TRUNK - RIGHT BALL VALVE BRANCHES</b>					
672XV0810L	1/2" F1807 Ball Valve, 8 Port	BI	1	10	\$224.83
672XV1010L	1/2" F1807 Ball Valve, 10 Port	BI	1	10	\$278.73
672XV1210L	1/2" F1807 Ball Valve, 12 Port	BI	1	4	\$332.63
672XV1510L	1/2" F1807 Ball Valve, 15 Port	BI	1	5	\$413.48
672XV1810L	1/2" F1807 Ball Valve, 18 Port	BI	1	5	\$494.33

## 1/2" F1807 Branch, Manifold

### 1" MSWT × 1" FSWT Trunk

- Do not recirculate back through any manifold branch. Do not modify manifold. Doing so will void warranty
- 1" Type L copper trunk
- Branches are 2" on-center (unless noted)
- NL/DZR
- 1" male sweat inlet/outlet can be soldered, pressed or push fit onto



Item Number	Item Description	Pkg Type	Min Qty	Case Qty	Price
<b>COPPER BRANCHES</b>					
672X0441PK	1/2" F1807, 4 Port	BI	5	5	\$35.05
<b>BRASS BRANCHES</b>					
672X0242	1/2" F1807, 2 Port	BI	1	10	\$38.19
672X0342	1/2" F1807, 3 Port	BI	1	10	\$53.07
672X0442	1/2" F1807, 4 Port	BI	1	10	\$67.94
672X4L-1131B3	1/2" F1807, 11 Port, 3" O.C.	BI	5	5	\$180.38

Supply

Drainage

Support

Specialties

Appendix

Supply



## 1/2" F1807 Branch, Manifold (Cont)

### 1" MSWT × 1" FSWT Trunk

Item Number	Item Description	Pkg Type	Min Qty	Case Qty	Price
<b>BALL VALVE BRANCHES</b>					
672XV0242	1/2" F1807 Ball Valve, 2 Port	BI	1	10	\$62.34
672XV0342	1/2" F1807 Ball Valve, 3 Port	BI	1	10	\$89.29
672XV0431PK	1/2" F1807 Ball Valve, 4 Port	BI	5	5	\$116.24
672XV0442	1/2" F1807 Ball Valve, 4 Port	BI	1	10	\$116.24
672XV4L-11313	1/2" F1807 Ball Valve, 11 Port, 3" O.C.	BI	1	5	\$313.21
<b>BALANCING/BALL VALVE BRANCHES - LEADED</b>					
672XB0242	1/2" F1807 Balancing Valve, 2 Port	BI	1	10	\$109.15
672XB0342	1/2" F1807 Balancing Valve, 3 Port	BI	1	10	\$155.73
672XB0442	1/2" F1807 Balancing Valve, 4 Port	BI	1	10	\$202.30

Drainage



Support

## 1/2" F1807 Branch, Manifold

### 1" CPVC × Spun Closed Trunk



- Do not recirculate back through any manifold branch. Do not modify manifold. Doing so will void warranty
- 1" Type L copper trunk
- Branches are 2" on-center
- Perfect for hybrid potable water piping systems

Specialties

Item Number	Item Description	Pkg Type	Min Qty	Case Qty	Price
672X03C0	1/2" F1807, 3 Port	B	10	10	\$35.39
672X04C0	1/2" F1807, 4 Port	B	10	10	\$41.10
672X05C0	1/2" F1807, 5 Port	B	10	10	\$45.72
672X06C0	1/2" F1807, 6 Port	B	10	10	\$50.56
672X08C0	1/2" F1807, 8 Port	B	10	10	\$60.88
672X10C0	1/2" F1807, 10 Port	B	10	10	\$71.20
672X12C0	1/2" F1807, 12 Port	B	10	10	\$81.53

Appendix

## 1/2" ComPEX Branch, Manifold

### 1" MSWT × 1" FSWT Trunk

- Do not recirculate back through any manifold branch. Do not modify manifold. Doing so will void warranty
- DO NOT use pipe dope on comp. threads
- 1/2" ComPEX 5/8" O.D. compression branches
- 1" Type L copper trunk
- Branches are 2" on-center
- Brazed branches
- Perfect for hydronic applications
- NL/DZR
- 1" male sweat inlet/outlet can be soldered, pressed or push fit onto

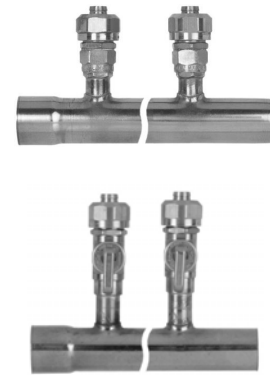

Item Number	Item Description	Pkg Type	Min Qty	Case Qty	Price
<b>STANDARD COMPEX BRANCHES - LEADED</b>					
672C0242	1/2" ComPEX, 2 Port	BI	1	10	\$59.00
672C0342	1/2" ComPEX, 3 Port	BI	1	10	\$81.00
672C0442	1/2" ComPEX, 4 Port	BI	1	10	\$103.00
<b>COMPEX BALL VALVE BRANCHES - LEADED</b>					
672CV0242	1/2" ComPEX Ball Valve, 2 Port	BI	1	10	\$75.00
672CV0342	1/2" ComPEX Ball Valve, 3 Port	BI	1	10	\$105.00
672CV0442	1/2" ComPEX Ball Valve, 4 Port	BI	1	10	\$135.00
<b>COMPEX BALANCING/BALL VALVE BRANCHES - LEADED</b>					
672CB0242	1/2" ComPEX Balancing Valve, 2 Port	BI	1	10	\$115.00
672CB0342	1/2" ComPEX Balancing Valve, 3 Port	BI	1	10	\$165.00
672CB0442	1/2" ComPEX Balancing Valve, 4 Port	BI	1	10	\$215.00

## 1/2" F1807 Branch, Multi-Port Tee

### 3/4" F1807 × Closed Trunk

- One-piece, No Lead brass material
- DZR, SCC resistant

Item Number	Item Description	Pkg Type	Min Qty	Case Qty	Price
<b>NL/DZR BRASS</b>					
672XGT0390	1/2" F1807, 3 Port, 1/Bag	BI	10	100	\$17.15
672XGT0490	1/2" F1807, 4 Port, 1/Bag	BI	10	100	\$21.26



672XGT0390

Supply

Drainage

Support

Specialties

Appendix

**1/2" F1807 Branch, Multi-Port Tee**  
**3/4" F1807 × 3/4" F1807 Trunk**



672XGT0399

- One-piece, No Lead brass material
- DZR, SCC resistant

Item Number	Item Description	Pkg Type	Min Qty	Case Qty	Price
<b>NL/DZR BRASS</b>					
672XGT0399	1/2" F1807, 3 Port, 1/Bag	BI	10	100	\$17.15
672XGT0499	1/2" F1807, 4 Port, 1/Bag	BI	10	100	\$21.26

Supply

Drainage

Support

Specialties

Appendix

## Crimp Tool

- Compact tools allow for one-hand crimping
- Go/No-Go gauge provided with every model
- Also work on PB F1380 tube and fittings

Item Number	Item Description	Pkg Type	Min Qty	Case Qty	Price
<b>STANDARD</b>					
305-7023	1/2"- 3/4", Straight Handle	Bl	1	10	\$167.94
305-7040	1", Straight Handle	Bl	1	10	\$177.82
305-7050	1-1/4", Straight Handle	Bl	1	10	\$187.14
305-7095	5-N-1 Combo Kit w/ Case (3/8"- 1/2"- 5/8"- 3/4"- 1") Straight Handle	Bl	1	5	\$249.97
<b>COMPACT</b>					
305-7110	3/8" w/ Case	Bl	1	8	\$128.43
305-7120	1/2" w/ Case	Bl	1	8	\$128.43
305-7123	1/2"- 3/4" w/ Case	Bl	1	8	\$163.85
305-7130	3/4" w/ Case	Bl	1	8	\$128.43
<b>GO/NO-GO GAUGE</b>					
305-995	3/8", 1/2", 5/8", 3/4", 1", 1/Bag	Bl	1	200	\$8.73



305-7095



305-7120

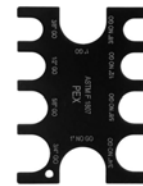

305-995

Supply

Drainage

Support

Specialties

Appendix

Supply

Drainage

Support

Specialties

Appendix



603Q2



280-A266537

### Tube Stiffener

· When installing PEX tube, a tube stiffener must be inserted into PEX tubing end prior to installation of the PDQ™ fitting or valve

Item Number	Item Description	Pkg Type	Min Qty	Case Qty	Price
<b>POLYPROPYLENE</b>					
603Q2	1/2", 6/Bag	CI	15	15	\$4.40
603Q3	3/4", 6/Bag	CI	15	15	\$7.26
603Q4	1", 6/Bag	CI	15	15	\$9.72
<b>STAINLESS STEEL</b>					
280-A266537	1/2"	B	10	2500	\$2.35
280-A266607	3/4"	B	50	1000	\$8.85
280-A266617	1"	B	50	1000	\$10.06
280-A266627	1-1/4"	B	25	25	\$13.73
280-A266637	1-1/2"	B	25	25	\$14.67

## Crimp Ring Removal Tool

- Use only on Brass or Stainless Steel fittings
- Two cuts on copper ring allows user to reclaim fitting
- Cutting blade only penetrates the copper ring and pipe
- Suitable for use on ½" through 1" PEX pipe sizes
- Allows fitting recovery without damaging the sealing surfaces of the fitting



305-999

Item Number	Item Description	Pkg Type	Min Qty	Case Qty	Price
305-999	3/8" - 1"	BI	1	40	\$72.70

## V-Sleeve™ Compression Tool

- Exclusively for installing Sioux Chief's V-Sleeve™ stainless steel PEX compression system



305-82TX

Item Number	Item Description	Pkg Type	Min Qty	Case Qty	Price
<b>STANDARD</b>					
305-802	1/2" Straight Handle	BI	1	20	\$192.00
305-803	3/4" Straight Handle	BI	1	20	\$192.00
305-804	1" Straight Handle	BI	1	10	\$212.00
305-82TX	1/2" Straight Handle	BI	1	10	\$167.95
305-84TX	1" Straight Handle	BI	1	10	\$177.82
<b>COMPACT</b>					
305-92TX	1/2"	BI	1	10	\$154.12
<b>GO/NO-GO GAUGE</b>					
305-85TX	1/2", 3/4", & 1"	BI	1	12	\$11.47



305-92TX



305-85TX

## Plastic Tube Cutter

- Quickly cut PEX, PVC, CPVC and other poly pipe or non-metallic hose
- For 1-1/8" O.D. tube or smaller
- Replacement blades available



304-08

Item Number	Item Description	Pkg Type	Min Qty	Case Qty	Price
304-08	Plastic Tube And Hose Cutter - 2-1/4" Blade Length	BI	12	72	\$24.37
304-1	Replacement Blade For 304-08	BI	1	50	\$9.07
304-12	Plastic Tube And Hose Cutter - 3-1/4" Blade Length	BI	12	12	\$24.37
304-12B	Replacement Blade For 304-12	BI	1	12	\$10.52

Supply

Drainage

Support

Specialties

Appendix



304-11

## Ratchet Tube Cutter

- For use with PVC and polyethylene piping
- Easy ratchet cutting action

Item Number	Item Description	Pkg Type	Min Qty	Case Qty	Price
304-11	Cuts 3/8" Thru 1-1/4" Diameter Tube/Pipe	BI	12	12	\$29.65
305-A139092	Cuts 1-1/4" Thru 2" Diameter Tube/Pipe	BI	1	10	\$309.26
305-A139092B	Replacement Blade for 305-A139092	BI	1	25	\$35.62



# PowerPEX<sup>®</sup> Systems for ASTM F2159

## ASTM F2159 - Fittings, Adapters & Connectors

Sioux Chief's PowerPEX<sup>®</sup> ASTM F2159 polymer fittings utilize high-performance, engineered polymer materials designed for use in potable water applications. Extensive research and testing has been performed on the quality and durability of these materials when used in potable water applications. ASTM F2159 fittings are designed for use with a copper crimp ring or the F877 V-Sleeve™, both of which provide 360° of compression around the sealing barbs. Stainless steel cinch clamps can also be used with the PowerPex ASTM F2159 fitting system.



Sioux Chief is transitioning from white fittings to black fittings for all ASTM F2159. This transition will take place through 2022 and may extend beyond. Fitting orders may include a mixture of both fitting colors if necessary.

**Note:** There are special considerations for using polymer fittings. Refer to the Sioux Chief PowerPEX installation manual for more information on limitations of polymer fitting systems.



**649X2**  
Page 51



**649TX2**  
Page 51



**649Y2**  
Page 51



**642PX2**  
Page 51



**641PX222**  
Page 52



**645PX3**  
Page 52



**640PX12**  
Page 52



**646PX3**  
Page 53



**637PX20**  
Page 53



**632PX222M**  
Page 53



**637PX25**  
Page 53

## Crimp Ring

- For use with PEX SDR9 tube only
- Do not use with PB tube
- Pure, annealed copper rings

### Related Products

Crimp Tool p 45

Item Number	Item Description	Pkg Type	Min Qty	Case Qty	Price
<b>COPPER</b>					
649X1	3/8" PEX	B	100	1000	\$0.34
649X2	1/2" PEX	B	100	1000	\$0.27
649X3	3/4" PEX	B	100	500	\$0.36
649X4	1" PEX	B	25	250	\$0.90



649X2

## V-Sleeve™

### PEX Compression Sleeve

Item Number	Item Description	Pkg Type	Min Qty	Case Qty	Price
<b>STAINLESS STEEL</b>					
649TX2	1/2" PEX	B	100	1000	\$0.51
649TX3	3/4" PEX	B	100	500	\$0.67
649TX4	1" PEX	B	25	250	\$1.45



649TX2

## Cinch Clamp

Item Number	Item Description	Pkg Type	Min Qty	Case Qty	Price
<b>STAINLESS STEEL</b>					
649Y1PK1	3/8" PEX, 10/Bag	BI	1	200	\$5.37
649Y2	1/2" PEX, 100/Bag	BI	1	20	\$50.20
649Y3	3/4" PEX, 100/Bag	BI	1	10	\$58.94
649Y4PK1	1" PEX, 10/Bag	BI	1	10	\$9.47



649Y2

## F2159 Poly Elbow

- Use elbows when a tight radius 90° turn is needed

Item Number	Item Description	Pkg Type	Min Qty	Case Qty	Price
642PX2	1/2" × 1/2", 25/Bag	B	1	10	\$24.63
642PX3	3/4" × 3/4", 25/Bag	B	1	10	\$36.93
642PX32	3/4" × 1/2", 25/Bag	B	1	10	\$33.85
642PX4	1" × 1", 25/Bag	B	1	10	\$99.29



642PX3

Supply

Drainage

Support

Specialties

Appendix

Supply

Drainage

Support

Specialties

Appendix



641PX333



641PX322



641PX334



645PX2



640PX13

### F2159 Poly Tee

· A wide selection of tee configurations

Item Number	Item Description	Pkg Type	Min Qty	Case Qty	Price
<b>STANDARD TEE</b>					
641PX222	1/2" × 1/2" × 1/2", 50/Bag	B	1	10	\$61.59
641PX333	3/4" × 3/4" × 3/4", 20/Bag	B	1	10	\$41.88
641PX444	1" × 1" × 1", 20/Bag	B	1	10	\$83.75
<b>REDUCING TEE</b>					
641PX322	3/4" × 1/2" × 1/2", 20/Bag	B	1	10	\$39.40
641PX323	3/4" × 1/2" × 3/4", 20/Bag	B	1	10	\$39.40
641PX332	3/4" × 3/4" × 1/2", 20/Bag	B	1	10	\$39.40
641PX433	1" × 3/4" × 3/4", 20/Bag	B	1	10	\$86.22
641PX434	1" × 3/4" × 1", 20/Bag	B	1	10	\$86.22
641PX442	1" × 1" × 1/2", 20/Bag	B	1	10	\$83.75
641PX443	1" × 1" × 3/4", 20/Bag	B	1	10	\$83.75
<b>BULLHEAD TEE</b>					
641PX223	1/2" × 1/2" × 3/4", 20/Bag	B	1	10	\$39.40
641PX334	3/4" × 3/4" × 1", 20/Bag	B	1	10	\$86.22

### F2159 Poly Coupling

Item Number	Item Description	Pkg Type	Min Qty	Case Qty	Price
645PX2	1/2" × 1/2", 25/Bag	B	1	20	\$17.71
645PX3	3/4" × 3/4", 25/Bag	B	1	20	\$24.63
645PX32	3/4" × 1/2", 25/Bag	B	1	20	\$28.49
645PX4	1" × 1", 25/Bag	B	1	10	\$49.27
645PX42	1" × 1/2", 25/Bag	B	1	10	\$60.03
645PX43	1" × 3/4", 25/Bag	B	1	10	\$43.10

### F2159 Poly Plug

Item Number	Item Description	Pkg Type	Min Qty	Case Qty	Price
640PX12	1/2" F2159, 50/Bag	B	1	20	\$35.53
640PX13	3/4" F2159, 25/Bag	B	1	20	\$29.89
640PX14	1" F2159, 25/Bag	B	1	10	\$42.81

## F2159 Poly Straight Adapter

### MIP

- Transition from thread fitting to PEX tubing

Item Number	Item Description	Pkg Type	Min Qty	Case Qty	Price
646PX2	1/2" F2159 × 1/2" MIP, 25/Bag	B	1	10	\$31.88
646PX23	3/4" F2159 × 1/2" MIP, 25/Bag	B	1	10	\$40.41
646PX3	3/4" F2159 × 3/4" MIP, 25/Bag	B	1	10	\$41.19
646PX32	1/2" F2159 × 3/4" MIP, 25/Bag	B	1	10	\$43.52
646PX4	1" F2159 × 1" MIP, 25/Bag	B	1	10	\$68.40



646PX3

## F2159 Poly Straight Adapter

### FIP Swivel

- Nose cone seal. Do not use thread sealant
- Tabs perfectly position crimp ring or sleeve over sealing barbs every time

Item Number	Item Description	Pkg Type	Min Qty	Case Qty	Price
637PX20	1/2" F2159 × 1/2" FIP, 50/Bag	BI	1	10	\$88.07



637PX20

## F2159 Poly Elbow Adapter

### MIP Elbow

- Transition from thread fitting to PEX tubing

Item Number	Item Description	Pkg Type	Min Qty	Case Qty	Price
632PX222M	1/2" F2159 × 1/2" MIP, 25/Bag	B	1	10	\$57.36
632PX232M	3/4" F2159 × 1/2" MIP, 25/Bag	B	1	10	\$64.22
632PX332M	3/4" F2159 × 3/4" MIP, 25/Bag	B	1	10	\$71.07



632PX232M

## F2159 Poly Elbow Adapter

### FIP Swivel Elbow

- Nose cone seal. Do not use thread sealant

Item Number	Item Description	Pkg Type	Min Qty	Case Qty	Price
637PX25	1/2" F2159 × 1/2" FIP Swivel, 50/Bag	B	1	10	\$138.62



637PX25

Supply

Drainage

Support

Specialties

Appendix



# **PowerPEX<sup>®</sup>** **Systems** **for ASTM F1960**

**ASTM F1960 - Brass Fittings, Adapters & Connectors**

**ASTM F1960 - Preformed Copper**

**ASTM F1960 - Valves**

**ASTM F1960 - Kits**

**ASTM F1960 Manifolds**

**ASTM F1960 - PPSU Fittings,  
Adapters & Connectors**

**ASTM F1960 - Expansion Tools**



The Sioux Chief PowerPEX<sup>®</sup> ASTM F1960 fitting system has a larger I.D., which provides higher flow rates than other insert-fitting systems. Expansion tools are used to expand the tube and F1960 PEX rings, which then shrink to compress over fitting barbs.

**Note:** All expansion joints made using PowerPEX Type-B tubing MUST be made with a self-rotating, power expansion tool to eliminate weak spots and avoid improper expansion rates.



**649W3**  
Page 57



**642WG3**  
Page 57



**641WG222**  
Page 57



**645WG2**  
Page 58



**645WGC2**  
Page 58



**644WG2**  
Page 60



**646WG3**  
Page 60



**647WG2E3**  
Page 61



**632WG332**  
Page 62



**630WG248E**  
Page 63



**638WG208**  
Page 64



**632W273X**  
Page 64



**631WG02**  
Page 64



**633WG18FP**  
Page 65



**648WG2FPPK1**  
Page 66



**118W206**  
Page 67



**689WG3202**  
Page 68



**672WG0490**  
Page 70



**672WGT0499**  
Page 73



**642WP3**  
Page 74



**641WP222**  
Page 74



**646WP3**  
Page 76



**637WP20**  
Page 76



**672WP0390**  
Page 77



**305-W23KIT**  
Page 78



## F1960 Expansion Ring

- For use with PEX SDR9 tube only

### Related Products

F1960 Expansion Tools p 78

Item Number	Item Description	Pkg Type	Min Qty	Case Qty	Price
649W2	1/2" F1960	B	50	1000	\$0.29
649W3	3/4" F1960	B	50	500	\$0.51
649W4	1" F1960	B	25	250	\$0.92
649WP2	1/2" F1960, PEX-A	B	50	1000	\$0.57
649WP3	3/4" F1960, PEX-A	B	50	500	\$1.02
649WP4	1" F1960, PEX-A	B	25	250	\$1.84
649WP5	1-1/4" F1960, PEX-A	B	10	10	\$2.17
649WP6	1-1/2" F1960, PEX-A	B	10	10	\$2.23
649WP7	2" F1960, PEX-A	B	10	10	\$4.06



649W2

## F1960 Elbow

- Full flow - no restriction
- One-piece no lead brass

Item Number	Item Description	Pkg Type	Min Qty	Case Qty	Price
<b>NL/DZR BRASS</b>					
642WG2	1/2" × 1/2"	B	25	25	\$8.97
642WG3	3/4" × 3/4"	B	25	25	\$17.92
642WG4	1" × 1"	B	25	25	\$24.51



642WG2

## F1960 Tee

- Full flow - no restriction
- One-piece no lead brass

Item Number	Item Description	Pkg Type	Min Qty	Case Qty	Price
<b>STANDARD TEE - NL/DZR BRASS</b>					
641WG222	1/2" × 1/2" × 1/2"	B	50	50	\$11.92
641WG333	3/4" × 3/4" × 3/4"	B	20	20	\$19.16
641WG444	1" × 1" × 1"	B	20	20	\$33.56
<b>REDUCING TEE - NL/DZR BRASS</b>					
641WG322	3/4" × 1/2" × 1/2"	B	20	20	\$13.78
641WG323	3/4" × 1/2" × 3/4"	B	20	20	\$15.52
641WG332	3/4" × 3/4" × 1/2"	B	20	20	\$17.11
641WG433	1" × 3/4" × 3/4"	B	20	20	\$33.56
641WG442	1" × 1" × 1/2"	B	20	20	\$33.89
641WG443	1" × 1" × 3/4"	B	20	20	\$35.16

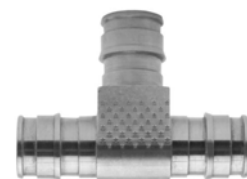

641WG222



641WG332



641WG223

### F1960 Tee (Cont)

Item Number	Item Description	Pkg Type	Min Qty	Case Qty	Price
<b>BULLHEAD TEE - NL/DZR BRASS</b>					
641WG223	1/2" × 1/2" × 3/4"	B	20	20	\$13.63
641WG334	3/4" × 3/4" × 1"	B	20	20	\$39.98



645WG2

### F1960 Coupling

· One-piece no lead brass

Item Number	Item Description	Pkg Type	Min Qty	Case Qty	Price
<b>NL/DZR BRASS</b>					
645WG2	1/2" × 1/2"	B	100	100	\$5.81
645WG3	3/4" × 3/4"	B	50	50	\$9.26
645WG32	3/4" × 1/2"	B	50	50	\$9.99
645WG4	1" × 1"	B	25	25	\$19.03
645WG43	1" × 3/4"	B	25	25	\$16.12



645WGC2

### F1960 Straight Adapter

#### CPVC, CTS

· A quick and easy transition



645WGC5

Item Number	Item Description	Pkg Type	Min Qty	Case Qty	Price
<b>NL/DZR BRASS CPVC CUP</b>					
645WGC2	1/2" F1960 × 1/2" CPVC	B	50	50	\$10.49
645WGC3	3/4" F1960 × 3/4" CPVC	B	50	50	\$17.93
645WGC4	1" F1960 × 1" CPVC	B	20	20	\$25.87
<b>NL/DZR CPVC CUP</b>					
645WGC5	1-1/4" F1960 × 1-1/4" CPVC - Assembly	B	5	5	\$70.70
645WGC6	1-1/2" F1960 × 1-1/2" CPVC - Assembly	B	5	5	\$91.40
645WGC7	2" F1960 × 2" CPVC - Assembly	B	5	5	\$148.08

## F1960 Straight Adapter

### CPVC - IPS Gray

- A quick and easy transition

Item Number	Item Description	Pkg Type	Min Qty	Case Qty	Price
<b>NL/DZR CPVC CUP</b>					
645WGC93	3/4" F1960 × 3/4" Sch 40 CPVC	B	50	50	\$18.14
645WGC94	1" F1960 × 1" Sch 40 CPVC	B	20	20	\$29.38
645WGC95	1-1/4" F1960 × 1-1/4" Sch 40 CPVC	B	10	10	\$73.29



645WGC93

## F1960 Straight Adapter

### PVC

- Perfect for hooking up PEX underground water service lines to PVC in-house piping systems
- Cold water applications only

Item Number	Item Description	Pkg Type	Min Qty	Case Qty	Price
<b>NL/DZR PVC CUP</b>					
645WG3P	3/4" F1960 × 3/4" PVC	B	50	50	\$15.97
645WG4P	1" F1960 × 1" PVC	B	20	20	\$29.38



645WG4P

## F1960 Straight Adapter

### Male Sweat

- Full flow - no restriction
- One-piece no lead brass

Item Number	Item Description	Pkg Type	Min Qty	Case Qty	Price
<b>NL/DZR BRASS</b>					
643WG2	1/2" F1960 × 1/2" MSWT	B	100	100	\$4.45
643WG23	3/4" F1960 × 1/2" MSWT	B	50	50	\$9.99
643WG3	3/4" F1960 × 3/4" MSWT	B	50	50	\$9.52
643WG32	1/2" F1960 × 3/4" MSWT	B	50	50	\$8.58
643WG4	1" F1960 × 1" MSWT	B	25	25	\$18.48
643WG43	3/4" F1960 × 1" MSWT	B	25	25	\$18.72
643WG5	1-1/4" F1960 × 1-1/4" MSWT	B	5	5	\$39.37
643WG6	1-1/2" F1960 × 1-1/2" MSWT	B	5	5	\$64.83
643WG7	2" F1960 × 2" MSWT	B	5	5	\$193.58



643WG2

Supply

Drainage

Support

Specialties

Appendix



644WG2

## F1960 Straight Adapter

### Female Sweat

- One-piece no lead brass
- Full flow - no restriction

Item Number	Item Description	Pkg Type	Min Qty	Case Qty	Price
<b>NL/DZR BRASS</b>					
644WG2	1/2" F1960 × 1/2" FSWT	B	100	100	\$4.51
644WG23	3/4" F1960 × 1/2" FSWT	B	50	50	\$15.50
644WG3	3/4" F1960 × 3/4" FSWT	B	50	50	\$9.68
644WG32	1/2" F1960 × 3/4" FSWT	B	50	50	\$8.41
644WG4	1" F1960 × 1" FSWT	B	25	25	\$16.77
644WG43	3/4" F1960 × 1" FSWT	B	25	25	\$19.37
644WG5	1-1/4" F1960 × 1-1/4" FSWT	B	5	5	\$45.18
644WG6	1-1/2" F1960 × 1-1/2" FSWT	B	5	5	\$66.13
644WG7	2" F1960 × 2" FSWT	B	5	5	\$194.87



646WG2

## F1960 Straight Adapter

### MIP

- One-piece no lead brass

Item Number	Item Description	Pkg Type	Min Qty	Case Qty	Price
<b>NL/DZR BRASS</b>					
646WG2	1/2" F1960 × 1/2" MIP	B	100	100	\$6.48
646WG3	3/4" F1960 × 3/4" MIP	B	25	25	\$12.25
646WG32	1/2" F1960 × 3/4" MIP	B	25	25	\$15.83
646WG34	1" F1960 × 3/4" MIP	B	25	25	\$25.32
646WG4	1" F1960 × 1" MIP	B	25	25	\$24.63
646WG43	3/4" F1960 × 1" MIP	B	25	25	\$23.89
646WG5	1-1/4" F1960 × 1-1/4" MIP	B	5	5	\$55.41
646WG6	1-1/2" F1960 × 1-1/2" MIP	B	5	5	\$76.70
646WG7	2" F1960 × 2" MIP	B	5	5	\$210.36

## F1960 Straight Adapter

### FIP

- One-piece no lead brass

#### Related Products

Shower Arm Test Plug p 467

Item Number	Item Description	Pkg Type	Min Qty	Case Qty	Price
<b>NL/DZR BRASS</b>					
647WG2	1/2" F1960 × 1/2" FIP	B	50	50	\$12.70
647WG23	3/4" F1960 × 1/2" FIP	B	50	50	\$14.31
647WG3	3/4" F1960 × 3/4" FIP	B	50	50	\$14.74
647WG32	1/2" F1960 × 3/4" FIP	B	25	25	\$20.37
647WG4	1" F1960 × 1" FIP	B	25	25	\$30.01
647WG43	3/4" F1960 × 1" FIP	B	25	25	\$46.16
647WG5	1-1/4" F1960 × 1-1/4" FIP	B	5	5	\$56.39
647WG6	1-1/2" F1960 × 1-1/2" FIP	B	5	5	\$114.69
647WG7	2" F1960 × 2" FIP	B	5	5	\$253.07



647WG2

## F1960 Elbow Adapter

### MIP

- One-piece no lead brass
- Full flow - no restriction

Item Number	Item Description	Pkg Type	Min Qty	Case Qty	Price
<b>NL/DZR BRASS</b>					
632WG222M	1/2" F1960 × 1/2" MIP	B	50	50	\$12.77
632WG222MPK2	1/2" F1960 × 1/2" MIP, 2/Bag	BI	10	10	\$25.84



632WG222M

## F1960 Elbow Adapter

### Tub/Shower Elbow

- One-piece no lead brass
- For use on shower risers, tub spouts, and non-pressure fitting applications

#### Related Products

Shower Arm Test Plug p 467

WiderSlider™ Adjustable Bracket p 529

Item Number	Item Description	Pkg Type	Min Qty	Case Qty	Price
<b>NL/DZR BRASS DROP EAR</b>					
647WG2E3	1/2" F1960 × 1/2" FIP	B	50	50	\$17.53



647WG2E3

Supply

Drainage

Support

Specialties

Appendix



632WG332

### F1960 Elbow Adapter

#### Male Sweat

- Full flow - no restriction
- One-piece no lead brass

Item Number	Item Description	Pkg Type	Min Qty	Case Qty	Price
<b>NL/DZR BRASS</b>					
632WG332	3/4" F1960 × 3/4" MSWT	B	25	25	\$12.37



632WG335

### F1960 Elbow Adapter

#### Female Sweat

- One-piece no lead brass
- Full flow - no restriction

Item Number	Item Description	Pkg Type	Min Qty	Case Qty	Price
<b>NL/DZR BRASS</b>					
632WG335	3/4" F1960 × 3/4" FSWT	B	25	25	\$15.48



615W216

### Wal-Let™ - F1960

#### Wall Termination Fitting

Item Number	Item Description	Pkg Type	Min Qty	Case Qty	Price
<b>LEADED</b>					
615W216	1/2" FIP × 1/2" F1960	B	25	25	\$27.16

### F1960 Stub Out Elbow

- Accepts sweat, push-fitting and compression valves
- Combines easy adapting of copper stub outs with easy installation of F1960 PEX system
- NL/DZR

Item Number	Item Description	Pkg Type	Min Qty	Case Qty	Price
630WG2138	1/2" F1960, 13" x 8"	B	50	50	\$18.38
630WG2412	1/2" F1960, 4" x 12"	B	50	50	\$17.27
630WG248	1/2" F1960, 4" x 8"	B	50	50	\$11.22
630WG248PK1	1/2" F1960, 4" x 8", 10/Box	BI	10	10	\$11.47
630WG348	3/4" F1960, 5" x 8"	B	25	25	\$25.88
630WG4612	1" F1960, 6" x 12"	B	25	25	\$45.22



630WG248

### F1960 Stub Out Elbow

#### Square O Strap

- Accepts sweat, push-fitting and compression valves
- Combines easy adapting of copper stub outs with easy installation of F1960 PEX system
- Square O Straps affix easily to the Edge bracket or any backing board to provide solid installations
- Multiple mounting holes allow for installations on sides, bottom, or top
- NL/DZR

Item Number	Item Description	Pkg Type	Min Qty	Case Qty	Price
630WG248E	1/2" F1960, 4" x 8" w/ Strap	B	25	25	\$12.41
630WG248EPK1	1/2" F1960, 4" x 8" w/Strap, 10/Box	BI	10	10	\$12.66
630WG348E	3/4" F1960, 5" x 8" w/ Strap	B	25	25	\$27.47
630WG4612E	1" F1960, 6" x 12" w/ Strap	B	10	10	\$46.78

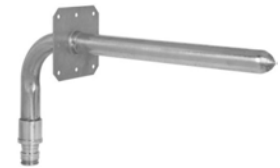

630WG248E

### F1960 Stub Out Elbow

#### Double Stub Out

- Brazed stub out joint will not fracture
- NL/DZR

#### Related Products

3-Valve Kitchen Supply Box p 195

Item Number	Item Description	Pkg Type	Min Qty	Case Qty	Price
630WGD288E	1/2" F1960, 8" x 8" x 8" w/ Strap	B	25	25	\$29.45



630WGD288E

Supply

Drainage

Support

Specialties

Appendix



638WG212E

### F1960 Bullet™

- Not to be used as permanent air chambers
- Type L copper
- Accepts sweat, push-fitting and compression valves
- Bracketed - Perfect for stubbing up through floor for closets or lavs
- NL/DZR

Item Number	Item Description	Pkg Type	Min Qty	Case Qty	Price
<b>STANDARD</b>					
638WG208	1/2" F1960, 8"	B	50	50	\$11.61
638WG215	1/2" F1960, 15"	B	50	50	\$21.78
<b>SPUN CLOSED WITH STRAP</b>					
638WG212E	1/2" F1960, 12" Long, 8" Stub Out	B	50	50	\$18.78



632W273X

### F1960 Tub/Shower Pressure Connector

- DO NOT use pipe dope on FIP swivel threads
- Perfect for sweat connection to standard tub/shower valves
- MIP and FIP swivel connections mean no torch at the tub/shower valve
- Made from Type L copper tube
- Elongated tailpiece allows for rigid bracket attachment
- NL/DZR

Item Number	Item Description	Pkg Type	Min Qty	Case Qty	Price
632W273X	1/2" F1960 × 1/2" MIP Swivel, 7" × 3"	B	50	50	\$17.65
632WG263	1/2" F1960 × 1/2" MSWT, 6" × 2-1/4"	B	50	50	\$10.53
632WG263Y	1/2" F1960 × 1/2" FIP Swivel, 6" × 3"	B	50	50	\$14.38



631WG02



631WG02FP

### F1960 Water Heater Connector

#### FIP Swivel Elbow

- DO NOT use pipe dope on FIP swivel threads
- Brass FIP swivel nut includes gasket
- Dielectric fitting
- Lead-free solder joint
- 3/4" Type L copper
- NL/DZR

Item Number	Item Description	Pkg Type	Min Qty	Case Qty	Price
<b>STANDARD</b>					
631WG02	3/4" F1960 × 3/4" FIP Swivel	B	25	25	\$19.26
<b>VALVED, FULL PORT</b>					
631WG02FP	3/4" F1960 × 3/4" FIP Swivel	B	12	12	\$54.26



## F1960 Water Heater Connector

### FIP Swivel Straight

- DO NOT use pipe dope on FIP swivel threads
- Full flow – no restriction
- Lead-free solder joint
- Made from Type L copper tube
- Brass FIP swivel nut includes gasket
- NL/DZR

Item Number	Item Description	Pkg Type	Min Qty	Case Qty	Price
<b>STANDARD</b>					
633WG18	3/4" F1960 × 3/4" FIP Swivel, 18"	B	25	25	\$28.00
633WG18PK1	3/4" PEX F1960 × 3/4" FIP Swivel, 18", 10/Box	BI	10	10	\$28.25
<b>VALVED, FULL PORT</b>					
633WG18FP	3/4" F1960 × 3/4" FIP Swivel, 18"	B	10	10	\$63.00
633WG18FPT	3/4" F1960 × 3/4" FIP Swivel, w/ 3/4" FIP Branch, 18"	B	10	10	\$77.00
633WG306FP	3/4" PEX F1960 × 3/4" FIP Swivel, 6"	B	10	10	\$51.33
<b>THERMAL EXPANSION VALVE, FULL PORT</b>					
633WG18FRV	3/4" F1960 × 3/4" FIP Swivel, w/ Pressure Relief 3/8" Comp., 18"	B	10	10	\$73.00
633WG18HRV	3/4" F1960 × 3/4" FIP Swivel, w/ Pressure Relief 3/8" Hose Barb, 18"	B	10	10	\$73.00
633WG18WRV	3/4" F1960 × 3/4" FIP Swivel, w/ Pressure Relief 1/2" F1960, 18"	B	10	10	\$73.00
<b>ADJUSTABLE REPLACEMENT RELIEF PORT</b>					
648-ARW	1/8" MIP × 1/2" F1960, 80-125 PSI	BI	6	6	\$10.30

## F1960 Water Heater Connector

### Flexible Copper FIP Swivel

- DO NOT use pipe dope on FIP swivel threads
- Brass FIP swivel nut includes gasket
- Flexible dielectric fitting works well in tight spaces
- Lead-free solder joint
- NL/DZR
- Do not twist or kink flexible connector

Item Number	Item Description	Pkg Type	Min Qty	Case Qty	Price
<b>STANDARD</b>					
634WG418	3/4" F1960 × 3/4" FIP Swivel, 18"	B	25	25	\$24.69
<b>VALVED, FULL PORT</b>					
634WG418FP	3/4" F1960 × 3/4" FIP Swivel, 18"	B	25	25	\$58.39



633WG18



634WG418



634WG418FP

Supply

Drainage

Support

Specialties

Appendix

Supply



648WG2FPPK1

Drainage



648WG5FP

Support



648-3SW

Specialties



648WG3WRV

Appendix



648WG-3

### F1960 Brass Ball Valve

- NL/DZR Brass

Item Number	Item Description	Pkg Type	Min Qty	Case Qty	Price
<b>STANDARD</b>					
648WG2FPPK1	1/2" F1960	BI	10	100	\$13.67
648WG3FPPK1	3/4" F1960	BI	10	100	\$28.52
648WG4FPPK1	1" F1960	BI	12	60	\$43.37
<b>FULL PORT</b>					
648WG5FP	1-1/4" F1960	B	5	5	\$162.64
648WG6FP	1-1/2" F1960	B	1	1	\$216.57
648WG7FP	2" F1960	B	1	1	\$354.14
<b>FULL PORT WITH DRAIN</b>					
648WG2FPD	1/2" F1960	B	10	10	\$47.01
648WG3FPD	3/4" F1960	B	6	6	\$66.28
<b>FULL PORT FIPS X F1960</b>					
648-3SW	3/4" FIPS x 3/4" F1960	BI	1	5	TBD
<b>THERMAL EXPANSION VALVE - 125 PSI</b>					
648WG3WRV	3/4" F1960 × 3/4" F1960, 1/2" F1960 Port	BI	6	6	\$45.00

### F1960 Brass Ball Valve

#### Female Sweat

- Chrome-plated ball, blowout-proof stem
- NL/DZR Brass

Item Number	Item Description	Pkg Type	Min Qty	Case Qty	Price
<b>FULL PORT</b>					
648WG-2	1/2" F1960 × 1/2" FSWT	BI	6	108	\$11.62
648WG-3	3/4" F1960 × 3/4" FSWT	BI	6	72	\$20.02
648WG-4	1" F1960 × 1" FSWT	BI	6	36	\$25.24

### F1960 Silcock

Item Number	Item Description	Pkg Type	Min Qty	Case Qty	Price
<b>LEADED</b>					
117W2	1/2" F1960	BI	10	100	\$21.36



117W2

## F1960 Frost-Proof Anti-Siphon Sillcock

**Related Products**

Frost-Proof Sillcock Replacement Parts p 124



118W208

Item Number	Item Description	Pkg Type	Min Qty	Case Qty	Price
<b>MULTI-TURN - LEADED</b>					
118W204	1/2" F1960 × 3/4" MHT, 4"	BI	1	40	\$32.80
118W206	1/2" F1960 × 3/4" MHT, 6"	BI	1	40	\$34.07
118W208	1/2" F1960 × 3/4" MHT, 8"	BI	1	40	\$34.70
118W210	1/2" F1960 × 3/4" MHT, 10"	BI	1	40	\$36.79
118W212	1/2" F1960 × 3/4" MHT, 12"	BI	1	40	\$38.05

- Supply
- Drainage
- Support
- Specialties
- Appendix



689WG2201

### F1960 Stub Out Kit

#### 1/2" Water Closet Stub Out With Bracket

- Manage materials more easily
- Save labor costs
- Prevent leaks by using preformed copper
- All copper components are made from Type L copper tube
- For individual product details, see product pages
- NL/DZR

Item Number	Item Description	Pkg Type	Min Qty	Case Qty	Price
<b>16" STUD BAYS</b>					
689WG2201	(1) 525-1612, (1) 630WG248	BI	12	12	\$16.68
<b>24" STUD BAYS</b>					
689WG2211	(1) 525-2412, (1) 630WG248	BI	12	12	\$17.43



689WG3202

### F1960 Stub Out Kit

#### 1/2" Lav/Sink Stub Outs With Bracket

- Manage materials more easily
- Save labor costs
- Prevent leaks by using preformed copper
- All copper components are made from Type L copper tube
- For individual product details, see product pages
- NL/DZR

Item Number	Item Description	Pkg Type	Min Qty	Case Qty	Price
<b>16" STUD BAYS</b>					
689WG3202	(1) 525-1622, (2) 630WG248	BI	12	12	\$29.24
<b>24" STUD BAYS</b>					
689WG3212	(1) 525-2422, (2) 630WG248	BI	12	12	\$29.98

## F1960 Stub Out Kit

### 3/4" Water Heater Stub Outs With Bracket

- Manage materials more easily
- Save labor costs
- Prevent leaks by using preformed copper
- All copper components are made from Type L copper tube
- For individual product details, see product pages
- NL/DZR



689WG5103

Item Number	Item Description	Pkg Type	Min Qty	Case Qty	Price
689WG5103	(1) 525-1623, (2) 630WG348	BI	12	12	\$59.93

## F1960 Stub Out Kit

### 1/2" Shower Riser Elbow With Bracket

- Manage materials more easily
- Save labor costs
- Prevent leaks by using preformed copper
- All copper components are made from Type L copper tube
- For individual product details, see product pages
- NL/DZR



689WG2291

#### Related Products

Shower WallNut™ p 640

Item Number	Item Description	Pkg Type	Min Qty	Case Qty	Price
689WG2291	(1) 525-16WLB, (1) 630WG248	BI	12	12	\$18.14

## F1960 Water Heater Connector Kit

- DO NOT use pipe dope on FIP swivel threads
- Pre-manufactured assemblies
- Maintains the necessary 18" distance from PEX
- For individual product details, see product pages
- NL/DZR



694WG71022091

Item Number	Item Description	Pkg Type	Min Qty	Case Qty	Price
694WG71022091	(1)631WG02FP, (1)633-G3TM15, (1)633WG18	BI	10	10	\$123.84



**1/2" F1960 Branch, Manifold**  
**3/4" F1960 x Spun Closed Trunk**

- Do not recirculate back through any manifold branch. Do not modify manifold. Doing so will void warranty
- 1" Type L copper trunk
- Branches are 1-1/2" on-center
- NL/DZR

Item Number	Item Description	Pkg Type	Min Qty	Case Qty	Price
672WG0490	1/2" F1960, 4 Port	BI	10	10	\$65.24
672WG0690	1/2" F1960, 6 Port	BI	10	10	\$90.87
672WG0890	1/2" F1960, 8 Port	BI	10	10	\$116.49



**1/2" F1960 Branch, Manifold**  
**3/4" F1960 x 3/4" F1960 Trunk**

- Do not recirculate back through any manifold branch. Do not modify manifold. Doing so will void warranty
- 1" Type L copper trunk
- Branches are 1-1/2" on-center
- NL/DZR

Item Number	Item Description	Pkg Type	Min Qty	Case Qty	Price
672WG0499	1/2" F1960, 4 Port	BI	10	10	\$70.09
672WG0699	1/2" F1960, 6 Port	BI	10	10	\$95.72
672WG0899	1/2" F1960, 8 Port	BI	10	10	\$121.34

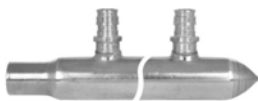

**1/2" F1960 Branch, Manifold**  
**3/4" MSWT x Spun Closed Trunk**

- Do not recirculate back through any manifold branch. Do not modify manifold. Doing so will void warranty
- 1" Type L copper trunk
- Non-valved branches are 1-1/2" on-center. Valved branches are 2" on-center
- NL/DZR
- 3/4" male sweat inlet/outlet can be soldered, pressed or push fit onto

Item Number	Item Description	Pkg Type	Min Qty	Case Qty	Price
<b>STANDARD</b>					
672WG0430	1/2 F1960, 4 Port	BI	1	10	\$64.92
672WG0630	1/2 F1960, 6 Port	BI	1	10	\$90.87
672WG0830	1/2 F1960, 8 Port	BI	1	10	\$116.49

## 1/2" F1960 Branch, Manifold (Cont)

### 3/4" MSWT x Spun Closed Trunk

Item Number	Item Description	Pkg Type	Min Qty	Case Qty	Price
<b>BALL VALVE BRANCHES</b>					
672WV0230	1/2" F1960, 2 Port	BI	1	10	\$65.36
672WV0330	1/2" F1960, 3 Port	BI	1	10	\$91.26
672WV0430	1/2" F1960, 4 Port	BI	1	10	\$117.16
672WV0630	1/2" F1960, 6 Port	BI	1	10	\$168.96
672WV0830	1/2" F1960, 8 Port	BI	1	10	\$220.76
672WV1030	1/2" F1960, 10 Port	BI	1	10	\$272.56
672WV1230	1/2" F1960, 12 Port	BI	1	4	\$324.36

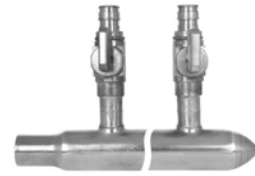

## 1/2" F1960 Branch, Manifold

### 1" MSWT x Spun Closed Trunk

- Do not recirculate back through any manifold branch. Do not modify manifold. Doing so will void warranty
- 1" Type L copper trunk
- Branches are 1-1/2" on-center
- NL/DZR
- 1" male sweat inlet/outlet can be soldered, pressed or push fit onto

Item Number	Item Description	Pkg Type	Min Qty	Case Qty	Price
672WG0240	1/2" F1960, 2 Port	BI	1	10	\$33.98
672WG0340	1/2" F1960, 3 Port	BI	1	10	\$46.79
672WG0440	1/2" F1960, 4 Port	BI	1	10	\$59.61
672WG0640	1/2" F1960, 6 Port	BI	1	10	\$85.23
672WG0840	1/2" F1960, 8 Port	BI	1	10	\$110.86
672WG1040	1/2" F1960, 10 Port	BI	1	10	\$136.48
672WG1240	1/2" F1960, 12 Port	BI	1	10	\$162.11

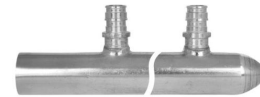

Supply

Drainage

Support

Specialties

Appendix



### 1/2" F1960 Branch, Manifold

#### 1" CPVC x Spun Closed Trunk

- Do not recirculate back through any manifold branch. Do not modify manifold. Doing so will void warranty
- 1" Type L copper trunk
- Branches are 1-1/2" on-center
- NL/DZR

Item Number	Item Description	Pkg Type	Min Qty	Case Qty	Price
672WG03CO	1/2" F1960, 3 Port	BI	10	10	\$58.45
672WG04CO	1/2" F1960, 4 Port	BI	10	10	\$71.27
672WG06CO	1/2" F1960, 6 Port	BI	10	10	\$96.90
672WG08CO	1/2" F1960, 8 Port	BI	10	10	\$122.52



### 1/2" F1960 Valved Branch, Manifold

#### 1" MSWT x 1" MSWT Trunk

- Do not recirculate back through any manifold branch. Do not modify manifold. Doing so will void warranty
- 1" Type L copper trunk
- Branches are 2" on-center
- NL/DZR
- 1" male sweat inlet/outlet can be soldered, pressed or push fit onto

Item Number	Item Description	Pkg Type	Min Qty	Case Qty	Price
672WV0444	1/2" F1960, 4 Port	BI	1	10	\$110.73
672WV0644	1/2" F1960, 6 Port	BI	1	10	\$162.53
672WV0844	1/2" F1960, 8 Port	BI	1	10	\$197.93
672WV1044	1/2" F1960 10 Port	BI	1	10	\$266.13



672WGT0390

### 1/2" F1960 Branch, Multi-Port Tee

#### 3/4" F1960 PEX x Closed Trunk

- One-piece, No Lead brass material
- DZR, SCC resistant

Item Number	Item Description	Pkg Type	Min Qty	Case Qty	Price
<b>NL/DZR BRASS</b>					
672WGT0390	1/2" F1960, 3 Port, 1/Bag	BI	10	100	\$31.98
672WGT0490	1/2" F1960, 4 Port, 1/Bag	BI	10	100	\$40.38



## 1/2" F1960 Branch, Multi-Port Tee

### 3/4" F1960 PEX x 3/4" F1960 PEX Trunk

- One-piece, No Lead brass material
- DZR, SCC resistant



672WGT0499

Item Number	Item Description	Pkg Type	Min Qty	Case Qty	Price
<b>NL/DZR BRASS</b>					
672WGT0399	1/2" F1960, 3 Port, 1/Bag	BI	10	100	\$32.86
672WGT0499	1/2" F1960, 4 Port, 1/Bag	BI	10	100	\$41.26

Supply

Drainage

Support

Specialties

Appendix



649W2

### F1960 Expansion Ring

· For use with PEX SDR9 tube only

#### Related Products

F1960 Expansion Tools p 78

Item Number	Item Description	Pkg Type	Min Qty	Case Qty	Price
649W2	1/2" F1960	B	50	1000	\$0.29
649W3	3/4" F1960	B	50	500	\$0.51
649W4	1" F1960	B	25	250	\$0.92
649WP2	1/2" F1960, PEX-A	B	50	1000	\$0.57
649WP3	3/4" F1960, PEX-A	B	50	500	\$1.02
649WP4	1" F1960, PEX-A	B	25	250	\$1.84
649WP5	1-1/4" F1960, PEX-A	B	10	10	\$2.17
649WP6	1-1/2" F1960, PEX-A	B	10	10	\$2.23
649WP7	2" F1960, PEX-A	B	10	10	\$4.06



642WP3

### F1960 Poly Elbow

Item Number	Item Description	Pkg Type	Min Qty	Case Qty	Price
642WP2	1/2" x 1/2"	B	25	625	\$2.48
642WP3	3/4" x 3/4"	B	25	375	\$3.17
642WP4	1" x 1"	B	10	160	\$6.46
642WP5	1-1/4" X 1-1/4"	BI	1	5	\$12.88
<b>642WP6</b>	<b>1-1/2" X 1-1/2"</b>	BI	1	5	<b>\$19.60</b>
642WP7	2" X 2"	BI	1	5	\$58.79



641WP222

### F1960 Poly Tee

· Full flow fitting - no restriction

Item Number	Item Description	Pkg Type	Min Qty	Case Qty	Price
<b>STANDARD TEE</b>					
641WP222	1/2" x 1/2" x 1/2"	B	25	500	\$2.48
641WP333	3/4" x 3/4" x 3/4"	B	25	200	\$4.13
641WP444	1" x 1" x 1"	B	10	100	\$7.44
641WP555	1-1/4" x 1-1/4" x 1-1/4"	BI	1	5	\$17.92
641WP666	1-1/2" x 1-1/2" x 1-1/2"	BI	1	5	\$36.69
641WP777	2" x 2" x 2"	BI	1	5	\$85.84
<b>REDUCING TEE</b>					
641WP322	3/4" x 1/2" x 1/2"	B	25	300	\$3.88
641WP323	3/4" x 1/2" x 3/4"	B	25	250	\$3.88
641WP332	3/4" x 3/4" x 1/2"	B	25	250	\$3.28
641WP433	1" x 3/4" x 3/4"	B	10	140	\$7.20
641WP434	1" x 3/4" x 1"	B	10	120	\$7.09
641WP442	1" x 1" x 1/2"	B	10	150	\$6.98
641WP443	1" x 1" x 3/4"	B	10	120	\$7.55
<b>641WP535</b>	<b>1-1/4" x 3/4" x 1-1/4"</b>	BI	1	5	<b>\$13.39</b>

**F1960 Poly Tee (Cont)**

Item Number	Item Description	Pkg Type	Min Qty	Case Qty	Price
<b>REDUCING TEE</b>					
641WP545	1-1/4" x 1" x 1-1/4"	Bl	1	5	\$17.56
641WP552	1-1/4" x 1-1/4" x 1/2"	Bl	1	5	\$15.54
641WP553	1-1/4" x 1-1/4" x 3/4"	Bl	1	5	\$17.16
641WP554	1-1/4" x 1-1/4" x 1"	Bl	1	5	\$17.29
641WP636	1-1/2" x 3/4" x 1-1/2"	Bl	1	5	\$18.47
641WP646	1-1/2" x 1" x 1-1/2"	Bl	1	5	\$18.43
641WP655	1-1/2" x 1-1/4" x 1-1/4"	Bl	1	5	\$25.91
641WP656	1-1/2" x 1-1/4" x 1-1/2"	Bl	1	5	\$26.10
641WP663	1-1/2" x 1-1/2" x 3/4"	Bl	1	5	\$20.85
641WP664	1-1/2" x 1-1/2" x 1"	Bl	1	5	\$21.71
641WP665	1-1/2" x 1-1/2" x 1-1/4"	Bl	1	5	\$25.91
641WP747	2" x 1" x 2"	Bl	1	5	\$63.56
641WP757	2" x 1-1/4" x 2"	Bl	1	5	\$63.21
641WP774	2" x 2" x 1"	Bl	1	5	\$77.17
641WP775	2" x 2" x 1-1/4"	Bl	1	5	\$80.71
641WP776	2" x 2" x 1-1/2"	Bl	1	5	\$82.21
<b>BULLHEAD TEE</b>					
641WP223	1/2" x 1/2" x 3/4"	B	25	300	\$3.88
641WP334	3/4" x 3/4" x 1"	B	10	140	\$7.36



641WP332



641WP223

**F1960 Poly Coupling**

· Full flow fitting - no restriction

Item Number	Item Description	Pkg Type	Min Qty	Case Qty	Price
645WP2	1/2" x 1/2"	B	25	1000	\$1.99
645WP3	3/4" x 3/4"	B	25	500	\$2.55
645WP32	3/4" x 1/2"	B	25	500	\$4.32
645WP4	1" x 1"	B	10	200	\$4.13
645WP42	1" x 1/2"	B	25	250	\$5.95
645WP43	1" x 3/4"	B	25	250	\$6.19
645WP5	1-1/4" X 1-1/4"	Bl	1	5	\$10.34
645WP53	1-1/4" X 3/4"	Bl	1	5	\$9.65
<b>645WP54</b>	1-1/4" x 1"	Bl	1	5	\$10.44
645WP6	1-1/2" X 1-1/2"	Bl	1	5	\$18.00
645WP65	1-1/2" X 1-1/4"	Bl	1	5	\$15.31
645WP7	2" X 2"	Bl	1	5	\$37.57
645WP76	2" X 1-1/2"	Bl	1	5	\$31.70



645WP2



645WP32

Supply

Drainage

Support

Specialties

Appendix

Supply

Drainage

Support

Specialties

Appendix



640WP02

### F1960 Poly Plug

· For temporary or permanent installation

Item Number	Item Description	Pkg Type	Min Qty	Case Qty	Price
640WP02	1/2" F1960	B	25	1000	\$1.58
640WP03	3/4" F1960	B	25	750	\$2.49
640WP04	1" F1960	B	10	360	\$3.21
640WP5	1-1/4" F1960	BI	1	5	\$10.08
640WP6	1-1/2" F1960	BI	1	5	\$20.72
640WP7	2" F1960	BI	1	5	\$35.73



646WP3

### F1960 Poly Straight Adapter

MIP

Item Number	Item Description	Pkg Type	Min Qty	Case Qty	Price
646WP2	1/2" F1960 × 1/2" MIP	B	25	800	\$3.16
646WP3	3/4" F1960 × 3/4" MIP	B	25	500	\$3.39
646WP32	1/2" F1960 × 3/4" MIP	B	10	400	\$3.71
646WP4	1" F1960 × 1" MIP	B	10	200	\$6.67



632WP222M

### F1960 Poly Elbow Adapter

MIP

· Full flow fitting - no restriction

Item Number	Item Description	Pkg Type	Min Qty	Case Qty	Price
632WP222M	1/2" F1960 × 1/2" MIP	B	25	375	\$4.37



637WP20

### F1960 Poly Faucet Adapter

Item Number	Item Description	Pkg Type	Min Qty	Case Qty	Price
<b>1/2" FIP SWIVEL - STRAIGHT</b>					
637WP20	1/2" F1960	B	25	500	\$4.37
<b>1/2" FIP SWIVEL - ELBOW</b>					
637WP25	1/2" F1960	B	25	375	\$5.40



637WP25

**1/2" F1960 Branch, Poly Manifold**

**3/4" F1960 x Closed Trunk**

Item Number	Item Description	Pkg Type	Min Qty	Case Qty	Price
672WP0390	1/2" F1960, 3 Port	BI	10	140	\$13.99
672WP0490	1/2" F1960, 4 Port	BI	10	100	\$17.24
672WP0690	1/2" F1960, 6 Port	BI	10	60	\$23.95



672WP0390

**1/2" F1960 Branch, Poly Manifold**

**3/4" F1960 x 3/4" F1960 Trunk**

Item Number	Item Description	Pkg Type	Min Qty	Case Qty	Price
672WP0299	1/2" F1960, 2 Port	BI	10	140	\$10.72
672WP0399	1/2" F1960, 3 Port	BI	10	140	\$14.09
672WP0499	1/2" F1960, 4 Port	BI	10	100	\$17.45
672WP0699	1/2" F1960, 6 Port	BI	10	60	\$24.16



672WP0699

**1/2" F1960 Branch, Poly Manifold**

**1" F1960 x Closed Trunk**

Item Number	Item Description	Pkg Type	Min Qty	Case Qty	Price
672WP0670	1/2" F1960, 6 Port	BI	10	60	\$24.37



672WP0670

**1/2" F1960 Branch, Poly Manifold**

**1" F1960 x 1" F1960 Trunk**

Item Number	Item Description	Pkg Type	Min Qty	Case Qty	Price
672WP0677	1/2" F1960, 6 Port	BI	10	60	\$25.10



672WP0677

**1/2" F1960 Branch, Poly Multi-Port Tee**

**3/4" F1960 x 3/4" F1960 Trunk**

Item Number	Item Description	Pkg Type	Min Qty	Case Qty	Price
672WPT0399	1/2" F1960, 3 Port	BI	10	10	\$20.87
672WPT0499	1/2" F1960, 4 Port	BI	10	10	\$26.51
672WPT0699	1/2" F1960, 6 Port	BI	10	10	\$37.54



672WPT0699



305-W2H

## F1960 Tools

· To insure a proper joint, Sioux Chief suggests the use of a power rotating tool

Item Number	Item Description	Pkg Type	Min Qty	Case Qty	Price
<b>EXPANSION TOOL</b>					
305-W23KIT	F1960 Standard Tool Kit w/ 1/2" & 3/4" Heads	BI	1	5	\$457.49
305-WT	F1960 Pipe Expander Tool Only	BI	1	10	\$254.32
<b>EXPANDER HEADS</b>					
305-W2H	1/2"	BI	1	20	\$97.84
305-W3H	3/4"	BI	1	20	\$97.84
305-W4H	1"	BI	1	20	\$97.84

# PowerPEX<sup>®</sup> Systems for ASTM F3347

**ASTM F3347 - Fittings & Valves**

**ASTM F3347 - Kits**

All Sioux Chief PowerPEX<sup>®</sup> ASTM F3347 PEX fittings are manufactured to the ASTM F3347 standard.

**Note:** A properly calibrated, press sleeve tool **MUST** be used to connect PEX tubing to an ASTM F3347 PEX fitting. Be sure tubing is cut squarely, tube is inserted into sleeve completely and fitting is inserted fully into tube.

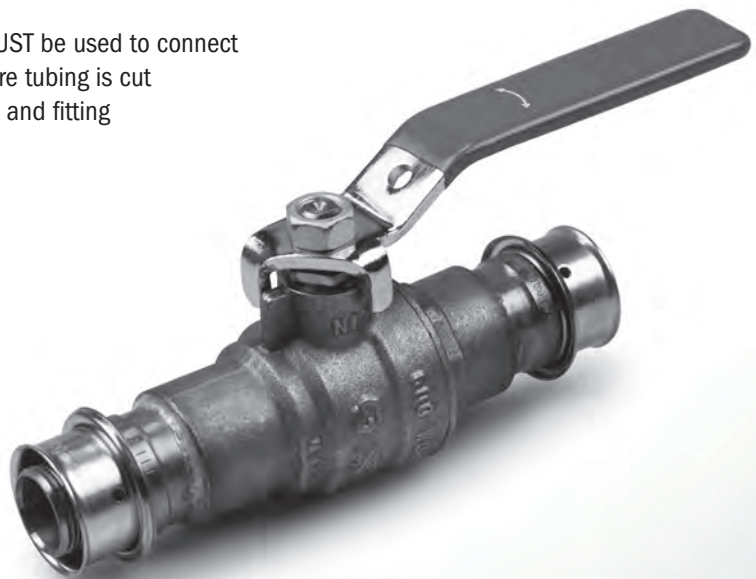



**645VGC4**  
Page 81



**630VG248**  
Page 81



**630VG248E**  
Page 81



**638VG208E4**  
Page 81



**632VG273**  
Page 81



**633VG18**  
Page 82







**633VG18FP**  
Page 82



**648VG3FP**  
Page 82



**689VG3202**  
Page 83

 <b>633VG18</b> Page 82	 <b>633VG18FP</b> Page 82	 <b>648VG3FP</b> Page 82	 <b>689VG3202</b> Page 83	



### F3347 Straight Adapter

#### CPVC, CTS

Item Number	Item Description	Pkg Type	Min Qty	Case Qty	Price
<b>NL/DZR CPVC CUP</b>					
645VGC2	1/2" F3347 PEX Press × 1/2" CPVC	B	50	50	\$11.92
645VGC3	3/4" F3347 PEX Press × 3/4" CPVC	B	50	50	\$21.92
645VGC4	1" F3347 PEX Press × 1" CPVC	B	20	20	\$36.10



645VGC4

### F3347 Stub Out Elbow

· NL/DZR

Item Number	Item Description	Pkg Type	Min Qty	Case Qty	Price
630VG248	1/2" F3347 PEX Press, 3-1/2" × 8"	B	25	25	\$13.67



630VG248

### F3347 Stub Out Elbow

#### Square O Strap

· NL/DZR

Item Number	Item Description	Pkg Type	Min Qty	Case Qty	Price
630VG248E	1/2" F3347 PEX Press, 3-1/2" × 8", w/ Strap	B	25	25	\$14.74

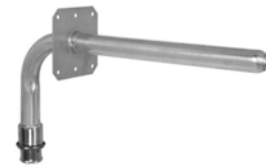

630VG248E

### F3347 Bullet™

#### Spun Closed w/ Square O Strap

· Not to be used as permanent air chambers  
· NL/DZR

Item Number	Item Description	Pkg Type	Min Qty	Case Qty	Price
638VG208E4	1/2" F3347 PEX Press, 8" Long, 4" Stub Out	B	25	25	\$15.60
638VG218E4	1/2" F3347 PEX Press, 18" Long, 14" Stub Out	B	25	25	\$20.87



638VG208E4

### F3347 Tub/Shower Pressure Connector

· NL/DZR

Item Number	Item Description	Pkg Type	Min Qty	Case Qty	Price
632VG273	1/2" F3347 PEX Press × 1/2" MSWT, 7" × 3"	B	50	50	\$12.42



632VG273

Supply

Drainage

Support

Specialties

Appendix



633VG18



633VG18FP



648VG3FP

## F3347 Water Heater Connector

### FIP Swivel Straight

- DO NOT use pipe dope on FIP swivel threads
- NL/DZR

Item Number	Item Description	Pkg Type	Min Qty	Case Qty	Price
<b>STANDARD</b>					
633VG18	3/4" F3347 PEX Press × 3/4" MIP	BI	10	10	\$35.75
<b>VALVED, FULL PORT</b>					
633VG18FP	3/4" F3347 PEX Press × 3/4" FIP Swivel, Full Port	B	10	10	\$70.75

## F3347 Brass Ball Valve

- NL/DZR Brass

Item Number	Item Description	Pkg Type	Min Qty	Case Qty	Price
<b>FULL PORT</b>					
648VG2FP	1/2" F3347 PEX Press	B	10	10	\$45.42
648VG3FP	3/4" F3347 PEX Press	B	10	10	\$69.49
648VG4FP	1" F3347 PEX Press	B	10	10	\$115.56

### F3347 Stub Out Kit

#### 1/2" Water Closet Stub Out With Bracket

- For individual product details, see product pages
- NL/DZR

Item Number	Item Description	Pkg Type	Min Qty	Case Qty	Price
<b>16" STUD BAY</b>					
689VG2201	(1) 525-1612, (1) 630VG248	BI	12	12	\$19.13
<b>24" STUD BAY</b>					
689VG2211	(1) 525-2412, (1) 630VG248	BI	12	12	\$19.88

### F3347 Stub Out Kit

#### 1/2" Lav/Sink Stub Outs With Bracket

- For individual product details, see product pages
- NL/DZR

Item Number	Item Description	Pkg Type	Min Qty	Case Qty	Price
<b>16" STUD BAY</b>					
689VG3202	(1) 525-1622, (2) 630VG248	BI	12	12	\$34.14
<b>24" STUD BAY</b>					
689VG3212	(1) 525-2422, (2) 630VG248	BI	12	12	\$34.88



689VG2201



689VG2211



689VG3202



689VG3212

Supply

Drainage

Support

Specialties

Appendix



# **Specialized Supply**

**for CPVC Systems**

**for PVC Systems**

**for Sweat/Copper**

**PDQ™ Push Fit  
Systems**

**Supply  
Accessories**

# Specialized Supply

## CPVC Systems

Sioux Chief CPVC fittings conform to *ASTM D2846 Standard Specification for Chlorinated Polyvinyl Chloride (CPVC) Plastic Hot and Cold Water Distribution Systems* and are designed for use with CTS (copper tube size) CPVC pipe and fittings conforming to ASTM D2846.

Sioux Chief also offers CPVC fittings for the ASTM F438 system that are designed for use with IPS (iron pipe size) CPVC pipe and fittings which conform to ASTM F438

A select group of our transition fittings have been tested and certified by CSA to the ASTM D2846 Standard and CSA Standard B137.6 and/or IAPMO listed.

## PVC Systems

Sioux Chief PVC fittings conform to the *ASTM F1970 Standard Specification for Special Engineered Fittings, Appurtenances or Valves for use in Polyvinyl Chloride (PVC) or Chlorinated Polyvinyl Chloride (CPVC) Systems* and are designed for use with Sch. 40 PVC pipe conforming to ASTM D1785.

## Sweat/Copper Systems

Sioux Chief Rough-in Ready™ preformed copper fittings for sweat are made in the USA from 100% pure copper tube that conforms to the following specifications:

Tube: ASTM B88 and Fitting Ends: ANSI B16.22

## PDQ™ Push Fit System

Sioux Chief PDQ™ push-fittings are made to the *ASSE 1061 Performance Requirements for Push-Fit Fittings*.

PDQ™ fittings are removable, can be rotated after installation, and are approved for underground and sealed wall applications.

All PDQ™ fittings are tested to ASSE 1061/NSF 61 standards and are IAPMO listed to cUPC.

## Supply Accessories

Sioux Chief's closed-cell foam insulation is made in the USA and provides the ideal combination of flexibility and rigidity for easier installation.

# CTS CPVC Systems

## CPVC Fittings, Adapters & Connectors

## CPVC Preformed Copper & Valves

Sioux Chief offers the most complete line of CPVC transition fittings in the industry. Our fittings are compatible with FlowGuard Gold® pipe/fittings and are FGG/BM/CZ™ System compatible. All fittings are 100% production tested to ensure maximum quality and a leak-free connection.

**Important Notes About Sioux Chief CPVC Fittings:**

Do not cut, or modify any Sioux Chief CPVC transition fitting (except 630-C series fittings).

Do not expose CPVC transition area of fitting to heat in excess of 180°F.

Never install a damaged fitting.

FlowGuard Gold® and FGG/BM/CZ™ are trademarks of Lubrizol Advanced Materials, Inc.



See complete installation instructions at [www.siouxchief.com](http://www.siouxchief.com)



**645XC3**  
Page 89



**645WGC2**  
Page 89



**645VGC3**  
Page 89



**643-C311**  
Page 90



**646-CG2**  
Page 90



**647-CG6**  
Page 90



**685-C4**  
Page 91



**647-C2DW**  
Page 91



**633-C02**  
Page 91



**647-CG2E3**  
Page 92



**615-C215**  
Page 92



**630-C248**  
Page 93



**632-C263X**  
Page 93



**631-CG307FP**  
Page 94



**633-CG24FP**  
Page 94



**634-C118**  
Page 95



**648-CG2FP**  
Page 96



**118-C208**  
Page 96



**689C1102**  
Page 97



**645XC93**  
Page 101



**643-C9418**  
Page 101



**646-CG96**  
Page 101



**645WG3P**  
Page 105



**647-PG5**  
Page 106



**648-PG3FP**  
Page 107



**CPVC Straight Adapter**

**F1807**

Item Number	Item Description	Pkg Type	Min Qty	Case Qty	Price
<b>COPPER CPVC CUP</b>					
645XC2	1/2" F1807 × 1/2" CPVC	B	50	50	\$5.84
645XC23	1/2" F1807 × 3/4" CPVC	B	50	50	\$10.06
645XC2PK2	1/2" F1807 × 1/2" CPVC, 1/Bag	Cl	10	10	\$5.99
645XC3	3/4" F1807 × 3/4" CPVC	B	50	50	\$6.47
645XC34	3/4" F1807 × 1" CPVC	B	20	20	\$17.82
645XC3PK2	3/4" F1807 × 3/4" CPVC, 1/Bag	Cl	10	10	\$6.62
645XC4	1" F1807 × 1" CPVC	B	20	20	\$17.52
645XC43	1" F1807 × 3/4" CPVC	B	20	20	\$17.82
<b>COPPER CPVC MALE</b>					
645XCM2	1/2" F1807 × 1/2" Male CPVC	B	50	50	\$8.62



645XC3



645XCM2

**CPVC Straight Adapter**

**F1960**

Item Number	Item Description	Pkg Type	Min Qty	Case Qty	Price
<b>OVERMOLD NL/DZR BRASS CPVC CUP</b>					
645WGC2	1/2" F1960 × 1/2" CPVC	B	50	50	\$10.49
645WGC3	3/4" F1960 × 3/4" CPVC	B	50	50	\$17.93
645WGC4	1" F1960 × 1" CPVC	B	20	20	\$25.87
<b>ASSEMBLED NL/DZR COPPER/BRASS</b>					
645WGC5	1-1/4" F1960 × 1-1/4" CPVC - Assembly	B	5	5	\$70.70
645WGC6	1-1/2" F1960 × 1-1/2" CPVC - Assembly	B	5	5	\$91.40
645WGC7	2" F1960 × 2" CPVC - Assembly	B	5	5	\$148.08



645WGC2



645WGC5

**CPVC Straight Adapter**

**F3347**

Item Number	Item Description	Pkg Type	Min Qty	Case Qty	Price
<b>NL/DZR CPVC CUP</b>					
645VGC2	1/2" F3347 PEX Press × 1/2" CPVC	B	50	50	\$11.92
645VGC3	3/4" F3347 PEX Press × 3/4" CPVC	B	50	50	\$21.92
645VGC4	1" F3347 PEX Press × 1" CPVC	B	20	20	\$36.10



645VGC3

Supply

Drainage

Support

Specialties

Appendix



643-C418

## CPVC Straight Adapter

### Male Sweat

- DO NOT cut this fitting. Cutting this fitting voids warranty
- Do not allow CPVC portion of fitting to be heated.
- Plain copper end is press-fitting compatible

Item Number	Item Description	Pkg Type	Min Qty	Case Qty	Price
<b>COPPER CPVC CUP</b>					
643-C211	1/2" CPVC × 1/2" MSWT, 11"	B	100	100	\$9.15
643-C311	3/4" CPVC × 3/4" MSWT, 11"	B	50	50	\$17.45
643-C418	1" CPVC × 1" MSWT, 18"	B	25	25	\$38.34
643-C518	1-1/4" CPVC × 1-1/4" MSWT, 18"	B	10	10	\$53.70
643-C620	1-1/2" CPVC × 1-1/2" MSWT, 20"	B	1	10	\$60.66
643-C722	2" CPVC × 2" MSWT, 22"	B	1	10	\$126.94



646-CG2



646-CG5

## CPVC Straight Adapter

### MIP

Item Number	Item Description	Pkg Type	Min Qty	Case Qty	Price
<b>OVERMOLD NL/DZR BRASS CPVC CUP</b>					
646-CG2	1/2" CPVC × 1/2" MIP	B	50	50	\$7.28
646-CG2PK1	1/2" CPVC × 1/2" MIP	BI	25	25	\$7.53
646-CG3	3/4" CPVC × 3/4" MIP	B	50	50	\$9.45
646-CG4	1" CPVC × 1" MIP	B	20	20	\$19.54
<b>NL/DZR BRASS CPVC CUP</b>					
646-CG5	1-1/4" CPVC × 1-1/4" MIP	B	10	10	\$50.74
646-CG6	1-1/2" CPVC × 1-1/2" MIP	B	10	10	\$63.88
646-CG7	2" CPVC × 2" MIP	B	10	10	\$96.89



647-CG2



647-CG6

## CPVC Straight Adapter

### FIP

Item Number	Item Description	Pkg Type	Min Qty	Case Qty	Price
<b>OVERMOLD NL/DZR BRASS CPVC CUP</b>					
647-CG2	1/2" CPVC × 1/2" FIP	B	50	50	\$7.28
647-CG2PK1	1/2" CPVC × 1/2" FIP	CI	25	25	\$7.53
647-CG3	3/4" CPVC × 3/4" FIP	B	50	50	\$11.33
647-CG3PK1	3/4" CPVC × 3/4" FIP	CI	25	25	\$11.58
647-CG4	1" CPVC × 1" FIP	B	20	20	\$24.42
<b>NL/DZR BRASS CPVC CUP</b>					
647-CG5	1-1/4" CPVC × 1-1/4" FIP	B	10	10	\$52.09
647-CG6	1-1/2" CPVC × 1-1/2" FIP	B	10	10	\$65.58
647-CG7	2" CPVC × 2" FIP	B	10	10	\$99.50

## CPVC Straight Adapter

### Press-Fitting

- Mechanical connection only
- Applying heat or cutting this fitting voids warranty.
- Plain copper end is press-fitting compatible



685-C3

Item Number	Item Description	Pkg Type	Min Qty	Case Qty	Price
<b>COPPER CPVC CUP</b>					
685-C2	1/2" CPVC × 1/2" Press-Fitting	B	20	20	\$7.13
685-C3	3/4" CPVC × 3/4" Press-Fitting	B	20	20	\$9.38
685-C4	1" CPVC × 1" Press-Fitting	B	20	20	\$13.55
685-C5	1-1/4" CPVC × 1-1/4" Press-Fitting	B	10	10	\$23.17
685-C6	1-1/2" CPVC × 1-1/2" Press-Fitting	B	5	5	\$33.11
685-C7	2" CPVC × 2" Press-Fitting	B	5	5	\$45.38

## CPVC Straight Adapter

### Sillcock Adapter

Item Number	Item Description	Pkg Type	Min Qty	Case Qty	Price
<b>LEADED</b>					
647-C2D	1/2" CPVC × 1/2" FIP Drop-Ear	B	50	50	\$21.31
647-C2DW	1/2" CPVC × 1/2" FIP Wing-Ear	B	50	50	\$20.31



647-C2D



647-C2DW

## CPVC Short-N-Swivel™ Straight Adapter

### FIP Swivel

- DO NOT use pipe dope on FIP swivel threads



637-C20

Item Number	Item Description	Pkg Type	Min Qty	Case Qty	Price
<b>NL/DZR CPVC CUP</b>					
633-C02	3/4" CPVC × 3/4" FIP Swivel	B	50	50	\$12.44
633-C02PK	3/4" CPVC × 3/4" FIP Swivel	Cl	10	10	\$12.94
633-C4403	1" CPVC × 1" FIP Swivel	B	20	20	\$24.98
637-C20	1/2" CPVC × 1/2" FIP Swivel	B	25	25	\$9.99
637-C20PK2	1/2" CPVC × 1/2" FIP Swivel	Cl	10	10	\$10.14

Supply

Drainage

Support

Specialties

Appendix



616-CG2E3



647-CG2E3



615-C215

## CPVC Elbow Adapter

### Tub/Shower Elbow

**Related Products**

WiderSlider™ Adjustable Bracket p 529

Shower Arm Test Plug p 467

Item Number	Item Description	Pkg Type	Min Qty	Case Qty	Price
<b>DROP EAR - CPVC - NL/DZR</b>					
616-CG2E3	1/2" CPVC × 1/2" FIP	B	50	50	\$8.41
<b>DROP EAR - NL/DZR BRASS</b>					
647-CG2E3	1/2" CPVC × 1/2" FIP	B	50	50	\$12.99
647-CG2E3PK1	1/2" CPVC × 1/2" FIP, 1/Bag	CI	10	10	\$13.24
<b>EARED ELBOW - LEADED</b>					
647-C3E	3/4" CPVC × 3/4" FIP	B	25	25	\$22.21
647-C4E	1" CPVC × 1" FIP	B	10	10	\$35.72

## Wal-Let™ - CPVC

### Wall Termination Fitting

Item Number	Item Description	Pkg Type	Min Qty	Case Qty	Price
<b>LEADED</b>					
615-C2113	1/2" FIP × 1/2" CPVC, 11" Straight	B	25	25	\$31.90
615-C215	1/2" FIP × 1/2" CPVC, 1-5/8" Straight	B	10	10	\$23.01

**CPVC Stub Out Elbow**

**Standard**

- Do not allow CPVC portion of fitting to be heated.

Item Number	Item Description	Pkg Type	Min Qty	Case Qty	Price
630-C2412	1/2" CPVC, 4" x 12"	B	50	50	\$12.27
630-C248	1/2" CPVC, 4" x 8"	B	50	50	\$8.26
630-C248PK	1/2" CPVC, 4" x 8"	Cl	10	10	\$8.76
630-C287	1/2" CPVC, 8" x 7"	B	50	50	\$12.27
630-C348	3/4" CPVC, 6" x 8"	B	50	50	\$17.75
630-C3612	3/4" CPVC, 6" x 12"	B	25	25	\$27.60
630-C41016	1" CPVC, 10" x 16"	B	25	25	\$50.25
630-C41110	1" CPVC, 11" x 10"	B	25	25	\$42.76



630-C248

**CPVC Stub Out Elbow**

**Square O Strap**

- Do not allow CPVC portion of fitting to be heated.

Item Number	Item Description	Pkg Type	Min Qty	Case Qty	Price
630-C248E	1/2" CPVC, 4" x 8", w/Strap	B	25	25	\$9.26
630-C41110E	1" CPVC, 11" x 10", w/ Strap	B	10	10	\$44.10

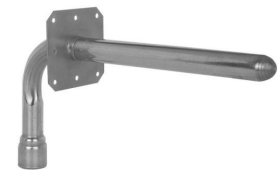

630-C248E

**CPVC Tub/Shower Pressure Connector**

- DO NOT use pipe dope on FIP swivel threads
- Do not allow CPVC portion of fitting to be heated
- NL/DZR

Item Number	Item Description	Pkg Type	Min Qty	Case Qty	Price
632-C263	1/2" CPVC x 1/2" MSWT, 6" x 2-1/4"	B	50	50	\$6.36
632-C263PK	1/2" CPVC x 1/2" MSWT, 6" x 2-1/4"	Cl	10	10	\$6.86
632-C263X	1/2" CPVC x 1/2" MIP Swivel, 6" x 3"	B	50	50	\$13.12
632-C263XPK	1/2" CPVC x 1/2" MIP Swivel, 6" x 3"	Cl	10	10	\$13.62
632-C263YPK	1/2" CPVC x 1/2" FIP Swivel, 6" x 3"	Cl	10	10	\$13.11
632-C283	1/2" CPVC x 1/2" MSWT, 8" x 3"	B	50	50	\$7.38



632-C263X

Supply

Drainage

Support

Specialties

Appendix

Supply

Drainage

Support

Specialties

Appendix



631-C307



631-CG307FP



633-C09



633-CG24FP



633-CG18HRV

## CPVC Water Heater Connector

### FIP Swivel Elbow

- DO NOT use pipe dope on FIP swivel threads
- NL/DZR

Item Number	Item Description	Pkg Type	Min Qty	Case Qty	Price
<b>STANDARD</b>					
631-C307	3/4" CPVC × 3/4" FIP Swivel, 7" × 3"	B	25	25	\$23.10
<b>VALVED, FULL PORT</b>					
631-CG307FP	3/4" CPVC × 3/4" FIP Swivel, 7" × 3"	B	10	10	\$56.18

## CPVC Water Heater Connector

### FIP Swivel Straight

- DO NOT use pipe dope on FIP swivel threads
- NL/DZR

Item Number	Item Description	Pkg Type	Min Qty	Case Qty	Price
<b>STANDARD</b>					
633-C02	3/4" CPVC × 3/4" FIP Swivel	B	50	50	\$12.44
633-C02PK	3/4" CPVC × 3/4" FIP Swivel	CI	10	10	\$12.94
633-C09	3/4" CPVC × 3/4" FIP Swivel, 9"	B	25	25	\$19.25
633-C18	3/4" CPVC × 3/4" FIP Swivel, 18"	B	25	25	\$28.00
633-C18PK	3/4" CPVC × 3/4" FIP Swivel, 18"	CI	10	10	\$28.50
633-C24	3/4" CPVC × 3/4" FIP Swivel, 24"	B	25	25	\$33.83
633-C418	3/4" CPVC × 1" FIP Swivel, 18"	B	25	25	\$39.00
<b>VALVED, FULL PORT</b>					
633-CG18FP	3/4" CPVC × 3/4" FIP Swivel, 18"	B	10	10	\$63.00
633-CG18FPT	3/4" CPVC × 3/4" FIP Swivel, w/ 3/4" FIP Branch	B	10	10	\$77.00
633-CG24FP	3/4" CPVC × 3/4" FIP Swivel, 24"	B	10	10	\$68.83
633-CG418FP	3/4" CPVC × 1" FIP Swivel, 18"	B	10	10	\$74.00
<b>THERMAL EXPANSION VALVE, FULL PORT</b>					
633-CG18FRV	3/4" CPVC × 3/4" FIP Swivel, w/ Pressure Relief 3/8" Comp., 18"	B	10	10	\$73.00
633-CG18HRV	3/4" CPVC × 3/4" FIP Swivel, w/ Pressure Relief 3/8" Hose Barb, 18"	B	10	10	\$73.00

## CPVC Water Heater Connector

### Flexible Copper FIP Swivel

- DO NOT use pipe dope on FIP swivel threads
- Do not twist or kink flexible connector
- NL/DZR

Item Number	Item Description	Pkg Type	Min Qty	Case Qty	Price
<b>STANDARD</b>					
634-C118	3/4" CPVC × 3/4" FIP Swivel, 18"	B	25	25	\$24.69
<b>VALVED, FULL PORT</b>					
634-CG118FP	3/4" CPVC × 3/4" FIP Swivel, 18"	B	25	25	\$58.39



634-CG118FP

## CPVC Water Heater Connector

### MIP Straight

- NL/DZR

Item Number	Item Description	Pkg Type	Min Qty	Case Qty	Price
<b>STANDARD</b>					
646-CG318	3/4" CPVC × 3/4" MIP, 18"	B	25	25	\$25.88
<b>VALVED, FULL PORT</b>					
646-CG318FP	3/4" CPVC × 3/4" MIP, 18"	B	10	10	\$69.60



646-CG318FP

## CPVC Water Heater Connector

### Straight FIP Swivel With Expansion Tank Branch

- DO NOT use pipe dope on FIP swivel threads
- NL/DZR

Item Number	Item Description	Pkg Type	Min Qty	Case Qty	Price
633-G3TC06	3/4" × 3/4" FIP Swivel w/ 3/4" CPVC Branch, 6"	B	10	10	\$31.14



633-G3TC06

## CPVC Water Heater Connector

### T&P Relief Adapter

- NL/DZR

Item Number	Item Description	Pkg Type	Min Qty	Case Qty	Price
646-C4308	1" CPVC × 3/4" MIP, 8"	B	25	25	\$23.92



646-C4308

Supply

Drainage

Support

Specialties

Appendix



648-CG2FP



648-CG2FPD

### CPVC Brass Ball Valve

· NL/DZR

Item Number	Item Description	Pkg Type	Min Qty	Case Qty	Price
<b>FULL PORT</b>					
648-CG2FP	1/2" CPVC	B	10	10	\$32.82
648-CG3FP	3/4" CPVC	B	10	10	\$48.76
648-CG4FP	1" CPVC	B	10	10	\$93.97
648-CG5FP	1-1/4" CPVC	B	5	5	\$144.79
648-CG6FP	1-1/2" CPVC	B	1	1	\$201.65
648-CG7FP	2" CPVC	B	1	1	\$314.55
<b>FULL PORT WITH DRAIN</b>					
648-CG2FPD	1/2" CPVC	B	10	10	\$39.83
648-CG3FPD	3/4" CPVC	B	10	10	\$56.53
648-CG4FPD	1" CPVC	B	10	10	\$102.51

### CPVC Sillcock



117-C22

Item Number	Item Description	Pkg Type	Min Qty	Case Qty	Price
<b>LEADED</b>					
117-C22	1/2" CPVC x 3/4" MHT	B	25	25	\$22.98
117-C223E	1/2" CPVC x 3/4" MHT	B	25	25	\$25.14

### CPVC Frost-Proof Anti-Siphon Sillcock



118-C208



119-C208

#### Related Products

Frost-Proof Sillcock Replacement Parts p 124

Item Number	Item Description	Pkg Type	Min Qty	Case Qty	Price
<b>MULTI-TURN - LEADED</b>					
118-C208	1/2" CPVC, 8"	B	5	5	\$44.58
118-C210	1/2" CPVC, 10"	B	5	5	\$47.79
<b>1/4 TURN - LEADED</b>					
119-C208	1/2" CPVC, 8"	B	5	5	\$71.51
119-C210	1/2" CPVC, 10"	B	5	5	\$75.32



## CPVC ShowerUp™ Kit

- Do not allow CPVC portion of fitting to be heated
- For individual product details, see product pages
- NL/DZR

### Related Products

Shower WallNut™ p 640

Item Number	Item Description	Pkg Type	Min Qty	Case Qty	Price
693-01024102	(1) 523-2404, (1) 523-2424, (1) 616-630X, (2) 632-C263X	Bl	1	12	\$74.41
693-06024203	(1) 523-2404, (1) 523-2434, (1) 613-67M, (1) 616-650X, (2) 632-C263X	Bl	12	12	\$100.13

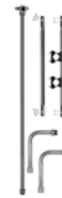

693-01024102

## CPVC Stub Out Elbow Kit

### 1/2" Water Closet Stub Out With Bracket

- Do not allow CPVC portion of fitting to be heated
- For individual product details, see product pages

Item Number	Item Description	Pkg Type	Min Qty	Case Qty	Price
<b>16" STUD BAYS</b>					
689C0101	(1) 525-1612, (1) 630-C248	Bl	12	12	\$13.72
<b>24" STUD BAYS</b>					
689C0111	(1) 525-2412, (1) 630-C248	Bl	12	12	\$14.47



689C0101

## CPVC Stub Out Elbow Kit

### 1/2" Lav/Sink Stub Outs With Bracket

- Do not allow CPVC portion of fitting to be heated
- For individual product details, see product pages

Item Number	Item Description	Pkg Type	Min Qty	Case Qty	Price
<b>16" STUD BAYS</b>					
689C1102	(1) 525-1622, (2) 630-C248	Bl	12	12	\$23.32
<b>24" STUD BAYS</b>					
689C1112	(1) 522-2422, (2) 630-C248	Bl	12	12	\$24.06



689C1102



689C3103

### CPVC Stub Out Elbow Kit

#### 3/4" Water Heater Stub Outs With Bracket

- Do not allow CPVC portion of fitting to be heated
- For individual product details, see product pages

Item Number	Item Description	Pkg Type	Min Qty	Case Qty	Price
689C3103	(1) 525-1623, (2) 630-C348	BI	12	12	\$43.67



689C0191

### CPVC Stub Out Elbow Kit

#### 1/2" Shower Riser Elbow With Bracket

- Do not allow CPVC portion of fitting to be heated
- For individual product details, see product pages

#### Related Products

Shower WallNut™ p 640

Item Number	Item Description	Pkg Type	Min Qty	Case Qty	Price
689C0191	(1) 525-16WLB, (1) 630-C248	BI	12	12	\$15.18



694CG33012091



694CG36012094

### CPVC Water Heater Connector Kit

- DO NOT use pipe dope on FIP swivel threads
- Do not allow CPVC portion of fitting to be heated
- For individual product details, see product pages
- NL/DZR

Item Number	Item Description	Pkg Type	Min Qty	Case Qty	Price
694CG311120	(1) 633-C02, (1) 633-CG09FP	BI	1	10	\$65.29
694CG33012091	(1) 631-CG1307FP, (1) 633-C18, (1) 633-G3TM15	BI	10	10	\$125.76
694CG33012093	(1) 631-CG1307FP, (1) 633-C18, (1) 633-G3TM11	BI	10	10	\$121.87
694CG331220	(1) 633-C18, (1) 633-CG18FP	BI	10	10	\$93.00
694CG36012092	(1) 631-CG1307FP, (1) 633-C418, (1) 633-G4TM15	BI	10	10	\$147.76
<b>694CG36012094</b>	<b>(1) 631-CG1307FP, (1) 633-C418, (1) 633-G4TM11</b>	BI	1	10	\$139.87
694CG361520	(1) 633-C418, (1) 633-CG418FP	BI	10	10	\$115.00
694CG565120	(1) 634-C118, (1) 634-CG118FP	BI	10	10	\$85.08

# ASTM F438 CPVC Systems

## IPS F438 CPVC - Fittings, Adapters & Connectors

Sioux Chief offers iron pipe size (IPS) CPVC transition fittings, which are compatible with FlowGuard Gold® pipe/fittings and are FGG/BM/CZ™ system compatible. The CPVC sockets are GRAY in color, and are made to the ASTM F438 standard.

All fittings are 100% production tested to ensure maximum quality and a leak-free connection.

**Important Notes About Sioux Chief CPVC Fittings:**

Do not cut, or modify any Sioux Chief CPVC transition fitting (except 630-C series fittings). Do not expose CPVC transition area of fitting to heat in excess of 180°F. Never install a damaged fitting.

See complete installation instructions at [www.siouxchief.com](http://www.siouxchief.com)

FlowGuard Gold® and FGG/BM/CZ™ are trademarks of Lubrizol Advanced Materials, Inc.





## Male Sweat Fittings



All Sioux Chief male sweat, preformed copper fittings are compatible with press-fit systems and all push fit systems. Do not use push fittings with nickel-plated stub outs.

## Lead-Free Compliant



Products made from 'Copper' or 'NL/DZR' material comply with NSF-61 & 372 and with the California No Lead Plumbing Law.

## FGG/BM/CZ Compatible



All CPVC connections have been tested to assure chemical compatibility with FlowGuard Gold®, BlazeMaster®, and Corzan® pipe and fittings.  
® Registered trademarks of Lubrizol Corporation.

**CPVC Straight Adapter - IPS Gray**

**F1807**

Item Number	Item Description	Pkg Type	Min Qty	Case Qty	Price
<b>COPPER PVC CUP</b>					
645XC923	1/2" F1807 × 3/4" Sch 40 CPVC	B	25	25	\$12.47
645XC93	3/4" F1807 × 3/4" Sch 40 CPVC	B	50	50	\$12.15
645XC94	1" F1807 × 1" Sch 40 CPVC	B	20	20	\$24.41



645XC93

**CPVC Straight Adapter - IPS Gray**

**F1960**

Item Number	Item Description	Pkg Type	Min Qty	Case Qty	Price
<b>NL/DZR PVC CUP</b>					
645WGC93	3/4" F1960 × 3/4" Sch 40 CPVC	B	50	50	\$18.14
645WGC94	1" F1960 × 1" Sch 40 CPVC	B	20	20	\$29.38
645WGC95	1-1/4" F1960 × 1-1/4" Sch 40 CPVC	B	10	10	\$73.29



645WGC93

**CPVC Straight Adapter - IPS Gray**

**Male Sweat**

- Do not cut this fitting. Cutting this fitting voids warranty
- Do not allow CPVC portion of fitting to be heated.
- Plain copper end is press-fitting compatible

Item Number	Item Description	Pkg Type	Min Qty	Case Qty	Price
<b>COPPER PVC CUP</b>					
643-C9211	1/2" Sch 40 CPVC, 11"	B	25	25	\$11.87
643-C9311	3/4" Sch 40 CPVC, 11"	B	25	25	\$21.41
643-C9418	1" Sch 40 CPVC, 18"	B	25	25	\$40.95



643-C9418

**CPVC Straight Adapter - IPS Gray**

**MIP**

Item Number	Item Description	Pkg Type	Min Qty	Case Qty	Price
<b>NL/DZR BRASS PVC CUP</b>					
646-CG92	1/2" Sch 40 CPVC × 1/2" MIP	B	50	50	\$6.87
646-CG93	3/4" Sch 40 CPVC × 3/4" MIP	B	50	50	\$9.45
646-CG94	1" Sch 40 CPVC × 1" MIP	B	20	20	\$28.45
646-CG95	1-1/4" Sch 40 CPVC × 1-1/4" MIP	B	10	10	\$50.74
646-CG96	1-1/2" Sch 40 CPVC × 1-1/2" MIP	B	10	10	\$63.88
646-CG97	2" Sch 40 CPVC × 2" MIP	B	10	10	\$96.89



646-CG96

Supply

Drainage

Support

Specialties

Appendix



647-CG97

### CPVC Straight Adapter - IPS Gray

#### FIP

Item Number	Item Description	Pkg Type	Min Qty	Case Qty	Price
<b>NL/DZR BRASS PVC CUP</b>					
647-CG92	1/2" Sch 40 CPVC × 1/2" FIP	B	50	50	\$6.87
647-CG93	3/4" Sch 40 CPVC × 3/4" FIP	B	50	50	\$10.67
647-CG94	1" Sch 40 CPVC × 1" FIP	B	20	20	\$28.45
647-CG95	1-1/4" Sch 40 CPVC × 1-1/4" FIP	B	10	10	\$52.09
647-CG96	1-1/2" Sch 40 CPVC × 1-1/2" FIP	B	10	10	\$65.58
647-CG97	2" Sch 40 CPVC × 2" FIP	B	10	10	\$99.50



630-C93612

### CPVC Stub Out Elbow - IPS Gray

· Do not allow CPVC portion of fitting to be heated.

Item Number	Item Description	Pkg Type	Min Qty	Case Qty	Price
630-C9248	1/2" Sch 40 CPVC, 4" × 8"	B	50	50	\$10.91
630-C93612	3/4" Sch 40 CPVC, 6" × 12"	B	25	25	\$32.39
630-C941012	1" Sch 40 CPVC, 10" × 12"	B	25	25	\$58.07

# PVC Systems

## PVC Fittings & Valves

Sioux Chief offers the most complete line of Sch. 40 PVC transition fittings for potable water or irrigation systems in the industry.

Sioux Chief PVC fittings conform to ASTM F1970 standard for use in PVC piping systems and are designed for use with Sch. 40 PVC pipe conforming to ASTM D1785.

**Important Notes About Sioux Chief PVC Fittings:**

Do not expose PVC transition area of fitting to heat in excess of 140°F.

PVC fittings are intended for use in cold water applications only.

Do not cut, or modify any Sioux Chief PVC transition fitting.

Never install a damaged fitting.



See complete installation instructions at [www.siouxchief.com](http://www.siouxchief.com)



---

### Male Sweat Fittings

**PRESS-FIT  
COMPATIBLE** All Sioux Chief male sweat, preformed copper fittings are compatible with press-fit systems and all push fit systems. Do not use push fittings with nickel-plated stub outs.

### Lead-Free Compliant

**LEAD  
FREE  
COMPLIANT**

Products made from 'Copper' or 'NL/DZR' material comply with NSF-61 & 372 and with the California No Lead Plumbing Law.



## PVC Straight Adapter

### F1807

Item Number	Item Description	Pkg Type	Min Qty	Case Qty	Price
<b>COPPER PVC CUP</b>					
645X23P	1/2" F1807 × 3/4" PVC	B	50	50	\$12.53
645X34P	3/4" F1807 × 1" PVC	B	20	20	\$18.73
645X3P	3/4" F1807 × 3/4" PVC	B	50	50	\$11.89
645X43P	1" F1807 × 3/4" PVC	B	20	20	\$18.86
645X4P	1" F1807 × 1" PVC	B	20	20	\$19.64



645X3P

## PVC Straight Adapter

### F1960

Item Number	Item Description	Pkg Type	Min Qty	Case Qty	Price
<b>NL/DZR PVC CUP</b>					
645WG3P	3/4" F1960 × 3/4" PVC	B	50	50	\$15.97
645WG4P	1" F1960 × 1" PVC	B	20	20	\$29.38



645WG3P

## PVC Straight Adapter

### Male Sweat

- DO NOT cut this fitting. Cutting this fitting voids warranty
- Do not allow PVC portion of fitting to be heated.

Item Number	Item Description	Pkg Type	Min Qty	Case Qty	Price
<b>COPPER PVC CUP</b>					
643-P311	3/4" PVC × 3/4" MSWT, 11"	B	50	50	\$22.07
643-P418	1" PVC × 1" MSWT, 18"	B	25	25	\$42.98
643-P518	1-1/4" PVC × 1-1/4" MSWT, 18"	B	1	10	\$58.31
643-P620	1-1/2" PVC × 1-1/2" MSWT, 20"	B	1	10	\$69.92
643-P722	2" PVC × 2" MSWT, 22"	B	1	10	\$136.19



643-P418

Supply

Drainage

Support

Specialties

Appendix



646-PG3



646-PG5



647-PG3



647-PG5



685-P3

## PVC Straight Adapter

### MIP

Item Number	Item Description	Pkg Type	Min Qty	Case Qty	Price
<b>NL/DZR COPPER ASSEMBLY</b>					
646-PG3	3/4" PVC × 3/4" MIP	B	50	50	\$14.37
646-PG4	1" PVC × 1" MIP	B	20	20	\$22.62
<b>NL/DZR BRASS ROLL OVER</b>					
646-PG5	1-1/4" PVC × 1-1/4" MIP	B	10	10	\$32.20
646-PG6	1-1/2" PVC × 1-1/2" MIP	B	10	10	\$67.39
646-PG7	2" PVC × 2" MIP	B	10	10	\$91.33

## PVC Straight Adapter

### FIP

Item Number	Item Description	Pkg Type	Min Qty	Case Qty	Price
<b>NL/DZR COPPER ASSEMBLY</b>					
647-PG3	3/4" PVC × 3/4" FIP	B	50	50	\$17.09
647-PG4	1" PVC × 1" FIP	B	20	20	\$26.25
<b>NL/DZR BRASS ROLL OVER</b>					
647-PG5	1-1/4" PVC × 1-1/4" FIP	B	10	10	\$58.88
647-PG6	1-1/2" PVC × 1-1/2" FIP	B	10	10	\$79.13
647-PG7	2" PVC × 2" FIP	B	10	10	\$119.81

## PVC Straight Adapter

### Press-Fitting and Push Fit Compatible

- Mechanical connection only
- Applying heat or cutting this fitting voids warranty
- Plain copper end is press-fitting compatible

Item Number	Item Description	Pkg Type	Min Qty	Case Qty	Price
<b>COPPER PVC CUP</b>					
685-P3	3/4" PVC × 3/4" Press-Fit	B	20	20	\$10.65
685-P4	1" PVC × 1" Press-Fit	B	20	20	\$14.83
685-P5	1-1/4" PVC × 1-1/4" Press-Fit	B	10	10	\$24.46
685-P6	1-1/2" PVC × 1-1/2" Press-Fit	B	5	5	\$34.39
685-P7	2" PVC × 2" Press-Fit	B	5	5	\$46.65

### PVC Brass Ball Valve

· NL/DZR

Item Number	Item Description	Pkg Type	Min Qty	Case Qty	Price
<b>FULL PORT</b>					
648-PG3FP	3/4" PVC	B	10	10	\$57.26
648-PG4FP	1" PVC	B	10	10	\$101.74
648-PG5FP	1-1/4" PVC	B	5	5	\$151.99
648-PG6FP	1-1/2" PVC	B	1	1	\$179.50
648-PG7FP	2" PVC	B	1	1	\$325.40



648-PG3FP

Supply

Drainage

Support

Specialties

Appendix



# Sweat Systems

**Sweat Fittings, Adapters & Valves**

**Sweat Manifolds**



Spun-closed ends eliminate the need to solder on caps, while stub out elbows use a longer bend radius than standard fittings to decrease turbulent flow, reducing water line noise, potential leak points, water stacking in showers, and can provide better flow to fixtures.

All copper tube used in Sioux Chief preformed copper assemblies is domestically made and is fabricated/assembled in Missouri. The copper tube is made to ASTM B88 and fitting ends are made to ANSI B16.22



**614-2**  
Page 111



**616-2E3**  
Page 111



**609-L2138**  
Page 113



**609-L246E**  
Page 114



**613-57M**  
Page 115



**622-L08**  
Page 115



**609-L263A**  
Page 116



**616-648**  
Page 116



**631-G305FP**  
Page 117



**633-318**  
Page 118



**634-115**  
Page 119



**633-G3TM15**  
Page 119



**633-G3TM18FP**  
Page 119



**636-L3888**  
Page 121



**601-G20CV**  
Page 121



**646-GP4312FD**  
Page 121



**104-G23**  
Page 122



**117-12**  
Page 123



**118M208**  
Page 123



**117-03**  
Page 125

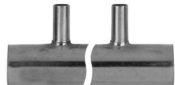

**678-20344**  
Page 126

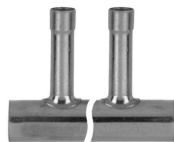

**67745L-08334**  
Page 127



**675-V20244**  
Page 128



**693-13155301**  
Page 129

**Full Slip Male Adapter**

**Brass Female Sweat × MIP**

Item Number	Item Description	Pkg Type	Min Qty	Case Qty	Price
<b>LEADED</b>					
614-2	1/2" FSWT × 1/2" MIP Thread	B	50	500	\$2.55
614-3	3/4" FSWT × 3/4" MIP Thread	B	50	500	\$3.67
614-4	1" FSWT × 1" MIP Thread	B	25	250	\$7.85



614-2

**Wal-Let™**

**Wall Termination Fitting**

Item Number	Item Description	Pkg Type	Min Qty	Case Qty	Price
<b>LEADED</b>					
615-213	1/2" FIP × 1/2" FSWT	B	10	10	\$15.58
615-233	1/2" FIP × 1/2" FIP	B	10	10	\$18.56
615-313	3/4" FIP × 3/4" FSWT	B	10	10	\$31.90
615-333	3/4" FIP × 3/4" FIP	B	10	10	\$31.90
615-C2113	1/2" FIP × 1/2" CPVC, 11" Straight	B	25	25	\$31.90
615-C215	1/2" FIP × 1/2" CPVC, 1-5/8" Straight	B	10	10	\$23.01
615W216	1/2" FIP × 1/2" F1960	B	25	25	\$27.16

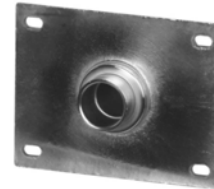

615-213

**Sweat Elbow Adapter**

**Tub Shower Elbow**

**Related Products**

Shower Arm Test Plug p 467

WiderSlider™ Adjustable Bracket p 529

Item Number	Item Description	Pkg Type	Min Qty	Case Qty	Price
<b>DROP-EAR - LEADED</b>					
616-2E3	1/2" FIP × 1/2" FSWT	B	50	50	\$8.95
616-3E3	3/4" FIP × 3/4" FSWT	B	25	25	\$11.78
<b>SHOWER-LOCK - LEADED</b>					
616-2	1/2" FSWT × 1/2" FIP	B	50	50	\$14.99
616-2PK2	1/2" FSWT × 1/2" FIP, 1/Bag	Cl	10	10	\$15.49



616-2E3



616-2

Supply

Drainage

Support

Specialties

Appendix



637-G23H

### Elbow Adapter

#### Dishwasher Elbow

· DO NOT use pipe dope on threads

Item Number	Item Description	Pkg Type	Min Qty	Case Qty	Price
<b>NL/DZR BRASS</b>					
637-G23H	3/4" Female Hose Thread × 3/8" OD Comp., Short Radius, Heavy-Duty Hose Nut, Rough Brass, 1/Bag	B	20	20	\$7.49



929-01302001

### Sweat Dielectric Union

Item Number	Item Description	Pkg Type	Min Qty	Case Qty	Price
929-01302001	3/4" FIP × 1/2" SWT	BI	5	20	\$16.96
929-01303001	3/4" FIP × 3/4" SWT	BI	5	60	\$16.69
929-02302001	3/4" MIP × 1/2" SWT	BI	5	20	\$15.42



Termination Fitting

FIP

Item Number	Item Description	Pkg Type	Min Qty	Case Qty	Price
<b>MALE SWEAT</b>					
622-L09CF	1/2" FIP x 1/2" MSWT, 1/2" CTS, 9"	B	25	25	\$16.09



Sweat Coupling

Full Slip Repair Coupling

Item Number	Item Description	Pkg Type	Min Qty	Case Qty	Price
<b>FEMALE SWEAT</b>					
600-206PK	1/2" CTS, 6"	Cl	10	10	\$5.06
600-212PK	1/2" CTS, 12"	Cl	10	10	\$9.00
600-306PK	3/4" CTS, 6"	Cl	10	10	\$6.90
600-312PK	3/4" CTS, 12"	Cl	10	10	\$13.01



Sweat Stub Out Elbow

Item Number	Item Description	Pkg Type	Min Qty	Case Qty	Price
<b>MALE SWEAT</b>					
608-L2138	1/2" CTS, 13" x 8"	B	50	50	\$12.79
608-L2187	1/2" CTS, 18" x 7"	B	50	50	\$15.68
608-L2277	1/2" CTS, 27" x 7"	B	50	50	\$22.41
608-L246	1/2" CTS, 3-1/2" x 6"	B	50	50	\$5.75
608-L248	1/2" CTS, 3-1/2" x 8"	B	50	50	\$6.74
608-L2612	1/2" CTS, 6" x 12"	B	50	50	\$11.10
608-L2812	1/2" CTS, 8" x 12"	B	50	50	\$12.27
608-L348	3/4" CTS, 4" x 8"	B	50	50	\$13.34
608-L4612	1" CTS, 6" x 12"	B	25	25	\$32.54
<b>FEMALE SWEAT</b>					
609-L2138	1/2" CTS, 13" x 8"	B	50	50	\$13.12
609-L246	1/2" CTS, 3-1/2" x 6"	B	50	50	\$6.08
609-L248	1/2" CTS, 3-1/2" x 8"	B	50	50	\$7.09
609-L2612	1/2" CTS, 6" x 12"	B	50	50	\$12.61
609-L2812	1/2" CTS, 8" x 12"	B	50	50	\$12.61
609-L348	3/4" CTS, 4" x 8"	B	50	50	\$13.66
609-L4612	1" CTS, 6" x 12"	B	25	25	\$32.86
609-L4812	1" CTS, 8" x 12"	B	25	25	\$36.64



Supply

Drainage

Support

Specialties

Appendix

Supply

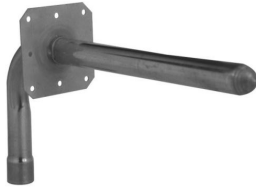

609-L246E

### Sweat Stub Out Elbow Square O Strap

Item Number	Item Description	Pkg Type	Min Qty	Case Qty	Price
<b>FEMALE SWEAT</b>					
609-L246E	1/2" CTS, 3-1/2" x 6", w/ Strap	B	25	25	\$7.07
609-L248E	1/2" CTS, 3-1/2" x 8", w/ Strap	B	25	25	\$8.08

Drainage



608-D288E

### Sweat Stub Out Elbow Double Stub Out

**Related Products**

3-Valve Kitchen Supply Box p 195

Item Number	Item Description	Pkg Type	Min Qty	Case Qty	Price
<b>MALE SWEAT</b>					
608-D288E	1/2" CTS, Type L, 7" x 8" x 8" w/ Strap	B	25	25	\$22.49

Support

Specialties



613-887L

### Sweat Stub Out Elbow Male Sweat Offset

Item Number	Item Description	Pkg Type	Min Qty	Case Qty	Price
613-887L	1/2" CTS, Left, Type L	B	25	25	\$15.72
613-887R	1/2" CTS, Right, Type L	B	25	25	\$15.72

Appendix



613-139

### Sweat Tub Spout Elbow

- DO NOT use pipe dope on FIP swivel threads
- NL/DZR

**Related Products**

SmartSpout™ Tub Spout p 639

Item Number	Item Description	Pkg Type	Min Qty	Case Qty	Price
<b>MALE SWEAT</b>					
613-107	1/2" CTS, 10" x 7", Type L	B	50	50	\$10.28
613-137	1/2" CTS, 13" x 7", Type L	B	50	50	\$12.37
613-139	1/2" CTS, 13" x 9", Type L	B	50	50	\$13.84
613-57	1/2" CTS, 5" x 7", Type L	B	50	50	\$7.20
613-57PK	1/2" CTS, 5" x 7", Type L	CI	20	20	\$7.70
613-67	1/2" CTS, 6" x 7", Type L	B	50	50	\$7.76
613-87	1/2" CTS, 8" x 7", Type L	B	50	50	\$8.57
<b>MALE SWEAT WITH SQUARE O STRAP</b>					
613-87E	1/2" CTS, 8" x 7", Type L	B	25	25	\$9.58



613-87E

Sweat Tub Spout Elbow (Cont)

Item Number	Item Description	Pkg Type	Min Qty	Case Qty	Price
<b>MALE SWEAT WITH WALL BLOCK</b>					
612-108	1/2" CTS, 10" x 8", Type L	B	25	25	\$12.67
612-57	1/2" CTS, 5" x 7", Type L	B	25	25	\$8.52
612-87	1/2" CTS, 8" x 7", Type L	B	25	25	\$9.90
<b>MIP SWIVEL</b>					
613-57X	1/2" CTS, 5" x 7", Type L	B	50	50	\$14.16
613-67X	1/2" CTS, 6" x 7", Type L	B	50	50	\$14.72
613-87X	1/2" CTS, 8" x 7", Type L	B	50	50	\$15.56
<b>MIP</b>					
613-57M	1/2" CTS, 5-1/2" x 7", Type L	B	50	50	\$11.12
613-67M	1/2" CTS, 6-1/2" x 7", Type L	B	50	50	\$11.67
613-87M	1/2" CTS, 8-1/2" x 7", Type L	B	50	50	\$12.53
<b>MIP WITH WALL BLOCK</b>					
612-557	1/2" CTS, 5-1/2" x 7", Type L	B	25	25	\$12.49
<b>FIP SWIVEL</b>					
613-57Y	1/2" CTS, 5" x 7", Type L	B	50	50	\$13.47
613-67Y	1/2" CTS, 6" x 7", Type L	B	50	50	\$14.03
613-87Y	1/2" CTS, 8" x 7", Type L	B	50	50	\$14.90
<b>FIP</b>					
613-67F	1/2" CTS, 6" x 7", Type L	B	50	50	\$11.74



612-57



613-57X



613-57Y

Sweat Bullet™

Male Sweat

· Not to be used as permanent air chambers

Item Number	Item Description	Pkg Type	Min Qty	Case Qty	Price
<b>SPUN CLOSED</b>					
622-L03	1/2" CTS, 3", Type L	B	100	100	\$2.38
622-L06	1/2" CTS, 6", Type L	B	100	100	\$3.58
622-L06PK	1/2" CTS, 6", Type L	Cl	20	20	\$4.08
622-L08	1/2" CTS, 8", Type L	B	100	100	\$4.57
622-L08PK	1/2" CTS, 8", Type L	Cl	10	10	\$5.07
622-L10	1/2" CTS, 10", Type L	B	100	100	\$5.80
622-L12	1/2" CTS, 12", Type L	B	100	100	\$6.89
622-L12PK	1/2" CTS, 12", Type L	Bl	10	10	\$7.39
622-L15	1/2" CTS, 15", Type L	B	100	100	\$8.49
623-L06	3/4"CTS, 6", Type L	B	50	50	\$7.34
623-L08	3/4" CTS, 8", Type L	B	50	50	\$9.39
623-L12	3/4" CTS, 12", Type L	B	50	50	\$14.10
623-L18	3/4" CTS, 18", Type L	B	50	50	\$20.57
624-L08	1" CTS, 8", Type L	B	30	30	\$14.82
624-L12	1" CTS, 12" Type L	B	30	30	\$19.59
624-L15	1" CTS, 15", Type L	B	30	30	\$24.24
624-L18	1" CTS, 18", Type L	B	30	30	\$27.47
<b>SPUN CLOSED WITH STRAP</b>					
622-L24E	1/2" CTS, 24" Long, 12" Stub Out, Type L	B	20	20	\$15.16



622-L06



622-L24E

Supply

Drainage

Support

Specialties

Appendix



614-8L

### Sweat Bullet™

#### MIP

- Not to be used as permanent air chambers
- NL/DZR

Item Number	Item Description	Pkg Type	Min Qty	Case Qty	Price
614-8L	1/2" CTS, 8-1/2", Type L	B	50	50	\$8.53



609-L263A

### Sweat Tub/Shower Pressure Connector

Item Number	Item Description	Pkg Type	Min Qty	Case Qty	Price
608-L263A	1/2" MSWT × 1/2" MSWT, 2-1/4" × 6"	B	50	50	\$5.81
609-L263A	1/2" MSWT × 1/2" FSWT, 2-1/4" × 6"	B	50	50	\$6.14
609-L27	1/2" MSWT × 1/2" FSWT, 1-1/2" × 6"	B	50	50	\$9.94



608-L2308

### Riser Stub Out

- DO NOT use pipe dope on FIP swivel threads
- NL/DZR

#### Related Products

Shower WallNut™ p 640

Item Number	Item Description	Pkg Type	Min Qty	Case Qty	Price
<b>MALE SWEAT</b>					
608-L2308	1/2" MSWT × Spun, 30" × 8"	B	25	25	\$25.36
608-L2508	1/2" MSWT × Spun, 50" × 8"	B	25	25	\$36.89
616-630	1/2" MSWT × 1/2" FIP Drop-Ear, 30"	B	50	50	\$27.79
616-648	1/2" MSWT × 1/2" FIP Drop-Ear, 48"	B	12	12	\$33.16
616-650	1/2" MSWT × 1/2" FIP Drop-Ear, 50"	B	25	25	\$40.71
<b>MALE SWEAT WITH SQUARE O STRAP</b>					
608-L2508E	1/2" MSWT × Spun, 50" × 8", w/ Strap	B	25	25	\$37.87
<b>MIP SWIVEL</b>					
616-630X	1/2" MIP Swivel × 1/2" FIP Drop-Ear, 30"	B	50	50	\$34.58
616-650X	1/2" MIP Swivel × 1/2" FIP Drop-Ear, 50"	B	25	25	\$47.53
<b>FIP SWIVEL</b>					
616-630Y	1/2" FIP Swivel × 1/2" FIP Drop-Ear, 30"	B	50	50	\$33.92
616-650Y	1/2" FIP Swivel × 1/2" FIP Drop-Ear, 50"	B	25	25	\$46.82

Riser Stub Out

Offset

Item Number	Item Description	Pkg Type	Min Qty	Case Qty	Price
<b>MALE SWEAT</b>					
616-15	1/2" MSWT x 1/2" FSWT, 1-1/2" Offset	B	25	25	\$5.57



616-15

Water Heater Connector

Female Sweat x FIP Elbow

- DO NOT use pipe dope on FIP swivel threads
- NL/DZR

Item Number	Item Description	Pkg Type	Min Qty	Case Qty	Price
<b>STANDARD</b>					
631-33F	3/4" FIP Swivel x 3/4" FSWT, 3" x 3"	B	25	25	\$14.76
<b>VALVED, FULL PORT</b>					
631-G305FP	3/4" FIP Swivel x 3/4" FSWT, 3" x 5"	B	25	25	\$48.26



631-33F



631-G305FP

Water Heater Connector

FIP Swivel Elbow

- DO NOT use pipe dope on FIP swivel threads
- NL/DZR

Item Number	Item Description	Pkg Type	Min Qty	Case Qty	Price
631-33	3/4" FIP Swivel x 3/4" FIP Swivel, 3" x 3"	B	1	25	\$16.76



631-33

Supply

Drainage

Support

Specialties

Appendix



633-318



633-G318FP



633-4312



633-G312FP



634-318

## Water Heater Connector

### FIP Swivel x Male Sweat

- DO NOT use pipe dope on FIP swivel threads
- NL/DZR

Item Number	Item Description	Pkg Type	Min Qty	Case Qty	Price
<b>STANDARD</b>					
633-318	3/4" FIP Swivel x 3/4" MSWT, 18"	B	10	10	\$22.00
<b>VALVED, FULL PORT</b>					
633-G318FP	3/4" FIP Swivel x 3/4" MSWT, 18"	B	10	10	\$58.50

## Water Heater Connector

### FIP Swivel x Full-Slip Female Sweat

- DO NOT use pipe dope on FIP swivel threads
- NL/DZR

Item Number	Item Description	Pkg Type	Min Qty	Case Qty	Price
<b>STANDARD</b>					
633-312	3/4" FIP Swivel x 3/4" Full-Slip FSWT	B	25	25	\$17.66
633-4312	1" FIP Swivel x 3/4" Full-Slip FSWT	B	25	25	\$24.88
<b>VALVED, FULL PORT</b>					
633-G312FP	3/4" FIP Swivel x 3/4" Full-Slip FSWT	B	10	10	\$52.66

## Water Heater Connector

### Flexible Copper Water Heater Connector

- DO NOT use pipe dope on FIP swivel threads
- Do not twist or kink flexible connector
- NL/DZR

Item Number	Item Description	Pkg Type	Min Qty	Case Qty	Price
<b>FIP x FSWT</b>					
634-315	3/4" FIP Swivel x 3/4" FSWT, 15"	B	12	12	\$15.39
634-318	3/4" FIP Swivel x 3/4" FSWT, 18"	B	12	12	\$16.69
634-324	3/4" FIP Swivel x 3/4" FSWT, 24"	B	12	12	\$20.16

## Water Heater Connector (Cont)

### Flexible Copper Water Heater Connector

Item Number	Item Description	Pkg Type	Min Qty	Case Qty	Price
<b>FIP X FIP</b>					
634-112	3/4" FIP x 3/4" FIP Swivel, 12"	B	12	12	\$15.22
634-112PK5	3/4" FIP x 3/4" FIP Swivel, 12"	BI	5	5	\$15.32
634-115	3/4" FIP Swivel x 3/4" FIP Swivel, 15"	B	12	12	\$17.39
634-118	3/4" FIP Swivel x 3/4" FIP Swivel, 18"	B	12	12	\$18.69
634-118PK5	3/4" FIP x 3/4" FIP Swivel, 18"	BI	5	5	\$18.79
634-124	3/4" FIP x 3/4" FIP Swivel, 24"	B	12	12	\$22.16
634-124PK5	3/4" FIP x 3/4" FIP Swivel, 24"	BI	5	5	\$22.26



634-115

## Water Heater Connector

### FIP Swivel With Expansion Tank Branch

- DO NOT use pipe dope on FIP swivel threads
- NL/DZR

Item Number	Item Description	Pkg Type	Min Qty	Case Qty	Price
633-G3TM11	3/4" x 3/4" FIP Swivel w/ 3/4" MIP Branch, 11"	B	25	25	\$35.69
633-G3TM15	3/4" x 3/4" FIP Swivel w/ 3/4" MIP Branch, 15"	B	25	25	\$39.58
633-G4TM11	1" x 3/4" FIP Swivel w/ 3/4" MIP Branch, 11"	B	25	25	\$42.69
633-G4TM15	1" x 3/4" FIP Swivel w/ 3/4" MIP Branch, 15"	B	25	25	\$50.58



633-G3TM15

## Water Heater Connector

### Valved With Expansion Tank Branch, Full Port

- DO NOT use pipe dope on FIP swivel threads
- NL/DZR

Item Number	Item Description	Pkg Type	Min Qty	Case Qty	Price
<b>MALE SWEAT</b>					
633-G3TM18FP	3/4" FIP Swivel x 3/4" MSWT, w/ 3/4" MIP Branch, 18"	B	1	25	\$74.00
<b>FULL SLIP</b>					
633-G3TM18FPF	3/4" FIP Swivel x 3/4" Full Slip, w/ 3/4" MIP Branch, 18"	B	1	25	\$75.50



633-G3TM18FP



633-G3TM18FPF

Supply

Drainage

Support

Specialties

Appendix



634-3F312

## Water Heater Connector

### Corrugated Flexible SS Connectors

- DO NOT use pipe dope on FIP swivel threads
- Do not twist or kink flexible connector
- NL/DZR

Item Number	Item Description	Pkg Type	Min Qty	Case Qty	Price
634-3F3F12	3/4" FIP x 3/4" FIP x 12", Stainless Steel	BI	10	10	\$13.09
634-3F3F18	3/4" FIP x 3/4" FIP x 18", Stainless Steel	BI	10	10	\$15.02
634-3F3F24	3/4" FIP x 3/4" FIP x 24", Stainless Steel	BI	10	10	\$16.13



687-3SMFH



687-3SMKIT



648-3SM

## Cross Adapters

Item Number	Item Description	Pkg Type	Min Qty	Case Qty	Price
<b>CROSS ADAPTERS</b>					
687-3SFMH	Cross Adapter - 3/4" FIP Swivel X 3/4" FIP X 3/4" MIP X 3/4" MHT w/ Cap	BI	5	5	\$20.00
687-3SMFH	Cross Adapter - 3/4" FIP Swivel X 3/4" MIP X 3/4" FIP X 3/4" MHT w/ Cap	BI	5	5	\$20.00
687-3SMMH	Cross Adapter - 3/4" FIP Swivel X 3/4" MIP X 3/4" MIP X 3/4" MHT w/ Cap	BI	5	5	\$20.00
<b>CROSS ADAPTER KITS</b>					
687-3SMKIT	Cross Adapter Kit - Includes 687-3SM / 687-3SMFH / 687-3SMMH	BI	5	5	\$73.00
<b>VALVES</b>					
648-3SM	3/4" FIPS x 3/4" MIP	BI	5	5	\$33.66
648-3SW	3/4" FIPS x 3/4" F1960	BI	1	5	TBD
648-3SX	3/4" FIPS x 3/4" F1807	X	5	5	\$33.66

## Water Softener Connector

### Corrugated SS Connectors

- DO NOT use pipe dope on FIP swivel threads
- Do not twist or kink flexible connector
- NL/DZR



634-4F3F18

Item Number	Item Description	Pkg Type	Min Qty	Case Qty	Price
634-4F3F18	1" FIP x 3/4" FIP x 18", Stainless Steel	BI	10	10	\$15.28
634-4F4F18	1" FIP x 1" FIP x 18", Stainless Steel	BI	10	10	\$20.06



Heat Trap Loop

Item Number	Item Description	Pkg Type	Min Qty	Case Qty	Price
636-3TR	3/4" MSWT × 3/4" MSWT	B	25	25	\$24.24



636-3TR

Water Heater Stub Out Loop

Item Number	Item Description	Pkg Type	Min Qty	Case Qty	Price
636-3L10888	3/4" MSWT	B	10	10	\$55.52
636-4L10888	1" MSWT	B	10	10	\$74.87
636-L3888	3/4" MSWT	B	25	25	\$27.18



636-L3888

Add-A-Line™

Full Slip Valve Tee

- DO NOT use pipe dope on comp. threads
- NL/DZR

Item Number	Item Description	Pkg Type	Min Qty	Case Qty	Price
<b>COMPRESSION TRUNK</b>					
601-G20CV	5/8" O.D. Comp × 1/4" OD Comp	Cl	6	6	\$35.89
601-G21CV	5/8" O.D. Comp × 3/8" OD Comp	Cl	6	6	\$39.77
601-G30CV	7/8" O.D. Comp × 1/4" OD Comp	Cl	6	6	\$46.70



601-G20CV

Water Service Connectors

- DO NOT use pipe dope on FIP swivel threads
- NL/DZR

Item Number	Item Description	Pkg Type	Min Qty	Case Qty	Price
<b>POLY WATER SERVICE CONNECTOR</b>					
646-GP4312FD	1" IPS-ID Barb × 3/4" MIP, 12"	B	25	25	\$91.49
646-GP4412FD	1" IPS-ID Barb × 1" MIP, 12"	B	25	25	\$119.54



646-GP4312FD

Supply

Drainage

Support

Specialties

Appendix



692-1308



969-014440304001



104-G22



105-G22



648-3SMARX

### Water Meter Adapters

· NL/DZR

Item Number	Item Description	Pkg Type	Min Qty	Case Qty	Price
<b>WATER METER EXTENSION NIPPLE</b>					
692-1308	3/4" MIP × 1" FIP Swivel, 8"	B	25	25	\$31.24
<b>BRASS WATER METER ADAPTER</b>					
969-014440304001	1" FIP × 3/4" MIP w/ Washer, 1/Bag	BI	2	24	\$27.06

### Sweat Brass Ball Valve

· NL/DZR Brass

Item Number	Item Description	Pkg Type	Min Qty	Case Qty	Price
<b>FULL PORT</b>					
104-G22	1/2" FSWT	B	8	8	\$24.77
104-G23	3/4" FSWT	B	8	8	\$41.39
104-G24	1" FSWT	B	5	40	\$68.81
<b>FULL PORT WITH DRAIN</b>					
105-G22	1/2" FSWT	B	7	70	\$38.17
105-G23	3/4" FSWT	B	5	40	\$53.55
105-G24	1" FSWT	B	3	15	\$73.50
<b>THERMAL EXPANSION VALVE - 125 PSI</b>					
648-WG3CR	3/4" F1960 × 3/4" FSWT, 3/8" Comp. Port	BI	6	6	\$40.00
648-WG3HR	3/4" F1960 × 3/4" FSWT, 3/8" Hose Barb Port	BI	6	6	\$40.00
648-WG3WR	3/4" F1960 × 3/4" FSWT, 1/2" F1960 Port	BI	6	6	\$40.00
648-XG3CR	3/4" F1807 × 3/4" FSWT, 3/8" Comp. Port	BI	6	6	\$40.00
648-XG3HR	3/4" F1807 × 3/4" FSWT, 3/8" Hose Barb Port	BI	6	6	\$40.00
648-XG3XR	3/4" F1807 × 3/4" FSWT, 1/2" F1807 Port	BI	6	6	\$40.00
<b>THERMAL EXPANSION VALVE - ADJUSTABLE, FULL PORT</b>					
648-3SMARX	3/4" FIP Swivel × 3/4" MIP, 1/2" F1807 Port (80-125 PSI)	BI	6	6	\$45.00
<b>ADJUSTABLE REPLACEMENT RELIEF PORT</b>					
648-ARX	1/8" MIP × 1/2" F1807 (80-125 PSI)	BI	6	6	\$9.80

**Brass Stop & Waste Valve**

· NL/DZR Brass

Item Number	Item Description	Pkg Type	Min Qty	Case Qty	Price
111-G22	1/2" FSWT	B	10	100	\$9.96
111-G23	3/4" FSWT	B	10	100	\$11.94



111-G22

**Brass Boiler Drain**

Item Number	Item Description	Pkg Type	Min Qty	Case Qty	Price
<b>LEADED</b>					
113-32	1/2" MIP/FSWT × 3/4" MHT	BI	10	100	\$12.24
113-33	3/4" MIP × 3/4" MHT	BI	10	100	\$13.67



113-33

**Sillcock**

**Standard**

**Related Products**  
PDQ™ Sillcock p 139

Item Number	Item Description	Pkg Type	Min Qty	Case Qty	Price
<b>1/2" FIP - LEADED</b>					
117-12	1/2" FIP × 3/4" Male Hose Thread	B	10	100	\$14.03
<b>1/2" FSWT - LEADED</b>					
117S2	1/2" FSWT × 3/4" Male Hose Thread	BI	10	100	\$21.36



117-12



117S2

**Frost-Proof Anti-Siphon Sillcock**

Item Number	Item Description	Pkg Type	Min Qty	Case Qty	Price
<b>MULTI-TURN - LEADED</b>					
118M204	1/2" MIP/FSWT × 3/4" MHT, 4"	BI	1	40	\$31.54
118M206	1/2" MIP/FSWT × 3/4" MHT, 6"	BI	1	40	\$32.80
118M208	1/2" MIP/FSWT × 3/4" MHT, 8"	BI	1	40	\$33.44
118M210	1/2" MIP/FSWT × 3/4" MHT, 10"	BI	1	40	\$35.52
118M212	1/2" MIP/FSWT × 3/4" MHT, 12"	BI	1	40	\$36.79



118M208

Supply

Drainage

Support

Specialties

Appendix

Supply

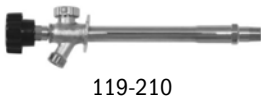

119-210



119-210CPK

### Frost-Proof Anti-Siphon Sillcock (Cont)

Item Number	Item Description	Pkg Type	Min Qty	Case Qty	Price
<b>1/4 TURN - LEADED</b>					
119-204	1/2" MIP x 3/4" MHT x 1/2" FSWT, 4"	B	1	25	\$53.06
119-206	1/2" MIP x 3/4" MHT x 1/2" FSWT, 6"	B	1	25	\$58.04
119-208	1/2" MIP x 3/4" MHT x 1/2" FSWT, 8"	B	1	25	\$59.97
119-210	1/2" MIP x 3/4" MHT x 1/2" FSWT, 10"	B	1	25	\$63.80
119-210CPK	5/8" O.D. Comp. x 3/4" MHT, 10"	CI	5	5	\$64.05
119-212	1/2" MIP x 3/4" MHT x 1/2" FSWT, 12"	B	1	25	\$71.45

Drainage

Support



118-01



118-07



118-08



119-01



119-0904

### Frost-Proof Sillcock Replacement Parts

Item Number	Item Description	Pkg Type	Min Qty	Case Qty	Price
<b>118 SERIES</b>					
118-01	Sillcock Handle, Die Cast	B	12	12	\$3.64
118-02	Handle Screw	B	12	12	\$0.32
118-03	Faceplate And Stem Packing Washers	B	1	1	\$1.77
118-04	Stem Packing	B	12	12	\$0.54
118-05	Neoprene Seat Washer	B	12	12	\$0.18
118-06	Seat Washer Screw	B	1	1	\$0.57
118-07	Stem Bottom Assembly Parts: S.S. Spring, O-Ring, Spring Seat, Flat Gasket, Retainer Cup, Stem Packing, Seat Screw	B	1	1	\$4.76
118-08	Vacuum Breaker Repair Kit: Cap, Plunger, O-Ring	B	1	1	\$4.47
118-0904	4" Complete Stem Assembly: Includes Stem Bottom Assembly	B	1	1	\$14.13
118-0906	6" Complete Stem Assembly: Includes Stem Bottom Assembly	B	1	1	\$14.13
118-0908	8" Complete Stem Assembly: Includes Stem Bottom Assembly	B	1	1	\$14.80
118-0910	10" Complete Stem Assembly: Includes Stem Bottom Assembly	B	1	1	\$15.82
118-0912	12" Complete Stem Assembly: Includes Stem Bottom Assembly	B	1	1	\$16.49
<b>119 SERIES</b>					
119-00	Gray Flange	B	1	25	\$0.96
119-01	Handle Assembly And Screw	B	1	10	\$3.20
119-03	Packing Nut	B	1	10	\$2.66
119-04	Packing	B	1	25	\$0.87
119-07	Cartridge Assembly	B	1	100	\$17.42
119-08	Vacuum Breaker Kit	B	1	6	\$5.11
119-08C	Vacuum Breaker Cap, Chrome-Plated	B	1	6	\$3.76
119-0904	4" Stem, 5-1/2" Total Length	B	1	10	\$5.25
119-0906	6" Stem, 7-1/2" Total Length	B	1	10	\$6.28
119-0908	8" Stem, 9-1/2" Total Length	B	1	10	\$6.86
119-0910	10" Stem, 11-1/2" Total Length	B	1	10	\$8.86
119-0912	12" Stem, 13-1/2" Total Length	B	1	10	\$8.55
119-10	Jam Nut	BI	1	6	\$3.02

Specialties

Appendix

**Vacuum Breaker**

Item Number	Item Description	Pkg Type	Min Qty	Case Qty	Price
<b>LEADED</b>					
117-03	3/4" Female Hose Thread × 3/4" Male Hose Thread	BI	20	240	\$9.07



117-03

**Thermostatic Mixing Valve**

Related Products  
OxBox™ TMV p 190

Item Number	Item Description	Pkg Type	Min Qty	Case Qty	Price
<b>VALVE</b>					
<b>120-TM3F</b>	3/8" Comp. Inlets x 3/8" Comp. Outlets, Capped	BI	1	10	\$114.00
<b>REPAIR KITS</b>					
<b>120-TM3F-1</b>	THERMOSTATIC MIX VLV SCREEN KIT, 2/BG	BI	1	500	\$0.87
120-TM3F-2	THERMOSTATIC MIX VLV PISTON REPAIR KIT, 1/BG	BI	1	300	\$14.65
120-TM3F-3	THERMOSTATIC MIX VLV CHECK VALVE REPAIR KIT, 1/BG	BI	1	500	\$4.39



120-TM3F

Supply

Drainage

Support

Specialties

Appendix



## 1/2" Male Sweat Branch, Manifold

### 1" MSWT × 1" MSWT Trunk

- Do not recirculate back through any manifold branch. Do not modify manifold. Doing so will void warranty
- Male sweat inlet/outlet/branches can be soldered, pressed or push fit onto

Item Number	Item Description	Pkg Type	Min Qty	Case Qty	Price
678-20344	1/2" MSWT, 3 Port	BI	10	10	\$24.98
678-20644	1/2" MSWT, 6 Port	BI	10	10	\$42.83
678-21244	1/2" MSWT, 12 Port	B	10	10	\$78.44

## 1/2" Male Sweat Branch, Manifold

### 1" MSWT × 1" FSWT Trunk

- Male sweat inlet/outlet/branches can be soldered, pressed or push fit onto

Item Number	Item Description	Pkg Type	Min Qty	Case Qty	Price
678-20242	1/2" MSWT, 2 Port	BI	10	10	\$20.34
678-20342	1/2" MSWT, 3 Port	BI	10	10	\$26.29
678-20442	1/2" MSWT, 4 Port	BI	10	10	\$32.24
6784L-11313	1/2" MSWT, 11 Port, 3" O.C.	BI	5	5	\$82.24



## 3/4" Male Sweat Branch, Manifold

### 1-1/4" MSWT × 1-1/4" MSWT Trunk

- Do not recirculate back through any manifold branch. Do not modify manifold. Doing so will void warranty
- Male sweat inlet/outlet/branches can be soldered, pressed or push fit onto

Item Number	Item Description	Pkg Type	Min Qty	Case Qty	Price
6795L-12333	3/4" MSWT, 12 Port, 3" O.C.	BI	1	5	\$260.51

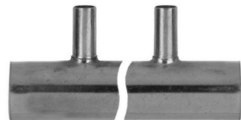

### 3/4" Male Sweat Branch, Manifold

#### 1-1/2" MSWT × 1-1/2" FSWT Trunk

- Do not recirculate back through any manifold branch. Do not modify manifold. Doing so will void warranty
- Male sweat inlet/outlet/branches can be soldered, pressed or push fit onto



Item Number	Item Description	Pkg Type	Min Qty	Case Qty	Price
6796L-12333	3/4" MSWT, 12 Port, 3" O.C.	BI	1	5	\$261.03

### 3/4" Male Sweat Branch, Manifold

#### 2" MSWT × 2" MSWT Trunk

- Male sweat inlet/outlet/branches can be soldered, pressed or push fit onto

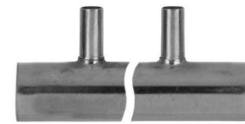

Item Number	Item Description	Pkg Type	Min Qty	Case Qty	Price
6797L-12333	3/4" MSWT, 12 Port, 3" O.C.	BI	1	4	\$261.56

### 3/4" Female Sweat Branch, Manifold

#### 1-1/4" MSWT × 1-1/4" MSWT Trunk

- Do not recirculate back through any manifold branch. Do not modify manifold. Doing so will void warranty
- Male sweat inlet/outlet/branches can be soldered, pressed or push fit onto

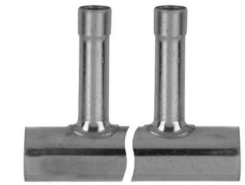

Item Number	Item Description	Pkg Type	Min Qty	Case Qty	Price
67745L-08334	3/4" FSWT, 8 Port, 4" O.C.	BI	1	5	\$169.39

### 1/2" MIP Branch, Manifold

#### 1" MSWT × 1" MSWT Trunk

- Do not recirculate back through any manifold branch. Do not modify manifold. Doing so will void warranty
- NL/DZR
- Male sweat inlet/outlet/branches can be soldered, pressed or push fit onto

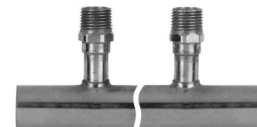

Item Number	Item Description	Pkg Type	Min Qty	Case Qty	Price
675-20344	1/2" MIP, 3 Port	B	10	10	\$46.88
675-20444	1/2" MIP, 4 Port	B	10	10	\$60.13
675-20544	1/2" MIP, 5 Port	B	10	10	\$62.23

Supply

Drainage

Support

Specialties

Appendix



### 1/2" MIP Branch, Manifold

#### 1" MSWT × 1" FSWT Trunk

- Do not recirculate back through any manifold branch. Do not modify manifold. Doing so will void warranty
- NL/DZR
- Male sweat inlet/outlet/branches can be soldered, pressed or push fit onto

Item Number	Item Description	Pkg Type	Min Qty	Case Qty	Price
675-20442	1/2" MIP, 4 Port	B	10	10	\$60.13

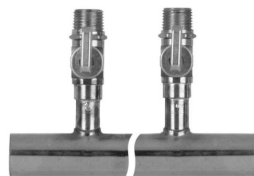

### 1/2" MIP/FSWT Ball Valve Branch, Manifold

#### 1" MSWT × 1" MSWT Trunk

- Do not recirculate back through any manifold branch. Do not modify manifold. Doing so will void warranty
- Male sweat inlet/outlet/branches can be soldered, pressed or push fit onto

Item Number	Item Description	Pkg Type	Min Qty	Case Qty	Price
<b>LEADED</b>					
675-V20244	1/2" MIP/FSWT Ball Valve, 2 Port	BI	1	10	\$63.13
675-V20344	1/2" MIP/FSWT Ball Valve, 3 Port	BI	1	10	\$91.13
675-V20444	1/2" MIP/FSWT Ball Valve, 4 Port	BI	1	10	\$119.13
675-V20544	1/2" MIP/FSWT Ball Valve, 5 Port	BI	1	10	\$146.48



### 1/2" MIP/FSWT Ball Valve Branch, Manifold

#### 1" MSWT × 1" FSWT Trunk

- Do not recirculate back through any manifold branch. Do not modify manifold. Doing so will void warranty
- Male sweat inlet/outlet/branches can be soldered, pressed or push fit onto

Item Number	Item Description	Pkg Type	Min Qty	Case Qty	Price
<b>LEADED</b>					
675-V20342	1/2" MIP/FSWT Ball Valve, 3 Port	BI	1	10	\$92.44
675-V20442	1/2" MIP/FSWT Ball Valve, 4 Port	BI	1	10	\$120.44



### Sweat Shower-Up™ Kit

- For individual product details, see product pages
- NL/DZR

**Related Products**

Shower WallNut™ p 640



693-13155301

Item Number	Item Description	Pkg Type	Min Qty	Case Qty	Price
693-13155301	(1) 608-L2508, (1) 613-87, (2) 632X263, (1) 523-2434, (1) 525-16WLB	BI	12	12	\$70.78
<b>693-13755301</b>	(1) 608-L2508, (1) 613-87, (2) 632WG263, (1) 523-2434, (1) 525-16WLB	BI	1	12	\$82.20

### Sweat Water Heater Connector Kit

- DO NOT use pipe dope on FIP swivel threads
- For individual product details, see product pages
- NL/DZR



694-G21012091

Item Number	Item Description	Pkg Type	Min Qty	Case Qty	Price
<b>694-G21012091</b>	(1) 633-312, (1) 633-G3TM15, (1) 631-G305FP	BI	1	10	\$107.50

Supply

Drainage

Support

Specialties

Appendix



# PDQ™ Push Fit System

PDQ™ Push - Fittings, Adapters & Connectors

PDQ™ Push Preformed Copper & Valves

PDQ™ Push Fit Manifolds

PDQ™ helps contractors get *Plumbing Done Quickly*.

Sioux Chief's PDQ push fit system offers a fast, reliable, tool-free connection solution for CTS copper and CPVC, or SDR9 PEX tubing. PDQ Fittings are made to the ASSE 1061 *Performance Requirements for Push-Fit Fittings*, and can be used in potable water or hydronic heating applications.

**Important Notes About Sioux Chief PDQ Fittings:**

PDQ fittings are not compatible with chrome or nickel-plated stub outs and stub out elbows.

A tube stiffener must be used when installing PEX tube into a PDQ fitting.

Do Not apply heat to PDQ fittings



See complete installation instructions at [www.siouxchief.com](http://www.siouxchief.com)



**642QG2**  
Page 133



**641QG333**  
Page 133



**645QG4**  
Page 134



**600QG406**  
Page 135



**605QG3**  
Page 135



**646QG3**  
Page 135



**633Q03**  
Page 136



**647QG2**  
Page 136



**632QG222M**  
Page 136



**647QG2E3**  
Page 136



**632QG222F**  
Page 136



**603Q2**  
Page 137



**305Q2**  
Page 137



**630Q248**  
Page 138



**630Q248E**  
Page 138



**632Q263X**  
Page 138



**633Q06FP**  
Page 138



**634Q418**  
Page 139



**634Q418FP**  
Page 139



**601Q30V**  
Page 139



**648QG3**  
Page 139



**117Q22**  
Page 139



**119Q210**  
Page 140



**694Q312620**  
Page 140



**672Q0490**  
Page 141

Push Fit Elbow

Item Number	Item Description	Pkg Type	Min Qty	Case Qty	Price
<b>NL/DZR BRASS</b>					
642QG2	1/2" x 1/2"	Cl	12	12	\$14.97
642QG3	3/4" x 3/4"	Cl	12	12	\$19.86
642QG32	3/4" x 1/2"	Cl	6	6	\$19.28
642QG4	1" x 1"	Cl	6	6	\$37.00
642QG43	1" x 3/4"	Cl	6	6	\$34.07
642QG5	1-1/4" x 1-1/4"	Cl	3	3	\$91.77
642QG6	1-1/2" x 1-1/2"	Cl	3	3	\$126.55
642QG7	2" x 2"	Cl	3	3	\$170.94



642QG2



642QG32

Push Fit Tee

Item Number	Item Description	Pkg Type	Min Qty	Case Qty	Price
<b>STANDARD TEE - NL/DZR BRASS</b>					
641QG222	1/2" x 1/2" x 1/2"	Cl	12	12	\$18.92
641QG222F	1/2" Push Fit x 1/2" Push Fit x 1/2" FIP	Cl	6	6	\$24.37
641QG222M	1/2" Push Fit x 1/2" Push Fit x 1/2" MIP	Cl	6	6	\$24.04
641QG333	3/4" x 3/4" x 3/4"	Cl	12	12	\$26.49
641QG333F	3/4" Push Fit x 3/4" Push Fit x 3/4" FIP	Cl	6	6	\$31.57
641QG333M	3/4" Push Fit x 3/4" Push Fit x 3/4" MIP	Cl	6	6	\$30.85
641QG444	1" x 1" x 1"	Cl	6	6	\$44.79
641QG555	1-1/4" x 1-1/4" x 1-1/4"	Cl	3	3	\$133.90
641QG666	1-1/2" x 1-1/2" x 1-1/2"	Cl	3	3	\$192.28
641QG777	2" x 2" x 2"	Cl	3	3	\$249.87
<b>REDUCING TEE - NL/DZR BRASS</b>					
641QG322	3/4" x 1/2" x 1/2"	Cl	12	12	\$25.37
641QG323	3/4" x 1/2" x 3/4"	Cl	6	6	\$26.57
641QG332	3/4" x 3/4" x 1/2"	Cl	6	6	\$25.40
641QG424	1" x 1/2" x 1"	Cl	6	6	\$43.34
641QG443	1" x 1" x 3/4"	Cl	6	6	\$45.75
<b>BULLHEAD TEE - NL/DZR BRASS</b>					
641QG223	1/2" x 1/2" x 3/4"	Cl	6	6	\$25.10
641QG224	1/2" x 1/2" x 1"	Cl	6	6	\$28.74
641QG334	3/4" x 3/4" x 1"	Cl	6	6	\$37.39



641QG222



641QG323



641QG223

Supply

Drainage

Support

Specialties

Appendix



641Q3-3Q2

### Push Fit Transition Tee

- For mechanical connection only - Do Not Solder
- Applying heat or cutting this fitting voids warranty

Item Number	Item Description	Pkg Type	Min Qty	Case Qty	Price
<b>COPPER</b>					
641Q3-3Q2	3/4" Push Fit × 3/4" CTS × 1/2" Push Fit	CI	1	6	\$37.05



645Q2-3

### Push Fit Transition Adapter

- For mechanical connection only - Do Not Solder
- Applying heat or cutting this fitting voids warranty

Item Number	Item Description	Pkg Type	Min Qty	Case Qty	Price
<b>COPPER</b>					
645Q2-3	1/2" Push Fit × 3/4" CTS, 1/Bag	CI	10	10	\$16.15
645Q3-2	3/4" Push Fit × 1/2" CTS, 1/Bag	CI	10	10	\$18.79

### Push Fit Coupling



645QG2



645QG32

Item Number	Item Description	Pkg Type	Min Qty	Case Qty	Price
<b>NL/DZR BRASS</b>					
645QG2	1/2" × 1/2"	CI	12	12	\$13.57
645QG3	3/4" × 3/4"	CI	12	12	\$17.17
645QG32	3/4" × 1/2"	CI	6	6	\$16.78
645QG4	1" × 1"	CI	6	6	\$36.25
645QG43	1" × 3/4"	CI	6	6	\$41.79
645QG5	1-1/4" × 3/4"	CI	3	3	\$94.86
645QG54	1-1/4" × 1"	CI	3	3	\$87.59
645QG6	1-1/2" × 1-1/2"	CI	3	3	\$131.82
645QG65	1-1/2" × 1-1/4"	CI	3	3	\$121.63
645QG7	2" × 2"	CI	3	3	\$192.60
645QG76	2" × 1-1/2"	CI	3	3	\$182.41

**Push Fit Slip Coupling**

Item Number	Item Description	Pkg Type	Min Qty	Case Qty	Price
<b>COPPER</b>					
600Q206	1/2" Slip Coupling, Copper	Bl	6	6	\$20.44
600Q306	3/4" Slip Coupling, Copper	Bl	6	6	\$25.07
<b>NL/DZR BRASS</b>					
600QG406	1" Slip Coupling, No-Lead Brass	Bl	6	6	\$53.52



600Q306



600QG406

**Push Fit Cap**

Item Number	Item Description	Pkg Type	Min Qty	Case Qty	Price
<b>NL/DZR BRASS</b>					
605QG2	1/2" Push Fit	Cl	12	12	\$10.38
605QG3	3/4" Push Fit	Cl	6	6	\$12.99
605QG4	1" Push Fit	Cl	6	6	\$28.29
605QG5	1-1/4" Push Fit	Cl	3	3	\$60.27
605QG6	1-1/2" Push Fit	Cl	3	3	\$72.54
605QG7	2" Push Fit	Cl	3	3	\$90.09



605QG3

**Push Fit Straight Adapter**

**MIP**

Item Number	Item Description	Pkg Type	Min Qty	Case Qty	Price
<b>NL/DZR BRASS</b>					
646QG2	1/2" Push Fit x 1/2" MIP	Cl	12	12	\$11.14
646QG3	3/4" Push Fit x 3/4" MIP	Cl	12	12	\$13.64
646QG32	1/2" Push Fit x 3/4" MIP	Cl	6	6	\$13.54
646QG34	1" Push Fit x 3/4" MIP	Cl	6	6	\$23.85
646QG4	1" Push Fit x 1" MIP	Cl	6	6	\$27.92
646QG5	1-1/4" Push Fit x 1-1/4" MIP	Cl	3	3	\$76.82
646QG6	1-1/2" Push Fit x 1-1/2" MIP	Cl	3	3	\$110.20
646QG7	2" Push Fit x 2" MIP	Cl	3	3	\$132.68



646QG2

- Supply
- Drainage
- Support
- Specialties
- Appendix

Supply

Drainage

Support

Specialties

Appendix



633Q03

### Push Fit Straight Adapter

#### FIP Swivel Adapter

· DO NOT use pipe dope on FIP swivel threads

Item Number	Item Description	Pkg Type	Min Qty	Case Qty	Price
<b>NL/DZR</b>					
633Q03	3/4" Push Fit × 3/4" FIP Swivel, 2"	BI	12	12	\$17.44
637Q2	1/2" Push Fit × 1/2" FIP Swivel	BI	12	12	\$10.10



647QG2

### Push Fit Straight Adapter

#### FIP

Item Number	Item Description	Pkg Type	Min Qty	Case Qty	Price
<b>NL/DZR BRASS</b>					
647QG2	1/2" Push Fit × 1/2" FIP	CI	12	12	\$11.80
647QG3	3/4" Push Fit × 3/4" FIP	CI	12	12	\$15.06
647QG32	1/2" Push Fit × 3/4" FIP	CI	6	6	\$14.97
647QG34	1" Push Fit × 3/4" FIP	CI	6	6	\$25.46
647QG4	1" Push Fit × 1" FIP	CI	12	12	\$28.88
647QG43	3/4" Push Fit × 1" FIP	CI	6	6	\$27.29
647QG5	1-1/4" Push Fit × 1-1/4" FIP	CI	3	3	\$83.20
647QG6	1-1/2" Push Fit × 1-1/2" FIP	CI	3	3	\$122.24
647QG7	2" Push Fit × 2" FIP	CI	3	3	\$146.75



632QG222M

### Push Fit Elbow Adapter

#### MIP

Item Number	Item Description	Pkg Type	Min Qty	Case Qty	Price
<b>NL/DZR BRASS</b>					
632QG222M	1/2" Push Fit × 1/2" MIP	BI	6	6	\$15.09



632QG222F

### Push Fit Elbow Adapter

#### FIP

Item Number	Item Description	Pkg Type	Min Qty	Case Qty	Price
<b>NL/DZR BRASS</b>					
632QG222F	1/2" Push Fit × 1/2" FIP	BI	6	6	\$15.31
647QG2E3	1/2" Push Fit × 1/2" FIP Drop-Ear	CI	6	6	\$16.10



**Poly Tube Stiffener**

Item Number	Item Description	Pkg Type	Min Qty	Case Qty	Price
603Q2	1/2", 6/Bag	Cl	15	15	\$4.40
603Q3	3/4", 6/Bag	Cl	15	15	\$7.26
603Q4	1", 6/Bag	Cl	15	15	\$9.72



603Q2

**Stainless Steel Tube Stiffener**

Item Number	Item Description	Pkg Type	Min Qty	Case Qty	Price
280-A266537	1/2"	B	10	2500	\$2.35
280-A266607	3/4"	B	50	1000	\$8.85
280-A266617	1"	B	50	1000	\$10.06
280-A266627	1-1/4"	B	25	25	\$13.73
280-A266637	1-1/2"	B	25	25	\$14.67



280-A266537

**Push Fit Disconnect Tools**

Item Number	Item Description	Pkg Type	Min Qty	Case Qty	Price
305Q2	1/2", 1/Bag	Cl	24	24	\$2.41
305Q23PK1	1/2" & 3/4", 1 Pair/Bag	Bl	12	12	\$4.80
305Q3	3/4", 1/Bag	Cl	24	24	\$2.41
305Q4	1", 1/Bag	Cl	12	12	\$2.70
305Q4PK1	1", 1/Bag	Bl	5	400	\$2.95
305Q5	1-1/4", 1/Bag	Bl	5	5	\$26.60
305Q6	1-1/2", 1/Bag	Bl	1	1	\$28.33
305Q7	2", 1/Bag	Bl	1	1	\$28.33



305Q2

Supply

Drainage

Support

Specialties

Appendix



630Q248

### Push Fit Stub Out Elbow

- Do not allow PDQ portion of fitting to be heated

Item Number	Item Description	Pkg Type	Min Qty	Case Qty	Price
630Q248	1/2" Push Fit, 4" × 8"	BI	20	20	\$16.79
630Q368	3/4" Push Fit, 6" × 8"	BI	10	10	\$19.27



630Q248E

### Push Fit Stub Out Elbow

#### Stub out With Square O Strap

- Do not allow PDQ portion of fitting to be heated

Item Number	Item Description	Pkg Type	Min Qty	Case Qty	Price
630Q248E	1/2" Push Fit, 4" × 8", w/ Strap	BI	10	10	\$17.82
630Q4910E	1" Push Fit, 9" × 10", w/ Strap	BI	10	10	\$37.19



632Q263Y

### Push Fit Tub/Shower Connector

- DO NOT use pipe dope on FIP swivel threads
- NL/DZR

Item Number	Item Description	Pkg Type	Min Qty	Case Qty	Price
632Q263	1/2" Push Fit, 6" × 3"	BI	20	20	\$15.08
632Q263X	1/2" Push Fit × 1/2" MIP Swivel, 6" × 3"	BI	20	20	\$21.97
632Q263Y	1/2" Push Fit × 1/2" FIP Swivel, 6" × 3"	BI	20	20	\$21.28



633Q18

### Push-Fit Water Heater Connector

#### FIP Swivel Straight

- DO NOT use pipe dope on FIP swivel threads
- NL/DZR

Item Number	Item Description	Pkg Type	Min Qty	Case Qty	Price
<b>STANDARD</b>					
633Q18	3/4" Push Fit × 3/4" FIP Swivel, 18"	BI	10	10	\$33.00
<b>VALVED, FULL PORT</b>					
633Q06FP	3/4" Push Fit × 3/4" FIP Swivel, 6"	BI	10	10	\$56.33
633Q18FP	3/4" Push Fit × 3/4" FIP Swivel, 18"	BI	10	10	\$68.00



633Q06FP

## Push-Fit Water Heater Connector

### Straight Flexible Copper FIP Swivel

- DO NOT use pipe dope on FIP swivel threads
- Do not twist or kink flexible connector
- NL/DZR

Item Number	Item Description	Pkg Type	Min Qty	Case Qty	Price
<b>STANDARD</b>					
634Q418	3/4" Push Fit × 3/4" FIP Swivel, 18"	B	12	12	\$27.19
<b>VALVED, FULL PORT</b>					
634Q418FP	3/4" Push Fit × 3/4" FIP Swivel, 18"	B	10	10	\$60.89



## Add-A-Line™

### Push-Fit Tee

- Applying heat or cutting this fitting voids warranty
- For mechanical connection only - Do Not Solder
- DO NOT use pipe dope on comp. threads
- NL/DZR

Item Number	Item Description	Pkg Type	Min Qty	Case Qty	Price
601Q20V	1/2" Push Fit × 1/4" OD Comp	Bl	6	6	\$40.25
601Q30V	3/4" Push Fit × 1/4" OD Comp	Bl	6	6	\$52.21



## Push Fit Brass Ball Valve

- NL/DZR Brass

Item Number	Item Description	Pkg Type	Min Qty	Case Qty	Price
<b>FULL PORT</b>					
648QG2	1/2" Push Fit	Cl	12	12	\$33.43
648QG3	3/4" Push Fit	Cl	12	12	\$41.28
648QG4	1" Push Fit	Cl	6	6	\$60.63



## Push Fit Sillcock

Item Number	Item Description	Pkg Type	Min Qty	Case Qty	Price
<b>LEADED</b>					
117Q22	1/2" Push Fit	Bl	6	6	\$23.72



Supply

Drainage

Support

Specialties

Appendix

Supply

Drainage

Support

Specialties

Appendix



119Q208

### Push Fit Frost-Proof Sillcock

**Related Products**

Frost-Proof Sillcock Replacement Parts p 124

Item Number	Item Description	Pkg Type	Min Qty	Case Qty	Price
<b>1/4 TURN - LEADED</b>					
119Q208	1/2" Push Fit, 8"	B	5	5	\$80.58
119Q210	1/2" Push Fit, 10"	B	5	5	\$84.72



694Q312620

### Push Fit Water Heater Connector Kit

- DO NOT use pipe dope on FIP swivel threads
- NL/DZR

Item Number	Item Description	Pkg Type	Min Qty	Case Qty	Price
694Q312620	(1) 633Q03, (1) 633Q06FP	BI	10	10	\$75.77
694Q464120	(1) 634Q418, (1) 634Q418FP	BI	10	10	\$90.08

## 1/2" Push Fit Branch, Manifold

### 3/4" Push Fit × Spun Closed Trunk

- Do not recirculate back through any manifold branch. Do not modify manifold. Doing so will void warranty
- NL/DZR



Item Number	Item Description	Pkg Type	Min Qty	Case Qty	Price
672Q0490	1/2" Push Fit, 4 Port	BI	10	10	\$75.58
672Q0590	1/2" Push Fit, 5 Port	BI	10	10	\$92.33
672Q0690	1/2" Push Fit, 6 Port	BI	10	10	\$109.08

## 1/2" Push Fit Branch, Manifold

### 3/4" Push Fit × 3/4" Push Fit Trunk

- Do not recirculate back through any manifold branch. Do not modify manifold. Doing so will void warranty
- NL/DZR



Item Number	Item Description	Pkg Type	Min Qty	Case Qty	Price
672Q0499	1/2" Push Fit, 4 Port	BI	10	10	\$91.33
672Q0599	1/2" Push Fit, 5 Port	BI	10	10	\$108.08
672Q0699	1/2" Push Fit, 6 Port	BI	10	10	\$124.83

Supply

Drainage

Support

Specialties

Appendix



# Supply Accessories

## Foam Pipe/Tube Insulation

Using foam pipe/tube insulation reduces noise, condensation, and conserves energy by reducing heat-loss. Sioux Chief's closed-cell foam insulation is made in the USA and provides the ideal combination of flexibility and rigidity for easier installation.







## Foam Pipe/Tube Insulation

### Self-Seal Seam - Black

All item numbers come in 6' lengths



663-05838SS

Item Number	Item Description	Pkg Type	Min Qty	Case Qty	Price
<b>3/8" WALL</b>					
663-03838SS	3/8" ID, 1/4" CTS, 600 Ft/Box	B	1	1	\$229.79
663-05838SS	5/8" ID, 1/2" CTS, 408 Ft/Box	B	1	1	\$199.82
663-07838SS	7/8" ID, 3/4" CTS, 300 Ft/Box	B	1	1	\$155.61
663-11838SS	1-1/8" ID, 1" CTS, 240 Ft/Box	B	1	1	\$148.62
663-13838SS	1-3/8" ID, 1-1/4" CTS, 192 Ft/Box	B	1	1	\$166.08
663-15838SS	1-5/8" ID, 1-1/2" CTS, 132 Ft/Box	B	1	1	\$156.16
663-20038SS	2" ID, 1-1/2" IPS, 126 Ft/Box	B	1	1	\$164.29
663-21838SS	2-1/8" ID, 2" CTS, 90 Ft/Box	B	1	1	\$139.24
663-25838SS	2-5/8" ID, 2-1/2" CTS, 72 Ft/Box	B	1	1	\$142.62
663-31838SS	3-1/8" ID, 3" CTS, 54 Ft/Box	B	1	1	\$142.30
<b>1/2" WALL</b>					
663-01212SS	1/2" ID, 3/8" CTS, 360 Ft/Box	B	1	1	\$206.46
663-03412SS	3/4" ID, 5/8" CTS, 270 Ft/Box	B	1	1	\$198.86
663-05812SS	5/8" ID, 1/2" CTS, 306 Ft/Box	B	1	1	\$198.86
663-07812SS	7/8" ID, 3/4" CTS, 240 Ft/Box	B	1	1	\$174.79
663-11812SS	1-1/8" ID, 1" CTS, 180 Ft/Box	B	1	1	\$179.86
663-13812SS	1-3/8" ID, 1-1/4" CTS, 150 Ft/Box	B	1	1	\$163.39
663-15812SS	1-5/8" ID, 1-1/2" CTS, 120 Ft/Box	B	1	1	\$153.28
663-21812SS	2-1/8" ID, 2" CTS, 84 Ft/Box	B	1	1	\$140.60
663-23812SS	2-3/8" ID, 2" IPS, 66 Ft/Box	B	1	1	\$133.01
663-25812SS	2-5/8" ID, 2-1/2" CTS, 60 Ft/Box	B	1	1	\$133.01
663-31212SS	3-1/2" ID, 3" IPS, 42 Ft/Box	B	1	1	\$192.69
<b>3/4" WALL</b>					
663-05834SS	5/8" ID, 1/2" CTS, 180 Ft/Box	B	1	1	\$228.64
663-07834SS	7/8" ID, 3/4" CTS, 156 Ft/Box	B	1	1	\$228.71
663-11834SS	1-1/8" ID, 1" CTS, 102 Ft/Box	B	1	1	\$221.73
663-13834SS	1-3/8" ID, 1-1/4" CTS, 90 Ft/Box	B	1	1	\$205.17
663-15834SS	1-5/8" ID, 1-1/2" CTS, 84 Ft/Box	B	1	1	\$240.18
663-21834SS	2-1/8" ID, 2" CTS, 54 Ft/Box	B	1	1	\$198.38
663-23834SS	2-3/8" ID, 2" IPS, 54 Ft/Box	B	1	1	\$228.54
<b>1" WALL</b>					
663-05810SS	5/8" ID, 1/2" CTS, 108 Ft/Box	B	1	1	\$181.86
663-07810SS	7/8" ID, 3/4" CTS, 90 Ft/Box	B	1	1	\$191.26
663-11810SS	1-1/8" ID, 1" CTS, 90 Ft/Box	B	1	1	\$196.33
663-13810SS	1-3/8" ID, 1-1/4" CTS, 72 Ft/Box	B	1	1	\$222.42
663-15810SS	1-5/8" ID, 1-1/2" CTS, 60 Ft/Box	B	1	1	\$156.92
663-21810SS	2-1/8" ID, 2" CTS, 48 Ft/Box	B	1	1	\$241.55
663-23810SS	2-3/8" ID, 2" IPS, 42 Ft/Box	B	1	1	\$277.04
663-25810SS	2-5/8" ID, 2-1/2" CTS, 36 Ft/Box	B	1	1	\$268.31

Supply

Drainage

Support

Specialties

Appendix

## Foam Pipe/Tube Insulation

### Half-Slit - Black

· All item numbers come in 6' lengths

Item Number	Item Description	Pkg Type	Min Qty	Case Qty	Price
<b>3/8" WALL</b>					
663-03838HS	3/8" ID, 1/4" CTS, 600 Ft/Box	B	1	1	\$210.51
663-05838HS	5/8" ID, 1/2" CTS, 408 Ft/Box	B	1	1	\$159.97
663-07838HS	7/8" ID, 3/4" CTS, 300 Ft/Box	B	1	1	\$126.91
663-11838HS	1-1/8" ID, 1" CTS, 240 Ft/Box	B	1	1	\$116.33
663-13838HS	1-3/8" ID, 1-1/4" CTS, 192 Ft/Box	B	1	1	\$115.46
663-15838HS	1-5/8" ID, 1-1/2" CTS, 132 Ft/Box	B	1	1	\$115.13
663-20038HS	2" ID, 1-1/2" IPS, 126 Ft/Box	B	1	1	\$127.89
663-21838HS	2-1/8" ID, 2" CTS, 90 Ft/Box	B	1	1	\$107.74
663-25838HS	2-5/8" ID, 2-1/2" CTS, 72 Ft/Box	B	1	1	\$104.99
663-31838HS	3-1/8" ID, 3" CTS, 54 Ft/Box	B	1	1	\$133.12
<b>1/2" WALL</b>					
663-01212HS	1/2" ID, 3/8" CTS, 360 Ft/Box	B	1	1	\$149.51
663-03412HS	3/4" ID, 5/8" CTS, 270 Ft/Box	B	1	1	\$133.83
663-05812HS	5/8" ID, 1/2" CTS, 306 Ft/Box	B	1	1	\$136.81
663-07812HS	7/8" ID, 3/4" CTS, 240 Ft/Box	B	1	1	\$123.97
663-11812HS	1-1/8" ID, 1" CTS, 180 Ft/Box	B	1	1	\$123.97
663-13812HS	1-3/8" ID, 1-1/4" CTS, 150 Ft/Box	B	1	1	\$128.96
663-15812HS	1-5/8" ID, 1-1/2" CTS, 120 Ft/Box	B	1	1	\$134.12
663-21812HS	2-1/8" ID, 2" CTS, 84 Ft/Box	B	1	1	\$123.93
663-23812HS	2-3/8" ID, 2" IPS, 66 Ft/Box	B	1	1	\$127.45
663-25812HS	2-5/8" ID, 2-1/2" CTS, 60 Ft/Box	B	1	1	\$114.19
<b>3/4" WALL</b>					
663-05834HS	5/8" ID, 1/2" CTS, 180 Ft/Box	B	1	1	\$135.46
663-07834HS	7/8" ID, 3/4" CTS, 156 Ft/Box	B	1	1	\$140.57
663-11834HS	1-1/8" ID, 1" CTS, 102 Ft/Box	B	1	1	\$189.35
663-13834HS	1-3/8" ID, 1-1/4" CTS, 90 Ft/Box	B	1	1	\$170.69
663-15834HS	1-5/8" ID, 1-1/2" CTS, 84 Ft/Box	B	1	1	\$186.74
663-21834HS	2-1/8" ID, 2" CTS, 54 Ft/Box	B	1	1	\$152.60
663-23834HS	2-3/8" ID, 2" IPS, 54 Ft/Box	B	1	1	\$213.76
663-25834HS	2-5/8" ID, 2-1/2" CTS, 48 Ft/Box	B	1	1	\$219.68
<b>1" WALL</b>					
663-05810HS	5/8" ID, 1/2" CTS, 108 Ft/Box	B	1	1	\$165.94
663-07810HS	7/8" ID, 3/4" CTS, 90 Ft/Box	B	1	1	\$172.65
663-11810HS	1-1/8" ID, 1" CTS, 90 Ft/Box	B	1	1	\$151.98
663-13810HS	1-3/8" ID, 1-1/4" CTS, 72 Ft/Box	B	1	1	\$186.43
663-15810HS	1-5/8" ID, 1-1/2" CTS, 60 Ft/Box	B	1	1	\$156.03
663-21810HS	2-1/8" ID, 2" CTS, 48 Ft/Box	B	1	1	\$152.72
663-23810HS	2-3/8" ID, 2" IPS, 42 Ft/Box	B	1	1	\$174.48
663-25810HS	2-5/8" ID, 2-1/2" CTS, 36 Ft/Box	B	1	1	\$165.86

Supply

Drainage

Support

Specialties

Appendix



663-07838HS



663-05812HS



663-13834HS



663-07810HS

## Foam Pipe/Tube Insulation

### White - 1/2" Wall

· All item numbers come in 6' lengths



663-07812WSS

Item Number	Item Description	Pkg Type	Min Qty	Case Qty	Price
<b>SELF-SEAL</b>					
663-13812WSS	1-3/8" ID, 1-1/4" CTS, 150 Ft/Box	B	1	1	\$153.51
663-15812WSS	1-5/8" ID, 1-1/2" CTS, 120 Ft/Box	B	1	1	\$144.80
663-25812WSS	2-5/8" ID, 2-1/2" CTS, 60 Ft/Box	B	1	1	\$124.96
663-31812WSS	3-1/8" ID, 3" CTS, 48 Ft/Box	B	1	1	\$146.72
663-41212WSS	4-1/2" ID, 4" IPS, 24 Ft/Box	B	1	1	\$131.58

Supply

Drainage

Support

Specialties

Appendix



# **Arresters & Trap Primers**

**Water Hammer Arresters**

**Trap Primers**

# Arresters & Trap Primers

## Water Hammer Arresters

Sioux Chief water hammer arresters are ASSE certified to the *ANSI/ASSE 1010 Performance Requirements for Water Hammer Arresters*. AA size arrester models are IAPMO listed to cUPC and Canadian codes and standards.

Sioux Chief arresters may be installed at any angle, are approved for installation with no access panels required, and are compatible with Press-Fitting and Push-Fitting systems.

## Trap Primers

Sioux Chief mechanical trap primer valves are IAPMO listed to cUPC and ASSE certified to the *ANSI/ASSE 1018 Performance Requirements for Trap Seal Primer Valves – Potable Water Supplied*.

Gravity and Electronic trap primers are IAPMO listed to cUPC and ASSE certified to the *ANSI/ASSE 1044 Performance Requirements for Trap Seal Primer – Drainage Types and Electric Design Types*.

# Water Hammer Arresters

Sioux Chief has been an industry leader in water hammer arrester science and solutions for decades. Our arresters are continuously and rigorously tested. The simple but durable piston design provides the longest performance life of any arrester on the market

All arresters are made in the USA from copper, brass, and stainless steel materials.





**660-WG2B**  
Page 153



**660-X2B**  
Page 153



**660-HB**  
Page 153



**660-TS**  
Page 153



**660-TSWG8**  
Page 154



**660-GTX2B**  
Page 154



**660-GTC1B**  
Page 154



**660-GTR1B**  
Page 155



**652-A**  
Page 155



**652-AS**  
Page 155



**653-BC**  
Page 156



**652-AX**  
Page 156



**652-AWG**  
Page 156



**658-2004**  
Page 156



**658S2002**  
Page 157



**652-AD**  
Page 157



**695-01**  
Page 161



**695-Y52**  
Page 161



**695-D432**  
Page 161



**200-092**  
Page 162



**695-ES05**  
Page 162



**695-ER10**  
Page 163



**695-ES01**  
Page 163



**MiniRester™**

**Straight**

· For any residential single-fixture application

Item Number	Item Description	Pkg Type	Min Qty	Case Qty	Price
660-G2	1/2" MIP, Clamshell	Cl	6	6	\$18.02
660-G2B	1/2" MIP	B	50	50	\$16.16
660-GVPX2B	1/2" F3347 PEX Press	B	50	50	\$20.88
660-Q2	1/2" PDQ Push-Fit, Clamshell	Cl	1	6	\$21.76
660-Q2B	1/2" PDQ Push-Fit	B	50	50	\$20.07
660-S	1/2" MSWT, Clamshell	Cl	6	6	\$17.60
660-SB	1/2" MSWT	B	50	50	\$15.74
660-V82B	1/2" CPVC Male	B	50	50	\$15.44
660-WG2B	1/2" F1960 PEX	B	50	50	\$19.44
660-X2B	1/2" F1807 PEX	B	50	50	\$16.69



660-G2B



660-SB

**MiniRester™**

**Laundry Hose Tee/Toilet Fill Valve Tee**

· DO NOT use pipe dope on FIP swivel threads

Item Number	Item Description	Pkg Type	Min Qty	Case Qty	Price
660-H	3/4" Female Swivel Hose Thread × 3/4" Male Hose Thread, Clamshell	Bl	6	6	\$25.45
660-HB	3/4" Female Swivel Hose Thread × 3/4" Male Hose Thread	B	25	25	\$23.46
660-HPK2	3/4" Female Swivel Hose Thread × 3/4" Male Hose Thread, 2/Bag	Bl	20	20	\$50.90
660-TK	Female Swivel Ballcock Nut × Male Ballcock Thread, Clamshell	Cl	6	6	\$32.43
660-TKB	Female Swivel Ballcock Nut × Male Ballcock Thread	B	25	25	\$29.53



660-HB

**MiniRester™**

**Tub Shower / Stub Out Tee**

**Related Products**

3-Valve Kitchen Supply Box p 195

Item Number	Item Description	Pkg Type	Min Qty	Case Qty	Price
<b>TUB SHOWER VALVE TEE</b>					
660-TS	1/2" FSWT × 1/2" MSWT	B	25	25	\$23.77
660-TSWG	1/2" F1960 PEX × 1/2" MSWT	B	25	25	\$30.93
660-TSX	1/2" F1807 PEX × 1/2" MSWT	B	25	25	\$29.64



660-TSWG



660-TSWG8

### MiniRester™ (Cont)

#### Tub Shower / Stub Out Tee

Item Number	Item Description	Pkg Type	Min Qty	Case Qty	Price
<b>STUB OUT TEE</b>					
660-TS8	1/2" FSWT × 1/2" × 8" Stub Out	B	25	25	\$28.72
660-TS88	1/2" FSWT × Double 1/2" × 8" Stub Out	B	25	25	\$34.27
660-TSWG8	1/2" F1960 w/ 1/2" CTS Stub Out, 8"	B	25	25	\$38.62
660-TSX88	1/2" F1807 PEX × Double 1/2" × 8" Stub Out	B	25	25	\$38.28

### MiniRester™

#### PEX Tee

- For any residential single-fixture application with PEX tube

Item Number	Item Description	Pkg Type	Min Qty	Case Qty	Price
<b>F1807 PEX</b>					
660-GTX2	1/2" F1807, Clamshell	CI	6	6	\$26.87
660-GTX2B	1/2" F1807	B	25	25	\$25.00
<b>F1960 PEX</b>					
660-GTW2B	1/2" F1960	B	25	25	\$27.72



660-GTX2B



660-GTW2B

### MiniRester™

#### Compression Tee

- For any residential single-fixture application
- DO NOT use pipe dope on comp. threads

Item Number	Item Description	Pkg Type	Min Qty	Case Qty	Price
660-GTC0	1/4" O.D Comp., Clamshell	CI	6	6	\$31.13
660-GTC0B	1/4" O.D Comp.	B	25	25	\$29.58
660-GTC1	3/8" O.D. Comp., Clamshell	CI	6	6	\$29.58
660-GTC1B	3/8" O.D. Comp.	B	25	25	\$29.58



660-GTC0

**MiniRester™**

**Female Compression Tee**

- Installs directly to supply stops
- DO NOT use pipe dope on comp. threads

Item Number	Item Description	Pkg Type	Min Qty	Case Qty	Price
660-GTR	5/8" O.D. Female Comp. × 5/8" O.D. Comp., Clamshell	Cl	6	6	\$31.72
660-GTRO	1/4" O.D. Female Comp. × 1/4" O.D. Comp., Clamshell	Cl	6	6	\$31.13
660-GTROB	1/4" O.D. Female Comp. × 1/4" O.D. Comp.	B	25	25	\$29.58
660-GTR1	3/8" O.D. Female Comp. × 3/8" O.D. Comp., Clamshell	Cl	6	6	\$31.13
660-GTR1B	3/8" O.D. Female Comp. × 3/8" O.D. Comp.	B	25	25	\$29.58
660-GTRB	5/8" O.D. Female Comp. × 5/8" O.D. Comp.	B	25	25	\$30.20



660-GTR

**HydraRester™**

**MIP**

Item Number	Item Description	Pkg Type	Min Qty	Case Qty	Price
652-A	1/2", Type A, Fixture Units; 1-11	B	1	16	\$22.65
653-B	3/4", Type B, Fixture Units; 12-32	B	1	16	\$26.50
654-C	1", Type C, Fixture Units; 33-60	B	1	16	\$67.07
655-D	1", Type D, Fixture Units; 61-113	B	1	4	\$88.38
656-E	1", Type E, Fixture Units; 114-154	B	1	4	\$116.88
657-F	1", Type F, Fixture Units; 155-330	B	1	4	\$175.47



652-A

**HydraRester™**

**Sweat/Press-Fit**

- Do not overheat. Do not braze.

Item Number	Item Description	Pkg Type	Min Qty	Case Qty	Price
652-AS	1/2", Type A, Fixture Units; 1-11	B	1	16	\$23.30
653-BS	3/4", Type B, Fixture Units; 12-32	B	1	16	\$26.96
654-CS	1", Type C, Fixture Units; 33-60	B	1	16	\$66.55
655-DS	1", Type D, Fixture Units; 61-113	B	1	4	\$88.38
656-ES	1", Type E, Fixture Units; 114-154	B	1	4	\$116.88
657-FS	1", Type F, Fixture Units; 155-330	B	1	4	\$175.47



653-BS

Supply

Drainage

Support

Specialties

Appendix



652-AC



652-AX



652-AWG



658-2004

### HydraRester™

#### CPVC

Item Number	Item Description	Pkg Type	Min Qty	Case Qty	Price
652-AC	1/2", Type A, Fixture Units; 1-11	B	1	16	\$25.64
653-BC	3/4", Type B, Fixture Units; 12-32	B	1	16	\$33.40
654-CC	1", Type C, Fixture Units; 33-60	B	1	16	\$77.58

### HydraRester™

#### PEX

Item Number	Item Description	Pkg Type	Min Qty	Case Qty	Price
<b>F1807 PEX</b>					
652-AX	1/2" F1807, Type A, Fixture Units; 1-11	B	1	16	\$24.87
653-BX	3/4" F1807, Type B, Fixture Units; 12-32	B	1	16	\$28.71
654-CX	1" F1807, Type C, Fixture Units; 33-60	B	1	16	\$67.07
<b>F1960 PEX</b>					
652-AWG	1/2" F1960, Type A, Fixture Units; 1-11	B	1	16	\$27.42
653-BWG	3/4" F1960, Type B, Fixture Units; 12-32	B	1	16	\$36.93
654-CWG	1" F1960, Type C, Fixture Units; 33-60	B	1	16	\$78.79

### MegaRester™

#### Copper

· For industrial Applications. Contact Sioux Chief for custom sizing

Item Number	Item Description	Pkg Type	Min Qty	Case Qty	Price
658-1503	3" MIP, 150 Cu. In.	B	1	1	\$1,559.37
658-2002	2" MIP, 200 Cu. In.	B	1	1	\$1,634.25
658-2004	4" MIP, 200 Cu. In.	B	1	1	\$1,634.21
658-4004	4" MIP, 400 Cu. In.	B	1	1	\$2,107.91
658-4004F2	4" Class 150 Flange, 400 Cu. In.	B	1	1	\$2,195.23

**MegaRester™**

**Stainless Steel**

· For industrial Applications. Contact Sioux Chief for custom sizing

Item Number	Item Description	Pkg Type	Min Qty	Case Qty	Price
658S2002	2" MIP, 200 Cu. In.	B	1	1	\$3,679.79
658S2004F2	4" Class 150 Flange, 200 Cu. In.	B	1	1	\$4,353.04
658S4004F2	4" Class 150 Flange, 400 Cu. In.	B	1	1	\$5,300.98

**VacuRester™**

**MIP**

· For use where the piping system is subject to cavitation on the non-pressure side of a quick closing valve

Item Number	Item Description	Pkg Type	Min Qty	Case Qty	Price
652-AD	1/2" MIP	B	1	16	\$26.90
657-FD	1" MIP	B	1	4	\$177.97



658S2004F2



652-FD

Supply

Drainage

Support

Specialties

Appendix



# Trap Primers

**Mechanical Primers**

**Splitters**

**Priming Drain Adapters**

**Tailpiece Primers**

**Electronic Primers**



Sioux Chief offers a wide variety of ASSE listed trap primers – mechanical, gravity, and electronic, as well as distributors and other accessories.

All Sioux Chief Trap Primers are ASSE Certified. Mechanical Primers are certified to the ASSE 1018 Standard. Electronic and Tailpiece Primers are Certified to the ASSE 1044 Standard.





**PrimePerfect™**

**Mechanical Trap Primer Valve**

- DO NOT use thread sealant compound
- For use in accessible locations only



695-01

Item Number	Item Description	Pkg Type	Min Qty	Case Qty	Price
695-01	1/2" FIP x 1/2" MIP	BI	1	24	\$87.03

**Splitter**

**Wye Splitter**

- DO NOT use pipe dope on FIP swivel threads



695-Y52

Item Number	Item Description	Pkg Type	Min Qty	Case Qty	Price
695-Y52	Two 1/2" MIP Branches	BI	1	10	\$49.78

**Splitter**

**Distributor**

- DO NOT use pipe dope on FIP swivel threads



695-D432

Item Number	Item Description	Pkg Type	Min Qty	Case Qty	Price
695-D20	Two 1/4" MSWT Branches	BI	1	16	\$29.04
695-D30	Three 1/4" MSWT Branches	BI	1	16	\$31.60
695-D40	Four 1/4" MSWT Branches	BI	1	16	\$34.81
695-D432	Two 1/4" MSWT Branches, Two Spun-Closed Branches	BI	1	16	\$34.81
695-D4325	Two 1/2" FSWT Branches, Two Spun-Closed Branches	BI	1	16	\$34.81
695-D432F	Four 1/2" FIP Branches w/ Two Plugs	BI	1	10	\$57.83

Supply

Drainage

Support

Specialties

Appendix



695-3A



695-3P



861-TA23



200-092



695-ES05

### Trap Primer Adapter

#### 1/2" FIP Port

Item Number	Item Description	Pkg Type	Min Qty	Case Qty	Price
<b>ABS - SCH. 40 HUB</b>					
695-2A	2" ABS Hub Adapter w/ 1/2" FIP Port	BI	1	10	\$18.80
695-3A	3" ABS Hub Adapter w/ 1/2" FIP Port	B	1	10	\$21.32
695-4A	4" ABS Hub Adapter w/ 1/2" FIP Port	B	1	10	\$25.07
<b>PVC - SCH. 40 HUB</b>					
695-2P	2" PVC Hub Adapter w/ 1/2" FIP Port	BI	1	10	\$18.80
695-3P	3" PVC Hub Adapter w/ 1/2" FIP Port	BI	1	10	\$21.32
695-4P	4" PVC Hub Adapter w/ 1/2" FIP Port	BI	1	10	\$25.07
<b>CAST IRON NO-HUB</b>					
861-TA22	2" No-Hub - 1/2" FIP	B	1	1	\$213.00
861-TA23	3" No-Hub - 1/2" FIP	B	1	1	\$213.00
861-TA24	4" No-Hub - 1/2" FIP	B	1	1	\$213.00

### Trap-Ease™

#### Trap Primer Tailpiece

Item Number	Item Description	Pkg Type	Min Qty	Case Qty	Price
200-090	1-1/2" × 8" Direct Connect, Unfinished	B	25	25	\$21.54
200-092	1-1/2" × 8" Direct Connect, Chrome	B	25	25	\$25.20
206-096	1-1/4" × 6" Slip-Joint Connect, Chrome	B	25	25	\$31.21
213-090	1-1/4" × 6" Fine Thread, Unfinished	B	25	25	\$22.63
213-092	1-1/4" × 6" Fine Thread, Chrome	B	25	25	\$26.68

### Electronic Trap Primer

#### Surface Mount Box & Panel

- DO NOT use thread sealant compound
- Do NOT disassemble or remove components. Doing so voids the warranty

Item Number	Item Description	Pkg Type	Min Qty	Case Qty	Price
695-ES05	5 Port	BI	1	1	\$1,317.01
695-ES10	10 Port	BI	1	1	\$1,433.56
695-ES15	15 Port	BI	1	1	\$1,550.12
695-ES20	20 Port	BI	1	1	\$1,666.67
695-ES30	30 Port	BI	1	1	\$1,719.11

## Electronic Trap Primer

### Recessed Box

- DO NOT use thread sealant compound
- Do NOT disassemble or remove components. Doing so voids the warranty

Item Number	Item Description	Pkg Type	Min Qty	Case Qty	Price
695-ER05	5 Port	Bl	1	1	\$1,369.46
695-ER10	10 Port	Bl	1	1	\$1,486.01
695-ER15	15 Port	Bl	1	1	\$1,602.56
695-ER20	20 Port	Bl	1	1	\$1,748.24
695-ER30	30 Port	Bl	1	1	\$1,783.20
<b>PANEL</b>					
971-1414	Outside - 15-1/4" x 15-1/4", Inside - 14" x 14", Painted Steel	B	1	1	\$134.87
971-1430	Outside - 15-1/4" x 31-1/4", Inside - 14" x 30", Painted Steel	B	1	1	\$172.46

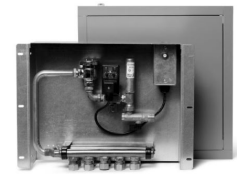

695-ER10 w/ 971-1414



971-1414

## Electronic Trap Primer

### Single Outlet Primer

- Do NOT disassemble or remove components. Doing so voids the warranty

Item Number	Item Description	Pkg Type	Min Qty	Case Qty	Price
695-ES01	Electronic Trap Primer Surface Mount	Bl	1	1	\$294.88



695-ES01

## TrapShield™

### Trap Seal Protection Device

Item Number	Item Description	Pkg Type	Min Qty	Case Qty	Price
835-2	Trapshield™ For 2" Drain Outlet	Bl	1	50	\$56.31
835-3	Trapshield™ For 3" Drain Outlet	Bl	1	25	\$63.36
835-35	Trapshield™ For 3-1/2" Drain Head	Bl	1	25	\$63.36
835-4	Trapshield™ For 4" Drain Outlet	Bl	1	20	\$74.98

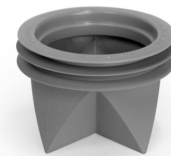

835-2



# **Access**

**Dual  $\frac{3}{4}$ " Hose Outlet - Laundry**

**Single  $\frac{3}{4}$ " Hose Outlet - Appliance**

**$\frac{1}{4}$ " Outlet - Ice Maker**

**$\frac{3}{8}$ " Outlet - Single/Dual/Multiple**

**Gas Service**

**Air Admittance Valve Box**

**Outlet Box Accessories**

**Panels**

# Access

## Outlet Boxes, Plates & Panels

Sioux Chief outlet boxes are listed by IAPMO to cUPC and are designed with inlet connections conforming to all appropriate ASTM standards. Water supply valves for potable water service meet ASME A112.18.1 and comply with NSF-61 and *California No Lead Plumbing Law*. Leaded brass options are available for non-potable water applications only.

Water hammer arresters included with applicable models are ASSE certified to the *ANSI/ASSE 1010 Performance Requirements for Water Hammer Arresters*.

Fire-rated models are listed by Warnock Hersey to meet ASTM E-814, CAN/ULC S115:  
[ 2 hours (F), 31 minutes (T) for 2-hour design | 1 hour (F), 31 minutes (T) for 1-hour design ]  
ASTM E-119, UL 1479 System design number: [ SC/WA120, W/N 14409 ]

## Custom Product Available

Sioux Chief offers OxBox™ outlet box options that are NOT listed in this catalog.  
To build your custom product number, use the guide below.

Note: Custom item must be ordered with a minimum qty of 30. Custom items are non-returnable.

### 696 A B C D E F G H

E.g. 696-2313XF = OxBox supply and drain box with two, leaded, 3/4" male hose thread outlet valves with arresters, 1/2" F1807 PEX connection and frame included.

#### **A Special Standards**

- (dash) Standard product<sup>1</sup>
- R Fire-Rated product
- G No-Lead compliant valves<sup>2</sup>
- RG Fire-Rated product with No-Lead compliant valves

#### **B Supply Box Options**

- 1 One-valve box
- 2 Two-valve box
- 3 Three-valve box
- 4 Four-valve box

#### **C Drain Box Options**

- 0 (zero) No drain box
- 3 Drain box included
- 4 Supply box with drain

#### **D Valve & Arrester Options**

- 0 (zero) No Arresters on valves
- 1 Arresters on valves
- 2 Integral, secondary stop

#### **E Outlet Options**

- 0 (zero) 1/4" Compression outlet
- 1 3/8" Compression outlet
- 3 3/4" Male hose thread outlet

#### **F Inlet Options**

- C 1/2" Male CPVC
- M 1/2" MIP/FSWT
- P 1/2" MSWT/Press/Push
- V 1/2" F3347 PEX
- W 1/2" F1960 PEX
- X 1/2" F1807 PEX

#### **G Frame Options**

- F Frames included
- R Rough-in Pack - frames not included

#### **H Additional Options** if applicable

PK4 Display box package

- 1 Leaded brass valves: C37700 or C36000
- 2 No-Lead valves: C69300 dezincification and SCC resistant material. Compliant with NSF-61 Annex G and California No-Lead Plumbing Law

# **3/4" Hose Outlet for Laundry**

**OxBox™**

**OxBox ONE™**

**OmniPanel™**

**ClassicBox™**

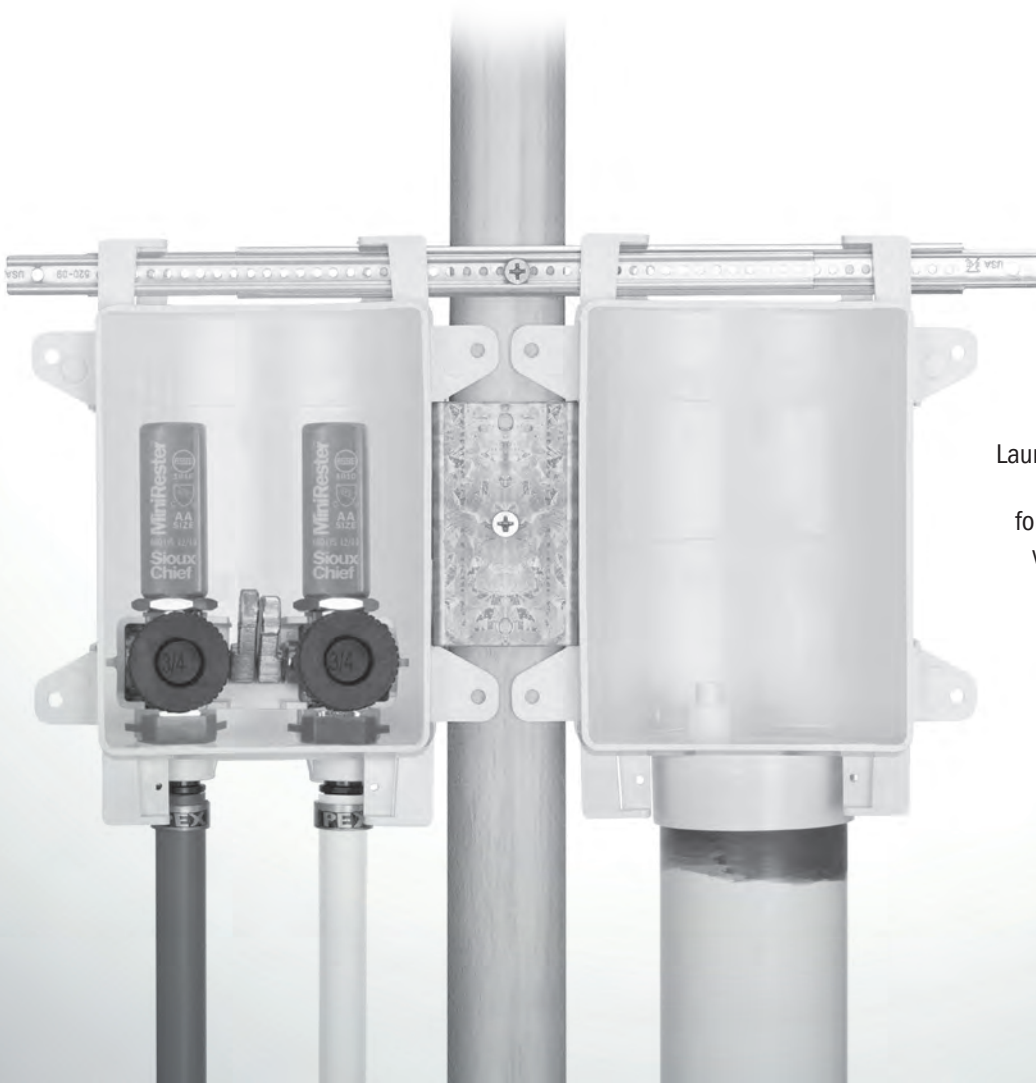

Laundry outlet boxes provide easy access to water supply valves for the washing machine. A wide variety of inlet connections are available for easy hook-up in most supply systems.



**696-G2313MF**  
Page 169



**696-G2303CR**  
Page 170



**696-G2413WF**  
Page 171



**696-G2403MR**  
Page



**698-A33ACR**  
Page 172



**698-A33-CR**  
Page 172



**688-G11WR**  
Page 173



**699-A3-XR**  
Page 177



**696-G1010WR**  
Page 181



**696RG1000XF**  
Page 182



**699RA0-XR**  
Page



**696-G1001MR**  
Page 185



**699-A1EMR**  
Page 186



**696-G2011XF**  
Page 189



**696-G2001MR**  
Page 189



**698-A11APR**  
Page 190

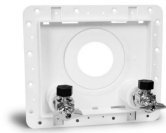

**698-A11-MR**  
Page 190



**696-G3021WR**  
Page 195



**696-1020GF**  
Page 199



**250-696122P**  
Page 203



**688-G1CE**  
Page 207



**696-3**  
Page 207



**696-2F**  
Page 208

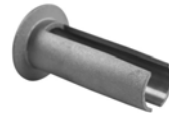

**305-RT**  
Page 209



**970-112**  
Page 213



**OxBox™ 3/4" Outlet**

**Arrester**

Item Number	Item Description	Pkg Type	Min Qty	Case Qty	Price
<b>WITH FRAME</b>					
696-G2313CF	1/2" CPVC Male	BI	10	10	\$73.66
696-G2313MF	1/2" MIP/FSWT	BI	10	10	\$73.66
696-G2313PF	1/2" MSWT/Press/Push	BI	10	10	\$73.66
696-G2313VF	1/2" F3347 PEX	BI	10	10	\$73.66
696-G2313WF	1/2" F1960 PEX	BI	10	10	\$76.66
696-G2313XF	1/2" F1807 PEX	BI	10	10	\$73.66
<b>WITH FRAME - LEADED VALVE</b>					
696-2313CF	1/2" CPVC Male	BI	10	10	\$72.92
696-2313MF	1/2" MIP/FSWT	BI	10	10	\$72.92
696-2313VF	1/2" F3347 PEX Press	BI	10	10	\$72.92
696-2313WF	1/2" F1960 PEX	BI	10	10	\$75.92
696-2313XF	1/2" F1807 PEX	BI	10	10	\$72.92
<b>ROUGH-IN</b>					
696-G2313CR	1/2" CPVC Male	BI	10	10	\$70.26
696-G2313ER	1/2" Everloc+	BI	10	10	\$75.76
696-G2313MR	1/2" MIP/FSWT	BI	1	10	\$70.26
696-G2313PR	1/2" MSWT/Press/Push	BI	10	10	\$70.26
696-G2313VR	1/2" F3347 PEX	BI	10	10	\$70.26
696-G2313WR	1/2" F1960 PEX	BI	10	10	\$73.26
696-G2313XR	1/2" F1807 PEX	BI	10	10	\$70.26
<b>ROUGH-IN - LEADED VALVE</b>					
696-2313CR	1/2" CPVC Male	BI	10	10	\$70.12
696-2313ER	1/2" Everloc+	BI	10	10	\$75.62
696-2313MR	1/2" MIP/FSWT	BI	10	10	\$70.12
696-2313WR	1/2" F1960 PEX	BI	10	10	\$73.12
696-2313XR	1/2" F1807 PEX	BI	10	10	\$70.12
<b>INDIVIDUALLY BAR-CODED IN DISPLAY BOX - LEADED VALVE</b>					
696-2313MFPK4	1/2" MIP/FSWT	BI	4	4	\$79.67



696-G2313MF



696-2313CR

**OxBox™ 3/4" Outlet**

**Non-Arrester**

Item Number	Item Description	Pkg Type	Min Qty	Case Qty	Price
<b>WITH FRAME</b>					
696-G2303CF	1/2" CPVC Male	BI	10	10	\$46.16
696-G2303MF	1/2" MIP/FSWT	BI	10	10	\$46.16
696-G2303PF	1/2" MSWT/Press/Push	BI	10	10	\$46.16
696-G2303VF	1/2" F3347 PEX	BI	10	10	\$46.16
696-G2303WF	1/2" F1960 PEX	BI	10	10	\$49.16
696-G2303XF	1/2" F1807 PEX	BI	10	10	\$46.16



696-G2303MF

Supply

Drainage

Support

Specialties

Appendix



696-G2303CR

### OxBox™ 3/4" Outlet (Cont)

#### Non-Arrester

Item Number	Item Description	Pkg Type	Min Qty	Case Qty	Price
<b>ROUGH-IN</b>					
696-G2303CR	1/2" CPVC Male	BI	10	10	\$42.76
696-G2303ER	1/2" Everloc+	BI	10	10	\$48.26
696-G2303MR	1/2" MIP/FSWT	BI	10	10	\$42.76
696-G2303PR	1/2" MSWT/Press/Push	BI	1	10	\$42.76
696-G2303VR	1/2" F3347 PEX	BI	10	10	\$42.76
696-G2303WR	1/2" F1960 PEX	BI	10	10	\$45.76
696-G2303XR	1/2" F1807 PEX	BI	10	10	\$42.76

### OxBox™ 3/4" Outlet, Fire-Rated

#### Arrester



696RG2313WF

Item Number	Item Description	Pkg Type	Min Qty	Case Qty	Price
<b>WITH FRAME</b>					
696RG2313CF	1/2" CPVC Male	BI	10	10	\$117.88
696RG2313MF	1/2" MIP/FSWT	BI	10	10	\$117.88
<b>696RG2313PF</b>	1/2" MSWT/Press/Push	BI	10	30	\$117.88
696RG2313VF	1/2" F3347 PEX Press	BI	10	10	\$117.88
696RG2313WF	1/2" F1960 PEX	BI	10	10	\$120.88
696RG2313XF	1/2" F1807 PEX	BI	10	10	\$117.88
<b>WITH FRAME - LEADED</b>					
696R2313CF	1/2" CPVC Male	BI	10	10	\$117.14
696R2313MF	1/2" MIP/FSWT	BI	10	10	\$117.14
696R2313VF	1/2" F3347 PEX Press	BI	10	10	\$117.14
696R2313WF	1/2" F1960 PEX	BI	10	10	\$120.14
696R2313XF	1/2" F1807 PEX	BI	10	10	\$117.14

### OxBox™ 3/4" Outlet, Fire-Rated

#### Non-Arrester



696RG2303MF

Item Number	Item Description	Pkg Type	Min Qty	Case Qty	Price
<b>WITH FRAME</b>					
696RG2303CF	1/2" CPVC Male	BI	10	10	\$90.38
696RG2303MF	1/2" MIP/FSWT	BI	10	10	\$90.38
<b>696RG2303VF</b>	1/2" F3347 PEX Press	BI	10	10	\$90.38
696RG2303WF	1/2" F1960 PEX	BI	10	10	\$93.38
696RG2303XF	1/2" F1807 PEX	BI	10	10	\$90.38

**OxBox ONE™ 3/4" Outlet**

**Arrester**

Item Number	Item Description	Pkg Type	Min Qty	Case Qty	Price
<b>WITH FRAME</b>					
696-G2413CF	1/2" CPVC Male	BI	10	30	\$69.16
696-G2413MF	1/2" MIP/FSWT	BI	10	10	\$55.41
696-G2413VF	1/2" F3347	BI	10	10	\$69.16
696-G2413WF	1/2" F1960 PEX	BI	10	10	\$72.16
696-G2413XF	1/2" F1807 PEX	BI	10	10	\$69.16
<b>WITH FRAME - LEADED</b>					
696-2413CF	1/2" CPVC Male	BI	10	10	\$68.42
696-2413MF	1/2" MIP/FSWT	BI	10	10	\$68.42
696-2413WF	1/2" F1960 PEX	BI	10	10	\$71.42
696-2413XF	1/2" F1807 PEX	BI	10	10	\$68.42



696-G2413WF

**OxBox ONE™ 3/4" Outlet**

**Non-Arrester**

Item Number	Item Description	Pkg Type	Min Qty	Case Qty	Price
<b>WITH FRAME</b>					
696-G2403CF	1/2" CPVC Male	BI	10	10	\$41.66
696-G2403MF	1/2" MIP/FSWT	BI	10	10	\$41.66
696-G2403WF	1/2" F1960 PEX	BI	10	10	\$44.66
696-G2403XF	1/2" F1807 PEX	BI	10	10	\$41.66



696-G2403XF

**OxBox ONE™ 3/4" Outlet, Fire-Rated**

**Arrester With Frame**

Item Number	Item Description	Pkg Type	Min Qty	Case Qty	Price
696RG2413WF	1/2" F1960 PEX	BI	10	10	\$116.38



696RG2413WF

**OxBox ONE™ 3/4" Outlet, Fire-Rated**

**Non-Arrester With Frame**

Item Number	Item Description	Pkg Type	Min Qty	Case Qty	Price
696RG2403CF	1/2" CPVC Male	BI	10	10	\$85.88
696RG2403WF	1/2" F1960 PEX	BI	10	10	\$88.88



696RG2403WF

Supply

Drainage

Support

Specialties

Appendix



698-A33ACR

### OmniPanel™ 3/4" Outlet

#### Arrester

Item Number	Item Description	Pkg Type	Min Qty	Case Qty	Price
<b>ROUGH-IN</b>					
698-A33ACR	1/2" CPVC	BI	10	10	\$68.58
698-A33AMR	1/2" MIP/FSWT	BI	10	10	\$68.58
698-A33APR	1/2" MSWT/Press/Push	BI	10	10	\$68.58
698-A33AWR	1/2" F1960 PEX	BI	10	10	\$71.58
698-A33AXR	1/2" F1807 PEX	BI	10	10	\$68.58

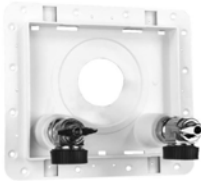

698-A33-CR

### OmniPanel™ 3/4" Outlet

#### Non-Arrester

Item Number	Item Description	Pkg Type	Min Qty	Case Qty	Price
<b>ROUGH-IN</b>					
698-A33-CR	1/2" CPVC	BI	10	10	\$41.08
698-A33-MR	1/2" MIP/FSWT	BI	10	10	\$41.08
698-A33-PR	1/2" MSWT/Press/Push	BI	10	10	\$41.08
698-A33-WR	1/2" F1960 PEX	BI	10	10	\$44.08
698-A33-XR	1/2" F1807 PEX	BI	10	10	\$41.08

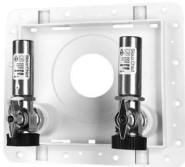

698RA33APR

### OmniPanel™ 3/4" Outlet, Fire-Rated

#### Arrester

Item Number	Item Description	Pkg Type	Min Qty	Case Qty	Price
<b>ROUGH-IN</b>					
698RA33ACR	1/2" CPVC	BI	10	10	\$88.26
698RA33AMR	1/2" MIP/FSWT	BI	10	10	\$88.08
698RA33APR	1/2" MSWT/Press/Push	BI	10	10	\$88.08
698RA33AWR	1/2" F1960 PEX	BI	10	10	\$91.08
698RA33AXR	1/2" F1807 PEX	BI	10	10	\$88.08

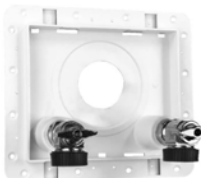

698RA33-XR

### OmniPanel™ 3/4" Outlet, Fire-Rated

#### Non-Arrester

Item Number	Item Description	Pkg Type	Min Qty	Case Qty	Price
<b>ROUGH-IN</b>					
698RA33-CR	1/2" CPVC	BI	10	10	\$60.58
698RA33-MR	1/2" MIP/FSWT	BI	10	10	\$60.58
698RA33-PR	1/2" MSWT/Press/Push	BI	10	10	\$60.58
698RA33-WR	1/2" F1960 PEX	BI	10	10	\$63.58
698RA33-XR	1/2" F1807 PEX	BI	10	10	\$60.58

**ClassicBox™ 3/4" Outlet**

**Rough-In Outlet**

Item Number	Item Description	Pkg Type	Min Qty	Case Qty	Price
<b>ARRESTER</b>					
688-G11CR	1/2" CPVC Male	BI	10	10	\$61.86
688-G11MR	1/2" MIP/FSWT	BI	10	10	\$61.86
688-G11PR	1/2" MSWT/Press/Push	BI	10	10	\$61.86
688-G11VR	1/2" F3347 PEX Press	BI	10	10	\$61.86
688-G11WR	1/2" F1960 PEX	BI	10	10	\$64.86
688-G11XR	1/2" F1807 PEX	BI	10	10	\$61.86
<b>NON-ARRESTER</b>					
688-G10CR	1/2" CPVC Male	BI	10	10	\$36.61
688-G10MR	1/2" MIP/FSWT	BI	10	10	\$36.61
688-G10PR	1/2" MSWT/Press/Push	BI	10	10	\$36.61
688-G10VR	1/2" F3347 PEX Press	BI	10	10	\$36.61
688-G10WR	1/2" F1960 PEX	BI	10	10	\$39.61
688-G10XR	1/2" F1807 PEX	BI	10	10	\$36.61



688-G11WR

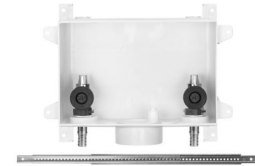

688-G10XR

Supply

Drainage

Support

Specialties

Appendix



# Single 3/4" Hose Outlet

OxBox™

ProPlate™

Boxes and outlet plates with 3/4" hose thread connection provide easy access to water supply valves for icemakers, dishwashers, humidifiers or other appliances that can be connected to common hose threads.

A wide variety of inlet connections are available for easy hook-up in most supply systems.

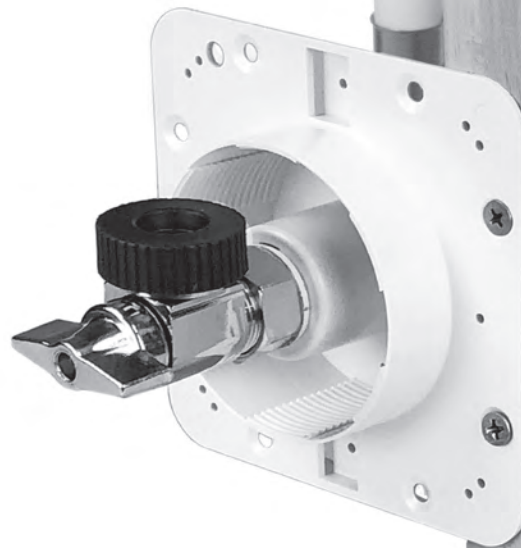



---

### Male Sweat Fittings

**PRESS-FIT COMPATIBLE** All Sioux Chief male sweat, preformed copper fittings are compatible with press-fit systems and all push fit systems. Do not use push fittings with nickel-plated stub outs.



### Lead-Free Compliant



Products made from 'Copper' or 'NL/DZR' material comply with NSF-61 & 372 and with the California No Lead Plumbing Law.



**Appliance Box**

**Arrester**

Item Number	Item Description	Pkg Type	Min Qty	Case Qty	Price
	<b>WITH FRAME</b>				
696-G1013XF	1/2" F1807 PEX	BI	10	30	\$49.72



696-G1013XF

**ProPlate™ 3/4" Outlet**

**Rough-In Outlet**

Item Number	Item Description	Pkg Type	Min Qty	Case Qty	Price
699-A3-MR	1/2" MIP/FSWT	BI	10	10	\$19.54
699-A3-PR	1/2" MSWT/Press/Push	BI	10	10	\$19.54
699-A3-WR	1/2" F1960 PEX	BI	10	10	\$21.04
699-A3-XR	1/2" F1807 PEX	BI	10	10	\$19.54



699-A3-XR

Supply

Drainage

Support

Specialties

Appendix



# 1/4" Outlet for Ice Maker

OxBox™

ProPlate™

Ice maker outlet boxes and plates provide easy access to water supply valves.

Available with water hammer arrester protection and a wide variety of inlet connections are available for easy hook-up in most supply systems.





---

### Male Sweat Fittings

**PRESS-FIT COMPATIBLE** All Sioux Chief male sweat, preformed copper fittings are compatible with press-fit systems and all push fit systems. Do not use push fittings with nickel-plated stub outs.



### Lead-Free Compliant



Products made from 'Copper' or 'NL/DZR' material comply with NSF-61 & 372 and with the California No Lead Plumbing Law.

**OxBox™ 1/4" Outlet****Arrester**

Item Number	Item Description	Pkg Type	Min Qty	Case Qty	Price
<b>WITH FRAME</b>					
696-G1010CF	1/2" CPVC Male	BI	10	10	\$49.72
696-G1010MF	1/2" MIP/FSWT	BI	10	10	\$49.72
<b>696-G1010PF</b>	1/2" MSWT/Press/Push	BI	10	30	\$49.72
696-G1010VF	1/2" F3347 PEX Press	BI	10	10	\$49.72
696-G1010WF	1/2" F1960 PEX	BI	10	10	\$52.72
696-G1010XF	1/2" F1807 PEX	BI	10	10	\$49.72
<b>ROUGH IN</b>					
696-G1010CR	1/2" CPVC Male	BI	10	10	\$46.92
696-G1010MR	1/2" MIP/FSWT	BI	10	10	\$46.92
696-G1010PR	1/2" MSWT/Press/Push	BI	10	10	\$46.92
696-G1010VR	1/2" F3347 PEX Press	BI	10	10	\$46.92
696-G1010WR	1/2" F1960 PEX	BI	10	10	\$49.92
696-G1010XR	1/2" F1807 PEX	BI	10	10	\$46.92
<b>WITH FRAME &amp; 72" STAINLESS STEEL HOSE</b>					
696-G1010XFS	1/2" F1807 PEX	BI	10	10	\$57.72



696-G1010CF



696-G1010WR



696-G1010XFS

**OxBox™ 1/4" Outlet****Non-Arrester**

Item Number	Item Description	Pkg Type	Min Qty	Case Qty	Price
<b>WITH FRAME</b>					
696-G1000CF	1/2" CPVC Male	BI	10	10	\$35.97
696-G1000MF	1/2" MIP/FSWT	BI	10	10	\$35.97
696-G1000PF	1/2" MSWT/Press/Push	BI	10	10	\$35.97
696-G1000VF	1/2" F3347 PEX Press	BI	10	10	\$35.97
696-G1000WF	1/2" F1960 PEX	BI	10	10	\$38.97
696-G1000XF	1/2" F1807 PEX	BI	10	10	\$35.97
<b>ROUGH-IN</b>					
696-G1000CR	1/2" CPVC Male	BI	10	10	\$33.17
696-G1000MR	1/2" MIP/FSWT	BI	10	10	\$33.17
696-G1000WR	1/2" F1960 PEX	BI	10	10	\$36.17
696-G1000XR	1/2" F1807 PEX	BI	10	10	\$33.17
<b>INDIVIDUALLY BAR-CODED IN DISPLAY BOX</b>					
696-G1000MFPK4	1/2" MIP/FSWT	BI	5	5	\$42.72
<b>WITH FRAME &amp; 72" STAINLESS STEEL HOSE</b>					
696-G1000XFS	1/2" F1807 PEX	BI	10	10	\$43.97



696-G1000XF



696-G1000MFPK4

Supply

Drainage

Support

Specialties

Appendix

Supply

Drainage

Support

Specialties

Appendix



696RG1010VF

### OxBox™ 1/4" Outlet, Fire-Rated

#### Arrester

Item Number	Item Description	Pkg Type	Min Qty	Case Qty	Price
<b>WITH FRAME</b>					
696RG1010CF	1/2" CPVC Male	BI	10	10	\$93.94
696RG1010MF	1/2" MIP/FSWT	BI	10	10	\$93.94
696RG1010PF	1/2" MSWT/Press/Push	BI	10	30	\$93.94
696RG1010VF	1/2" F3347 PEX Press	BI	10	10	\$93.94
696RG1010WF	1/2" F1960 PEX	BI	10	10	\$96.94
696RG1010XF	1/2" F1807 PEX	BI	10	10	\$93.94



696RG1000XF

### OxBox™ 1/4" Outlet, Fire-Rated

#### Non-Arrester

Item Number	Item Description	Pkg Type	Min Qty	Case Qty	Price
<b>WITH FRAME</b>					
696RG1000CF	1/2" CPVC Male	BI	10	10	\$80.19
696RG1000MF	1/2" MIP/FSWT	BI	10	10	\$80.19
696RG1000VF	1/2" F3347 PEX Press	BI	10	10	\$80.19
696RG1000WF	1/2" F1960 PEX	BI	10	10	\$83.19
696RG1000XF	1/2" F1807 PEX	BI	10	10	\$80.19



699-A0-XR

### ProPlate™ 1/4" Outlet

#### Rough-In Outlet

Item Number	Item Description	Pkg Type	Min Qty	Case Qty	Price
699-A0-CR	1/2" CPVC	BI	10	10	\$19.54
699-A0-MR	1/2" MIP/FSWT	BI	10	10	\$19.54
699-A0-PR	1/2" MSWT/Press/Push	BI	10	10	\$19.54
<b>699-A0-VR</b>	1/2" F3347 PEX Press	BI	10	30	\$19.54
699-A0-WR	1/2" F1960 PEX	BI	10	10	\$21.04
699-A0-XR	1/2" F1807 PEX	BI	10	10	\$19.54

# Single $\frac{3}{8}$ " Outlet for Lav, Toilet or Dishwasher

**OxBox™**

**ProPlate™**

Outlet boxes and plates provide easy access to  $\frac{3}{8}$ " water supply valves for toilet or dishwasher.

Available with water hammer arrester protection and a wide variety of inlet connections are available for easy hook-up in most supply systems.





### Male Sweat Fittings

**PRESS-FIT COMPATIBLE** All Sioux Chief male sweat, preformed copper fittings are compatible with press-fit systems and all push fit systems. Do not use push fittings with nickel-plated stub outs.



### Lead-Free Compliant



Products made from 'Copper' or 'NL/DZR' material comply with NSF-61 & 372 and with the California No Lead Plumbing Law.



**OxBox™ 3/8" Outlet-Single valve**

**Arrester**

Item Number	Item Description	Pkg Type	Min Qty	Case Qty	Price
<b>WITH FRAME</b>					
696-G1011CF	1/2" CPVC Male	BI	10	10	\$49.72
696-G1011MF	1/2" MIP/FSWT	BI	10	10	\$49.72
<b>696-G1011PF</b>	1/2" MSWT/Press/Push	BI	10	30	\$49.72
696-G1011VF	1/2" F3347 PEX Press	BI	10	10	\$49.72
696-G1011WF	1/2" F1960 PEX	BI	10	10	\$52.72
696-G1011XF	1/2" F1807 PEX	BI	10	10	\$49.72



696-G1011XF

**OxBox™ 3/8" Outlet-Single valve**

**Non-Arrester**

Item Number	Item Description	Pkg Type	Min Qty	Case Qty	Price
<b>WITH FRAME</b>					
696-G1001CF	1/2" CPVC Male	BI	10	10	\$35.97
696-G1001MF	1/2" MIP/FSWT	BI	10	10	\$35.97
696-G1001PF	1/2" MSWT/Press/Push	BI	10	10	\$35.97
696-G1001VF	1/2" F3347 PEX Press	BI	10	10	\$35.97
696-G1001WF	1/2" F1960 PEX	BI	10	10	\$38.97
696-G1001XF	1/2" F1807 PEX	BI	10	10	\$35.97
<b>ROUGH-IN</b>					
696-G1001CR	1/2" CPVC Male	BI	10	10	\$33.17
696-G1001MR	1/2" MIP/FSWT	BI	10	10	\$33.17
696-G1001WR	1/2" F1960 PEX	BI	10	10	\$36.17
696-G1001XR	1/2" F1807 PEX	BI	10	10	\$33.17



696-G1001CF



696-G1001MR

**OxBox™ 3/8" Outlet, Fire-Rated - Single Valve**

**Arrester**

Item Number	Item Description	Pkg Type	Min Qty	Case Qty	Price
<b>WITH FRAME</b>					
<b>696RG1011CF</b>	1/2" CPVC Male	BI	10	30	\$93.94
<b>696RG1011MF</b>	1/2" MIP/FSWT	BI	10	30	\$93.94
<b>696RG1011XF</b>	1/2" F1807 PEX	BI	10	30	\$93.94



696RG1011XF

Supply

Drainage

Support

Specialties

Appendix



696RG1001WF

**OxBox™ 3/8" Outlet, Fire-Rated - Single Valve  
Non-Arrester**

Item Number	Item Description	Pkg Type	Min Qty	Case Qty	Price
<b>WITH FRAME</b>					
696RG1001CF	1/2" CPVC Male	BI	10	10	\$80.19
696RG1001MF	1/2" MIP/FSWT	BI	10	10	\$80.19
<b>696RG1001VF</b>	1/2" F3347 PEX Press	BI	10	30	\$80.19
696RG1001WF	1/2" F1960 PEX	BI	10	10	\$83.19
696RG1001XF	1/2" F1807 PEX	BI	10	10	\$80.19

**ProPlate™ 3/8" Outlet  
Rough-In Outlet**



699-A1-XR



699-A1EMR

Item Number	Item Description	Pkg Type	Min Qty	Case Qty	Price
699-A1-CR	1/2" CPVC	BI	10	10	\$19.54
699-A1-MR	1/2" MIP/FSWT	BI	10	10	\$19.54
699-A1-PR	1/2" MSWT/Press/Push	BI	10	10	\$19.54
<b>699-A1-VR</b>	1/2" F3347 PEX Press	BI	10	30	\$19.54
699-A1-WR	1/2" F1960 PEX	BI	10	10	\$21.04
699-A1-XR	1/2" F1807 PEX	BI	10	10	\$19.54
<b>EXTENDED VALVE</b>					
699-A1ECR	1/2" CPVC	BI	10	10	\$24.54
699-A1EMR	1/2" MIP/FSWT	BI	10	10	\$24.54
699-A1EPR	1/2" MSWT/Press/Push	BI	10	10	\$24.54
699-A1EVR	1/2" F3347 PEX Press	BI	10	10	\$24.54
699-A1EWR	1/2" F1960 PEX	BI	10	10	\$26.04
699-A1EXR	1/2" F1807 PEX	BI	10	10	\$24.54

**ProPlate™ 3/8" Outlet  
Fire-Rated Rough-In Outlet**

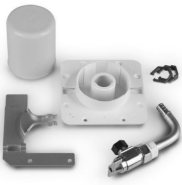

699RA1-XR



699RA1EMR

Item Number	Item Description	Pkg Type	Min Qty	Case Qty	Price
<b>699RA1-MR</b>	1/2" MIP/FSWT	BI	10	30	\$32.74
<b>699RA1-PR</b>	1/2" MSWT/Press/Push	BI	10	30	\$32.74
699RA1-WR	1/2" F1960 PEX	BI	10	10	\$34.24
699RA1-XR	1/2" F1807 PEX	BI	10	10	\$32.74
<b>EXTENDED VALVE</b>					
<b>699RA1EMR</b>	1/2" MIP/FSWT	BI	10	30	\$37.74
<b>699RA1EPR</b>	1/2" MSWT/Press/Push	BI	10	30	\$37.74
699RA1EWR	1/2" F1960 PEX	BI	10	10	\$39.24
699RA1EXR	1/2" F1807 PEX	BI	10	10	\$37.74

# Dual 3/8" Outlets for Lavatory

OxBox™

OmniPanel™

The OxBox™ outlet box and unique OmniPanel™ valved access plate provide quality, dual 3/8" water supply valves for lavatory applications.

Available with water hammer arrester protection and a wide variety of inlet connections are available for easy hook-up in most supply systems.





### Male Sweat Fittings

**PRESS-FIT COMPATIBLE** All Sioux Chief male sweat, preformed copper fittings are compatible with press-fit systems and all push fit systems. Do not use push fittings with nickel-plated stub outs.



### Lead-Free Compliant

**LEAD FREE COMPLIANT** Products made from 'Copper' or 'NL/DZR' material comply with NSF-61 & 372 and with the California No Lead Plumbing Law.

**OxBox™ 3/8" Outlets - Dual valve**

**Arrester**

Item Number	Item Description	Pkg Type	Min Qty	Case Qty	Price
<b>WITH FRAME</b>					
696-G2011CF	1/2" CPVC Male	BI	10	10	\$72.88
696-G2011MF	1/2" MIP/FSWT	BI	10	10	\$72.88
696-G2011VF	1/2" Viega PEX Press	BI	10	10	\$72.88
696-G2011WF	1/2" F1960 PEX	BI	10	10	\$75.88
696-G2011XF	1/2" F1807 PEX	BI	10	10	\$72.88



696-G2011XF

**OxBox™ 3/8" Outlets - Dual valve**

**Non-Arrester**

Item Number	Item Description	Pkg Type	Min Qty	Case Qty	Price
<b>WITH FRAME</b>					
696-G2001CF	1/2" CPVC Male	BI	10	10	\$45.38
696-G2001MF	1/2" MIP/FSWT	BI	10	10	\$45.38
696-G2001PF	1/2" MSWT/Press/Push	BI	10	10	\$45.38
696-G2001VF	1/2" F3347 PEX Press	BI	10	10	\$45.38
696-G2001WF	1/2" F1960 PEX	BI	10	10	\$48.38
696-G2001XF	1/2" F1807 PEX	BI	10	10	\$45.38
<b>ROUGH-IN</b>					
696-G2001CR	1/2" CPVC Male	BI	10	10	\$41.98
696-G2001MR	1/2" MIP/FSWT	BI	10	10	\$41.98
696-G2001PR	1/2" MSWT/Press/Push	BI	10	10	\$41.98
696-G2001WR	1/2" F1960 PEX	BI	10	10	\$44.98
696-G2001XR	1/2" F1807 PEX	BI	10	10	\$41.98



696-G2001MF



696-G2001MR

**OxBox™ 3/8" Outlets, Fire-Rated - Dual Valve**

**Arrester**

Item Number	Item Description	Pkg Type	Min Qty	Case Qty	Price
<b>WITH FRAME</b>					
696RG2011CF	1/2" CPVC Male	BI	10	30	\$117.10
696RG2011VF	1/2" F3347 PEX Press	BI	10	30	\$117.10
696RG2011XF	1/2" F1807 PEX	BI	10	30	\$117.10

Supply

Drainage

Support

Specialties

Appendix



696RG2001XF

### OxBox™ 3/8" Outlets, Fire-Rated - Dual Valve

#### Non-Arrester

Item Number	Item Description	Pkg Type	Min Qty	Case Qty	Price
<b>WITH FRAME</b>					
696RG2001CF	1/2" CPVC Male	BI	10	10	\$89.60
696RG2001MF	1/2" MIP/FSWT	BI	10	10	\$89.60
696RG2001PF	1/2" MSWT/Press/Push	BI	10	10	\$89.60
696RG2001VF	1/2" F3347 PEX Press	BI	10	10	\$89.60
696RG2001WF	1/2" F1960 PEX	BI	10	10	\$92.60
696RG2001XF	1/2" F1807 PEX	BI	10	10	\$89.60



696-T2001XR

### OxBox™ 3/8" Outlets, TMV, Dual Outlet

Item Number	Item Description	Pkg Type	Min Qty	Case Qty	Price
<b>ROUGH-IN</b>					
696-T2001CR	1/2" CPVC Male	BI	1	1	\$156.00
696-T2001PR	1/2" MSWT/Press/Push	BI	1	1	\$156.00
696-T2001WR	1/2" F1960 PEX	BI	1	1	\$156.00
696-T2001XR	1/2" F1807 PEX	BI	1	1	\$156.00
<b>REPAIR KITS</b>					
<b>120-TM3F-1</b>	THERMOSTATIC MIX VLV SCREEN KIT, 2/BG	BI	1	500	\$0.87
120-TM3F-2	THERMOSTATIC MIX VLV PISTON REPAIR KIT, 1/BG	BI	1	300	\$14.65
120-TM3F-3	THERMOSTATIC MIX VLV CHECK VALVE REPAIR KIT, 1/BG	BI	1	500	\$4.39

### OmniPanel™ 3/8" Outlets

#### Arrester



698-A11APR

Item Number	Item Description	Pkg Type	Min Qty	Case Qty	Price
<b>ROUGH-IN</b>					
698-A11APR	1/2" MSWT/Press/Push	BI	10	10	\$68.58
698-A11AWR	1/2" F1960 PEX	BI	10	10	\$71.58
698-A11AXR	1/2" F1807 PEX	BI	10	10	\$68.58

### OmniPanel™ 3/8" Outlets

#### Non-Arrester

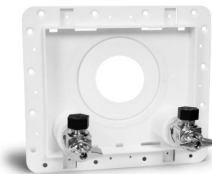

698-A11-MR

Item Number	Item Description	Pkg Type	Min Qty	Case Qty	Price
<b>ROUGH-IN</b>					
698-A11-MR	1/2" MIP/FSWT	BI	10	10	\$41.08
698-A11-PR	1/2" MSWT/Press/Push	BI	10	10	\$41.08
<b>698-A11-VR</b>	1/2" F3347 PEX Press	BI	10	10	\$41.08
698-A11-WR	1/2" F1960 PEX	BI	10	10	\$44.08
698-A11-XR	1/2" F1807 PEX	BI	10	10	\$41.08

### OmniPanel™ 3/8" Outlets, Fire-Rated

#### Arrester

Item Number	Item Description	Pkg Type	Min Qty	Case Qty	Price
<b>ROUGH-IN</b>					
698RA11APR	1/2" MSWT/Press/Push	BI	10	10	\$88.08
698RA11AWR	1/2" F1960 PEX	BI	10	10	\$91.08
698RA11AXR	1/2" F1807 PEX	BI	10	10	\$88.08



698RA11AWR

### OmniPanel™ 3/8" Outlets, Fire-Rated

#### Non-Arrester

Item Number	Item Description	Pkg Type	Min Qty	Case Qty	Price
<b>ROUGH-IN</b>					
698RA11-CR	1/2" CPVC	BI	10	10	\$60.58
698RA11-MR	1/2" MIP/FSWT	BI	10	10	\$60.58
698RA11-PR	1/2" MSWT/Press/Push	BI	10	10	\$60.58
698RA11-VR	1/2" F3347 PEX Press	BI	10	10	\$60.58
698RA11-WR	1/2" F1960 PEX	BI	10	10	\$63.58
698RA11-XR	1/2" F1807 PEX	BI	10	10	\$60.58

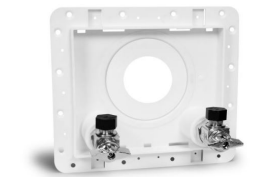

698RA11-PR

Supply

Drainage

Support

Specialties

Appendix





# Multiple Outlets for Kitchen Sink

OxBox™

The OxBox™ outlet box provides multiple combinations of 3/8" (sink/dishwasher) and 1/4" (ice maker) water supply valves for almost any kitchen water supply application.

Available with water hammer arrester protection and a wide variety of inlet connections are available for easy hook-up in most supply systems.

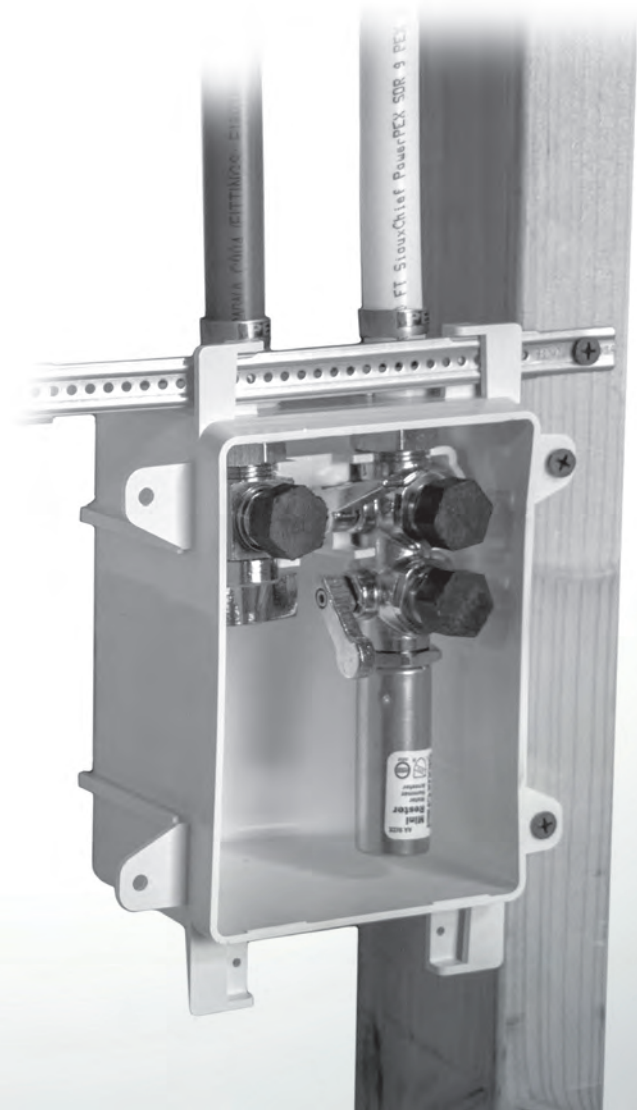



### Male Sweat Fittings

**PRESS-FIT COMPATIBLE** All Sioux Chief male sweat, preformed copper fittings are compatible with press-fit systems and all push fit systems. Do not use push fittings with nickel-plated stub outs.



### Lead-Free Compliant



Products made from 'Copper' or 'NL/DZR' material comply with NSF-61 & 372 and with the California No Lead Plumbing Law.

**OxBox™ 3/8" Outlets, Multi-Valve**

**3 Valve Rough-In Outlet**

Item Number	Item Description	Pkg Type	Min Qty	Case Qty	Price
<b>THREE 3/8" OUTLETS WITH HOT-SIDE ARRESTER</b>					
696-G3011CR	1/2" CPVC Male - 2 × Hot, 1 × Cold	BI	10	10	\$73.33
696-G3011MR	1/2" FSWT / MIP - 2 × Hot, 1 × Cold	BI	10	10	\$73.33
696-G3011PR	1/2" MSWT / Press / Push - 2 × Hot, 1 × Cold	BI	10	30	\$73.33
696-G3011VR	1/2" F3347 PEX Press - 2 × Hot, 1 × Cold	BI	10	30	\$73.83
696-G3011WR	1/2" F1960 PEX - 2 × Hot, 1 × Cold	BI	10	10	\$76.33
696-G3011XR	1/2" F1807 PEX - 2 × Hot, 1 × Cold	BI	10	10	\$73.33
<b>TWO 3/8" &amp; ONE 1/4" OUTLET WITH COLD-SIDE ARRESTER</b>					
696-G3014CR	1/2" Male CPVC - 1 X 3/8 Hot, 1 X 3/8 Cold, 1 X 1/4 Cold	BI	10	30	\$73.33
696-G3014MR	1/2" FSWT / MIP - 1 X 3/8 Hot, 1 X 3/8 Cold, 1 X 1/4 Cold	BI	10	30	\$73.33
696-G3014PR	1/2" MSWT / Press / Push - 1 X 3/8 Hot, 1 X 3/8 Cold, 1 X 1/4 Cold	BI	10	30	\$73.33
696-G3014WR	1/2" F1960 PEX - 1 X 3/8 Hot, 1 X 3/8 Cold, 1 X 1/4 Cold	BI	10	30	\$76.33
696-G3014XR	1/2" F1807 PEX - 1 X 3/8 Hot, 1 X 3/8 Cold, 1 X 1/4 Cold	BI	10	30	\$73.33
<b>THREE 3/8" OUTLETS WITH DUAL ARRESTERS</b>					
696-G3021CR	1/2" Male CPVC - 2 X Hot, 1 X Cold	BI	10	30	\$87.08
696-G3021MR	1/2" FSWT / MIP - 2 X Hot, 1 X Cold	BI	10	30	\$87.08
696-G3021WR	1/2" F1960 PEX - 2 × Hot, 1 × Cold	BI	10	10	\$90.08
696-G3021XR	1/2" F1807 PEX - 2 × Hot, 1 × Cold	BI	10	30	\$87.08
<b>TWO 3/8" &amp; ONE 1/4" OUTLET WITH DUAL ARRESTERS</b>					
696-G3024CR	1/2" Male CPVC - 1 × 3/8 Hot, 1 × 3/8 Cold, 1/4 Cold	BI	10	30	\$87.08
696-G3024MR	1/2" FSWT / MIP - 1 × 3/8 Hot, 1 × 3/8 Cold, 1/4 Cold	BI	10	30	\$87.08
696-G3024WR	1/2" F1960 PEX - 1 × 3/8 Hot, 1 × 3/8 Cold, 1/4 Cold	BI	10	30	\$90.08
696-G3024XR	1/2" F1807 PEX - 1 × 3/8 Hot, 1 × 3/8 Cold, 1/4 Cold	BI	10	30	\$87.08



696-G3011WR



696-G3021WR



696-G3024WR

**OxBox™ 3/8" Outlets, Multi-Valve**

**4 Valve Rough-In Outlet**

Item Number	Item Description	Pkg Type	Min Qty	Case Qty	Price
<b>FOUR 3/8" OUTLETS WITH DUAL ARRESTERS</b>					
696-G4021CR	1/2" Male CPVC - 2 × Hot, 2 × Cold	BI	10	10	\$104.08
696-G4021MR	1/2" FSWT / MIP - 2 × Hot, 2 × Cold	BI	10	30	\$104.08
696-G4021PR	1/2" MSWT / Press / Push - 2 × Hot, 2 × Cold	BI	10	30	\$104.08
696-G4021WR	1/2" F1960 PEX - 2 × Hot, 2 × Cold	BI	10	30	\$107.08
696-G4021XR	1/2" F1807 PEX - 2 × Hot, 2 × Cold	BI	10	30	\$104.08



696-G4021WR

Supply

Drainage

Support

Specialties

Appendix



696-G4024WR

### OxBox™ 3/8" Outlets, Multi-Valve (Cont)

#### 4 Valve Rough-In Outlet

Item Number	Item Description	Pkg Type	Min Qty	Case Qty	Price
<b>THREE 3/8" &amp; ONE 1/4" OUTLET WITH DUAL ARRESTERS</b>					
696-G4024CR	1/2" Male CPVC - 2 × 3/8 Hot, 1 × 3/8 Cold, 1 × 1/4 Cold	BI	10	10	\$104.08
696-G4024MR	1/2" FSWT / MIP - 2 × 3/8 Hot, 1 × 3/8 Cold, 1 × 1/4 Cold	BI	10	30	\$104.08
696-G4024PR	1/2" MSWT / Press / Push - 2 × 3/8 Hot, 1 × 3/8 Cold, 1 × 1/4 Cold	BI	10	30	\$104.08
696-G4024WR	1/2" F1960 PEX - 2 × 3/8 Hot, 1 × 3/8 Cold, 1 × 1/4 Cold	BI	10	30	\$107.08
696-G4024XR	1/2" F1807 PEX - 2 × 3/8 Hot, 1 × 3/8 Cold, 1 × 1/4 Cold	BI	10	30	\$104.08



696-G3011WF

### OxBox™ 3/8" Outlets, Multi-Valve

#### 3 Valve With Frame Fire-Rated Outlet

Item Number	Item Description	Pkg Type	Min Qty	Case Qty	Price
<b>THREE 3/8" OUTLETS WITH HOT-SIDE ARRESTER</b>					
696RG3011PF	1/2" MSWT / Press / Push - 2 × Hot, 1 × Cold	BI	10	10	\$120.35
696RG3011VF	1/2" F3347 PEX Press - 2 × Hot, 1 × Cold	BI	10	10	\$120.35
696RG3011WF	1/2" F1960 PEX - 2 × Hot, 1 × Cold	BI	10	10	\$123.35
696RG3011XF	1/2" F1807 PEX - 2 × Hot, 1 × Cold	BI	10	10	\$120.35
<b>THREE 3/8" OUTLETS WITH DUAL ARRESTERS</b>					
696RG3021WF	1/2" F1960 PEX - 2 × Hot, 1 × Cold	BI	10	30	\$137.10

### OxBox™ 3/8" Outlets, Multi-Valve

#### 4 Valve With Frame Fire-Rated Outlet

Item Number	Item Description	Pkg Type	Min Qty	Case Qty	Price
<b>FOUR 3/8" OUTLETS WITH DUAL ARRESTERS</b>					
696RG4021MF	1/2" FSWT / MIP - 2 × Hot, 2 × Cold	BI	10	30	\$151.10
696RG4021WF	1/2" F1960 PEX - 2 X Hot, 2 X Cold	BI	10	30	\$154.10
<b>THREE 3/8" &amp; ONE 1/4" OUTLET WITH DUAL ARRESTERS</b>					
696RG4024XF	1/2" F1807 PEX - 2 × 3/8 Hot, 1 × 3/8 Cold, 1 × 1/4 Cold	BI	10	10	\$151.10

# Gas Service

OxBox™

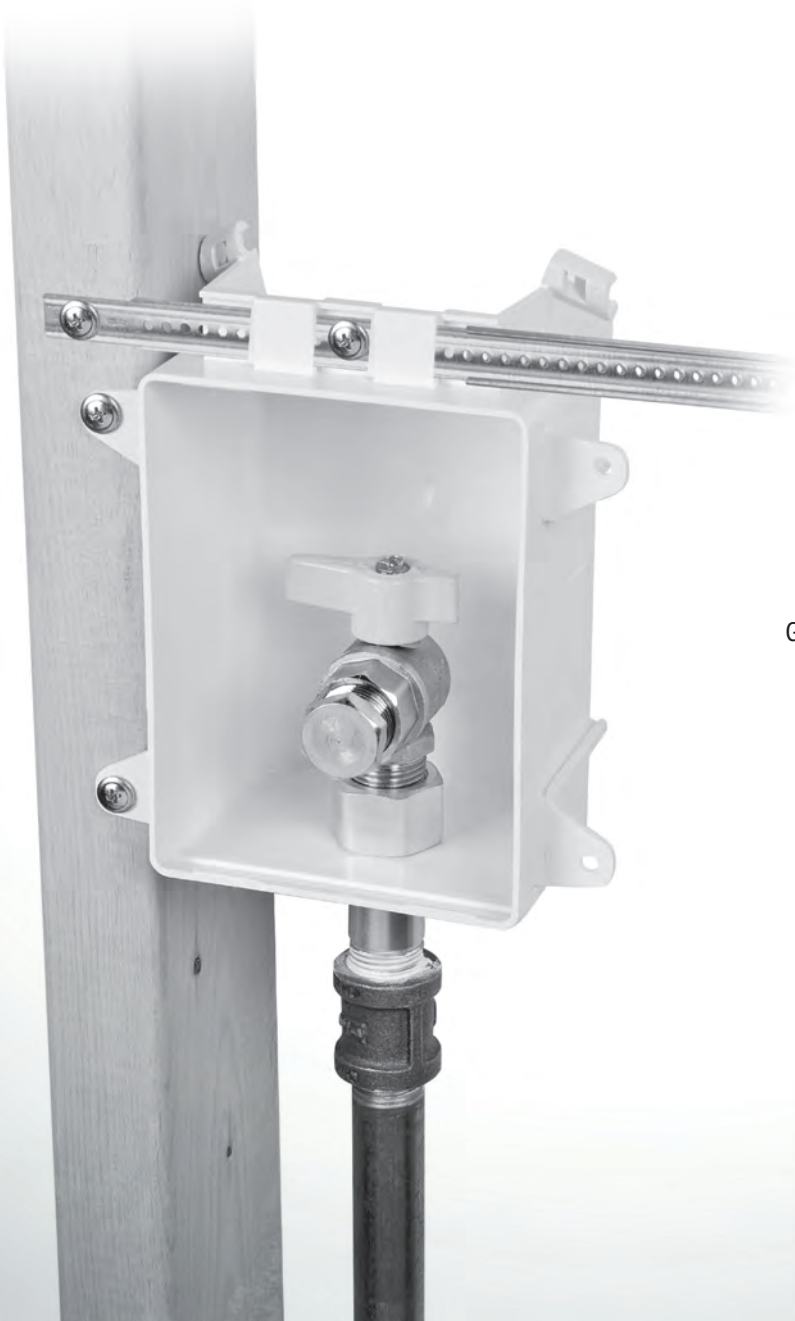

Gas service outlet boxes provide easy access to shut-off valves for stoves, clothes dryers, or any gas appliance.



**OxBox™ Gas**

**Outlet Box**

· CSST box requires box adapter from CSST manufacturer

Item Number	Item Description	Pkg Type	Min Qty	Case Qty	Price
<b>WITH FRAME - LEADED</b>					
696-1020GF	1/2" FIP Valve For CSST Connection, Bagged	BI	6	6	\$36.50
696-1021GF	1/2" NPT Valve And Adapter For Iron Pipe, Bagged	BI	6	6	\$36.50
696-1031GF	3/4" NPT Valve And Adapter For Iron Pipe, Bagged	BI	6	6	\$37.65



696-1020GF

**OxBox™ Gas**

**Fire-Rated Outlet Box**

· CSST box requires box adapter from CSST manufacturer

Item Number	Item Description	Pkg Type	Min Qty	Case Qty	Price
<b>WITH FRAME - LEADED</b>					
696R1020GF	1/2" FIP Valve For CSST Connection, Bagged	BI	10	10	\$80.72
696R1021GF	1/2" NPT Valve And Adapter For Iron Pipe, Bagged	BI	10	10	\$80.72
696R1031GF	3/4" NPT Valve And Adapter For Iron Pipe, Bagged	BI	10	10	\$80.72



696R1021GF

Supply

Drainage

Support

Specialties

Appendix





# Air Admittance Valve Box

OxBox™

Access boxes are typically required when installing air admittance valves in a stud wall. The OxBox™ provides necessary air flow to the valve and allows for inspection, maintenance or replacement of the valve.

For a less obtrusive look, paintable frames and louvered covers help fixtures blend with wall colors.

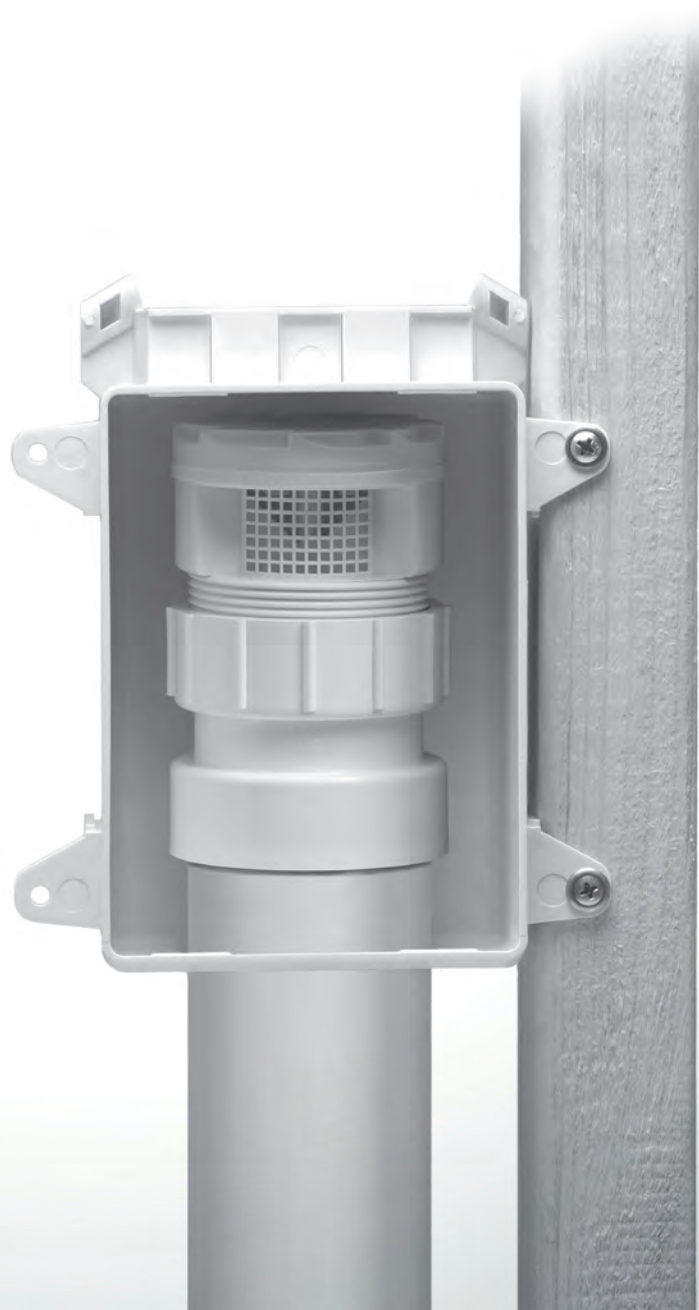



**OxBox™ TurboVent™**

Item Number	Item Description	Pkg Type	Min Qty	Case Qty	Price
<b>PVC CONNECTION - WITH FRAME</b>					
250-696122P	TurboVent™ AAV w/ 1-1/2" - 2" Dual Fit Adapter & OxBox™ Kit	Bl	1	6	\$34.11
696-11P	TurboVent™ AAV w/ 1-1/2" Hub Adapter & OxBox™ Kit	Bl	1	6	\$35.65
696-12P	TurboVent™ AAV w/ 2" Hub Adapter & OxBox™ Kit	Bl	1	6	\$36.65
<b>ABS CONNECTION - WITH FRAME</b>					
250-696122A	TurboVent™ AAV w/ 1-1/2" - 2" Dual Fit Adapter	Bl	1	6	\$34.11
696-11A	TurboVent™ AAV w/ 1-1/2" Hub Adapter & OxBox™ Kit	Bl	1	6	\$35.65
696-12A	TurboVent™ AAV w/ 2" Hub Adapter & OxBox™ Kit	Bl	1	6	\$36.65



250-696122P



696-11A

**OxBox™ TurboVent™**

**Fire-Rated Outlet**

Item Number	Item Description	Pkg Type	Min Qty	Case Qty	Price
<b>PVC CONNECTION - WITH FRAME</b>					
250-696R122P	TurboVent™ AAV w/ 1-1/2" - 2" Dual Fit Adapter & Fire Rated OxBox™ Kit	Bl	1	6	\$86.74
<b>ABS CONNECTION - WITH FRAME</b>					
250-696R122A	TurboVent™ AAV w/ 1-1/2" - 2" Dual Fit Adapter	Bl	1	6	\$86.74



250-696R122P



250-696R122A

- Supply
- Drainage
- Support
- Specialties
- Appendix



# Outlet Box Accessories

**Valves**

**Boxes**

**Debris Covers**

**Frames & Extensions**

**Box Clips, Brackets & Supports**

**Secondary Drainage Funnel**

**Clips, Nuts & Caps**



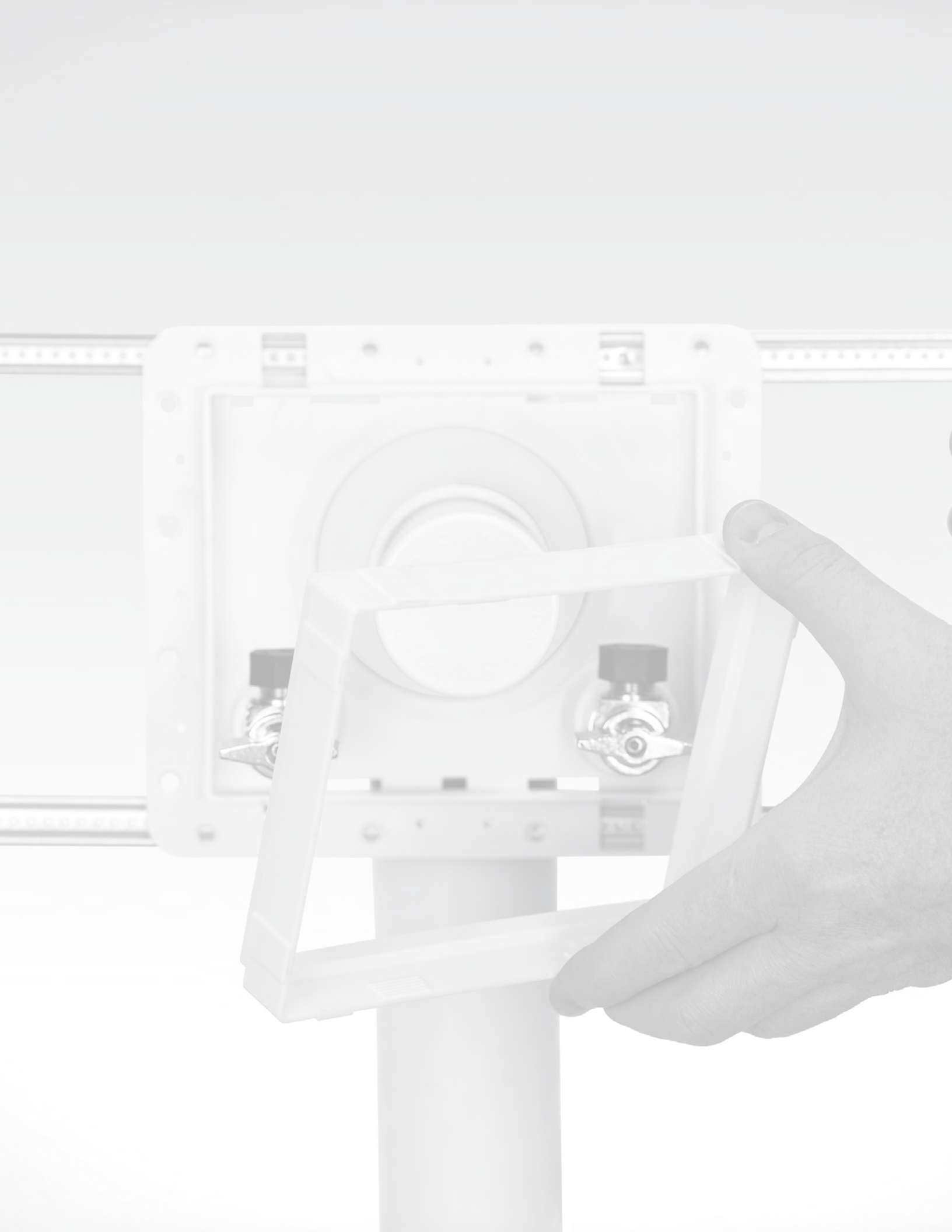

Valves

Extension Valves

Item Number	Item Description	Pkg Type	Min Qty	Case Qty	Price
<b>NL/DZR BRASS</b>					
688-G1CE	Extended Replacement Valve - 5/8" OD Comp. Thread x 3/8" OD Comp. Outlet	BI	10	10	\$9.87



688-G1CE

Boxes

Item Number	Item Description	Pkg Type	Min Qty	Case Qty	Price
<b>OXBOX™</b>					
696-1	One-Hole Supply Box	B	10	10	\$5.91
696-2	Two-Hole Supply Box	B	10	10	\$5.91
696-3	Drain Box	B	10	10	\$5.91
696-3F	Drain Box w/ Single Frame	B	10	10	\$8.21
696-4	One-Hole Supply Box/Gas	B	10	10	\$5.91
696-5	1-5/16" One-Hole Supply Box For Large Shank Valves	B	10	10	\$5.91
696-6	1-1/2" One-Hole Box For DWV Pipe	B	10	10	\$5.91
696-7	OxBox – Single Box w/ Hole For 2" Sch. 40 Pipe	B	10	10	\$5.91
696R3	Drain Box w/ Fire Pad And Frame	BI	10	10	\$50.13
<b>CLASSICBOX™</b>					
688-1	ClassicBox™ Box Only	B	10	10	\$9.36



696-3



688-1

Debris Covers

Item Number	Item Description	Pkg Type	Min Qty	Case Qty	Price
<b>PROPLATE™</b>					
699-DC	Debris Cover For ProPlate™	B	10	10	\$1.42
<b>OMNIPANEL™</b>					
698-DC	Debris Cover For OmniPanel™	B	24	24	\$2.90



699-DC



698-DC

Supply

Drainage

Support

Specialties

Appendix

Supply

Drainage

Support

Specialties

Appendix

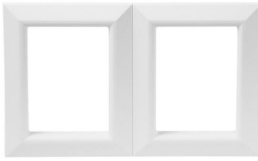

696-2F

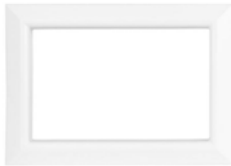

688-F



699-FC



696-C3



696-BC



520-09



696-CF

### Frames, Inserts, & Extensions

Item Number	Item Description	Pkg Type	Min Qty	Case Qty	Price
<b>OXBOX™</b>					
696-1F	Single Frame For OxBox™	B	10	10	\$2.30
696-2F	Double Frame For OxBox™	B	10	10	\$2.90
696-EX	Frame Extension	B	10	10	\$3.84
696-LC	Louvered Frame Insert	B	10	10	\$4.73
696-SC	Solid Frame Insert	B	10	10	\$4.73
696-SC1	Solid Frame Insert w/ Valve Cutout	B	10	10	\$4.73
697-1FL	Ss Locking Door w/ Frame	B	10	10	\$20.30
<b>CLASSICBOX™</b>					
688-F	ClassicBox™ Plastic Box Frame	B	10	10	\$2.30
<b>PROPLATE™</b>					
699-FC	Chrome-Plated Escutcheon For ProPlate™ - Fire-Rated ABS, 1/Bag	BI	10	200	\$7.28
699RF	White Escutcheon For ProPlate™ - Paintable, Fire-Rated ABS	B	10	10	\$2.07
<b>OMNIPANEL™</b>					
698-EX	OmniPanel™ Frame Extension	B	10	10	\$3.44
698-F	OmniPanel™ Frame	B	10	10	\$2.90
698RF	Finish Kit - Includes Fire-Rated Frame, Hole-Insert Strips, And Frame Extension	BI	10	10	\$12.05

### Box Clips, Brackets & Supports

Item Number	Item Description	Pkg Type	Min Qty	Case Qty	Price
<b>NYLON CAPS</b>					
688-C0B	1/4" Nylon Comp. Thread Cap, 10/Bag	BI	1	10	\$5.56
688-C1B	3/8" Nylon Comp. Thread Cap, 25/Bag	BI	1	4	\$6.67
<b>CAPS - LEADED</b>					
696-C3	3/4" Brass Hose Thread Cap, 2/Bag	BI	10	10	\$4.96
<b>NUTS</b>					
696-PN	1/2" Plastic Shank Nut	B	50	50	\$0.36
<b>CLIPS</b>					
696-BC	Box Clip	B	10	10	\$2.96
698-VC	Valve Clip Blue/Red, 1/Bag	B	50	50	\$1.04
<b>SUPPORT BRACKET</b>					
520-09	Sliding Support Bracket	B	250	250	\$2.41

### Secondary Drainage Funnel

Item Number	Item Description	Pkg Type	Min Qty	Case Qty	Price
696-CF	Secondary Drainage Funnel	BI	10	10	\$7.69



Access Tools

Item Number	Item Description	Pkg Type	Min Qty	Case Qty	Price
305-RT	Valve Grommet Removal Tool For Access Products	Bl	1	10	\$6.54

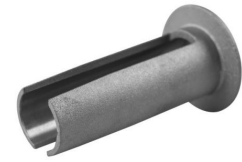

305-RT

Supply

Drainage

Support

Specialties

Appendix



# Panels

**Plastic - One-Piece**

**Plastic - Two-Piece**

**OverUnder™**

**Metal - Two-Piece**

One and two piece panels provide inconspicuous access to valves and other plumbing fixtures inside wall cavities.

The unique OverUnder™ panel can be installed during rough-in, or retrofit anytime after drywall installation.

Plastic panels can be painted or wall-papered to match wall finish.

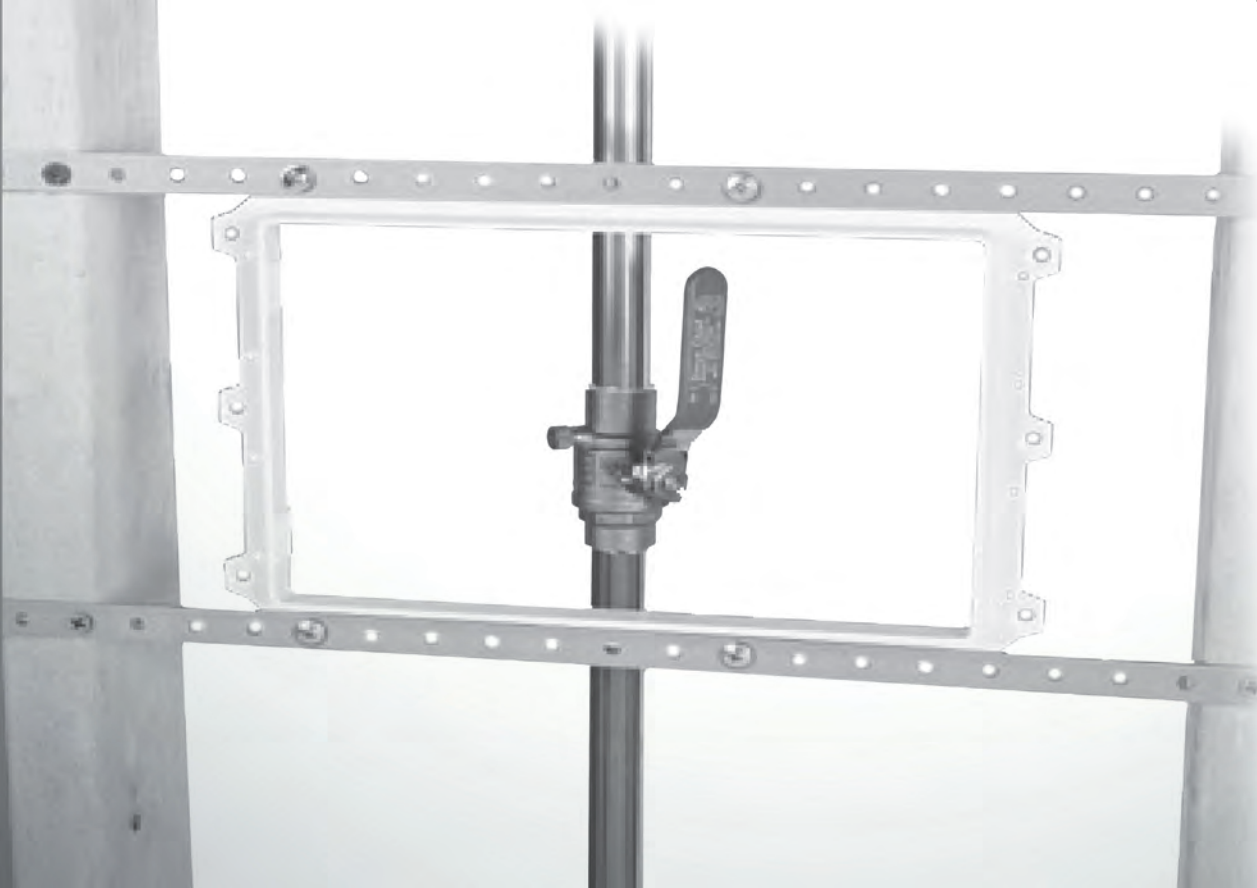



**Plastic Access Panel**

**One-Piece**

Item Number	Item Description	Pkg Type	Min Qty	Case Qty	Price
970-112	12" × 12", White ABS	BI	20	20	\$9.24
970-117	17" × 17", Polystyrene	BI	12	12	\$17.95



970-112

**Plastic Access Panel**

**Two-Piece**

Item Number	Item Description	Pkg Type	Min Qty	Case Qty	Price
970-208	Outside - 10-1/4" × 10-1/4", Inside - 8" × 8", White ABS	BI	1	12	\$34.29
970-214	Outside - 17" × 17", Inside - 14" × 14", White ABS	BI	1	12	\$40.81



970-208

**OverUnder™ Access Panel**

**Two-Piece**

Item Number	Item Description	Pkg Type	Min Qty	Case Qty	Price
970-214S	Outside - 16-1/2" × 16-1/2", Inside - 14" × 14", Polystyrene	BI	1	6	\$36.65
970-269S	Outside - 8-1/2" × 11-1/2", Inside - 6" × 9", Polystyrene	BI	1	6	\$30.14



970-214S

**Metal Access Panel**

**Two-Piece**

Item Number	Item Description	Pkg Type	Min Qty	Case Qty	Price
<b>HINGED</b>					
971-1414	Outside - 15-1/4" × 15-1/4", Inside - 14" × 14", Painted Steel	B	1	1	\$134.87
971-1430	Outside - 15-1/4" × 31-1/4", Inside - 14" × 30", Painted Steel	B	1	1	\$172.46
<b>NON-HINGED</b>					
971-77	7" × 7", Metal	B	1	1	\$793.00
971-99	9" × 9", Metal	B	1	8	\$1,161.00



971-1414



971-99

Supply

Drainage

Support

Specialties

Appendix



# **RoughUp<sup>TM</sup> Kits**

**ShowerUp<sup>TM</sup> Kits**

**HeatUp<sup>TM</sup> Kits**

# RoughUp™ Kits - Featuring Preformed Copper

## Features & Benefits

**Reduces Cost.** Preformed fittings combine multiple products into one solution. These products reduce labor and material investments to save the plumber money and time.

**Expedites Bidding.** Preformed copper items transition a contractor's variable costs into a fixed cost. Estimating jobs is easier due to better materials management and controlled waste.

**Simplifies Stocking.** Preformed copper combines multiple items into single products. Kits are treated as single SKUs for more efficient inventory management. Grab one SKU and go.

**Reduces Noise.** Increased radius bends on preformed products improve the flow characteristics of the application over traditional products. Preformed copper tub drops eliminate 'water stacking' in showers. The larger radius also reduces the noise produced by typical installations.

**Quality Engineering.** Sioux Chief preformed copper fitting ends are engineered and made in the USA, using precision manufacturing techniques. All fitting bends and ends are made to appropriate ASTM standards, compliant to nationally recognized plumbing codes and guaranteed with one of the industry's leading limited lifetime warranties.

**Standardized Layouts.** Reduce the guesswork. Each job, each unit has consistent, repeatable looks, time, materials, and quality.

**Quality Materials.** Sioux Chief utilizes only the best partners, who deliver the highest grades of material to manufacture preformed copper components. Copper is naturally lead-free, dezincification resistant, cost effective, and antimicrobial. It provides the perfect code-compliant solution for any plumbing transition, fitting, or wall termination..

**Variety.** Sioux Chief has countless preformed copper and fitting capabilities. These capabilities offer endless options and solutions.

**Reduces Risk.** Preformed copper reduces fittings for fewer joints. Fewer joints reduce the chances for leaks and reduces liability. Eliminating solder joints can mean removing the torch from the job site. Cheapest insurance there is. Peace-of-Mind

**Professional-Looking.** Preformed product can be used to improve the look of a job and become a "calling card" to help plumbers win bids.

### Male Sweat Fittings



All Sioux Chief male sweat fittings are compatible with press-fit systems and all push fit systems. Do not use push fittings with nickel-plated stub outs.

### Lead-Free Compliant



Products indicated as Lead-Free comply with NSF-61 & 372 and with the California No Lead Plumbing Law.

### FGG/BM/CZ Compatible



All CPVC connections have been tested to assure chemical compatibility with FlowGuard Gold®, BlazeMaster®, and Corzan® pipe and fittings.

\*Are registered trademarks of Lubrizol Corporation.



# Custom ShowerUp™ Kits

Build-Your-Own Kit

Use the following steps to build a kit, using the codes from the following pages

### 1. Start with the ShowerUp™ kit prefix:

Kit Prefix: 693

### 2. Choose a kit code for each component:

- A Tub Spout Elbow
- B Supply Connectors
- C Shower Riser
- D Brackets

### 3. Use this format to build your kit:

Kit Prefix	A Tub Spout Elbow	B Supply Connectors	C Shower Riser	D Bracket Option
693-	00	00	00	00

### 4. Example Item Creation:

Kit Components	Kit Prefix	A Tub Spout Elbow	B Supply Connectors	C Shower Riser	D Bracket Option
Kit Code	693-	13	03	23	03
Description		1/2" MSWT 8" x 7"	6" x 2-1/4" MSWT x CPVC (2 connectors)	1/2" FSWT x 1/2" FIP drop-ear 90	2 Power Bars, 3 TD clamps, 10 screws

Custom Kit Number: **693-13032303**

Custom Kit Price is the total for each component, added up. Kits are individually bagged, 12 kits/box. Minimum qty. = 12 kits.

### The Shower WallNut™



The ShowerUp™ system allows the use of a copper stub out elbow riser in conjunction with a Shower WallNut™ shower arm adapter. The Shower WallNut makes the shower arm connection outside the finished wall, so there are no hidden leaks. When a copper stub out elbow shower riser is used, Sioux Chief requires the use of the Shower WallNut system, including a StrongArm bracket with Shower WallNut LockBlock, and the Shower WallNut adapter. A properly installed Shower WallNut system carries a Limited Lifetime Warranty.

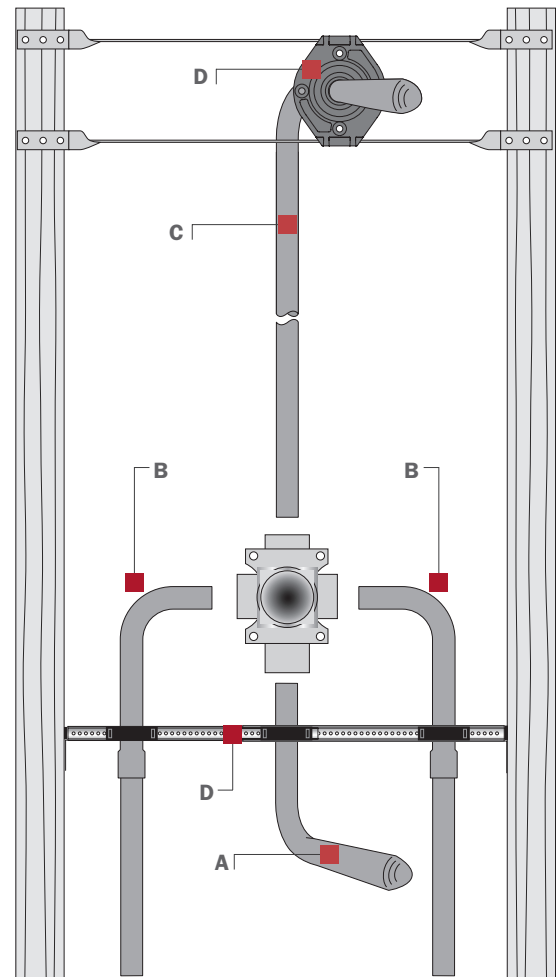

- Supply
- Drainage
- Support
- Specialties
- Appendix

Supply

Drainage

Support

Specialties

Appendix



Kit Code: 16  
613-107

## A Tub Spout Elbow

### 1/2" Male Sweat Connection

Kit Code	Item No	Description	Lead Free
01	-	None (for shower only)	x
11	613-57	5" x 7"	x
12	613-67	6" x 7"	x
13	613-87	8" x 7"	x
14	613-137	13" x 7"	x
15	613-139	13" x 9"	x
16	613-107	10" x 7"	x
17	622-L03	1/2" x 3" Straight Stub Out	x

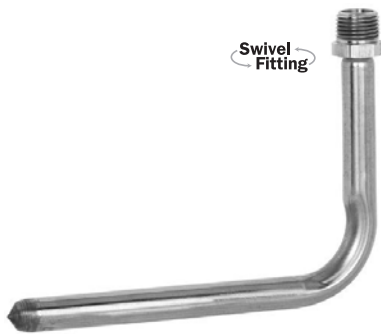

Kit Code: 02  
613-57X

### 1/2" MIP Connection

Kit Code	Item No	Description	Lead Free
02	613-57X	5" x 7", Swivel	
03	613-67X	6" x 7", Swivel	
04	613-87X	8" x 7", Swivel	
05	613-57M	5" x 7", Fixed	x
06	613-67M	6" x 7", Fixed	x
07	613-87M	8" x 7", Fixed	x



Kit Code: 31  
613-57Y

### 1/2" FIP Connection

Kit Code	Item No	Description	Lead Free
31	613-57Y	5" x 7", Swivel	x
32	613-67Y	6" x 7", Swivel	x
33	613-87Y	8" x 7", Swivel	x

**DO NOT** use pipe dope on FIP threads

## B Supply Connectors

### F1807 PEX Connection

Kit Code	Item No	Description	Lead Free
<b>SWEAT × F1807 PEX</b>			
14	632X243	4" × 2-1/4" MSWT × F1807 PEX	x
15	632X263	6" × 2-1/4" MSWT × F1807 PEX	x
16	632X222	1-5/8" × 1-1/2" MSWT × F1807 PEX	x
18	632X283	8" × 2-1/4" MSWT × F1807 PEX	x
63	660-TSX	MiniRester 1/2" MSWT Branch × 1/2" F1807 PEX	x
<b>MIP × F1807 PEX</b>			
11	646XG2	1/2" MIP × 1/2" F1807 PEX	x
12	632X263X	6" × 3" MIP Swivel × F1807 PEX	
<b>FIP × F1807 PEX</b>			
51	647XG2	1/2" FIP × 1/2" F1807 PEX	x
52	632X263Y	6" × 3" FIP Swivel × F1807 PEX	x

DO NOT use pipe dope on FIP swivel threads



Supply

Drainage

Support

Specialties

Appendix

### F1960 PEX Connection

Kit Code	Item No	Description	Lead Free
<b>SWEAT × F1960 PEX</b>			
75	632WG263	6" × 2-1/4" MSWT × 1/2" F1960 PEX	x
<b>MIP × F1960 PEX</b>			
72	632W273X	7" × 3" MIP Swivel × F1960 PEX	
<b>FIP × F1960 PEX</b>			
76	632WG263Y	6" × 3" FIP Swivel × 1/2" F1960 PEX	x

DO NOT use pipe dope on FIP swivel threads

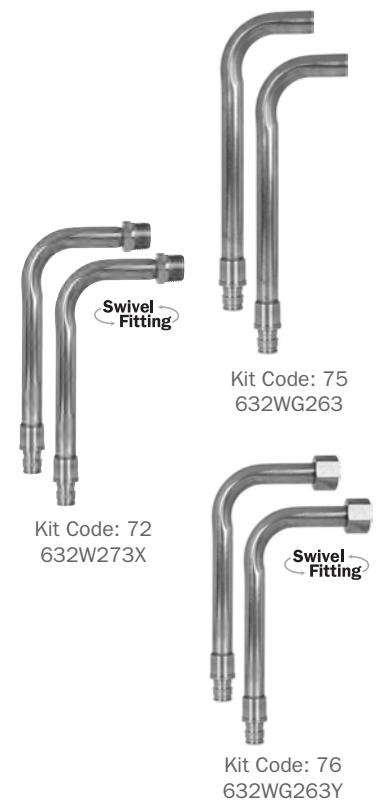

## B Supply Connectors

Supply

Drainage

Support

Specialties

Appendix



Kit Code 81  
632V273



Kit Code 03  
632-C263

Kit Code 41  
637-C20

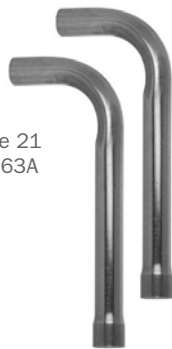

Kit Code 21  
609-L263A

### F3347 PEX Connection

Kit Code	Item No	Description	Lead Free
<b>SWEAT × F3347 PEX</b>			
81	632V273	7" × 2-1/4" MSWT × 1/2" F3347 PEX	x

### CPVC Connection

Kit Code	Item No	Description	Lead Free
<b>SWEAT × CPVC</b>			
03	632-C263	6" × 2-1/4" MSWT × CPVC	x
04	632-C283	8" × 2-1/4" MSWT × CPVC	x
<b>MIP × CPVC</b>			
01	646-CG2	1/2" MIP × 1/2" CPVC	x
02	632-C263X	6" × 3" MIP Swivel × CPVC	
<b>FIP × CPVC</b>			
41	637-C20	1/2" FIP Swivel × 1/2" CPVC	x
42	647-CG2	1/2" FIP × 1/2" CPVC	x

**DO NOT** use pipe dope on FIP swivel threads

### Sweat Connection

Kit Code	Item No	Description	Lead Free
<b>SWEAT × SWEAT</b>			
26	608-L263A	2-1/4" × 6" MSWT × 1/2" MSWT	x
61	660-TS	MiniRester 1/2" MSWT Branch × 1/2" FSWT	x
21	609-L263A	6" × 2-1/4" MSWT × FSWT	x

# C Shower Riser

## F1807 PEX Connection

Kit Code	Item No	Description	Lead Free
<b>SWEAT × F1807 PEX</b>			
17	643X2 630X248	1/2" MSWT × 1/2" F1807 PEX Adapter 4" × 8" F1807 PEX Stub Out Elbow	x
18	643X2 630X248E	1/2" MSWT × 1/2" F1807 PEX Adapter 4" × 8" F1807 PEX Stub Out Elbow with Ear Strap	x
19	643X2 647XG2E3	1/2" MSWT × 1/2" F1807 PEX Adapter 1/2" F1807 PEX × 1/2" FIP Drop-Ear 90	x
<b>MIP × F1807 PEX</b>			
11	646XG2 647X2E	1/2" MIP × 1/2" F1807 PEX Adapter 1/2" PEX × 1/2" FSWT Drop-Ear 90	x
12	646XG2 630X248	1/2" MIP × 1/2" PEX F1807 Adapter 4" × 8" F1807 PEX Stub Out Elbow	x
13	646XG2 630X248E	1/2" MIP × 1/2" PEX F1807 Adapter 4" × 8" F1807 PEX Stub Out Elbow with Ear Strap	x
<b>FIP × F1807 PEX</b>			
14	647XG2 647XG2E3	1/2" FIP × 1/2" F1807 PEX Adapter 1/2" F1807 PEX × 1/2" FSWT Drop-Ear 90	x
15	647XG2 630X248	1/2" FIP × 1/2" F1807 PEX Adapter 4" × 8" F1807 PEX Stub Out Elbow	x
16	647XG2 630X248E	1/2" FIP × 1/2" F1807 PEX Adapter 4" × 8" F1807 PEX Stub Out Elbow with Ear Strap	x



## F1960 PEX Connection

Kit Code	Item No	Description	Lead Free
<b>SWEAT × F1960 PEX</b>			
82	630WG248 643WG2	4" × 8" F1960 PEX Stub Out Elbow 1/2" MSWT × 1/2" F1960 PEX Adapter	x
91	647WG2E3 643WG2	1/2" F1960 PEX × 1/2" FIP Drop-Ear 90 1/2" MSWT × 1/2" F1960 PEX Adapter	x
<b>MIP × F1960 PEX</b>			
81	630WG248 646WG2	4" × 8" F1960 PEX Stub Out Elbow 1/2" MIP × 1/2" F1960 PEX Adapter	x
92	647WG2E3 646WG2	1/2" F1960 PEX × 1/2" FIP Drop-Ear 90 1/2" MIP × 1/2" F1960 PEX Adapter	x
<b>FIP × F1960 PEX</b>			
83	630WG248 647WG2	4" × 8" F1960 PEX Stub Out Elbow 1/2" FIP × 1/2" F1960 PEX Adapter	x
84	647WG2E3 647WG2	1/2" F1960 PEX × 1/2" FIP Drop-Ear 90 1/2" FIP × 1/2" F1960 PEX Adapter	x



Supply

Drainage

Support

Specialties

Appendix

# C Shower Riser

## CPVC Connection

Kit Code	Item No	Description	Lead Free
<b>MIP × CPVC</b>			
02	646-CG2 630-C248	1/2" MIP × 1/2" CPVC 4" × 8" CPVC Stub Out Elbow	x
03	646-CG2 630-C248E	1/2" MIP × 1/2" CPVC 4" × 8" CPVC Stub Out Elbow with Ear Strap	x
04	646-CG2 647-CG2E3	1/2" MIP × 1/2" CPVC 1/2" CPVC Drop-Ear 90	x
<b>FIP × CPVC</b>			
05	637-C20 647-CG2E3	1/2" FIP Swivel × 1/2" CPVC 1/2" CPVC Drop-Ear 90	x
06	637-C20 630-C248	1/2" FIP Swivel × 1/2" CPVC 4" × 8" CPVC Stub Out Elbow	x
07	637-C20 630-C248E	1/2" FIP Swivel × 1/2" CPVC 4" × 8" CPVC Stub Out Elbow with Ear Strap	x
08	647-CG2 647-CG2E3	1/2" FIP × 1/2" CPVC 1/2" CPVC Drop-Ear 90	x

**DO NOT** use pipe dope on FIP swivel threads

## Full-Length Copper

Kit Code	Item No	Description	Lead Free
<b>SWEAT</b>			
31	616-630	1/2" MSWT × Drop-Ear 90, 30"	
32	616-650	1/2" MSWT × Drop-Ear 90, 50"	
51	608-L2308	1/2" MSWT × Closed, 30" × 8" Stub Out Elbow	x
53	608-L2508	1/2" MSWT × Closed, 50" × 8" Stub Out Elbow	x
54	608-L2508E	1/2" MSWT × Closed, 50" × 8" Stub Out Elbow with Ear Strap	x
<b>MIP</b>			
41	616-630X	1/2" MIP swivel × Drop-Ear 90, 30"	
42	616-650X	1/2" MIP swivel × Drop-Ear 90, 50"	
<b>FIP</b>			
43	616-630Y	1/2" FIP swivel × Drop-Ear 90, 30"	
44	616-650Y	1/2" FIP swivel × Drop-Ear 90, 50"	

**DO NOT** use pipe dope on FIP swivel threads

Supply

Drainage

Support

Specialties

Appendix

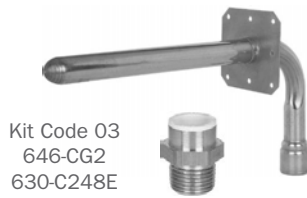

# C Shower Riser

## Sweat Connection

Kit Code	Item No	Description	Lead Free
<b>SWEAT</b>			
21	609-L248	1/2" FSWT x Closed, 4" x 8" Stub Out Elbow	x
22	609-L248E	1/2" FSWT x Closed 4" x 8" Stub Out Elbow with Ear Strap	x
23	616-2E3	1/2" FSWT x 1/2" FIP Drop-Ear 90	



# D Brackets

**Note:** When a copper stub out elbow shower riser is used, Sioux Chief requires the use of the Shower WallNut system, including a StrongArm bracket with Shower WallNut LockBlock, and the Shower WallNut adapter.

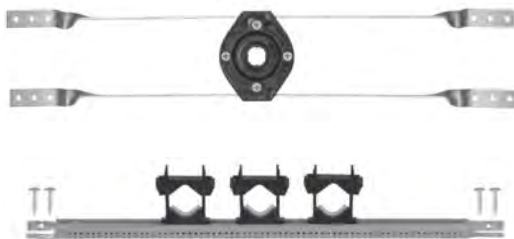

Kit Code 01  
525-16WLB  
523-2434



Kit Code 03  
523-2404  
523-2434

Kit Code	Item No	Description
01	525-16WLB 523-2434	StrongArm, 16", with 1 Shower WallNut LockBlock, 4 Screws PowerBar, 3 TouchDown Clamps, 4 Screws
02	523-2404 523-2424	PowerBar, 6 Screws PowerBar, 2 TouchDown Clamps, 4 Screws
03	523-2404 523-2434	PowerBar, 6 Screws PowerBar, 3 TouchDown Clamps, 4 screws
04	525-16WLB 523-2424	StrongArm, 16", with 1 Shower WallNut LockBlock, 4 Screws PowerBar, 2 TouchDown Clamps, 4 Screws

# Custom HeatUp™ Kits

Build-Your-Own Kit

Use the following steps to build a kit, using the codes from the following pages

### 1. Start with the HeatUp™ kit prefix:

Kit Prefix: 694

### 2. Choose a kit code for each component:

- A Hot-Side Connector
- B Cold-Side Connector
- C Expansion Tank Option

### 3. Use this format to build your kit:

Kit Prefix	A Hot-Side Connector	B Cold-Side Connector	C Expansion Tank Option
694	00	00	00

### 4. Example Item Creation:

Kit Components	Kit Prefix	A Hot-Side Connector	B Cold-Side Connector	C Expansion Tank Option
Kit Code	694	CG33	0120	91
Description		¾" FIP Swivel x ¾" CPVC Socket	¾" FIP Swivel x ¾" CPVC Socket, with Ball Valve	¾" x ¾" FIP Swivel with ¾" MIP Branch

New Custom Kit Number: **694CG33012091**

Custom Kit Price is the total for each component, added up. Kits are individually bagged, 10 kits/box. Minimum qty. = 10 kits.  
Note: Please include a \$2.00 kitting charge for all custom HeatUp™ kits.

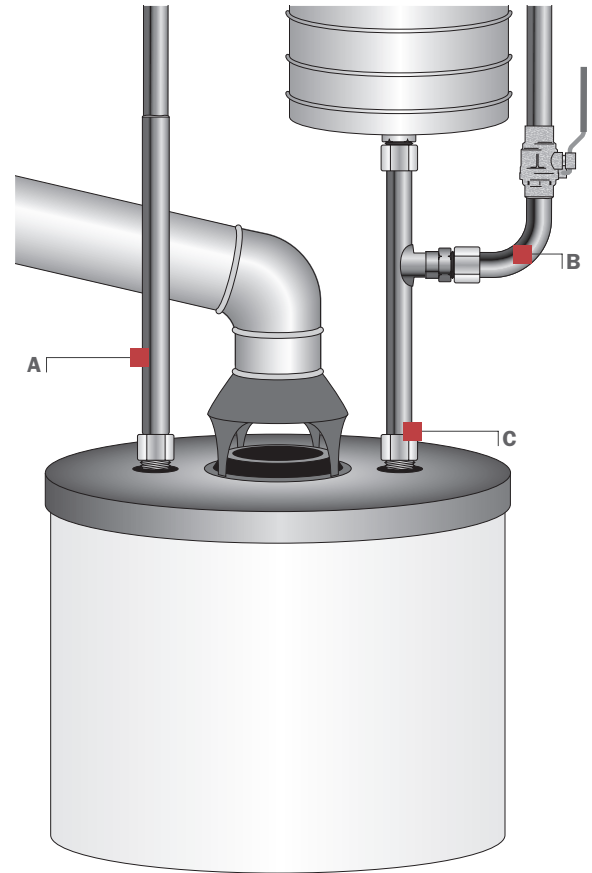

### Male Sweat Fittings



All Sioux Chief male sweat, preformed copper fittings are compatible with press-fit systems and all push fit systems. Do not use push fittings with nickel-plated stub outs.

### Lead-Free Compliant



Products indicated as Lead-Free comply with NSF-61 & 372 and with the California No Lead Plumbing Law.

### FGG/BM/CZ Compatible



All CPVC connections have been tested to assure chemical compatibility with FlowGuard Gold®, BlazeMaster®, and Corzan® pipe and fittings.  
\*Are registered trademarks of Lubrizol Corporation.



# A Hot Side Connection

## F1807 PEX Connection

Kit Code	Item No	Description	Length	Lead Free
XG06	631X02	3/4" F1807 PEX × 3/4" FIP Swivel Elbow	3" × 4½"	x
XG31	633X02	3/4" F1807 PEX × 3/4" FIP Swivel	2"	x
XG32	633X18	3/4" F1807 PEX × 3/4" FIP Swivel	18"	x
XG46	634X418	3/4" F1807 PEX × 3/4" FIP Swivel Flexible	18"	x
XG61	646XG3	3/4" F1807 PEX × 3/4" MIP	-	x

**DO NOT** use pipe dope on FIP swivel threads  
**DO NOT** twist, kink, or loop flexible connectors



## F1960 PEX Connection

Kit Code	Item No	Description	Length	Lead Free
WG71	633WG18	3/4" F1960 PEX × 3/4" FIP Swivel	18"	x
WG49	634WG418	3/4" F1960 PEX × 3/4" FIP Swivel Flexible	18"	x
WG61	631WG02	3/4" F1960 PEX × 3/4" FIP Swivel Elbow	3" × 4"	x

**DO NOT** use pipe dope on FIP swivel threads  
**DO NOT** twist, kink, or loop flexible connectors



## F3347 PEX Connection

Kit Code	Item No	Description	Length	Lead Free
VG72	633VG18	3/4" F3347 PEX × 3/4" FIP Swivel	18"	x

**DO NOT** use pipe dope on FIP swivel threads



## A Hot Side Connection

### CPVC Connection



Kit Code CG72  
646-CG318

Kit Code	Item No	Description	Length	Lead Free
CG06	631-C307	3/4" FIP Swivel × 3/4" CPVC Socket Elbow	3" × 7"	x
CG31	633-C02	3/4" FIP Swivel × 3/4" CPVC Socket	3"	x
CG32	633-C09	3/4" FIP Swivel × 3/4" CPVC Socket	9"	x
CG33	633-C18	3/4" FIP Swivel × 3/4" CPVC Socket	18"	x
CG35	633-C24	3/4" FIP Swivel × 3/4" CPVC Socket	24"	x
CG36	633-C418	1" FIP Swivel × 3/4" CPVC Socket	18"	x
CG56	634-C118	3/4" FIP Swivel × 3/4" CPVC Socket Flexible	18"	x
CG71	646-CG3	3/4" MIP × 3/4" CPVC Socket	1-1/2"	x
CG72	646-CG318	3/4" MIP × 3/4" CPVC Socket	18"	x

**DO NOT** use pipe dope on FIP swivel threads  
**DO NOT** twist, kink, or loop flexible connectors

### Sweat Connection



Kit Code -G21  
633-312

Kit Code	Item No	Description	Length	Lead Free
-G21	633-312	3/4" FIP Swivel × 3/4" Full-Slip FSWT	12"	x
-G41	631-33F	3/4" FIP Swivel × 3/4" FSWT elbow	—	x
-G31	633-318	3/4" FIP Swivel × 3/4" MSWT	18"	x

**DO NOT** use pipe dope on FIP swivel threads

### PDQ™ Push Connection



Kit Code Q31  
633Q03

Kit Code	Item No	Description	Length	Lead Free
Q31	633Q03	3/4" FIP Swivel × 3/4" Push Fit	2"	x
Q32	633Q18	3/4" FIP Swivel × 3/4" Push Fit	18"	x
Q46	634Q418	3/4" FIP Swivel × 3/4" Push Fit Flexible	18"	x

**DO NOT** use pipe dope on FIP swivel threads

Kit Code Q46  
634Q418

# B Cold Side Connection

## F1807 PEX Connection

Kit Code	Item No	Description	Ball Valve	Length	Lead Free
0120	631XG02FP	3/4" F1807 PEX x 3/4" FIP Swivel Elbow	x	2-1/2" x 6"	x
2120	633XG18FP	3/4" F1807 PEX x 3/4" FIP Swivel	x	18"	x
2520	633XG18FPT	3/4" F1807 PEX x 3/4" FIP Swivel, with 3/4" FIP Branch	x	18"	x
4120	634XG418FP	3/4" F1807 PEX x 3/4" FIP Swivel Flexible	x	18"	x
2220	633XG18FRV	3/4" F1807 PEX x 3/4" FIP Swivel, with TERV 3/8" O.D. Compression	x	18"	x
2320	633XG18HRV	3/4" F1807 PEX x 3/4" FIP Swivel, with TERV 3/8" Hose Barb	x	18"	x
2420	633XG18XRV	3/4" F1807 PEX x 3/4" FIP Swivel, with TERV 1/2" F1807	x	18"	x

**DO NOT** use pipe dope on FIP swivel threads  
**DO NOT** twist, kink, or loop flexible connectors



Supply

Drainage

Support

Specialties

Appendix

## F1960 PEX Connections

Kit Code	Item No	Description	Ball Valve	Length	Lead Free
7520	633WG306FP	3/4" F1960 PEX x 3/4" FIP Swivel	x	6"	x
7620	633WG18FPT	3/4" F1960 PEX x 3/4" FIP Swivel, with 3/4" FIP Branch	x	18"	x
4520	634WG418FP	3/4" F1960 PEX x 3/4" FIP Swivel Flexible	x	18"	x
0220	631WG02FP	3/4" F1960 PEX x 3/4" FIP Swivel Elbow	x	7"	x
7720	633WG18FP	3/4" F1960 PEX x 3/4" FIP Swivel	x	18"	x
1720	633WG18FRV	3/4" F1960 PEX x 3/4" FIP Swivel, with TERV 3/8" O.D. Compression	x	18"	x
1820	633WG18HRV	3/4" F1960 PEX x 3/4" FIP Swivel, with TERV 3/8" Hose Barb	x	18"	x
1920	633WG18WRV	3/4" F1960 PEX x 3/4" FIP Swivel, with TERV 1/2" F1960	x	18"	x

**DO NOT** use pipe dope on FIP swivel threads  
**DO NOT** twist, kink, or loop flexible connectors



Supply

Drainage

Support

Specialties

Appendix

## B Cold Side Connection



Kit Code 4320  
634VG18FP

### F3347 PEX Connections

Kit Code	Item No	Description	Ball Valve	Length	Lead Free
4320	634VG18FP	3/4" F3347 PEX x 3/4" FIP Swivel Flexible	x	18"	x
7820	633VG18FP	3/4" F3347 PEX x 3/4" FIP Swivel	x	18"	x

**DO NOT** use pipe dope on FIP swivel threads  
**DO NOT** twist, kink, or loop flexible connectors



Kit Code 1720  
633-CG18FRV



Kit Code 5120  
634-CG118FP

### CPVC Connection

Kit Code	Item No	Description	Ball Valve	Length	Lead Free
0120	631-CG307FP	3/4" FIP Swivel x 3/4" CPVC Socket elbow	x	3" x 7"	x
1220	633-CG18FP	3/4" FIP Swivel x 3/4" CPVC Socket	x	18"	x
1420	633-CG24FP	3/4" FIP Swivel x 3/4" CPVC Socket	x	24"	x
1520	633-CG418FP	1" FIP Swivel x 3/4" CPVC Socket	x	18"	x
1720	633-CG18FRV	3/4" FIP Swivel x 3/4" CPVC Socket, with TERV 3/8" O.D. Compression	x	18"	x
1820	633-CG18HRV	3/4" FIP Swivel x 3/4" CPVC Socket, with TERV 3/8" Hose Barb	x	18"	x
2120	633-CG18FPT	3/4" FIP Swivel x 3/4" CPVC Socket, with 3/4" FIP Branch	x	18"	x
5120	634-CG118FP	3/4" FIP Swivel x 3/4" CPVC Socket Flexible	x	18"	x
6120	646-CG318FP	3/4" MIP x 3/4" CPVC Socket	x	18"	x

**DO NOT** use pipe dope on FIP swivel threads  
**DO NOT** twist, kink, or loop flexible connectors



Kit Code 2120  
633-CG18FPT



Kit Code 0120  
631-CG307FP

## B Cold Side Connection

### Sweat Connection

Kit Code	Item No	Description	Ball Valve	Length	Lead Free
1120	633-G312FP	3/4" FIP Swivel x 3/4" Full-Slip FSWT	x	12"	x
0120	631-G305FP	3/4" FIP Swivel x 3/4" FSWT Elbow	x	-	x
3520	633-G318FP	3/4" FIP Swivel x 3/4" MSWT	x	18"	x

**DO NOT** use pipe dope on FIP swivel threads



Kit Code 0120  
631-G305FP

Kit Code 1120  
633-G312FP

### PDQ™ Push Connection

Kit Code	Item No	Description	Length	Lead Free
26	633Q06FP	3/4" FIP Swivel x 3/4" Push Fit	6"	x
12	633Q18FP	3/4" FIP Swivel x 3/4" Push Fit	18"	x
41	634Q418FP	3/4" FIP Swivel x 3/4" Push Fit Flexible	18"	x

**DO NOT** use pipe dope on FIP swivel threads



Kit Code 26  
633Q06FP

Kit Code 41  
634Q418FP

## C Expansion Tank Option

Kit Code	Item No	Description	Length	Lead Free
-	-	No expansion tank	-	x
91	633-G3TM15	3/4" x 3/4" FIP Swivel with 3/4" MIP Branch	15"	x
92	633-G4TM15	1" x 3/4" FIP Swivel with 3/4" MIP Branch	15"	x
93	633-G3TM11	3/4" x 3/4" FIP Swivel with 3/4" MIP Branch	11"	x
94	633-G4TM11	1" x 3/4" FIP Swivel with 3/4" MIP Branch	11"	x

**DO NOT** use pipe dope on FIP swivel threads



Kit Code 91  
633-G3TM15

Kit Code 93  
633-G3TM11

## In-Stock Kits

Check out our other convenient kits - in stock and ready to ship



PowerPEX F1807  
Stub Out Kit

### • PowerPEX F1807 PEX Kits

- . . . in the PowerPEX Systems section
  - ShowerUp Kits
  - Stub Out Kits
  - Water Heater Connector Kits



PowerPEX F1807  
Water Heater Connector Kit

### • PowerPEX F1960 PEX Kits

- . . . in the PowerPEX Systems section
  - ShowerUp Kits
  - Stub Out Kits
  - Water Heater Connector Kits



PowerPEX F1960  
ShowerUp Kit

### • PowerPEX F3347 PEX Kits

- . . . in the PowerPEX Systems section
  - Stub Out Kits

### • CPVC Kits

- . . . in the Specialized Supply section
  - ShowerUp Kits
  - Stub Out Kits
  - Water Heater Connector Kits

### • Sweat Kits

- . . . in the Specialized Supply section
  - ShowerUp Kits
  - Water Heater Connector Kits

# **Drainage**

**Specification Drainage**

**Commercial Drainage**

**Trench Drains**

**Residential Drainage**

**Testing**

**»» Making it in America**





# **Specification Drainage**

**Floor Drains**

**Floor Sinks**

**Roof Drains**

**Cleanouts**

**Fixture Carriers**

# Specification Drainage

## Floor Drains

Adjustable and non-adjustable floor drains for on-grade and above-grade applications.  
Designed in accordance with *ASME A112.6.3 Standard for Floor and Trench Drains*.

**Note:** All floor drains installed in above-grade applications must be leak tested for watertightness according to local codes and standards. Failure to do so will void the warranty.

## Floor Sinks

Enamel-coated cast iron floor sinks designed for direct or indirect waste applications.  
Designed in accordance with *ASME A112.6.7 Standard for Sanitary Floor Sinks*.

**Note:** All floor sinks installed in above-grade applications must be leak tested for watertightness according to local codes and standards. Failure to do so will void the warranty.

## Roof Drains

Roof drain, overflow, scupper and accessory fixtures available with cast iron connections.  
Designed in accordance with *ASME A112.6.4 Standard for Roof, Deck, and Balcony Drains*.

**Note:** All roof drains must be leak tested for watertightness according to local codes and standards. Failure to do so will void the warranty.

## Cleanouts

Adjustable and non-adjustable cleanout fixtures provide access to drain lines.  
Designed in accordance with *ASME A112.36.2M Standard for Cleanouts*.

**Note:** All floor cleanouts installed in above-grade applications must be leak tested for watertightness according to local codes and standards. Failure to do so will void the warranty.

## Fixture Carriers

Floor-mounted Carriers and supports for commercial water closet and lavatory fixtures.

Designed in accordance with *ASME A112.6.1M Standard for Floor-Affixed Supports for Off-The-Floor Plumbing Fixtures for Public Use*.

# Specification Floor Drains

**FinishLine™ Floor Drains**

**FatMax™ Floor Drains**

**Above-Grade Floor Drains**

**Halo™ Floor Drains**

Sioux Chief's FinishLine™ Floor drain system is adjustable both before and AFTER the concrete pour.

The FinishLine™ virtually eliminates drains set too low or not level. Installations that are faster, easier, and more professional-looking.

**Floor Drain  
Accessories**





**832-4DNR**  
Page 237



**832-25DNR**  
Page 238



**832-6DNR**  
Page 239



**832-63DSQ**  
Page 240



**832-3SSR**  
Page 241



**833-22DNQ**  
Page 242



**833-225DSR**  
Page 243



**833-62DNQ**  
Page 245



**862-235NR**  
Page 247



**862-245SQ**  
Page 249



**862-249I**  
Page 249



**862-625NQ**  
Page 250



**862-627NRE**  
Page 251



**862-625SR**  
Page 251



**862-629I**  
Page 252



**822-2DNR**  
Page 253



**822-F3DNR**  
Page 254



**860-22I**  
Page 255



**860-Q222I**  
Page 256



**860-3SS**  
Page 257



**862-47LNRE**  
Page 258



**862-47LIN**  
Page 259

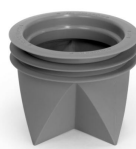

**835-3CQ**  
Page 237

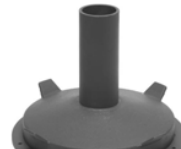

**836-2**  
Page 260



**863-FACQ**  
Page 237

Cast Iron - No-Hub Connection

6-1/2" Tops

Options: Add suffix to item no. Add price to list

V = Vandal-Resistant Strainer: \$23.00; H = Hinged Strainer (1): \$54.00;

E = Extended Ring (2): \$267.00; B = Complies with Buy American Act (2): \$211.00;

M = Medium-duty strainer (3,000 lbs. safe-load) (3): \$134.00;

1: Not available for iron strainers 2: For round nickel bronze ring/strainer only 3: For round 304 SS ring/strainer only

Item Number	Item Description	Pkg Type	Min Qty	Case Qty	Price
<b>ROUGH-IN FIXTURE</b>					
832-3DF	3" No-Hub	BI	1	5	\$270.00
832-4DF	4" No-Hub	BI	1	5	\$270.00
<b>FINISH FIXTURE</b>					
832-4DHIR	6-1/2" Rnd Ductile Iron Ring & Strainer	BI	1	10	\$290.00
832-4DHNQ	7" Sqr Nikl-Brnz Ring & Strainer	BI	1	10	\$475.00
832-4DHNR	6-1/2" Rnd Nikl-Brnz Ring & Strainer	BI	1	10	\$340.00
832-4DHSQ	7" Sqr Stnls Steel Ring & Strainer	BI	1	10	\$475.00
832-4DHSR	6-1/2" Rnd Stnls Steel Ring & Strainer	BI	1	10	\$340.00
<b>COMPLETE ASSEMBLY</b>					
832-3DIR	3" No-Hub - 6-1/2" Rnd Ductile Iron Ring & Strainer	BI	1	1	\$560.00
832-3DNQ	3" No-Hub - 7" Sqr Nikl-Brnz Ring & Strainer	BI	1	1	\$745.00
832-3DNR	3" No-Hub - 6-1/2" Rnd Nikl-Brnz Ring & Strainer	BI	1	1	\$610.00
832-3DSQ	3" No-Hub - 7" Sqr Stnls Steel Ring & Strainer	BI	1	1	\$745.00
832-3DSR	3" No-Hub - 6-1/2" Rnd Stnls Steel Ring & Strainer	BI	1	1	\$610.00
832-4DIR	4" No-Hub - 6-1/2" Rnd Ductile Iron Ring & Strainer	BI	1	1	\$560.00
832-4DNQ	4" No-Hub - 7" Sqr Nikl-Brnz Ring & Strainer	BI	1	1	\$745.00
832-4DNR	4" No-Hub - 6-1/2" Rnd Nikl-Brnz Ring & Strainer	BI	1	1	\$610.00
832-4DSQ	4" No-Hub - 7" Sqr Stnls Steel Ring & Strainer	BI	1	1	\$745.00
832-4DSR	4" No-Hub - 6-1/2" Rnd Stnls Steel Ring & Strainer	BI	1	1	\$610.00
<b>ACCESSORIES</b>					
832-EX4CQ	Ductile Iron Extension Adapter - 2" Min - 4" Max	BI	1	1	\$120.00
832-PCQ	Coring Plug Wrench	BI	1	1	\$87.00
832-S4CQ	Two Adjustment Shims, Two 3/4" Screws	BI	1	1	\$22.00
832-UMCQ	4-1/4" Stainless Steel Debris Basket	BI	1	1	\$75.00
832-WCQ	Flexible Red Locating Bristles w/ Screw	BI	1	1	\$26.00
835-3CQ	Trapshield™ For 3" Drain Outlet	BI	1	25	\$224.00
835-4CQ	Trapshield™ For 4" Drain Outlet	BI	1	20	\$265.00
863-FACQ	Round Aluminum Condensate Funnel w/ Screws	BI	1	12	\$168.00
863-FNCQ	Round Nikl-Brnz Condensate Funnel w/ Screws	BI	1	12	\$370.00
863-FNOCQ	Oval Nikl-Brnz Condensate Funnel w/ Screws	BI	1	12	\$815.00



832-3DF



Finish Fixture



832-4DNR



832-EX4CQ

Supply

Drainage

Support

Specialties

Appendix

Supply

Drainage

Support

Specialties

Appendix



832-25DF



832-3DHNQ



832-25DNR



832-PCQ

## Cast Iron - No-Hub Connection

### 5-1/2" Tops

**Options:** Add suffix to item no. Add price to list

**V** = Vandal-Resistant Strainer: \$23.00; **B** = Complies with Buy American Act (1): \$211.00;

**E** = Extended Ring (1): \$267.00;

1: For round nickel bronze ring/strainer only

Item Number	Item Description	Pkg Type	Min Qty	Case Qty	Price
<b>ROUGH-IN FIXTURE</b>					
832-25DF	2" No-Hub	BI	1	1	\$270.00
832-35DF	3" No-Hub	BI	1	1	\$270.00
<b>FINISH FIXTURE</b>					
832-3DHNQ	5-7/8" Sqr Nikl-Brnz Ring & Strainer	BI	1	1	\$360.00
832-3DHNR	5-1/2" Rnd Nikl-Brnz Ring & Strainer	BI	1	10	\$270.00
832-3DHSQ	5-7/8" Sqr Stnls Steel Ring & Strainer	BI	1	1	\$360.00
832-3DHSR	5-1/2" Rnd Stnls Steel Ring & Strainer	BI	1	1	\$270.00
<b>COMPLETE ASSEMBLY</b>					
832-25DNQ	2" No-Hub - 5-7/8" Sqr Nikl-Brnz Ring & Strainer	BI	1	1	\$630.00
832-25DNR	2" No-Hub - 5-1/2" Rnd Nikl-Brnz Ring & Strainer	BI	1	1	\$540.00
832-25DSQ	2" No-Hub - 5-7/8" Sqr Stnls Steel Ring & Strainer	BI	1	1	\$630.00
832-25DSR	2" No-Hub - 5-1/2" Rnd Stnls Steel Ring & Strainer	BI	1	1	\$540.00
832-35DNQ	3" No-Hub - 5-7/8" Sqr Nikl-Brnz Ring & Strainer	BI	1	1	\$630.00
832-35DNR	3" No-Hub - 5-1/2" Rnd Nikl-Brnz Ring & Strainer	BI	1	1	\$540.00
832-35DSQ	3" No-Hub - 5-7/8" Sqr Stnls Steel Ring & Strainer	BI	1	1	\$630.00
832-35DSR	3" No-Hub - 5-1/2" Rnd Stnls Steel Ring & Strainer	BI	1	1	\$540.00
<b>ACCESSORIES</b>					
832-EX3CQ	Ductile Iron Extension Adapter - 2" Min - 3-3/8" Max	BI	1	1	\$120.00
832-PCQ	Coring Plug Wrench	BI	1	1	\$87.00
832-S3CQ	Two Adjustment Shims, Two 3/4" Screws	BI	1	1	\$22.00
832-WCQ	Flexible Red Locating Bristles w/ Screw	BI	1	1	\$26.00
835-2CQ	Trapshield™ For 2" Drain Outlet	BI	1	50	\$199.00
835-3CQ	Trapshield™ For 3" Drain Outlet	BI	1	25	\$224.00
863-FACQ	Round Aluminum Condensate Funnel w/ Screws	BI	1	12	\$168.00
863-FNCQ	Round Nikl-Brnz Condensate Funnel w/ Screws	BI	1	12	\$370.00
863-FNOCQ	Oval Nikl-Brnz Condensate Funnel w/ Screws	BI	1	12	\$815.00

**Cast Iron - No-Hub Connection**

**9" Tops**

**Options:** Add suffix to item no. Add price to list  
**V** = Vandal-Resistant Strainer: \$23.00; **C** = Clamping Collar: \$149.00;

Item Number	Item Description	Pkg Type	Min Qty	Case Qty	Price
<b>ROUGH-IN FIXTURE</b>					
832-49DF	4" No-Hub	BI	1	1	\$530.00
832-6DF	6" No-Hub	BI	1	1	\$530.00
<b>FINISH FIXTURE</b>					
832-6DHNR	9" Rnd Nikl-Brnz Ring & Strainer	BI	1	1	\$700.00
832-6DHSR	9" Rnd Stnls Steel Ring & Strainer	BI	1	1	\$700.00
<b>COMPLETE ASSEMBLY</b>					
832-49DNR	4" No-Hub - 9" Rnd Nikl-Brnz Ring & Strainer	BI	1	1	\$1,230.00
832-49DSR	4" No-Hub - 9" Rnd Stnls Steel Ring & Strainer	BI	1	1	\$1,230.00
832-6DNR	6" No-Hub - 9" Rnd Nikl-Brnz Ring & Strainer	BI	1	1	\$1,230.00
832-6DSR	6" No-Hub - 9" Rnd Stnls Steel Ring & Strainer	BI	1	1	\$1,230.00
<b>ACCESSORIES</b>					
832-PCQ	Coring Plug Wrench	BI	1	1	\$87.00
832-SD9	Ductile iron strainer - sets inside Coring Sleeve. Use in place of Finish Fixture	BI	1	1	\$306.00
832-WCQ	Flexible Red Locating Bristles w/ Screw	BI	1	1	\$26.00
835-4CQ	Trapshield™ For 4" Drain Outlet	BI	1	20	\$265.00
863-FACQ	Round Aluminum Condensate Funnel w/ Screws	BI	1	12	\$168.00
863-FNCQ	Round Nikl-Brnz Condensate Funnel w/ Screws	BI	1	12	\$370.00
863-FNOCQ	Oval Nikl-Brnz Condensate Funnel w/ Screws	BI	1	12	\$815.00



832-6DF



832-6DHNR



832-49DSR



832-WCQ

**Cast Iron - Push-Joint Connection**

**6-1/2" Tops**

**Options:** Add suffix to item no. Add price to list  
**V** = Vandal-Resistant Strainer: \$23.00; **H** = Hinged Strainer (1): \$54.00;  
**E** = Extended Ring (2): \$267.00; **B** = Complies with Buy American Act (2): \$211.00;  
**M** = Medium-duty strainer (3,000 lbs. safe-load) (3): \$134.00; **P** = Push-joint gasket to fit Sch. 40 ABS/PVC pipe: \$25.00;

1: Not available for iron strainers 2: For round nickel bronze ring/strainer only 3: For round 304 SS ring/strainer only

Item Number	Item Description	Pkg Type	Min Qty	Case Qty	Price
<b>ROUGH-IN FIXTURE</b>					
832-63DF	3" PJ Conn.	BI	1	1	\$270.00
832-64DF	4" PJ Conn.	BI	1	1	\$270.00



832-63DF

Supply

Drainage

Support

Specialties

Appendix

**Cast Iron - Push-Joint Connection (Cont)**

**6-1/2" Tops**



832-4DHNQ



832-63DSQ



832-S4CQ

Item Number	Item Description	Pkg Type	Min Qty	Case Qty	Price
<b>FINISH FIXTURE</b>					
832-4DHIR	6-1/2" Rnd Ductile Iron Ring & Strainer	BI	1	10	\$290.00
832-4DHNQ	7" Sqr Nikl-Brnz Ring & Strainer	BI	1	10	\$475.00
832-4DHNR	6-1/2" Rnd Nikl-Brnz Ring & Strainer	BI	1	10	\$340.00
832-4DHSQ	7" Sqr Stnls Steel Ring & Strainer	BI	1	10	\$475.00
832-4DHSR	6-1/2" Rnd Stnls Steel Ring & Strainer	BI	1	10	\$340.00
<b>COMPLETE ASSEMBLY</b>					
<b>832-63DIR</b>	3" PJ Conn. - 6-1/2" Rnd Ductile Iron Ring & Strainer	BI	1	1	\$560.00
832-63DNQ	3" PJ Conn. - 7" Sqr Nikl-Brnz Ring & Strainer	BI	1	1	\$745.00
832-63DNR	3" PJ Conn. - 6-1/2" Rnd Nikl-Brnz Ring & Strainer	BI	1	1	\$610.00
<b>832-63DSQ</b>	3" PJ Conn. - 7" Sqr Stnls Steel Ring & Strainer	BI	1	1	\$745.00
<b>832-63DSR</b>	3" PJ Conn. - 6-1/2" Rnd Stnls Steel Ring & Strainer	BI	1	1	\$610.00
832-64DIR	4" PJ Conn. - 6-1/2" Rnd Ductile Iron Ring & Strainer	BI	1	1	\$560.00
<b>832-64DNQ</b>	4" PJ Conn. - 7" Sqr Nikl-Brnz Ring & Strainer	BI	1	1	\$745.00
832-64DNR	4" PJ Conn. - 6-1/2" Rnd Nikl-Brnz Ring & Strainer	BI	1	1	\$610.00
<b>832-64DSQ</b>	4" PJ Conn. - 7" Sqr Stnls Steel Ring & Strainer	BI	1	1	\$745.00
<b>832-64DSR</b>	4" PJ Conn. - 6-1/2" Rnd Stnls Steel Ring & Strainer	BI	1	1	\$610.00
<b>ACCESSORIES</b>					
<b>832-EX4CQ</b>	Ductile Iron Extension Adapter - 2" Min - 4" Max	BI	1	1	\$120.00
<b>832-PCQ</b>	Coring Plug Wrench	BI	1	1	\$87.00
<b>832-S4CQ</b>	Two Adjustment Shims, Two 3/4" Screws	BI	1	1	\$22.00
<b>832-UMCQ</b>	4-1/4" Stainless Steel Debris Basket	BI	1	1	\$75.00
<b>832-WCQ</b>	Flexible Red Locating Bristles w/ Screw	BI	1	1	\$26.00
<b>835-3CQ</b>	Trapshield™ For 3" Drain Outlet	BI	1	25	\$224.00
<b>835-4CQ</b>	Trapshield™ For 4" Drain Outlet	BI	1	20	\$265.00
<b>858-PG3CQ</b>	Push-Joint Gasket For 3" Sch. 40 Pipe	BI	1	1	\$60.00
<b>858-PG4CQ</b>	Push-Joint Gasket For 4" Sch. 40 Pipe	BI	1	1	\$60.00
<b>863-FACQ</b>	Round Aluminum Condensate Funnel w/ Screws	BI	1	12	\$168.00
<b>863-FNCQ</b>	Round Nikl-Brnz Condensate Funnel w/ Screws	BI	1	12	\$370.00
<b>863-FNOCQ</b>	Oval Nikl-Brnz Condensate Funnel w/ Screws	BI	1	12	\$815.00

Supply

Drainage

Support

Specialties

Appendix



**Stainless Steel - No-Hub Connection**

**6-1/2" Tops**

**Options:** Add suffix to item no. Add price to list  
**V** = Vandal-Resistant Strainer: \$23.00; **H** = Hinged Strainer: \$54.00;  
**M** = Medium-duty strainer (3,000 lbs. safe-load) (1): \$134.00;

1: Not available for square ring/strainer

Item Number	Item Description	Pkg Type	Min Qty	Case Qty	Price
<b>ROUGH-IN FIXTURE</b>					
832-3SF	3" No-Hub	Bl	1	1	\$1,500.00
832-4SF	4" No-Hub	Bl	1	1	\$1,500.00
<b>FINISH FIXTURE</b>					
832-4SHSQ	7" Sqr Stnls Steel Ring & Strainer	Bl	1	1	\$900.00
832-4SHSR	6-1/2" Rnd Stnls Steel Ring & Strainer	Bl	1	1	\$800.00
<b>COMPLETE ASSEMBLY</b>					
832-3SSQ	3" No-Hub - 7" Sqr Stnls Steel Ring & Strainer	Bl	1	1	\$2,400.00
832-3SSR	3" No-Hub - 6-1/2" Rnd Stnls Steel Ring & Strainer	Bl	1	1	\$2,300.00
832-4SSQ	4" No-Hub - 7" Sqr Stnls Steel Ring & Strainer	Bl	1	1	\$2,400.00
832-4SSR	4" No-Hub - 6-1/2" Rnd Stnls Steel Ring & Strainer	Bl	1	1	\$2,300.00
<b>ACCESSORIES</b>					
832-PCQ	Coring Plug Wrench	Bl	1	1	\$87.00
832-S4CQ	Two Adjustment Shims, Two 3/4" Screws	Bl	1	1	\$22.00
832-UMCQ	4-1/4" Stainless Steel Debris Basket	Bl	1	1	\$75.00
832-WCQ	Flexible Red Locating Bristles w/ Screw	Bl	1	1	\$26.00
835-3CQ	Trapshield™ For 3" Drain Outlet	Bl	1	25	\$224.00
835-4CQ	Trapshield™ For 4" Drain Outlet	Bl	1	20	\$265.00
863-FACQ	Round Aluminum Condensate Funnel w/ Screws	Bl	1	12	\$168.00
863-FNCQ	Round Nikl-Brnz Condensate Funnel w/ Screws	Bl	1	12	\$370.00
863-FNOCQ	Oval Nikl-Brnz Condensate Funnel w/ Screws	Bl	1	12	\$815.00



832-4SF



832-4SHSR



832-3SSR



835-3CQ

Supply

Drainage

Support

Specialties

Appendix

Cast Iron - No-Hub Connection

6-1/2" Tops

Options: Add suffix to item no. Add price to list

V = Vandal-Resistant Strainer: \$23.00; H = Hinged Strainer (1): \$54.00;

E = Extended Ring (2): \$267.00; B = Complies with Buy American Act (2): \$211.00;

M = Medium-duty strainer (3,000 lbs safe-load) (3): \$134.00;

1: Not available for iron strainers 2: For round nickel bronze ring/strainer only 3: For round 304 SS ring/strainer only



833-22DF



832-4DHIR



833-22DNQ

Item Number	Item Description	Pkg Type	Min Qty	Case Qty	Price
<b>ROUGH-IN FIXTURE</b>					
833-22DF	2" No-Hub	BI	1	1	\$370.00
833-23DF	3" No-Hub	BI	1	1	\$370.00
833-24DF	4" No-Hub	BI	1	1	\$370.00
<b>FINISH FIXTURE</b>					
832-4DHIR	6-1/2" Rnd Ductile Iron Ring & Strainer	BI	1	10	\$290.00
832-4DHNQ	7" Sqr Nikl-Brmz Ring & Strainer	BI	1	10	\$475.00
832-4DHNH	6-1/2" Rnd Nikl-Brmz Ring & Strainer	BI	1	10	\$340.00
832-4DHSQ	7" Sqr Stnls Steel Ring & Strainer	BI	1	10	\$475.00
832-4DHSR	6-1/2" Rnd Stnls Steel Ring & Strainer	BI	1	10	\$340.00
<b>COMPLETE ASSEMBLY</b>					
833-22DIR	2" No-Hub - 6-1/2" Rnd Ductile Iron Ring & Strainer	BI	1	1	\$660.00
833-22DNQ	2" No-Hub - 7" Sqr Nikl-Brmz Ring & Strainer	BI	1	1	\$845.00
833-22DNR	2" No-Hub - 6-1/2" Rnd Nikl-Brmz Ring & Strainer	BI	1	1	\$710.00
833-22DSQ	2" No-Hub - 7" Sqr Stnls Steel Ring & Strainer	BI	1	1	\$845.00
833-22DSR	2" No-Hub - 6-1/2" Rnd Stnls Steel Ring & Strainer	BI	1	1	\$710.00
833-23DIR	3" No-Hub - 6-1/2" Rnd Ductile Iron Ring & Strainer	BI	1	1	\$660.00
833-23DNQ	3" No-Hub - 7" Sqr Nikl-Brmz Ring & Strainer	BI	1	1	\$845.00
833-23DNR	3" No-Hub - 6-1/2" Rnd Nikl-Brmz Ring & Strainer	BI	1	1	\$710.00
833-23DSQ	3" No-Hub - 7" Sqr Stnls Steel Ring & Strainer	BI	1	1	\$845.00
833-23DSR	3" No-Hub - 6-1/2" Rnd Stnls Steel Ring & Strainer	BI	1	1	\$710.00
833-24DIR	4" No-Hub - 6-1/2" Rnd Ductile Iron Ring & Strainer	BI	1	1	\$660.00
833-24DNQ	4" No-Hub - 7" Sqr Nikl-Brmz Ring & Strainer	BI	1	1	\$845.00
833-24DNR	4" No-Hub - 6-1/2" Rnd Nikl-Brmz Ring & Strainer	BI	1	1	\$710.00
833-24DSQ	4" No-Hub - 7" Sqr Stnls Steel Ring & Strainer	BI	1	1	\$845.00
833-24DSR	4" No-Hub - 6-1/2" Rnd Stnls Steel Ring & Strainer	BI	1	1	\$710.00

Supply

Drainage

Support

Specialties

Appendix

Cast Iron - No-Hub Connection (Cont)

6-1/2" Tops

Item Number	Item Description	Pkg Type	Min Qty	Case Qty	Price
<b>ACCESSORIES</b>					
832-EX4CQ	Ductile Iron Extension Adapter - 2" Min - 4" Max	BI	1	1	\$120.00
832-PCQ	Coring Plug Wrench	BI	1	1	\$87.00
832-S4CQ	Two Adjustment Shims, Two 3/4" Screws	BI	1	1	\$22.00
832-UMCQ	4-1/4" Stainless Steel Debris Basket	BI	1	1	\$75.00
832-WCQ	Flexible Red Locating Bristles w/ Screw	BI	1	1	\$26.00
835-2CQ	Trapshield™ For 2" Drain Outlet	BI	1	50	\$199.00
835-3CQ	Trapshield™ For 3" Drain Outlet	BI	1	25	\$224.00
835-4CQ	Trapshield™ For 4" Drain Outlet	BI	1	20	\$265.00
863-FACQ	Round Aluminum Condensate Funnel w/ Screws	BI	1	12	\$168.00
863-FNCQ	Round Nikl-Brnz Condensate Funnel w/ Screws	BI	1	12	\$370.00
863-FNOCQ	Oval Nikl-Brnz Condensate Funnel w/ Screws	BI	1	12	\$815.00



832-EX4CQ

Cast Iron - No-Hub Connection

5-1/2" Tops

**Options:** Add suffix to item no. Add price to list  
**V** = Vandal-Resistant Strainer: \$23.00; **B** = Complies with Buy American Act (1): \$211.00;  
**E** = Extended ring (1): \$267.00;

1: For round nickel bronze ring/strainer only

Item Number	Item Description	Pkg Type	Min Qty	Case Qty	Price
<b>ROUGH-IN FIXTURE</b>					
833-225DF	2" No-Hub	BI	1	1	\$370.00
833-235DF	3" No-Hub	BI	1	1	\$370.00
<b>FINISH FIXTURE</b>					
832-3DHNQ	5-7/8" Sqr Nikl-Brnz Ring & Strainer	BI	1	1	\$360.00
832-3DHNQ	5-1/2" Rnd Nikl-Brnz Ring & Strainer	BI	1	10	\$270.00
832-3DHSQ	5-7/8" Sqr Stnls Steel Ring & Strainer	BI	1	1	\$360.00
832-3DHSR	5-1/2" Rnd Stnls Steel Ring & Strainer	BI	1	1	\$270.00
<b>COMPLETE ASSEMBLY</b>					
833-225DNQ	2" No-Hub - 5-7/8" Sqr Nikl-Brnz Ring & Strainer	BI	1	1	\$730.00
833-225DNR	2" No-Hub - 5-1/2" Rnd Nikl-Brnz Ring & Strainer	BI	1	1	\$640.00
833-225DSQ	2" No-Hub - 5-7/8" Sqr Stnls Steel Ring & Strainer	BI	1	1	\$730.00
833-225DSR	2" No-Hub - 5-1/2" Rnd Stnls Steel Ring & Strainer	BI	1	1	\$640.00
833-235DNQ	3" No-Hub - 5-7/8" Sqr Nikl-Brnz Ring & Strainer	BI	1	1	\$730.00
833-235DNR	3" No-Hub - 5-1/2" Rnd Nikl-Brnz Ring & Strainer	BI	1	1	\$640.00
833-235DSQ	3" No-Hub - 5-7/8" Sqr Stnls Steel Ring & Strainer	BI	1	1	\$730.00
833-235DSR	3" No-Hub - 5-1/2" Rnd Stnls Steel Ring & Strainer	BI	1	1	\$640.00



833-225DF



832-3DHNQ



833-225DSR

Supply

Drainage

Support

Specialties

Appendix



835-3CQ

### Cast Iron - No-Hub Connection (Cont)

#### 5-1/2" Tops

Item Number	Item Description	Pkg Type	Min Qty	Case Qty	Price
<b>ACCESSORIES</b>					
832-EX3CQ	Ductile Iron Extension Adapter - 2" Min - 3-3/8" Max	BI	1	1	\$120.00
832-PCQ	Coring Plug Wrench	BI	1	1	\$87.00
832-S3CQ	Two Adjustment Shims, Two 3/4" Screws	BI	1	1	\$22.00
832-WCQ	Flexible Red Locating Bristles w/ Screw	BI	1	1	\$26.00
835-2CQ	Trapshield™ For 2" Drain Outlet	BI	1	50	\$199.00
835-3CQ	Trapshield™ For 3" Drain Outlet	BI	1	25	\$224.00
863-FACQ	Round Aluminum Condensate Funnel w/ Screws	BI	1	12	\$168.00
863-FNCQ	Round Nikl-Brnz Condensate Funnel w/ Screws	BI	1	12	\$370.00
863-FNOCQ	Oval Nikl-Brnz Condensate Funnel w/ Screws	BI	1	12	\$815.00

### Cast Iron - Push-Joint Connection

#### 6-1/2" Tops



833-62DF



832-4DHIR

**Options:** Add suffix to item no. Add price to list

**V** = Vandal-Resistant Strainer: \$23.00; **H** = Hinged Strainer (1): \$54.00;

**E** = Extended ring (2): \$267.00; **B** = Complies with Buy American Act (2): \$211.00;

**M** = Medium-duty strainer (3,000 lbs. safe-load) (3): \$134.00; **P** = Push-joint gasket to fit Sch. 40 ABS/PVC pipe (4): \$25.00;

1: Not available for iron strainers. 2: For round nickel bronze ring/strainer only 3: For round 304 SS ring/strainer only 4: Not available for 2" drains.

Item Number	Item Description	Pkg Type	Min Qty	Case Qty	Price
<b>ROUGH-IN FIXTURE</b>					
833-62DF	2" PJ Conn.	BI	1	1	\$370.00
833-63DF	3" PJ Conn.	BI	1	1	\$370.00
833-64DF	4" PJ Conn.	BI	1	1	\$370.00
<b>FINISH FIXTURE</b>					
832-4DHIR	6-1/2" Rnd Ductile Iron Ring & Strainer	BI	1	10	\$290.00
832-4DHNQ	7" Sqr Nikl-Brnz Ring & Strainer	BI	1	10	\$475.00
832-4DHNR	6-1/2" Rnd Nikl-Brnz Ring & Strainer	BI	1	10	\$340.00
832-4DHSQ	7" Sqr Stnls Steel Ring & Strainer	BI	1	10	\$475.00
832-4DHSR	6-1/2" Rnd Stnls Steel Ring & Strainer	BI	1	10	\$340.00

**Cast Iron - Push-Joint Connection (Cont)**

**6-1/2" Tops**

Item Number	Item Description	Pkg Type	Min Qty	Case Qty	Price
<b>COMPLETE ASSEMBLY</b>					
833-62DIR	2" PJ Conn. - 6-1/2" Rnd Ductile Iron Ring & Strainer	BI	1	1	\$660.00
833-62DNQ	2" PJ Conn. - 7" Sqr Nikl-Brnz Ring & Strainer	BI	1	1	\$845.00
833-62DNR	2" PJ Conn. - 6-1/2" Rnd Nikl-Brnz Ring & Strainer	BI	1	1	\$710.00
833-62DSQ	2" PJ Conn. - 7" Sqr Stnls Steel Ring & Strainer	BI	1	1	\$845.00
833-62DSR	2" PJ Conn. - 6-1/2" Rnd Stnls Steel Ring & Strainer	BI	1	1	\$710.00
833-63DIR	3" PJ Conn. - 6-1/2" Rnd Ductile Iron Ring & Strainer	BI	1	1	\$660.00
833-63DNQ	3" PJ Conn. - 7" Sqr Nikl-Brnz Ring & Strainer	BI	1	1	\$845.00
833-63DNR	3" PJ Conn. - 6-1/2" Rnd Nikl-Brnz Ring & Strainer	BI	1	1	\$710.00
833-63DSQ	3" PJ Conn. - 7" Sqr Stnls Steel Ring & Strainer	BI	1	1	\$845.00
833-63DSR	3" PJ Conn. - 6-1/2" Rnd Stnls Steel Ring & Strainer	BI	1	1	\$710.00
833-64DIR	4" PJ Conn. - 6-1/2" Rnd Ductile Iron Ring & Strainer	BI	1	1	\$660.00
833-64DNQ	4" PJ Conn. - 7" Sqr Nikl-Brnz Ring & Strainer	BI	1	1	\$845.00
833-64DNR	4" PJ Conn. - 6-1/2" Rnd Nikl-Brnz Ring & Strainer	BI	1	1	\$710.00
833-64DSQ	4" PJ Conn. - 7" Sqr Stnls Steel Ring & Strainer	BI	1	1	\$845.00
833-64DSR	4" PJ Conn. - 6-1/2" Rnd Stnls Steel Ring & Strainer	BI	1	1	\$710.00
<b>ACCESSORIES</b>					
832-EX4CQ	Ductile Iron Extension Adapter - 2" Min - 4" Max	BI	1	1	\$120.00
832-PCQ	Coring Plug Wrench	BI	1	1	\$87.00
832-S4CQ	Two Adjustment Shims, Two 3/4" Screws	BI	1	1	\$22.00
832-UMCQ	4-1/4" Stainless Steel Debris Basket	BI	1	1	\$75.00
832-WCQ	Flexible Red Locating Bristles w/ Screw	BI	1	1	\$26.00
835-2CQ	Trapshield™ For 2" Drain Outlet	BI	1	50	\$199.00
835-3CQ	Trapshield™ For 3" Drain Outlet	BI	1	25	\$224.00
835-4CQ	Trapshield™ For 4" Drain Outlet	BI	1	20	\$265.00
858-PG3CQ	Push-Joint Gasket For 3" Sch. 40 Pipe	BI	1	1	\$60.00
858-PG4CQ	Push-Joint Gasket For 4" Sch. 40 Pipe	BI	1	1	\$60.00
863-FACQ	Round Aluminum Condensate Funnel w/ Screws	BI	1	12	\$168.00
863-FNCQ	Round Nikl-Brnz Condensate Funnel w/ Screws	BI	1	12	\$370.00
863-FNOCQ	Oval Nikl-Brnz Condensate Funnel w/ Screws	BI	1	12	\$815.00



833-62DNQ



858-PG3CQ

Supply

Drainage

Support

Specialties

Appendix

**Cast Iron - Push-Joint Connection**  
**5-1/2" Tops**

**Options:** Add suffix to item no. Add price to list  
**V** = Vandal-Resistant Strainer: \$23.00; **B** = Complies with Buy American Act (1): \$211.00;  
**E** = Extended ring (1): \$267.00; **P** = Push-joint gasket to fit Sch. 40 pipe (2): \$25.00;

1: For round nickel bronze ring/strainer only 2: For 3" drains only.



833-635DF



832-3DHSR



833-625DSQ



832-EX3CQ

Item Number	Item Description	Pkg Type	Min Qty	Case Qty	Price
<b>ROUGH-IN FIXTURE</b>					
833-625DF	2" PJ Conn.	BI	1	1	\$370.00
833-635DF	3" PJ Conn.	BI	1	1	\$370.00
<b>FINISH FIXTURE</b>					
832-3DHNQ	5-7/8" Sqr Nikl-Brnz Ring & Strainer	BI	1	1	\$360.00
832-3DHNR	5-1/2" Rnd Nikl-Brnz Ring & Strainer	BI	1	10	\$270.00
832-3DHSQ	5-7/8" Sqr Stnls Steel Ring & Strainer	BI	1	1	\$360.00
832-3DHSR	5-1/2" Rnd Stnls Steel Ring & Strainer	BI	1	1	\$270.00
<b>COMPLETE ASSEMBLY</b>					
833-625DNQ	2" PJ Conn. - 5-7/8" Sqr Nikl-Brnz Ring & Strainer	BI	1	1	\$730.00
833-625DNR	2" PJ Conn. - 5-1/2" Rnd Nikl-Brnz Ring & Strainer	BI	1	1	\$640.00
833-625DSQ	2" PJ Conn. - 5-7/8" Sqr Stnls Steel Ring & Strainer	BI	1	1	\$730.00
833-625DSR	2" PJ Conn. - 5-1/2" Rnd Stnls Steel Ring & Strainer	BI	1	1	\$640.00
833-635DNQ	3" PJ Conn. - 5-7/8" Sqr Nikl-Brnz Ring & Strainer	BI	1	1	\$730.00
833-635DNR	3" PJ Conn. - 5-1/2" Rnd Nikl-Brnz Ring & Strainer	BI	1	1	\$640.00
833-635DSQ	3" PJ Conn. - 5-7/8" Sqr Stnls Steel Ring & Strainer	BI	1	1	\$730.00
833-635DSR	3" PJ Conn. - 5-1/2" Rnd Stnls Steel Ring & Strainer	BI	1	1	\$640.00
<b>ACCESSORIES</b>					
832-EX3CQ	Ductile Iron Extension Adapter - 2" Min - 3-3/8" Max	BI	1	1	\$120.00
832-PCQ	Coring Plug Wrench	BI	1	1	\$87.00
832-S3CQ	Two Adjustment Shims, Two 3/4" Screws	BI	1	1	\$22.00
832-WCQ	Flexible Red Locating Bristles w/ Screw	BI	1	1	\$26.00
835-2CQ	Trapshield™ For 2" Drain Outlet	BI	1	50	\$199.00
835-3CQ	Trapshield™ For 3" Drain Outlet	BI	1	25	\$224.00
858-PG3CQ	Push-Joint Gasket For 3" Sch. 40 Pipe	BI	1	1	\$60.00
863-FACQ	Round Aluminum Condensate Funnel w/ Screws	BI	1	12	\$168.00
863-FNCQ	Round Nikl-Brnz Condensate Funnel w/ Screws	BI	1	12	\$370.00
863-FNOCQ	Oval Nikl-Brnz Condensate Funnel w/ Screws	BI	1	12	\$815.00

Supply

Drainage

Support

Specialties

Appendix

## Cast Iron - No-Hub Connection

### Nickel-Bronze Ring & Strainer

- Nickel-bronze head/strainer for light-duty traffic
- Cast iron drain body with clamping collar

**Options:** Add suffix to item no. Add price to list

A = Acid-Resistant Epoxy Coated Cast Iron: \$275.00; B = Sediment Bucket: \$105.00;



862-235NR



862-235NQ

Item Number	Item Description	Pkg Type	Min Qty	Case Qty	Price
<b>5" ROUND STRAINER</b>					
862-225NR	2" No-Hub - 5" Nikl-Brnz Ring & Strainer	B	1	1	\$600.00
862-235NR	3" No-Hub - 5" Nikl-Brnz Ring & Strainer	B	1	1	\$600.00
862-245NR	4" No-Hub - 5" Nikl-Brnz Ring & Strainer	B	1	1	\$600.00
<b>6" ROUND STRAINER</b>					
862-226NR	2" No-Hub - 6" Nikl-Brnz Ring & Strainer	B	1	1	\$700.00
862-236NR	3" No-Hub - 6" Nikl-Brnz Ring & Strainer	B	1	1	\$700.00
862-246NR	4" No-Hub - 6" Nikl-Brnz Ring & Strainer	B	1	1	\$700.00
<b>7" ROUND STRAINER</b>					
862-227NR	2" No-Hub - 7" Nikl-Brnz Ring & Strainer	B	1	1	\$900.00
862-237NR	3" No-Hub - 7" Nikl-Brnz Ring & Strainer	B	1	1	\$900.00
862-247NR	4" No-Hub - 7" Nikl-Brnz Ring & Strainer	B	1	1	\$900.00
<b>8" ROUND STRAINER</b>					
862-228NR	2" No-Hub - 8" Nikl-Brnz Ring & Strainer	B	1	1	\$1,000.00
862-238NR	3" No-Hub - 8" Nikl-Brnz Ring & Strainer	B	1	1	\$1,000.00
862-248NR	4" No-Hub - 8" Nikl-Brnz Ring & Strainer	B	1	1	\$1,000.00
<b>10" ROUND STRAINER</b>					
862-2210NR	2" No-Hub - 10" Nikl-Brnz Ring & Strainer	B	1	1	\$1,300.00
862-2310NR	3" No-Hub - 10" Nikl-Brnz Ring & Strainer	B	1	1	\$1,300.00
862-2410NR	4" No-Hub - 10" Nikl-Brnz Ring & Strainer	B	1	1	\$1,300.00
<b>5" SQUARE STRAINER</b>					
862-225NQ	2" No-Hub - 5" Nikl-Brnz Ring & Strainer	B	1	1	\$720.00
862-235NQ	3" No-Hub - 5" Nikl-Brnz Ring & Strainer	B	1	1	\$720.00
862-245NQ	4" No-Hub - 5" Nikl-Brnz Ring & Strainer	B	1	1	\$720.00
<b>6" SQUARE STRAINER</b>					
862-226NQ	2" No-Hub - 6" Nikl-Brnz Ring & Strainer	B	1	1	\$820.00
862-236NQ	3" No-Hub - 6" Nikl-Brnz Ring & Strainer	B	1	1	\$820.00
862-246NQ	4" No-Hub - 6" Nikl-Brnz Ring & Strainer	B	1	1	\$820.00
<b>7" SQUARE STRAINER</b>					
862-227NQ	2" No-Hub - 7" Nikl-Brnz Ring & Strainer	B	1	1	\$1,000.00
862-237NQ	3" No-Hub - 7" Nikl-Brnz Ring & Strainer	B	1	1	\$1,000.00
862-247NQ	4" No-Hub - 7" Nikl-Brnz Ring & Strainer	B	1	1	\$1,000.00
<b>8" SQUARE STRAINER</b>					
862-228NQ	2" No-Hub - 8" Nikl-Brnz Ring & Strainer	B	1	1	\$1,300.00
862-238NQ	3" No-Hub - 8" Nikl-Brnz Ring & Strainer	B	1	1	\$1,300.00
862-248NQ	4" No-Hub - 8" Nikl-Brnz Ring & Strainer	B	1	1	\$1,300.00
<b>10" SQUARE STRAINER</b>					
862-2210NQ	2" No-Hub - 10" Nikl-Brnz Ring & Strainer	B	1	1	\$1,600.00
862-2310NQ	3" No-Hub - 10" Nikl-Brnz Ring & Strainer	B	1	1	\$1,600.00
862-2410NQ	4" No-Hub - 10" Nikl-Brnz Ring & Strainer	B	1	1	\$1,600.00

Supply

Drainage

Support

Specialties

Appendix

## Cast Iron - No-Hub Connection (Cont)

### Nickel-Bronze Ring & Strainer

Item Number	Item Description	Pkg Type	Min Qty	Case Qty	Price
<b>ACCESSORIES</b>					
862-EX4	4" Threaded Extension Adapter - MIP X FIP	B	1	1	\$120.00
863-FACQ	Round Aluminum Condensate Funnel w/ Screws	BI	1	12	\$168.00
863-FNCQ	Round Nikl-Brnz Condensate Funnel w/ Screws	BI	1	12	\$370.00
863-FNOCQ	Oval Nikl-Brnz Condensate Funnel w/ Screws	BI	1	12	\$815.00



862-247NRE

## Cast Iron - No-Hub Connection

### Nickel-Bronze Ring & Strainer - Extended Rim

- Nickel-bronze head with extended strainer rim prevents floor-level waste from entering the fixture
- Cast iron drain body with clamping collar

**Options:** Add suffix to item no. Add price to list

A = Acid-Resistant Epoxy Coated Cast Iron: \$275.00; B = Sediment Bucket: \$105.00;

Item Number	Item Description	Pkg Type	Min Qty	Case Qty	Price
<b>7" ROUND STRAINER</b>					
862-227NRE	2" No-Hub - 7" Nikl-Brnz Ring & Strainer	B	1	1	\$1,400.00
862-237NRE	3" No-Hub - 7" Nikl-Brnz Ring & Strainer	B	1	1	\$1,400.00
862-247NRE	4" No-Hub - 7" Nikl-Brnz Ring & Strainer	B	1	1	\$1,400.00
<b>10" ROUND STRAINER</b>					
862-2210NRE	2" No-Hub - 10" Nikl-Brnz Ring & Strainer	B	1	1	\$1,600.00
862-2310NRE	3" No-Hub - 10" Nikl-Brnz Ring & Strainer	B	1	1	\$1,600.00
862-2410NRE	4" No-Hub - 10" Nikl-Brnz Ring & Strainer	B	1	1	\$1,600.00
<b>ACCESSORIES</b>					
862-EX4	4" Threaded Extension Adapter - MIP X FIP	B	1	1	\$120.00



862-245SR

## Cast Iron - No-Hub Connection

### Stainless Steel Ring & Strainer

**Options:** Add suffix to item no. Add price to list

A = Acid-Resistant Epoxy Coated Cast Iron: \$275.00; B = Sediment Bucket: \$105.00;

Item Number	Item Description	Pkg Type	Min Qty	Case Qty	Price
<b>5" ROUND STRAINER</b>					
862-225SR	2" No-Hub - 5" Stnls Steel Ring & Strainer	B	1	1	\$1,100.00
862-235SR	3" No-Hub - 5" Stnls Steel Ring & Strainer	B	1	1	\$1,100.00
862-245SR	4" No-Hub - 5" Stnls Steel Ring & Strainer	B	1	1	\$1,100.00



## Cast Iron - No-Hub Connection (Cont)

### Stainless Steel Ring & Strainer

Item Number	Item Description	Pkg Type	Min Qty	Case Qty	Price
<b>6" ROUND STRAINER</b>					
862-226SR	2" No-Hub - 6" Stnls Steel Ring & Strainer	B	1	1	\$1,350.00
862-236SR	3" No-Hub - 6" Stnls Steel Ring & Strainer	B	1	1	\$1,350.00
862-246SR	4" No-Hub - 6" Stnls Steel Ring & Strainer	B	1	1	\$1,350.00
<b>5" SQUARE STRAINER</b>					
862-225SQ	2" No-Hub - 5" Stnls Steel Ring & Strainer	B	1	1	\$1,200.00
862-235SQ	3" No-Hub - 5" Stnls Steel Ring & Strainer	B	1	1	\$1,200.00
862-245SQ	4" No-Hub - 5" Stnls Steel Ring & Strainer	B	1	1	\$1,200.00
<b>6" SQUARE STRAINER</b>					
862-226SQ	2" No-Hub - 6" Stnls Steel Ring & Strainer	B	1	1	\$1,440.00
862-236SQ	3" No-Hub - 6" Stnls Steel Ring & Strainer	B	1	1	\$1,440.00
862-246SQ	4" No-Hub - 6" Stnls Steel Ring & Strainer	B	1	1	\$1,440.00
<b>ACCESSORIES</b>					
862-EX4	4" Threaded Extension Adapter - MIP X FIP	B	1	1	\$120.00



862-245SQ

## Cast Iron - No-Hub Connection

### Cast Iron Strainer

**Options:** Add suffix to item no. Add price to list

A = Acid-Resistant Epoxy Coated Cast Iron: \$275.00; B = Sediment Bucket: \$105.00;

Item Number	Item Description	Pkg Type	Min Qty	Case Qty	Price
<b>7" ROUND STRAINER</b>					
862-227I	2" No-Hub - 7" Ductile Iron Ring & Strainer	B	1	1	\$700.00
862-227IN	2" No-Hub - 7-1/4" Ductile Iron w/ NB Veneer Ring & Strainer	B	1	1	\$900.00
862-237I	3" No-Hub - 7" Ductile Iron Ring & Strainer	B	1	1	\$700.00
862-237IN	3" No-Hub - 7-1/4" Ductile Iron w/ NB Veneer Ring & Strainer	B	1	1	\$900.00
862-247I	4" No-Hub - 7" Ductile Iron Ring & Strainer	B	1	1	\$700.00
862-247IN	4" No-Hub - 7-1/4" Ductile Iron w/ NB Veneer Ring & Strainer	B	1	1	\$900.00
<b>9" ROUND STRAINER</b>					
862-229I	2" No-Hub - 9" Ductile Iron Ring & Strainer	B	1	1	\$900.00
862-229IN	2" No-Hub - 9-3/8" Ductile Iron w/ NB Veneer Ring & Strainer	B	1	1	\$1,250.00
862-239I	3" No-Hub - 9" Ductile Iron Ring & Strainer	B	1	1	\$900.00
862-239IN	3" No-Hub - 9-3/8" Ductile Iron w/ NB Veneer Ring & Strainer	B	1	1	\$1,250.00
862-249I	4" No-Hub - 9" Ductile Iron Ring & Strainer	B	1	1	\$900.00
862-249IN	4" No-Hub - 9-3/8" Ductile Iron w/ NB Veneer Ring & Strainer	B	1	1	\$1,250.00
<b>ACCESSORIES</b>					
862-EX4	4" Threaded Extension Adapter - MIP X FIP	B	1	1	\$120.00



862-237I



862-237IN



862-239I

**Cast Iron - Push-Joint Connection**

**Nickel-Bronze Ring & Strainer**

Options: Add suffix to item no. Add price to list

A = Acid-Resistant Epoxy Coated Cast Iron: \$275.00; B = Sediment Bucket: \$105.00;



862-625NR



862-625NQ

Item Number	Item Description	Pkg Type	Min Qty	Case Qty	Price
<b>5" ROUND STRAINER</b>					
862-625NR	2" PJ Conn. - 5" Nikl-Brnz Ring & Strainer	B	1	1	\$600.00
862-635NR	3" PJ Conn. - 5" Nikl-Brnz Ring & Strainer	B	1	1	\$600.00
862-645NR	4" PJ Conn. - 5" Nikl-Brnz Ring & Strainer	B	1	1	\$600.00
<b>6" ROUND STRAINER</b>					
862-626NR	2" PJ Conn. - 6" Nikl-Brnz Ring & Strainer	B	1	1	\$700.00
862-636NR	3" PJ Conn. - 6" Nikl-Brnz Ring & Strainer	B	1	1	\$700.00
862-646NR	4" PJ Conn. - 6" Nikl-Brnz Ring & Strainer	B	1	1	\$700.00
<b>7" ROUND STRAINER</b>					
862-627NR	2" PJ Conn. - 7" Nikl-Brnz Ring & Strainer	B	1	1	\$900.00
862-637NR	3" PJ Conn. - 7" Nikl-Brnz Ring & Strainer	B	1	1	\$900.00
862-647NR	4" PJ Conn. - 7" Nikl-Brnz Ring & Strainer	B	1	1	\$845.00
<b>8" ROUND STRAINER</b>					
862-628NR	2" PJ Conn. - 8" Nikl-Brnz Ring & Strainer	B	1	1	\$1,000.00
862-638NR	3" PJ Conn. - 8" Nikl-Brnz Ring & Strainer	B	1	1	\$1,000.00
862-648NR	4" PJ Conn. - 8" Nikl-Brnz Ring & Strainer	B	1	1	\$1,000.00
<b>10" ROUND STRAINER</b>					
862-6210NR	2" PJ Conn. - 10" Nikl-Brnz Ring & Strainer	B	1	1	\$1,300.00
862-6310NR	3" PJ Conn. - 10" Nikl-Brnz Ring & Strainer	B	1	1	\$1,300.00
862-6410NR	4" PJ Conn. - 10" Nikl-Brnz Ring & Strainer	B	1	1	\$1,300.00
<b>5" SQUARE STRAINER</b>					
862-625NQ	2" PJ Conn. - 5" Nikl-Brnz Ring & Strainer	B	1	1	\$720.00
862-635NQ	3" PJ Conn. - 5" Nikl-Brnz Ring & Strainer	B	1	1	\$720.00
862-645NQ	4" PJ Conn. - 5" Nikl-Brnz Ring & Strainer	B	1	1	\$720.00
<b>6" SQUARE STRAINER</b>					
862-626NQ	2" PJ Conn. - 6" Nikl-Brnz Ring & Strainer	B	1	1	\$820.00
862-636NQ	3" PJ Conn. - 6" Nikl-Brnz Ring & Strainer	B	1	1	\$820.00
862-646NQ	4" PJ Conn. - 6" Nikl-Brnz Ring & Strainer	B	1	1	\$820.00
<b>7" SQUARE STRAINER</b>					
862-627NQ	2" PJ Conn. - 7" Nikl-Brnz Ring & Strainer	B	1	1	\$1,000.00
862-637NQ	3" PJ Conn. - 7" Nikl-Brnz Ring & Strainer	B	1	1	\$1,000.00
862-647NQ	4" PJ Conn. - 7" Nikl-Brnz Ring & Strainer	B	1	1	\$1,000.00
<b>8" SQUARE STRAINER</b>					
862-628NQ	2" PJ Conn. - 8" Nikl-Brnz Ring & Strainer	B	1	1	\$1,300.00
862-638NQ	3" PJ Conn. - 8" Nikl-Brnz Ring & Strainer	B	1	1	\$1,300.00
862-648NQ	4" PJ Conn. - 8" Nikl-Brnz Ring & Strainer	B	1	1	\$1,300.00
<b>10" SQUARE STRAINER</b>					
862-6210NQ	2" PJ Conn. - 10" Nikl-Brnz Ring & Strainer	B	1	1	\$1,600.00
862-6310NQ	3" PJ Conn. - 10" Nikl-Brnz Ring & Strainer	B	1	1	\$1,600.00
862-6410NQ	4" PJ Conn. - 10" Nikl-Brnz Ring & Strainer	B	1	1	\$1,600.00
<b>ACCESSORIES</b>					
862-EX4	4" Threaded Extension Adapter - MIP X FIP	B	1	1	\$120.00
863-FACQ	Round Aluminum Condensate Funnel w/ Screws	BI	1	12	\$168.00
863-FNCQ	Round Nikl-Brnz Condensate Funnel w/ Screws	BI	1	12	\$370.00
863-FNOCQ	Oval Nikl-Brnz Condensate Funnel w/ Screws	BI	1	12	\$815.00

Supply

Drainage

Support

Specialties

Appendix

## Cast Iron - Push-Joint Connection

### Nickel-Bronze Ring & Strainer - Extended Rim

- Nickel-bronze head with extended strainer rim prevents floor-level waste from entering the fixture
- Cast iron drain body with clamping collar

**Options:** Add suffix to item no. Add price to list

A = Acid-Resistant Epoxy Coated Cast Iron: \$275.00; B = Sediment Bucket: \$105.00;



862-627NRE

Item Number	Item Description	Pkg Type	Min Qty	Case Qty	Price
<b>7" ROUND STRAINER</b>					
862-627NRE	2" PJ Conn. - 7" Nikl-Brnz Ring & Strainer	B	1	1	\$1,400.00
862-637NRE	3" PJ Conn. - 7" Nikl-Brnz Ring & Strainer	B	1	1	\$1,400.00
862-647NRE	4" PJ Conn. - 7" Nikl-Brnz Ring & Strainer	B	1	1	\$1,400.00
<b>10" ROUND STRAINER</b>					
862-6210NRE	2" PJ Conn. - 10" Nikl-Brnz Ring & Strainer	B	1	1	\$1,600.00
862-6310NRE	3" PJ Conn. - 10" Nikl-Brnz Ring & Strainer	B	1	1	\$1,600.00
862-6410NRE	4" PJ Conn. - 10" Nikl-Brnz Ring & Strainer	B	1	1	\$1,600.00
<b>ACCESSORIES</b>					
862-EX4	4" Threaded Extension Adapter - MIP X FIP	B	1	1	\$120.00

## Cast Iron - Push-Joint Connection

### Stainless Steel Ring & Strainer

**Options:** Add suffix to item no. Add price to list

A = Acid-Resistant Epoxy Coated Cast Iron: \$275.00; B = Sediment Bucket: \$105.00;



862-625SR



862-625SQ

Item Number	Item Description	Pkg Type	Min Qty	Case Qty	Price
<b>5" ROUND STRAINER</b>					
862-625SR	2" PJ Conn. - 5" Stnls Steel Ring & Strainer	B	1	1	\$1,100.00
862-635SR	3" PJ Conn. - 5" Stnls Steel Ring & Strainer	B	1	1	\$1,100.00
862-645SR	4" PJ Conn. - 5" Stnls Steel Ring & Strainer	B	1	1	\$1,100.00
<b>6" ROUND STRAINER</b>					
862-626SR	2" PJ Conn. - 6" Stnls Steel Ring & Strainer	B	1	1	\$1,350.00
862-636SR	3" PJ Conn. - 6" Stnls Steel Ring & Strainer	B	1	1	\$1,350.00
862-646SR	4" PJ Conn. - 6" Stnls Steel Ring & Strainer	B	1	1	\$1,350.00
<b>5" SQUARE STRAINER</b>					
862-625SQ	2" PJ Conn. - 5" Stnls Steel Ring & Strainer	B	1	1	\$1,200.00
862-635SQ	3" PJ Conn. - 5" Stnls Steel Ring & Strainer	B	1	1	\$1,200.00
862-645SQ	4" PJ Conn. - 5" Stnls Steel Ring & Strainer	B	1	1	\$1,200.00
<b>6" SQUARE STRAINER</b>					
862-626SQ	2" PJ Conn. - 6" Stnls Steel Ring & Strainer	B	1	1	\$1,440.00
862-636SQ	3" PJ Conn. - 6" Stnls Steel Ring & Strainer	B	1	1	\$1,440.00
862-646SQ	4" PJ Conn. - 6" Stnls Steel Ring & Strainer	B	1	1	\$1,440.00
<b>ACCESSORIES</b>					
862-EX4	4" Threaded Extension Adapter - MIP X FIP	B	1	1	\$120.00

**Cast Iron - Push-Joint Connection**

**Cast Iron Strainer**

**Options:** Add suffix to item no. Add price to list  
**A** = Acid-Resistant Epoxy Coated Cast Iron: \$275.00; **B** = Sediment Bucket: \$105.00;



862-627I



862-627IN



862-629I

Item Number	Item Description	Pkg Type	Min Qty	Case Qty	Price
<b>7" ROUND STRAINER</b>					
862-627I	2" PJ Conn. - 7" Ductile Iron Ring & Strainer	B	1	1	\$700.00
862-627IN	2" PJ Conn. - 7-1/4" Ductile Iron w/ NB Veneer Ring & Strainer	B	1	1	\$900.00
862-637I	3" PJ Conn. - 7" Ductile Iron Ring & Strainer	B	1	1	\$700.00
862-637IN	3" PJ Conn. - 7-1/4" Ductile Iron w/ NB Veneer Ring & Strainer	B	1	1	\$900.00
862-647I	4" PJ Conn. - 7" Ductile Iron Ring & Strainer	B	1	1	\$700.00
862-647IN	4" PJ Conn. - 7-1/4" Ductile Iron w/ NB Veneer Ring & Strainer	B	1	1	\$900.00
<b>9" ROUND STRAINER</b>					
862-629I	2" PJ Conn. - 9" Ductile Iron Ring & Strainer	B	1	1	\$900.00
862-629IN	2" PJ Conn. - 9-3/8" Ductile Iron w/ NB Veneer Ring & Strainer	B	1	1	\$1,250.00
862-639I	3" PJ Conn. - 9" Ductile Iron Ring & Strainer	B	1	1	\$900.00
862-639IN	3" PJ Conn. - 9-3/8" Ductile Iron w/ NB Veneer Ring & Strainer	B	1	1	\$1,250.00
862-649I	4" PJ Conn. - 9" Ductile Iron Ring & Strainer	B	1	1	\$900.00
862-649IN	4" PJ Conn. - 9-3/8" Ductile Iron w/ NB Veneer Ring & Strainer	B	1	1	\$1,250.00
<b>ACCESSORIES</b>					
862-EX4	4" Threaded Extension Adapter - MIP X FIP	B	1	1	\$120.00

Supply

Drainage

Support

Specialties

Appendix

## Halo™ Floor Drains

### Cast Iron - No-Hub Connection

**Options:** Add suffix to item no. Add price to list

**M** = Clamping collar kit (1): \$70.00; **V** = Vandal-Resistant Strainer: \$23.00;

**B** = Complies with Buy American Act (2): \$211.00; **E** = Extended Ring (2): \$267.00;

**9** = 90-deg. Side Outlet Connection: \$86.00;

1: Add 'M' code after dash - other options to end of item no. 2: For round nickel bronze ring/strainer only

Item Number	Item Description	Pkg Type	Min Qty	Case Qty	Price
<b>NICKEL-BRONZE RING &amp; STRAINER</b>					
822-2DNQ	2" No-Hub - 5-7/8" Sqr Ring & Strainer	BI	1	4	\$620.00
822-2DNR	2" No-Hub - 5-1/2" Rnd Ring & Strainer	BI	1	4	\$525.00
822-3DNQ	3" No-Hub - 5-7/8" Sqr Ring & Strainer	BI	1	4	\$620.00
822-3DNR	3" No-Hub - 5-1/2" Rnd Ring & Strainer	BI	1	4	\$525.00
<b>STAINLESS STEEL RING &amp; STRAINER</b>					
822-2DSQ	2" No-Hub - 5-7/8" Sqr Ring & Strainer	BI	1	4	\$620.00
822-2DSR	2" No-Hub - 5-1/2" Rnd Ring & Strainer	BI	1	4	\$525.00
822-3DSQ	3" No-Hub - 5-7/8" Sqr Ring & Strainer	BI	1	1	\$620.00
822-3DSR	3" No-Hub - 5-1/2" Rnd Ring & Strainer	BI	1	1	\$525.00
<b>ACCESSORIES</b>					
822-EX3CQ	Ductile Iron Extension Adapter	BI	1	1	\$125.00
835-2CQ	Trapshield™ For 2" Drain Outlet	BI	1	50	\$199.00
835-35CQ	Trapshield™ For 3-1/2" Drain Outlet	BI	1	25	\$224.00
835-3CQ	Trapshield™ For 3" Drain Outlet	BI	1	25	\$224.00
863-FACQ	Round Aluminum Condensate Funnel w/ Screws	BI	1	12	\$168.00
863-FNCQ	Round Nikl-Brnz Condensate Funnel w/ Screws	BI	1	12	\$370.00



822-2DNR



822-2DSQ

## FinishLine Halo™ Floor Drains

### Cast Iron - No-Hub Connection

**Options:** Add suffix to item no. Add price to list

**M** = Clamping collar kit (1): \$70.00; **V** = Vandal-Resistant Strainer: \$23.00;

**B** = Complies with Buy American Act (2): \$211.00; **E** = Extended Ring (2): \$267.00;

**9** = 90-deg. Side Outlet Connection: \$86.00;

1: Add 'M' code after dash - other options to end of item no. 2: For round nickel bronze ring/strainer only

Item Number	Item Description	Pkg Type	Min Qty	Case Qty	Price
<b>ROUGH-IN FIXTURE</b>					
822-2DF	2" No-Hub	BI	1	1	\$330.00
822-3DF	3" No-Hub	BI	1	4	\$330.00
<b>FINISH FIXTURE</b>					
832-3DHNQ	5-7/8" Sqr Nikl-Brnz Ring & Strainer	BI	1	1	\$360.00
832-3DHNR	5-1/2" Rnd Nikl-Brnz Ring & Strainer	BI	1	10	\$270.00
832-3DHSQ	5-7/8" Sqr Stnls Steel Ring & Strainer	BI	1	1	\$360.00
832-3DHSR	5-1/2" Rnd Stnls Steel Ring & Strainer	BI	1	1	\$270.00



822-2DF



832-3DHNQ

Supply

Drainage

Support

Specialties

Appendix



822-F3DSR

## FinishLine Halo™ Floor Drains (Cont)

### Cast Iron - No-Hub Connection

Item Number	Item Description	Pkg Type	Min Qty	Case Qty	Price
<b>COMPLETE ASSEMBLY</b>					
822-F2DNQ	2" No-Hub - 5-7/8" Sqr Nikl-Brnz Ring & Strainer	BI	1	1	\$690.00
822-F2DNR	2" No-Hub - 5-1/2" Rnd Nikl-Brnz Ring & Strainer	BI	1	1	\$600.00
822-F2DSQ	2" No-Hub - 5-7/8" Sqr Stnls Steel Ring & Strainer	BI	1	1	\$690.00
822-F2DSR	2" No-Hub - 5-1/2" Rnd Stnls Steel Ring & Strainer	BI	1	1	\$600.00
822-F3DNQ	3" No-Hub - 5-7/8" Sqr Nikl-Brnz Ring & Strainer	BI	1	1	\$690.00
822-F3DNR	3" No-Hub - 5-1/2" Rnd Nikl-Brnz Ring & Strainer	BI	1	1	\$600.00
822-F3DSQ	3" No-Hub - 5-7/8" Sqr Stnls Steel Ring & Strainer	BI	1	1	\$690.00
822-F3DSR	3" No-Hub - 5-1/2" Rnd Stnls Steel Ring & Strainer	BI	1	1	\$600.00
<b>ACCESSORIES</b>					
822-EX3CQ	Ductile Iron Extension Adapter	BI	1	1	\$125.00
832-EX3CQ	Ductile Iron Extension Adapter - 2" Min - 3-3/8" Max	BI	1	1	\$120.00
832-S3CQ	Two Adjustment Shims, Two 3/4" Screws	BI	1	1	\$22.00
835-2CQ	Trapshield™ For 2" Drain Outlet	BI	1	50	\$199.00
835-3CQ	Trapshield™ For 3" Drain Outlet	BI	1	25	\$224.00
863-FACQ	Round Aluminum Condensate Funnel w/ Screws	BI	1	12	\$168.00
863-FNCQ	Round Nikl-Brnz Condensate Funnel w/ Screws	BI	1	12	\$370.00

9" Diameter

Cast Iron - No-Hub Connection

Options: Add suffix to item no. Add price to list

S = ABS Sand Bucket: \$83.00; U = ABS Debris Bucket: \$83.00;

C = Cast Iron Clamping Collar: \$149.00; V = Vandal-Resistant Strainer (1): \$68.00;

W = Stainless Steel Debris Basket: \$180.00; F = Round Nickel-Bronze Condensate Funnel: \$370.00;

FA = Round Aluminum Condensate Funnel: \$168.00; FO = Oval Nickel-Bronze Condensate Funnel: \$815.00;

6 = ABS Flat Strainer for Drain Outlet (2): \$68.00;

1: Not available for drains with cast iron strainers 2: Not available for 6" drains

Item Number	Item Description	Pkg Type	Min Qty	Case Qty	Price
<b>NICKEL-BRONZE RING &amp; STRAINER</b>					
860-22N	2" No-Hub - 10" Rnd Grate	Bl	1	1	\$1,420.00
860-23N	3" No-Hub - 10" Rnd Grate	Bl	1	1	\$1,420.00
860-24N	4" No-Hub - 10" Rnd Grate	Bl	1	1	\$1,420.00
860-26N	6" No-Hub - 10" Rnd Grate	Bl	1	1	\$1,420.00
<b>STAINLESS STEEL RING &amp; STRAINER</b>					
860-22Z	2" No-Hub - 10" Rnd Grate	Bl	1	1	\$1,420.00
860-23Z	3" No-Hub - 10" Rnd Grate	Bl	1	1	\$1,420.00
860-24Z	4" No-Hub - 10" Rnd Grate	Bl	1	1	\$1,420.00
860-26Z	6" No-Hub - 10" Rnd Grate	Bl	1	1	\$1,420.00
<b>CAST IRON STRAINER</b>					
860-22I	2" No-Hub - 9-1/4" Rnd Grate	Bl	1	1	\$636.00
860-23I	3" No-Hub - 9-1/4" Rnd Grate	Bl	1	1	\$636.00
860-24I	4" No-Hub - 9-1/4" Rnd Grate	Bl	1	1	\$636.00
860-26I	6" No-Hub - 9-1/4" Rnd Grate	Bl	1	1	\$636.00

9" Diameter

Cast Iron - Push-Joint Connection

Options: Add suffix to item no. Add price to list

S = ABS Sand Bucket: \$83.00; U = ABS Debris Bucket: \$83.00;

C = Cast iron Clamping Collar: \$149.00; V = Vandal-Resistant Strainer (1): \$68.00;

W = Stainless Steel Debris Basket: \$180.00; F = Round Nickel-Bronze Condensate Funnel: \$370.00;

FA = Round Aluminum Condensate Funnel: \$168.00; FO = Oval Nickel-Bronze Condensate Funnel: \$815.00;

6 = ABS Flat Strainer for Drain Outlet: \$68.00; P = Push-Joint Gasket to fit Sch. 40 Pipe (2): \$25.00;

1: Not available for drains with cast iron strainers 2: For drains with 3" and 4" push-joint connections

Item Number	Item Description	Pkg Type	Min Qty	Case Qty	Price
<b>NICKEL-BRONZE RING &amp; STRAINER</b>					
860-62N	2" PJ Conn. - 10" Rnd Grate	Bl	1	1	\$1,420.00
860-63N	3" PJ Conn. - 10" Rnd Grate	Bl	1	1	\$1,420.00
860-64N	4" PJ Conn. - 10" Rnd Grate	Bl	1	1	\$1,420.00



860-22N



860-23Z



860-22I



860-62N

Supply

Drainage

Support

Specialties

Appendix

Supply

Drainage

Support

Specialties

Appendix



860-63Z



860-62I



860-R222I



860-Q222I

## 9" Diameter (Cont)

### Cast Iron - Push-Joint Connection

Item Number	Item Description	Pkg Type	Min Qty	Case Qty	Price
<b>STAINLESS STEEL RING &amp; STRAINER</b>					
860-62Z	2" PJ Conn. - 10" Rnd Grate	BI	1	1	\$1,420.00
860-63Z	3" PJ Conn. - 10" Rnd Grate	BI	1	1	\$1,420.00
860-64Z	4" PJ Conn. - 10" Rnd Grate	BI	1	1	\$1,420.00
<b>CAST IRON STRAINER</b>					
860-62I	2" PJ Conn. - 9-1/4" Rnd Grate	BI	1	1	\$636.00
860-63I	3" PJ Conn. - 9-1/4" Rnd Grate	BI	1	1	\$636.00
860-64I	4" PJ Conn. - 9-1/4" Rnd Grate	BI	1	1	\$636.00

## 12" Diameter

### Cast Iron - No-Hub Connection

Options: Add suffix to item no. Add price to list

9 = 90-deg. Side Outlet Connection (1): \$490.00; A = Acid-Resistant Epoxy Coated Cast Iron: \$1,100.00;

B = Sediment Bucket (2): \$220.00; C = Underdeck Clamp: \$230.00;

E = Adjustable Extension: \$690.00; H = Hinged Square Grate: \$650.00;

X = Extra Heavy-duty Grate: \$250.00;

1: For 2" - 4" No-Hub Only 2: Not available for drains with Adjustable Extension

Item Number	Item Description	Pkg Type	Min Qty	Case Qty	Price
<b>ROUND CAST IRON STRAINER</b>					
860-R222I	2" No-Hub - 12" Ring & Strainer	B	1	1	\$1,600.00
860-R223I	3" No-Hub - 12" Ring & Strainer	B	1	1	\$1,600.00
860-R224I	4" No-Hub - 12" Ring & Strainer	B	1	1	\$1,600.00
860-R226I	6" No-Hub - 12" Ring & Strainer	B	1	1	\$1,600.00
860-R228I	8" No-Hub - 12" Ring & Strainer	B	1	1	\$1,600.00
<b>ROUND CAST IRON STRAINER - NICKEL-BRONZE VENEER</b>					
860-R222IN	2" No-Hub - 12" Ring & Strainer	B	1	1	\$2,200.00
860-R223IN	3" No-Hub - 12" Ring & Strainer	B	1	1	\$2,200.00
860-R224IN	4" No-Hub - 12" Ring & Strainer	B	1	1	\$2,200.00
860-R226IN	6" No-Hub - 12" Ring & Strainer	B	1	1	\$2,200.00
860-R228IN	8" No-Hub - 12" Ring & Strainer	B	1	1	\$2,200.00
<b>SQUARE CAST IRON STRAINER</b>					
860-Q222I	2" No-Hub - 12" Ring & Strainer	B	1	1	\$1,860.00
860-Q223I	3" No-Hub - 12" Ring & Strainer	B	1	1	\$1,860.00
860-Q224I	4" No-Hub - 12" Ring & Strainer	B	1	1	\$1,860.00
860-Q226I	6" No-Hub - 12" Ring & Strainer	B	1	1	\$1,860.00
860-Q228I	8" No-Hub - 12" Ring & Strainer	B	1	1	\$1,860.00
<b>SQUARE CAST IRON STRAINER - NICKEL-BRONZE VENEER</b>					
860-Q222IN	2" No-Hub - 12" Ring & Strainer	B	1	1	\$2,800.00
860-Q223IN	3" No-Hub - 12" Ring & Strainer	B	1	1	\$2,800.00
860-Q224IN	4" No-Hub - 12" Ring & Strainer	B	1	1	\$2,800.00
860-Q226IN	6" No-Hub - 12" Ring & Strainer	B	1	1	\$2,800.00
860-Q228IN	8" No-Hub - 12" Ring & Strainer	B	1	1	\$2,800.00



**12" Diameter**

**Cast Iron - Push-Joint Connection**

**Options:** Add suffix to item no. Add price to list

**9** = 90-deg. Side Outlet Connection (1): \$490.00; **A** = Acid-Resistant Epoxy Coated Cast Iron: \$1,100.00;

**B** = Sediment Bucket (2): \$220.00; **C** = Underdeck Clamp: \$230.00;

**E** = Adjustable Extension: \$690.00; **H** = Hinged Square Grate: \$650.00;

**X** = Extra Heavy-duty Grate: \$250.00;

1: For 2" - 4" No-Hub Only 2: Not available for drains with Adjustable Extension



860-R262I



860-Q262I

Item Number	Item Description	Pkg Type	Min Qty	Case Qty	Price
<b>ROUND CAST IRON STRAINER</b>					
860-R262I	2" PJ Conn. - 12" Ring & Strainer	B	1	1	\$1,575.00
860-R263I	3" PJ Conn. - 12" Ring & Strainer	B	1	1	\$1,600.00
860-R264I	4" PJ Conn. - 12" Ring & Strainer	B	1	1	\$1,600.00
860-R266I	6" PJ Conn. - 12" Ring & Strainer	B	1	1	\$1,600.00
<b>ROUND CAST IRON STRAINER - NICKEL-BRONZE VENEER</b>					
860-R262IN	2" PJ Conn. - 12" Ring & Strainer	B	1	1	\$2,200.00
860-R263IN	3" PJ Conn. - 12" Ring & Strainer	B	1	1	\$2,200.00
860-R264IN	4" PJ Conn. - 12" Ring & Strainer	B	1	1	\$2,200.00
860-R266IN	6" PJ Conn. - 12" Ring & Strainer	B	1	1	\$2,200.00
<b>SQUARE CAST IRON STRAINER</b>					
860-Q262I	2" PJ Conn. - 12" Ring & Strainer	B	1	1	\$1,860.00
860-Q263I	3" PJ Conn. - 12" Ring & Strainer	B	1	1	\$1,860.00
860-Q264I	4" PJ Conn. - 12" Ring & Strainer	B	1	1	\$1,860.00
860-Q266I	6" PJ Conn. - 12" Ring & Strainer	B	1	1	\$1,860.00
<b>SQUARE CAST IRON STRAINER - NICKEL-BRONZE VENEER</b>					
860-Q262IN	2" PJ Conn. - 12" Ring & Strainer	B	1	1	\$2,800.00
860-Q263IN	3" PJ Conn. - 12" Ring & Strainer	B	1	1	\$2,800.00
860-Q264IN	4" PJ Conn. - 12" Ring & Strainer	B	1	1	\$2,800.00
860-Q266IN	6" PJ Conn. - 12" Ring & Strainer	B	1	1	\$2,800.00

**Stainless Steel**

**No-Hub Connection**

Item Number	Item Description	Pkg Type	Min Qty	Case Qty	Price
<b>DRAINS</b>					
860-3SS	3" No-Hub - 6-3/4" Rnd Grate	BI	1	1	\$3,660.00
860-4SS	4" No-Hub - 8-7/8" Rnd Grate	BI	1	1	\$4,280.00
<b>ACCESSORIES</b>					
860-3SSS	6-3/4" Rnd Grate	B	1	1	\$929.00
860-4SSS	8-7/8" Rnd Grate	BI	1	1	\$1,299.00
860-4SSU	Debris Bucket For 860-4SS	BI	1	1	\$287.00



860-3SS



860-3SSS

Supply

Drainage

Support

Specialties

Appendix

Supply

Drainage

Support

Specialties

Appendix



862-45LNR

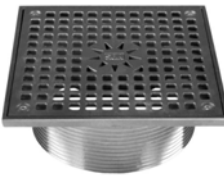

862-45LNQ

## Adjustable Floor Drain Head

### Nickel-Bronze - MIP Thread Connection

- Nickel-bronze head/strainer with 4" MIP threads

**Options:** Add suffix to item no. Add price to list

**B** = Sediment Bucket: \$105.00;

Item Number	Item Description	Pkg Type	Min Qty	Case Qty	Price
<b>ROUND STRAINER</b>					
862-410LNR	4" MIP - 10" Nikl-Brnz Ring & Strainer	BI	1	8	\$1,030.00
862-45LNR	4" MIP - 5" Nikl-Brnz Ring & Strainer	BI	1	20	\$330.00
862-46LNR	4" MIP - 6" Nikl-Brnz Ring & Strainer	BI	1	20	\$430.00
862-47LNR	4" MIP - 7" Nikl-Brnz Ring & Strainer	BI	1	12	\$630.00
862-48LNR	4" MIP - 8" Nikl-Brnz Ring & Strainer	BI	1	8	\$730.00
<b>SQUARE STRAINER</b>					
862-410LNQ	4" MIP - 10" Nikl-Brnz Ring & Strainer	BI	1	4	\$1,330.00
862-45LNQ	4" MIP - 5" Nikl-Brnz Ring & Strainer	BI	1	20	\$450.00
862-46LNQ	4" MIP - 6" Nikl-Brnz Ring & Strainer	BI	1	16	\$550.00
862-47LNQ	4" MIP - 7" Nikl-Brnz Ring & Strainer	BI	1	12	\$730.00
862-48LNQ	4" MIP - 8" Nikl-Brnz Ring & Strainer	BI	1	8	\$1,030.00
<b>ACCESSORIES</b>					
862-EX4	4" Threaded Extension Adapter - MIP X FIP	B	1	1	\$120.00

## Adjustable Floor Drain Head

### Nickel-Bronze Extended Rim - MIP Thread Connection

- Nickel-bronze head/strainer with 4" MIP threads
- Extended strainer rim prevents floor-level waste from entering the fixture

**Options:** Add suffix to item no. Add price to list

**B** = Sediment Bucket: \$105.00;



862-47LNRE

Item Number	Item Description	Pkg Type	Min Qty	Case Qty	Price
<b>ROUND EXTENDED RIM</b>					
862-410LNRE	4" MIP - 10" Nikl-Brnz Ring & Strainer w/ Extended Rim	BI	1	8	\$1,330.00
862-47LNRE	4" MIP - 7" Nikl-Brnz Ring & Strainer w/ Extended Rim	BI	1	8	\$1,130.00
<b>ACCESSORIES</b>					
862-EX4	4" Threaded Extension Adapter - MIP X FIP	B	1	1	\$120.00

## Adjustable Floor Drain Head

### Stainless Steel - MIP Thread Connection

· Stainless steel head/strainer with 4" MIP threads

**Options:** Add suffix to item no. Add price to list

**B** = Sediment Bucket: \$105.00;

Item Number	Item Description	Pkg Type	Min Qty	Case Qty	Price
<b>ROUND STRAINER</b>					
862-45LSR	4" MIP - 5" Stnls Steel Ring & Strainer	BI	1	24	\$830.00
862-46LSR	4" MIP - 6" Stnls Steel Ring & Strainer	BI	1	20	\$1,080.00
<b>SQUARE STRAINER</b>					
862-45LSQ	4" MIP - 5" Stnls Steel Ring & Strainer	BI	1	20	\$900.00
862-46LSQ	4" MIP - 6" Stnls Steel Ring & Strainer	BI	1	16	\$1,170.00
<b>ACCESSORIES</b>					
862-EX4	4" Threaded Extension Adapter - MIP X FIP	B	1	1	\$120.00



862-45LSR



862-45LSQ

## Adjustable Floor Drain Head

### Cast Iron - MIP Thread Connection

· Cast iron head/strainer with 4" MIP threads

**Options:** Add suffix to item no. Add price to list

**B** = Sediment Bucket: \$105.00;

Item Number	Item Description	Pkg Type	Min Qty	Case Qty	Price
<b>ROUND CAST IRON RING &amp; STRAINER</b>					
862-47LI	4" MIP - 7" Ductile Iron Ring & Strainer	BI	1	1	\$430.00
862-49LI	4" MIP - 9" Ductile Iron Ring & Strainer	BI	1	1	\$630.00
<b>ROUND CAST IRON RING &amp; STRAINER - NICKEL-BRONZE VENEER</b>					
862-47LIN	4" MIP - 7" Ductile Iron Ring & Strainer w/ NB Veneer	BI	1	4	\$630.00
862-49LIN	4" MIP - 9" Ductile Iron Ring & Strainer w/ NB Veneer	BI	1	1	\$980.00
<b>ACCESSORIES</b>					
862-EX4	4" Threaded Extension Adapter - MIP X FIP	B	1	1	\$120.00



862-47LI



862-47LIN

Supply

Drainage

Support

Specialties

Appendix



835-3CQ

### TrapShield™

#### Trap Protection Device

Item Number	Item Description	Pkg Type	Min Qty	Case Qty	Price
835-2CQ	Trapshield™ For 2" Drain Outlet	BI	1	50	\$199.00
835-35CQ	Trapshield™ For 3-1/2" Drain Outlet	BI	1	25	\$224.00
835-3CQ	Trapshield™ For 3" Drain Outlet	BI	1	25	\$224.00
835-4CQ	Trapshield™ For 4" Drain Outlet	BI	1	20	\$265.00

### DeckAnchor™ Fixture Mounting Fitting

#### Cast Iron - No-Hub Connection



836-2

Item Number	Item Description	Pkg Type	Min Qty	Case Qty	Price
836-2	DeckAnchor™ 2" No-Hub	BI	1	1	\$394.00
836-3	DeckAnchor™ 3" No-Hub	BI	1	1	\$424.00
836-4	DeckAnchor™ 4" No-Hub	BI	1	1	\$453.00
836-6	DeckAnchor™ 6" No-Hub	BI	1	1	\$485.00

### Floor Drain Adapters

#### Flashing Drain Adapters - 4" FIP Thread



862-B23

- Cast iron body and clamping collar with 4" FIP thread
- For use with 862 Series adjustable floor drain heads

Item Number	Item Description	Pkg Type	Min Qty	Case Qty	Price
<b>CAST IRON - NO-HUB CONNECTION</b>					
862-B22	4" FIP x 2" No-Hub	B	1	1	\$270.00
862-B23	4" FIP x 3" No-Hub	B	1	1	\$270.00
862-B24	4" FIP x 4" No-Hub	B	1	1	\$270.00
<b>CAST IRON - PUSH-JOINT CONNECTION</b>					
862-B62	4" FIP x 2" PJ Conn.	B	1	1	\$270.00
862-B63	4" FIP x 3" PJ Conn.	B	1	1	\$270.00
862-B64	4" FIP x 4" PJ Conn.	B	1	1	\$270.00



862-B63

### Floor Drain Adapters

#### No-Hub Adapters



842-221

Item Number	Item Description	Pkg Type	Min Qty	Case Qty	Price
<b>CAST IRON - FIP X NO-HUB ADAPTER</b>					
842-221	2" Cast Iron No-Hub w/ 2" FIP Thread	BI	1	2	\$57.00
842-241	4" Cast Iron No-Hub w/ 4" FIP Thread	BI	1	2	\$57.00

## Floor Drain Adapters

### Push-Joint Adapters

**Options:** Add suffix to item no. Add price to list  
 P = Push-joint gasket to fit Sc. 40 ABS/PVC pipe: \$7.50;

Item Number	Item Description	Pkg Type	Min Qty	Case Qty	Price
<b>CAST IRON - FIP X PUSH-JOINT ADAPTER</b>					
858-63L	3" PJ Conn. w/ 3" FIP Thread	BI	1	4	\$45.12
858-64L	4" PJ Conn. w/ 4" FIP Thread	BI	1	4	\$158.00



858-64L

## Condensate Funnels

- Mounts to floor drain strainer to catch indirect waste and prevent splash/spatter
- Nickel-bronze and aluminum material resists corrosion

Item Number	Item Description	Pkg Type	Min Qty	Case Qty	Price
<b>ROUND 4"</b>					
863-FACQ	Round Aluminum Condensate Funnel w/ Screws	BI	1	12	\$168.00
863-FNCQ	Round Nikl-Brnz Condensate Funnel w/ Screws	BI	1	12	\$370.00
<b>OVAL 4" X 9"</b>					
863-FNOCQ	Oval Nikl-Brnz Condensate Funnel w/ Screws	BI	1	12	\$815.00



863-FACQ

Supply

Drainage

Support

Specialties

Appendix



# Specification Floor Sinks

**Cast Iron Square Floor Sinks**

**Cast Iron Round Floor Sinks**

**FatMax™ Stainless Steel  
Floor Sinks**



Cast iron floor sinks are enamel coated for resistance to abrasion, acids and corrosion.



**861-Q2226**  
Page 265



**861-QF2226**  
Page 265



**861-Q2328**  
Page 266



**861-QF2328**  
Page 266



**861-Q2221**  
Page 267



**861-QF2221**  
Page 267



**861-Q2286**  
Page 268



**861-QF2286**  
Page 268



**861-R2286**  
Page 269



**861-RF2286**  
Page 269



**861-R2228**  
Page 270



**861-RF2228**  
Page 270



**860-4SS**  
Page 271



12" x 12" x 6"

Cast Iron - No-Hub Connection

Options: Add suffix to item no. Add price to list

2 = Open-Half Grate (1): N/C; 3 = Open-Quarter Grate (1): N/C;

B = Aluminum Bucket: \$348.00; C = Clamping Collar (2): \$300.00;

T = 1/2" Trap Primer Connection: \$213.00;

1: For sinks with grates only 2: For sinks with anchor flange



861-Q2226



861-QF2226



861-GNQ2T



861-TA22

Item Number	Item Description	Pkg Type	Min Qty	Case Qty	Price
<b>FLOOR SINKS WITH AL DOME BOTTOM STRAINER</b>					
861-Q2226	2" No-Hub - No Grate	B	1	1	\$1,100.00
861-Q2226A	2" No-Hub - ARE Grate	B	1	1	\$1,318.00
861-Q2226N	2" No-Hub - Nikl-Brnz Grate	B	1	1	\$2,600.00
861-Q2326	3" No-Hub - No Grate	B	1	1	\$1,100.00
861-Q2326A	3" No-Hub - ARE Grate	B	1	1	\$1,318.00
861-Q2326N	3" No-Hub - Nikl-Brnz Grate	B	1	1	\$2,600.00
861-Q2426	4" No-Hub - No Grate	B	1	1	\$1,100.00
861-Q2426A	4" No-Hub - ARE Grate	B	1	1	\$1,318.00
861-Q2426N	4" No-Hub - Nikl-Brnz Grate	B	1	1	\$2,600.00
861-QF2226	2" No-Hub - No Grate, w/ Flange	B	1	1	\$1,200.00
861-QF2226A	2" No-Hub - ARE Grate, w/ Flange	B	1	1	\$1,418.00
861-QF2226N	2" No-Hub - Nikl-Brnz Grate, w/ Flange	B	1	1	\$2,700.00
861-QF2326	3" No-Hub - No Grate, w/ Flange	B	1	1	\$1,200.00
861-QF2326A	3" No-Hub - ARE Grate, w/ Flange	B	1	1	\$1,418.00
861-QF2326N	3" No-Hub - Nikl-Brnz Grate, w/ Flange	B	1	1	\$2,700.00
861-QF2426	4" No-Hub - No Grate, w/ Flange	B	1	1	\$1,200.00
861-QF2426A	4" No-Hub - ARE Grate, w/ Flange	B	1	1	\$1,418.00
861-QF2426N	4" No-Hub - Nikl-Brnz Grate, w/ Flange	B	1	1	\$2,700.00
<b>ACCESSORIES</b>					
861-BQ2	Aluminum Bucket	B	1	1	\$348.00
861-CQ2	Clamping Collar	B	1	1	\$300.00
861-GAQ2F	A.R.E. Full Grate	B	1	6	\$218.00
861-GAQ2H	A.R.E. Open-Half Grate	B	1	6	\$218.00
861-GAQ2T	A.R.E. Open-Quarter Grate	B	1	6	\$218.00
861-GNQ2F	Nickl-Brnz Full Grate	B	1	1	\$1,500.00
861-GNQ2H	Nickl-Brnz Open-Half Grate	B	1	1	\$1,500.00
861-GNQ2T	Nickl-Brnz Open-Quarter Grate	B	1	1	\$1,500.00
863-FACQ	Round Aluminum Condensate Funnel w/ Screws	Bl	1	12	\$168.00
863-FNCQ	Round Nikl-Brnz Condensate Funnel w/ Screws	Bl	1	12	\$370.00
863-FNOCQ	Oval Nikl-Brnz Condensate Funnel w/ Screws	Bl	1	12	\$815.00
<b>TRAP PRIMER ADAPTER</b>					
861-TA22	2" No-Hub - 1/2" FIP	B	1	1	\$213.00
861-TA23	3" No-Hub - 1/2" FIP	B	1	1	\$213.00
861-TA24	4" No-Hub - 1/2" FIP	B	1	1	\$213.00

Supply

Drainage

Support

Specialties

Appendix

**12" x 12" x 8"**

**Cast Iron - No-Hub Connection**

**Options:** Add suffix to item no. Add price to list  
**2** = Open-Half Grate (1): N/C; **3** = Open-Quarter Grate (1): N/C;  
**B** = Aluminum Bucket: \$348.00; **C** = Clamping Collar (2): \$300.00;  
**T** = 1/2" Trap Primer Connection: \$213.00;

1: For sinks with grates only 2: For sinks with anchor flange

Item Number	Item Description	Pkg Type	Min Qty	Case Qty	Price
<b>FLOOR SINKS WITH AL DOME BOTTOM STRAINER</b>					
861-Q2228	2" No-Hub - No Grate	B	1	1	\$1,200.00
<b>861-Q2228A</b>	2" No-Hub - ARE Grate	B	1	1	\$1,418.00
<b>861-Q2228N</b>	2" No-Hub - Nikl-Brnz Grate	B	1	1	\$2,700.00
861-Q2328	3" No-Hub - No Grate	B	1	1	\$1,200.00
<b>861-Q2328A</b>	3" No-Hub - ARE Grate	B	1	1	\$1,418.00
<b>861-Q2328N</b>	3" No-Hub - Nikl-Brnz Grate	B	1	1	\$2,700.00
<b>861-Q2428</b>	4" No-Hub - No Grate	B	1	1	\$2,450.00
<b>861-Q2428A</b>	4" No-Hub - ARE Grate	B	1	1	\$1,200.00
<b>861-Q2428N</b>	4" No-Hub - Nikl-Brnz Grate	B	1	1	\$2,700.00
<b>861-QF2228</b>	2" No-Hub - No Grate, w/ Flange	B	1	1	\$1,300.00
<b>861-QF2228A</b>	2" No-Hub - ARE Grate, w/ Flange	B	1	1	\$1,518.00
<b>861-QF2228N</b>	2" No-Hub - Nikl-Brnz Grate, w/ Flange	B	1	1	\$2,800.00
<b>861-QF2328</b>	3" No-Hub - No Grate, w/ Flange	B	1	1	\$1,300.00
<b>861-QF2328A</b>	3" No-Hub - ARE Grate, w/ Flange	B	1	1	\$1,518.00
<b>861-QF2328N</b>	3" No-Hub - Nikl-Brnz Grate, w/ Flange	B	1	1	\$2,800.00
<b>861-QF2428</b>	4" No-Hub - No Grate, w/ Flange	B	1	1	\$1,300.00
<b>861-QF2428A</b>	4" No-Hub - ARE Grate, w/ Flange	B	1	1	\$1,518.00
<b>861-QF2428N</b>	4" No-Hub - Nikl-Brnz Grate, w/ Flange	B	1	1	\$2,800.00
<b>ACCESSORIES</b>					
<b>861-BQ2</b>	Aluminum Bucket	B	1	1	\$348.00
<b>861-CQ2</b>	Clamping Collar	B	1	1	\$300.00
861-GAQ2F	A.R.E. Full Grate	B	1	6	\$218.00
861-GAQ2H	A.R.E. Open-Half Grate	B	1	6	\$218.00
861-GAQ2T	A.R.E. Open-Quarter Grate	B	1	6	\$218.00
<b>861-GNQ2F</b>	Nickl-Brnz Full Grate	B	1	1	\$1,500.00
<b>861-GNQ2H</b>	Nickl-Brnz Open-Half Grate	B	1	1	\$1,500.00
<b>861-GNQ2T</b>	Nickl-Brnz Open-Quarter Grate	B	1	1	\$1,500.00
<b>863-FACQ</b>	Round Aluminum Condensate Funnel w/ Screws	BI	1	12	\$168.00
<b>863-FNCQ</b>	Round Nikl-Brnz Condensate Funnel w/ Screws	BI	1	12	\$370.00
<b>863-FNOCQ</b>	Oval Nikl-Brnz Condensate Funnel w/ Screws	BI	1	12	\$815.00
<b>TRAP PRIMER ADAPTER</b>					
<b>861-TA22</b>	2" No-Hub - 1/2" FIP	B	1	1	\$213.00
<b>861-TA23</b>	3" No-Hub - 1/2" FIP	B	1	1	\$213.00
<b>861-TA24</b>	4" No-Hub - 1/2" FIP	B	1	1	\$213.00



861-Q2328



861-QF2228



861-GNQ2H



861-TA23

Supply

Drainage

Support

Specialties

Appendix

12" x 12" x 10"

Cast Iron - No-Hub Connection

Options: Add suffix to item no. Add price to list

2 = Open-Half Grate (1): N/C; 3 = Open-Quarter Grate (1): N/C;  
 B = Aluminum Bucket: \$348.00; C = Clamping Collar (2): \$300.00;  
 T = 1/2" Trap Primer Connection: \$213.00;

1: For sinks with grates only 2: For sinks with anchor flange

Item Number	Item Description	Pkg Type	Min Qty	Case Qty	Price
<b>FLOOR SINKS WITH AL DOME BOTTOM STRAINER</b>					
861-Q2221	2" No-Hub - No Grate	B	1	1	\$1,300.00
861-Q2221A	2" No-Hub - ARE Grate	B	1	1	\$1,518.00
861-Q2221N	2" No-Hub - Nikl-Brnz Grate	B	1	1	\$2,800.00
861-Q2321	3" No-Hub - No Grate	B	1	1	\$1,300.00
861-Q2321A	3" No-Hub - ARE Grate	B	1	1	\$1,518.00
861-Q2321N	3" No-Hub - Nikl-Brnz Grate	B	1	1	\$2,800.00
861-Q2421	4" No-Hub - No Grate	B	1	1	\$1,300.00
861-Q2421A	4" No-Hub - ARE Grate	B	1	1	\$1,518.00
861-Q2421N	4" No-Hub - Nikl-Brnz Grate	B	1	1	\$2,800.00
861-QF2221	2" No-Hub - No Grate, w/ Flange	B	1	1	\$1,400.00
861-QF2221A	2" No-Hub - ARE Grate, w/ Flange	B	1	1	\$1,618.00
861-QF2221N	2" No-Hub - Nikl-Brnz Grate, w/ Flange	B	1	1	\$2,900.00
861-QF2321	3" No-Hub - No Grate, w/ Flange	B	1	1	\$1,400.00
861-QF2321A	3" No-Hub - ARE Grate, w/ Flange	B	1	1	\$1,618.00
861-QF2321N	3" No-Hub - Nikl-Brnz Grate, w/ Flange	B	1	1	\$2,900.00
861-QF2421	4" No-Hub - No Grate, w/ Flange	B	1	1	\$1,400.00
861-QF2421A	4" No-Hub - ARE Grate, w/ Flange	B	1	1	\$1,618.00
861-QF2421N	4" No-Hub - Nikl-Brnz Grate, w/ Flange	B	1	1	\$2,900.00
<b>ACCESSORIES</b>					
861-BQ2	Aluminum Bucket	B	1	1	\$348.00
861-CQ2	Clamping Collar	B	1	1	\$300.00
861-GAQ2F	A.R.E. Full Grate	B	1	6	\$218.00
861-GAQ2H	A.R.E. Open-Half Grate	B	1	6	\$218.00
861-GAQ2T	A.R.E. Open-Quarter Grate	B	1	6	\$218.00
861-GNQ2F	Nickl-Brnz Full Grate	B	1	1	\$1,500.00
861-GNQ2H	Nickl-Brnz Open-Half Grate	B	1	1	\$1,500.00
861-GNQ2T	Nickl-Brnz Open-Quarter Grate	B	1	1	\$1,500.00
863-FACQ	Round Aluminum Condensate Funnel w/ Screws	Bl	1	12	\$168.00
863-FNCQ	Round Nikl-Brnz Condensate Funnel w/ Screws	Bl	1	12	\$370.00
863-FNOCQ	Oval Nikl-Brnz Condensate Funnel w/ Screws	Bl	1	12	\$815.00
<b>TRAP PRIMER ADAPTER</b>					
861-TA22	2" No-Hub - 1/2" FIP	B	1	1	\$213.00
861-TA23	3" No-Hub - 1/2" FIP	B	1	1	\$213.00
861-TA24	4" No-Hub - 1/2" FIP	B	1	1	\$213.00



861-Q2221



861-QF2221

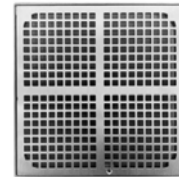

861-GNQ2F



861-TA24

Supply

Drainage

Support

Specialties

Appendix

**8" x 8" x 6"**

**Cast Iron - No-Hub Connection**

**Options:** Add suffix to item no. Add price to list  
**2** = Open-Half Grate (1): N/C; **3** = Open-Quarter Grate (1): N/C;  
**B** = Aluminum Bucket: \$250.00; **C** = Clamping Collar (2): \$202.00;  
**T** = 1/2" Trap Primer Connection: \$213.00;

1: For sinks with grates only 2: For sinks with anchor flange

Item Number	Item Description	Pkg Type	Min Qty	Case Qty	Price
<b>FLOOR SINKS WITH AL DOME BOTTOM STRAINER</b>					
861-Q2286	2" No-Hub - No Grate	B	1	1	\$1,000.00
861-Q2286A	2" No-Hub - ARE Grate	B	1	1	\$1,218.00
861-Q2286N	2" No-Hub - Nikl-Brnz Grate	B	1	1	\$1,900.00
861-Q2386	3" No-Hub - No Grate	B	1	1	\$1,000.00
861-Q2386A	3" No-Hub - ARE Grate	B	1	1	\$1,218.00
861-Q2386N	3" No-Hub - Nikl-Brnz Grate	B	1	1	\$1,900.00
861-Q2486	4" No-Hub - No Grate	B	1	1	\$1,000.00
861-Q2486A	4" No-Hub - ARE Grate	B	1	1	\$1,218.00
861-Q2486N	4" No-Hub - Nikl-Brnz Grate	B	1	1	\$1,900.00
861-QF2286	2" No-Hub - No Grate, w/ Flange	B	1	1	\$1,100.00
861-QF2286A	2" No-Hub - ARE Grate, w/ Flange	B	1	1	\$1,318.00
861-QF2286N	2" No-Hub - Nikl-Brnz Grate, w/ Flange	B	1	1	\$2,000.00
861-QF2386	3" No-Hub - No Grate, w/ Flange	B	1	1	\$1,100.00
861-QF2386A	3" No-Hub - ARE Grate, w/ Flange	B	1	1	\$1,318.00
861-QF2386N	3" No-Hub - Nikl-Brnz Grate, w/ Flange	B	1	1	\$2,000.00
861-QF2486	4" No-Hub - No Grate, w/ Flange	B	1	1	\$1,100.00
861-QF2486A	4" No-Hub - ARE Grate, w/ Flange	B	1	1	\$1,318.00
861-QF2486N	4" No-Hub - Nikl-Brnz Grate, w/ Flange	B	1	1	\$2,000.00
<b>ACCESSORIES</b>					
861-BQ8	Aluminum Bucket	B	1	1	\$250.00
861-CQ8	Clamping Collar	B	1	1	\$202.00
861-GAQ8F	A.R.E. Full Grate	B	1	6	\$218.00
861-GAQ8H	A.R.E. Open-Half Grate	B	1	6	\$218.00
861-GAQ8T	A.R.E. Open-Quarter Grate	B	1	6	\$218.00
861-GNQ8F	Nickl-Brnz Full Grate	B	1	1	\$900.00
861-GNQ8H	Nickl-Brnz Open-Half Grate	B	1	1	\$900.00
861-GNQ8T	Nickl-Brnz Open-Quarter Grate	B	1	1	\$900.00
863-FACQ	Round Aluminum Condensate Funnel w/ Screws	BI	1	12	\$168.00
863-FNCQ	Round Nikl-Brnz Condensate Funnel w/ Screws	BI	1	12	\$370.00
863-FNOCQ	Oval Nikl-Brnz Condensate Funnel w/ Screws	BI	1	12	\$815.00
<b>TRAP PRIMER ADAPTER</b>					
861-TA22	2" No-Hub - 1/2" FIP	B	1	1	\$213.00
861-TA23	3" No-Hub - 1/2" FIP	B	1	1	\$213.00
861-TA24	4" No-Hub - 1/2" FIP	B	1	1	\$213.00



861-QA286



861-QF2286



861-GAQ8H



861-TA22

Supply

Drainage

Support

Specialties

Appendix

8" x 6"

Cast Iron - No-Hub Connection

Options: Add suffix to item no. Add price to list

2 = Open-Half Grate (1): N/C; 3 = Open-Quarter Grate (1): N/C;

B = Aluminum Bucket: \$250.00; C = Clamping Collar with Anchor Flange: \$202.00;

T = 1/2" Trap Primer Connection: \$213.00;

1: For sinks with grates only

Item Number	Item Description	Pkg Type	Min Qty	Case Qty	Price
<b>FLOOR SINKS WITH AL DOME BOTTOM STRAINER</b>					
861-R2286	2" No-Hub - No Grate	B	1	1	\$1,000.00
861-R2286A	2" No-Hub - ARE Grate	B	1	1	\$1,218.00
861-R2286N	2" No-Hub - Nikl-Brnz Grate	B	1	1	\$1,800.00
861-R2386	3" No-Hub - No Grate	B	1	1	\$1,000.00
861-R2386A	3" No-Hub - ARE Grate	B	1	1	\$1,218.00
861-R2386N	3" No-Hub - Nikl-Brnz Grate	B	1	1	\$1,800.00
861-R2486	4" No-Hub - No Grate	B	1	1	\$1,000.00
861-R2486A	4" No-Hub - ARE Grate	B	1	1	\$1,218.00
861-R2486N	4" No-Hub - Nikl-Brnz Grate	B	1	1	\$1,800.00
861-RF2286	2" No-Hub - No Grate, w/ Flange	B	1	1	\$1,100.00
861-RF2286A	2" No-Hub - ARE Grate, w/ Flange	B	1	1	\$1,318.00
861-RF2286N	2" No-Hub - Nikl-Brnz Grate, w/ Flange	B	1	1	\$1,900.00
861-RF2386	3" No-Hub - No Grate, w/ Flange	B	1	1	\$1,100.00
861-RF2386A	3" No-Hub - ARE Grate, w/ Flange	B	1	1	\$1,318.00
861-RF2386N	3" No-Hub - Nikl-Brnz Grate, w/ Flange	B	1	1	\$1,900.00
861-RF2486	4" No-Hub - No Grate, w/ Flange	B	1	1	\$1,100.00
861-RF2486A	4" No-Hub - ARE Grate, w/ Flange	B	1	1	\$1,318.00
861-RF2486N	4" No-Hub - Nikl-Brnz Grate, w/ Flange	B	1	1	\$1,900.00
<b>ACCESSORIES</b>					
861-BR8	Aluminum Bucket	B	1	1	\$250.00
861-CR8	Collar Clamp	B	1	1	\$202.00
861-GAR8F	A.R.E. Full Grate	B	1	6	\$218.00
861-GAR8H	A.R.E. Open-Half Grate	B	1	6	\$218.00
861-GAR8T	A.R.E. Open-Quarter Grate	B	1	6	\$218.00
861-GNR8F	Nickl-Brnz Full Grate	B	1	1	\$800.00
861-GNR8H	Nickl-Brnz Open-Half Grate	B	1	1	\$800.00
861-GNR8T	Nickl-Brnz Open-Quarter Grate	B	1	1	\$800.00
863-FACQ	Round Aluminum Condensate Funnel w/ Screws	Bl	1	12	\$168.00
863-FNCQ	Round Nikl-Brnz Condensate Funnel w/ Screws	Bl	1	12	\$370.00
863-FNOCQ	Oval Nikl-Brnz Condensate Funnel w/ Screws	Bl	1	12	\$815.00
<b>TRAP PRIMER ADAPTER</b>					
861-TA22	2" No-Hub - 1/2" FIP	B	1	1	\$213.00
861-TA23	3" No-Hub - 1/2" FIP	B	1	1	\$213.00
861-TA24	4" No-Hub - 1/2" FIP	B	1	1	\$213.00



861-R2286



861-RF2286



861-GAR8T



861-TA23

Supply

Drainage

Support

Specialties

Appendix

12" x 8"

Cast Iron - No-Hub Connection

**Options:** Add suffix to item no. Add price to list  
**2** = Open-Half Grate (1): N/C; **3** = Open-Quarter Grate (1): N/C;  
**B** = Aluminum Bucket: \$348.00; **C** = Clamping Collar (2): \$250.00;  
**T** = 1/2" Trap Primer Connection: \$213.00;

1: For sinks with grates only 2: For sinks with anchor flange



861-R2228



861-RF2228



Nickl-Brnz open-half grate



861-TA24

Item Number	Item Description	Pkg Type	Min Qty	Case Qty	Price
<b>FLOOR SINKS WITH AL DOME BOTTOM STRAINER</b>					
861-R2228	2" No-Hub - No Grate	B	1	1	\$1,200.00
861-R2228A	2" No-Hub - ARE Grate	B	1	1	\$1,418.00
861-R2228N	2" No-Hub - Nikl-Brnz Grate	B	1	1	\$2,700.00
861-R2328	3" No-Hub - No Grate	B	1	1	\$1,200.00
861-R2328A	3" No-Hub - ARE Grate	B	1	1	\$1,418.00
861-R2328N	3" No-Hub - Nikl-Brnz Grate	B	1	1	\$2,700.00
861-R2428	4" No-Hub - No Grate	B	1	1	\$1,200.00
861-R2428A	4" No-Hub - ARE Grate	B	1	1	\$1,418.00
861-R2428N	4" No-Hub - Nikl-Brnz Grate	B	1	1	\$2,700.00
861-RF2228	2" No-Hub - No Grate, w/ Flange	B	1	1	\$1,300.00
861-RF2228A	2" No-Hub - ARE Grate, w/ Flange	B	1	1	\$1,518.00
861-RF2228N	2" No-Hub - Nikl-Brnz Grate, w/ Flange	B	1	1	\$2,800.00
861-RF2328	3" No-Hub - No Grate, w/ Flange	B	1	1	\$1,300.00
861-RF2328A	3" No-Hub - ARE Grate, w/ Flange	B	1	1	\$1,518.00
861-RF2328N	3" No-Hub - Nikl-Brnz Grate, w/ Flange	B	1	1	\$2,800.00
861-RF2428	4" No-Hub - No Grate, w/ Flange	B	1	1	\$1,300.00
861-RF2428A	4" No-Hub - ARE Grate, w/ Flange	B	1	1	\$1,518.00
861-RF2428N	4" No-Hub - Nikl-Brnz Grate, w/ Flange	B	1	1	\$2,800.00
<b>ACCESSORIES</b>					
861-BR2	Aluminum Bucket	B	1	1	\$348.00
861-CR2	Collar Clamp	B	1	1	\$300.00
861-GAR2F	A.R.E. Full Grate	B	1	6	\$218.00
861-GAR2H	A.R.E. Open-Half Grate	B	1	6	\$218.00
861-GAR2T	A.R.E. Open-Quarter Grate	B	1	6	\$218.00
861-GNR2F	Nickl-Brnz Full Grate	B	1	1	\$1,500.00
861-GNR2H	Nickl-Brnz Open-Half Grate	B	1	1	\$1,500.00
861-GNR2T	Nickl-Brnz Open-Quarter Grate	B	1	1	\$1,500.00
863-FACQ	Round Aluminum Condensate Funnel w/ Screws	BI	1	12	\$168.00
863-FNCQ	Round Nikl-Brnz Condensate Funnel w/ Screws	BI	1	12	\$370.00
863-FNOCQ	Oval Nikl-Brnz Condensate Funnel w/ Screws	BI	1	12	\$815.00
<b>TRAP PRIMER ADAPTER</b>					
861-TA22	2" No-Hub - 1/2" FIP	B	1	1	\$213.00
861-TA23	3" No-Hub - 1/2" FIP	B	1	1	\$213.00
861-TA24	4" No-Hub - 1/2" FIP	B	1	1	\$213.00

Supply

Drainage

Support

Specialties

Appendix

## Stainless Steel Floor Sink

### No-Hub Connection

Item Number	Item Description	Pkg Type	Min Qty	Case Qty	Price
<b>FLOOR SINKS</b>					
860-3SS	3" No-Hub - 6-3/4" Rnd Grate	BI	1	1	\$3,660.00
860-4SS	4" No-Hub - 8-7/8" Rnd Grate	BI	1	1	\$4,280.00
<b>ACCESSORIES</b>					
860-3SSS	6-3/4" Rnd Grate	B	1	1	\$929.00
860-4SSS	8-7/8" Rnd Grate	BI	1	1	\$1,299.00
860-4SSU	Debris Bucket For 860-4SS	BI	1	1	\$287.00



860-4SS



860-3SSS

Supply

Drainage

Support

Specialties

Appendix





# Specification Roof Drains

**Roof Drains**

**Promenade Drains**

**Scupper Drains**

**Accessories**





**868-1504**  
Page 275



**868-524B**  
Page 276



**868-F524**  
Page 276



**868-I4**  
Page 277



**868-123**  
Page 277



**868-824**  
Page 278



**868-2010**  
Page 278



**868-D1503**  
Page 280



**868-D824**  
Page 281



**868-R623I**  
Page 282



**868-S4A**  
Page 283



**868-N6F**  
Page 284



**868-N4S**  
Page 284



**868-V234**  
Page 284

## 15" Roof Drain - Alpha Series

### Cast Iron - No-Hub Connection

**Options:** Add suffix to item no. Add price to list

**H** = Undermount Hardware Kit: \$119.00; **U** = Underdeck Clamp Kit: \$229.00;

**S** = Sump Receiver: \$274.00; **E** = Adjustable Extension Assembly Kit: \$830.00;

**W** = 2" High External Water Dam: \$290.00; **P** = 2" High Internal Water Dam: \$290.00;

**A** = Aluminum Dome Strainer (1): \$290.00; **V** = Vandal-Resistant Dome: \$150.00;

1: In lieu of cast iron dome (standard)



868-1504

Item Number	Item Description	Pkg Type	Min Qty	Case Qty	Price
<b>ROOF DRAINS</b>					
868-1503	3" No-Hub w/ Cast Iron Dome Strainer	Bl	1	1	\$815.00
868-1504	4" No-Hub w/ Cast Iron Dome Strainer	Bl	1	1	\$815.00
868-1506	6" No-Hub w/ Cast Iron Dome Strainer	Bl	1	1	\$815.00
<b>ACCESSORIES</b>					
<b>868-15AD</b>	12-1/2" Aluminum Dome Strainer	Bl	1	1	\$290.00
868-15CD	12-1/2" Cast Iron Dome Strainer	Bl	1	1	\$205.00
868-15EXT	Adjustable Extension Assembly Kit	Bl	1	1	\$830.00
868-15S	Sump Receiver - 16ga Galvanized Steel	Bl	1	1	\$274.00
868-15SH	Undermount Hardware Kit: 4 Pieces Angle Bracket, Thread Rod, Nuts, Washers	Bl	1	10	\$119.00
868-15U	Underdeck Clamp Kit: 4 Pieces Thread Rod, Nuts, Washers, Two Clamping Bars	Bl	1	5	\$229.00
868-15WD	External Water Dam - 2" High	Bl	1	5	\$290.00

## 15" Roof Drain - Bravo Series

### Cast Iron - No-Hub Connection

**Options:** Add suffix to item no. Add price to list

**9** = 90-deg. Side Outlet Connection (1): \$486.00; **2** = 2" High SS Perforated Extension: \$734.00;

**4** = 4" High SS Perforated Extension: \$734.00; **D** = 6" High SS Perforated Dome Cover: \$1,750.00;

**P** = Top Mount Sump Receiver: \$415.00; **S** = Sump Receiver: \$260.00;

**C** = Underdeck Clamp: \$230.00; **E** = Adjustable Extension Assembly Kit: \$830.00;

**G** = 2" High SS Gravel Guard: \$742.00; **H** = 4" High Internal Water Dam: \$400.00;

**W** = 2" High External Water Dam: \$183.00;

1: Not available for 6" or 8" drains



868-522

Item Number	Item Description	Pkg Type	Min Qty	Case Qty	Price
<b>CAST IRON DOME</b>					
<b>868-523</b>	3" No-Hub w/ Cast Iron Dome Strainer	B	1	1	\$925.00
<b>868-524</b>	4" No-Hub w/ Cast Iron Dome Strainer	B	1	1	\$925.00
<b>868-526</b>	6" No-Hub w/ Cast Iron Dome Strainer	B	1	1	\$1,200.00
<b>868-528</b>	8" No-Hub w/ Cast Iron Dome Strainer	B	1	1	\$1,540.00

Supply

Drainage

Support

Specialties

Appendix



868-524B



868-5U

## 15" Roof Drain - Bravo Series (Cont)

### Cast Iron - No-Hub Connection

Item Number	Item Description	Pkg Type	Min Qty	Case Qty	Price
<b>POLY DOME</b>					
868-523B	3" No-Hub w/ Poly Dome Strainer	B	1	1	\$775.00
868-524B	4" No-Hub w/ Poly Dome Strainer	B	1	1	\$775.00
868-526B	6" No-Hub w/ Poly Dome Strainer	B	1	1	\$1,050.00
868-528B	8" No-Hub w/ Poly Dome Strainer	B	1	1	\$1,390.00
<b>ALUMINUM DOME</b>					
868-523A	3" No-Hub w/ Aluminum Dome Strainer	B	1	1	\$975.00
868-524A	4" No-Hub w/ Aluminum Dome Strainer	B	1	1	\$975.00
868-526A	6" No-Hub w/ Aluminum Dome Strainer	B	1	1	\$1,165.00
868-528A	8" No-Hub w/ Aluminum Dome Strainer	B	1	1	\$1,390.00
<b>ACCESSORIES</b>					
868-5AD	Aluminum Dome Strainer	B	1	1	\$300.00
868-5CD	Cast Iron Dome Strainer	BI	1	1	\$250.00
868-5EXT	Adjustable/Threaded Extension Assembly Kit	BI	1	1	\$830.00
868-5PD	ABS Dome Strainer	BI	1	1	\$150.00
868-5S	Sump Receiver - Coated Steel	BI	1	1	\$260.00
868-5SH	Top Mount Hardware Kit: Brackets, Screws	BI	1	1	\$100.00
868-5U	Underdeck Clamp Kit: Clamping Ring, Thread Rod, Nuts, Washers	BI	1	1	\$230.00
868-5WD	External Water Dam - 2" High	BI	1	1	\$183.00

## 15" Adjustable Weir Roof Drain

### Cast Iron - No-Hub Connection



868-F524

**Options:** Add suffix to item no. Add price to list

**9** = 90-deg. Side Outlet Connection (1): \$486.00; **2** = 2" High SS Perforated Extension: \$734.00;

**4** = 4" High SS Perforated Extension: \$734.00; **P** = Top Mount Sump Receiver: \$415.00;

**S** = Sump Receiver: \$260.00; **C** = Underdeck Clamp: \$230.00;

**E** = Adjustable Extension Assembly Kit: \$695.00; **G** = 2" High SS Gravel Guard: \$742.00;

1: Not available for 6" drains

Item Number	Item Description	Pkg Type	Min Qty	Case Qty	Price
<b>CAST IRON DOME</b>					
868-F523	3" No-Hub w/ Cast Iron Dome Strainer	B	1	1	\$1,650.00
868-F524	4" No-Hub w/ Cast Iron Dome Strainer	B	1	1	\$1,650.00
868-F526	6" No-Hub w/ Cast Iron Dome Strainer	B	1	1	\$1,650.00
<b>POLY DOME</b>					
868-F523B	3" No-Hub w/ Poly Dome Strainer	B	1	1	\$1,550.00
868-F524B	4" No-Hub w/ Poly Dome Strainer	B	1	1	\$1,550.00
868-F526B	6" No-Hub w/ Poly Dome Strainer	B	1	1	\$1,550.00
<b>ALUMINUM DOME</b>					
868-F523A	3" No-Hub w/ Aluminum Dome Strainer	B	1	1	\$1,910.00
868-F524A	4" No-Hub w/ Aluminum Dome Strainer	B	1	1	\$1,910.00
868-F526A	6" No-Hub w/ Aluminum Dome Strainer	B	1	1	\$1,910.00

## 11" Roof Drain

### Cast Iron - No-Hub Connection

**Options:** Add suffix to item no. Add price to list

**V** = Vandal-Resistant Dome: \$150.00; **W** = 2-3/16" High External Water Dam: \$210.00;

**P** = Steel Screen Installed Over Dome Strainer: \$140.00; **STP2** = 2" High Internal Water Dam: \$210.00;

**U** = Underdeck Clamp Kit: \$145.00; **S** = Sump Receiver: \$125.00;

**E** = Extension Collar Kit: \$140.00;



868-13

Item Number	Item Description	Pkg Type	Min Qty	Case Qty	Price
<b>ROOF DRAINS WITH POLY DOME STRAINER</b>					
868-13	3" No-Hub	BI	1	2	\$915.00
868-14	4" No-Hub	BI	1	2	\$915.00
<b>868-16</b>	6" No-Hub	BI	1	2	\$995.00
<b>ROOF DRAINS WITH ALUMINUM DOME STRAINER</b>					
868-13M	3" No-Hub	BI	1	1	\$1,207.00
868-14M	4" No-Hub	BI	1	2	\$1,207.00
<b>868-16M</b>	6" No-Hub	BI	1	1	\$1,310.00
<b>ACCESSORIES</b>					
<b>868-CCQ</b>	Under Deck Clamp Kit: 11" Epoxy-Coated Clamping Plate, Thread Rod, Nuts & Washers	BI	1	5	\$305.00
<b>868-ECQ</b>	Extension Collar Kit: 13" Extension Collar, Thread Rod, Nuts & Washers	BI	1	5	\$290.00
<b>868-MCCQ</b>	Epoxy-Coated Aluminum Replacement Gravel Guard	BI	1	10	\$370.00
<b>868-MDCQ</b>	Dome Strainer - 9-1/4" Diameter, Cast Aluminum	BI	1	1	\$350.00
<b>868-SCQ</b>	Sump Receiver: 11-1/2" Sump Receiver Plate	BI	1	10	\$230.00
<b>868-WDCQ</b>	Epoxy-Coated Aluminum External Water Dam, 2-3/16"	BI	1	1	\$450.00

## 10" Roof Drain

### Cast Iron - No-Hub Connection

**Options:** Add suffix to item no. Add price to list

**P** = Top Mount Sump Receiver: \$380.00; **S** = Sump Receiver: \$245.00;

**C** = Underdeck Clamp Kit: \$145.00; **W** = 2" High Internal Water Dam: \$365.00;



868-123

Item Number	Item Description	Pkg Type	Min Qty	Case Qty	Price
<b>CAST IRON DOME</b>					
<b>868-123</b>	3" No Hub w/ Cast Iron Dome Strainer	B	1	1	\$990.00
<b>868-124</b>	4" No Hub w/ Cast Iron Dome Strainer	B	1	1	\$990.00



868-F123

## 10" Weir Roof Drain

### Cast Iron No-Hub Connection

**Options:** Add suffix to item no. Add price to list

**P** = Top Mount Sump Receiver: \$380.00; **S** = Sump Receiver: \$245.00;

**C** = Underdeck Clamp Kit: \$145.00;

Item Number	Item Description	Pkg Type	Min Qty	Case Qty	Price
<b>ADJUSTABLE WEIR</b>					
868-F123	3" No Hub w/ Cast Iron Dome Strainer	B	1	1	\$1,200.00
868-F124	4" No Hub w/ Cast Iron Dome Strainer	B	1	1	\$1,200.00
<b>FIXED WEIR</b>					
868-M123	3" No Hub w/ Cast Iron Dome Strainer	B	1	1	\$1,200.00
868-M124	4" No Hub w/ Cast Iron Dome Strainer	B	1	1	\$1,200.00



868-824

## 8" Roof Drain

### Cast Iron - No-Hub Connection

**Options:** Add suffix to item no. Add price to list

**9** = 90-deg. Side Outlet Connection: \$310.00; **S** = Sump Receiver: \$245.00;

**C** = Underdeck Clamp Kit: \$150.00; **W** = 2" High Internal Water Dam: \$185.00;

**P** = SS Mesh Dome Cover: \$300.00;

Item Number	Item Description	Pkg Type	Min Qty	Case Qty	Price
<b>ALUMINUM DOME</b>					
868-823	3" No-Hub w/ Aluminum Dome Strainer	B	1	1	\$750.00
868-824	4" No-Hub w/ Aluminum Dome Strainer	B	1	1	\$750.00



868-2010

## 20" Large-Capacity Roof Drain

### Cast Iron - No-Hub Connection

**Options:** Add suffix to item no. Add price to list

**H** = Undermount Hardware Kit: \$404.00; **U** = Underdeck Clamp Kit: \$444.00;

**S** = Sump Receiver: \$726.00; **W** = 2" High External Water Dam: \$478.00;

Item Number	Item Description	Pkg Type	Min Qty	Case Qty	Price
<b>ROOF DRAINS</b>					
868-2010	10" No-Hub - Cast Iron Dome	BI	1	1	\$1,995.00
868-2012	12" No-Hub - Cast Iron Dome	BI	1	1	\$2,200.00

## 20" Large-Capacity Roof Drain (Cont)

### Cast Iron - No-Hub Connection

Item Number	Item Description	Pkg Type	Min Qty	Case Qty	Price
<b>ACCESSORIES</b>					
<b>868-20CD</b>	18-1/4" Diameter, Cast Iron	BI	1	1	\$540.00
868-20S	Sump Receiver	BI	1	1	\$800.00
868-20SH	Sump Receiver Hardware Kit	BI	1	1	\$450.00
868-20U	Underdeck Clamp Kit: 4 Pieces Thread Rod, Nuts, Washers, Two Clamping Bars	BI	1	1	\$460.00
<b>868-20WD</b>	External Water Dam - 2" High	BI	1	1	\$525.00

Supply

Drainage

Support

Specialties

Appendix



868-D1503

## 15" Roof Drain & Overflow - Alpha Series

### Cast Iron - No-Hub Connection

· 2" High external water dam (for overflow fixture) is standard

**Options:** Add suffix to item no. Add price to list

**A** = Aluminum Dome Strainer (1): \$474.00; **E** = Adjustable Extension Assembly Kit: \$1,660.00;

**H** = Undermount Hardware Kit: \$238.00; **P** = 2" High Internal Water Dam (2): N/C;

**U** = Underdeck Clamp Kit: \$458.00; **V** = Vandal-Resistant Dome: \$300.00;

1: In lieu of cast iron dome (standard) 2: In lieu of external water dam (for overflow fixture)

Item Number	Item Description	Pkg Type	Min Qty	Case Qty	Price
<b>ROOF DRAIN &amp; OVERFLOW</b>					
868-D1503	3" No-Hub Cast Iron Roof Drain & Overflow	BI	1	1	\$2,460.00
868-D1504	4" No-Hub Cast Iron Roof Drain & Overflow	BI	1	1	\$2,460.00
868-D1506	6" No-Hub Cast Iron Roof Drain & Overflow	BI	1	1	\$2,460.00
<b>ACCESSORIES</b>					
<b>868-15AD</b>	12-1/2" Aluminum Dome Strainer	BI	1	1	\$290.00
868-15CD	12-1/2" Cast Iron Dome Strainer	BI	1	1	\$205.00
868-15EXT	Adjustable Extension Assembly Kit	BI	1	1	\$830.00
868-15S2	Double Sump Receiver Only - 12ga Powder-Coated Steel	BI	1	1	\$787.00
868-15SH	Undermount Hardware Kit: 4 Pieces Angle Bracket, Thread Rod, Nuts, Washers	BI	1	10	\$119.00
868-15U	Underdeck Clamp Kit: 4 Pieces Thread Rod, Nuts, Washers, Two Clamping Bars	BI	1	5	\$229.00

## 15" Roof Drain & Overflow - Bravo Series

### Cast Iron - No-Hub Connection

· 4" High internal water dam (for overflow fixture) is standard. Can be cut/shortened per specifications

**Options:** Add suffix to item no. Add price to list

**2** = 2" High SS Perforated Extension: \$1,468.00; **4** = 4" High SS Perforated Extension: \$1,468.00;

**W** = 2" External Water Dam (1): \$225.00; **E** = Adjustable Extension Assembly Kit: \$1,660.00;

**G** = 2" High SS Gravel Guard: \$1,484.00;

1: In lieu of internal water dam (for overflow fixture)

Item Number	Item Description	Pkg Type	Min Qty	Case Qty	Price
<b>CAST IRON DOME</b>					
<b>868-D523</b>	3" No-Hub w/ Cast Iron Dome Strainer	B	1	1	\$2,750.00
<b>868-D524</b>	4" No-Hub w/ Cast Iron Dome Strainer	B	1	1	\$2,750.00
<b>868-D526</b>	6" No-Hub w/ Cast Iron Dome Strainer	B	1	1	\$3,400.00
<b>868-D528</b>	8" No-Hub w/ Cast Iron Dome Strainer	B	1	1	\$3,895.00



## 15" Roof Drain & Overflow - Bravo Series (Cont)

### Cast Iron - No-Hub Connection



868-D524B

Item Number	Item Description	Pkg Type	Min Qty	Case Qty	Price
<b>POLY DOME</b>					
868-D523B	3" No-Hub w/ Poly Dome Strainer	B	1	1	\$2,357.00
868-D524B	4" No-Hub w/ Poly Dome Strainer	B	1	1	\$2,357.00
868-D526B	6" No-Hub w/ Poly Dome Strainer	B	1	1	\$2,930.00
868-D528B	8" No-Hub w/ Poly Dome Strainer	B	1	1	\$3,500.00
<b>ALUMINUM DOME</b>					
868-D523A	3" No-Hub w/ Aluminum Dome Strainer	B	1	1	\$3,224.00
868-D524A	4" No-Hub w/ Aluminum Dome Strainer	B	1	1	\$3,224.00
868-D526A	6" No-Hub w/ Aluminum Dome Strainer	B	1	1	\$3,874.00
868-D528A	8" No-Hub w/ Aluminum Dome Strainer	B	1	1	\$4,369.00

## 8" Roof Drain & Overflow

### Cast Iron - No-Hub Connection



868-D824

· 4" High internal water dam (for overflow fixture). Can be cut/shortened per specifications

**Options:** Add suffix to item no. Add price to list

**9** = 90-deg. Side Outlet Connection: \$620.00; **C** = Underdeck Clamp: \$290.00;

Item Number	Item Description	Pkg Type	Min Qty	Case Qty	Price
868-D823	3" No-Hub w/ Aluminum Dome Strainer	B	1	1	\$1,500.00
868-D824	4" No-Hub w/ Aluminum Dome Strainer	B	1	1	\$1,500.00

Promenade Drain

Cast Iron - No-Hub Connection

Options: Add suffix to item no. Add price to list

2 = 2" High SS Perforated Extension: \$800.00; 4 = 4" High SS Perforated Extension: \$800.00;

9 = 90-deg. Side Outlet Connection (1): \$500.00; B = Sediment Bucket (2): \$250.00;

C = Underdeck Clamp: \$250.00; E = Adjustable Extension Assembly Kit: \$830.00;

P = Top Mount Sump Receiver: \$450.00; S = Sump Receiver: \$260.00;

X = Extra Heavy-Duty Grate: \$250.00;

1: Not available for 6" drains 2: Not available for drains with Adjustable Extension



868-R623I



868-R623IN



868-Q624IN

Item Number	Item Description	Pkg Type	Min Qty	Case Qty	Price
<b>ROUND DUCTILE STRAINER</b>					
868-R623I	3" No-Hub - 16" Ductile Iron Ring & Strainer	B	1	1	\$2,450.00
868-R624I	4" No-Hub - 16" Ductile Iron Ring & Strainer	B	1	1	\$2,450.00
868-R626I	6" No-Hub - 16" Ductile Iron Ring & Strainer	B	1	1	\$2,450.00
868-R628I	8" No-Hub - 16" Ductile Iron Ring & Strainer	B	1	1	\$2,450.00
<b>ROUND DUCTILE STRAINER - NICKEL-BRONZE VENEER</b>					
868-R623IN	3" No-Hub - 16-3/8" Ductile Iron w/ NB Veneer Ring & Strainer	B	1	1	\$4,890.00
868-R624IN	4" No-Hub - 16-3/8" Ductile Iron w/ NB Veneer Ring & Strainer	B	1	1	\$4,890.00
868-R626IN	6" No-Hub - 16-3/8" Ductile Iron w/ NB Veneer Ring & Strainer	B	1	1	\$4,890.00
868-R628IN	8" No-Hub - 16-3/8" Ductile Iron w/ NB Veneer Ring & Strainer	B	1	1	\$4,890.00
<b>SQUARE DUCTILE STRAINER</b>					
868-Q623I	3" No-Hub - 16" Ductile Iron Ring & Strainer	B	1	1	\$2,780.00
868-Q624I	4" No-Hub - 16" Ductile Iron Ring & Strainer	B	1	1	\$2,780.00
868-Q626I	6" No-Hub - 16" Ductile Iron Ring & Strainer	B	1	1	\$2,780.00
868-Q628I	8" No-Hub - 16" Ductile Iron Ring & Strainer	B	1	1	\$2,780.00
<b>SQUARE DUCTILE STRAINER - NICKEL-BRONZE VENEER</b>					
868-Q623IN	3" No-Hub - 16-3/8" Ductile Iron w/ NB Veneer Ring & Strainer	B	1	1	\$5,290.00
868-Q624IN	4" No-Hub - 16-3/8" Ductile Iron w/ NB Veneer Ring & Strainer	B	1	1	\$5,290.00
868-Q626IN	6" No-Hub - 16-3/8" Ductile Iron w/ NB Veneer Ring & Strainer	B	1	1	\$5,290.00
868-Q628IN	8" No-Hub - 16-3/8" Ductile Iron w/ NB Veneer Ring & Strainer	B	1	1	\$5,290.00

Supply

Drainage

Support

Specialties

Appendix

**Cast Iron - FIP Connection**

Item Number	Item Description	Pkg Type	Min Qty	Case Qty	Price
<b>ANGLE ALUMINUM STRAINER</b>					
868-S3A	3" FIP Scupper w/ Angled Aluminum Grate	BI	1	1	\$702.00
868-S4A	4" FIP Scupper w/ Angled Aluminum Grate	BI	1	1	\$702.00
868-S6A	6" FIP Scupper w/ Angled Aluminum Grate	BI	1	1	\$1,300.00
<b>FLUSH ALUMINUM STRAINER</b>					
868-S3F	3" FIP Scupper w/ Flush Aluminum Grate	BI	1	1	\$800.00
868-S4F	4" FIP Scupper w/ Flush Aluminum Grate	BI	1	1	\$800.00
868-S6F	6" FIP Scupper w/ Flush Aluminum Grate	BI	1	1	\$1,230.00



868-S4A



868-S4F

Supply

Drainage

Support

Specialties

Appendix

Supply

Drainage

Support

Specialties

Appendix



868-N3H



868-N6F

### Nickel-Bronze Downspout Nozzles

Item Number	Item Description	Pkg Type	Min Qty	Case Qty	Price
<b>NO-HUB CONNECTION</b>					
868-N3H	Downspout Nozzle 3" w/ Ring No-Hub Connection	BI	1	1	\$1,338.00
868-N4H	Downspout Nozzle 4" w/ Ring No-Hub Connection	BI	1	1	\$1,338.00
868-N6H	Downspout Nozzle 6" w/ Ring No-Hub Connection	BI	1	1	\$2,402.00
868-N8H	Downspout Nozzle 8" w/ Ring No-Hub Connection	BI	1	1	\$3,285.00
<b>FIP THREAD CONNECTION</b>					
868-N3F	Downspout Nozzle 3" w/ Ring FIP Thread Connection	BI	1	1	\$1,338.00
868-N4F	Downspout Nozzle 4" w/ Ring FIP Thread Connection	BI	1	1	\$1,338.00
<b>868-N6F</b>	Downspout Nozzle 6" w/ Ring FIP Thread Connection	BI	1	1	\$2,402.00
<b>868-N8F</b>	Downspout Nozzle 8" w/ Ring FIP Thread Connection	BI	1	1	\$3,285.00
<b>ACCESSORIES</b>					
868-NS3	3" Bird Screen w/ Screws	BI	1	1	\$84.00
868-NS4	4" Bird Screen w/ Screws	BI	1	1	\$100.00
868-NS6	6" Bird Screen w/ Screws	BI	1	1	\$115.00
<b>868-NS8</b>	8" Bird Screen w/ Screws	BI	1	1	\$135.00

### Stainless Steel Downspout Nozzle Cover



Item Number	Item Description	Pkg Type	Min Qty	Case Qty	Price
868-N3S	3", Hinged Cover	BI	1	1	\$3,604.00
868-N4S	4", Hinged Cover	BI	1	1	\$3,604.00
868-N6S	6", Hinged Cover	BI	1	1	\$3,801.00
868-N8S	8", Hinged Cover	BI	1	1	\$3,989.00

### Vent Cap



868-V234

#### Cast Iron - Set Screw Connection

Item Number	Item Description	Pkg Type	Min Qty	Case Qty	Price
868-V234	Cast Iron Vent Cap For 2", 3", Or 4" Pipe	BI	1	1	\$485.00

# Specification Cleanouts

**FinishLine™ Adjustable Cleanouts**

**Access Cover Cleanouts**

**Halo™ Cleanouts**

**Cleanout Fittings**

**Wall Cleanouts**

**Plugs**



FinishLine™ Cleanouts are adjustable both before and AFTER the concrete pour. The FinishLine virtually eliminates cleanouts set too low or not level. Installations are faster, easier, and more professional looking.



**834-4DNR**  
Page 287



**834-6DNR**  
Page 288



**834-3SSR**  
Page 290



**854-22IQ**  
Page



**854-22IS**  
Page



**851-24I**  
Page 296



**850-9I**  
Page 297



**822-C3DSR**  
Page 298



**853-T24I**  
Page 299



**873-36**  
Page 300



**971-99**  
Page 300

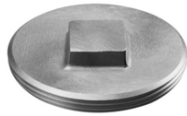

**876-RS30**  
Page 301

Cast Iron - No-Hub Connection

6-1/2" Tops

Options: Add suffix to item no. Add price to list

V = Vandal-Resistant Cover: \$23.00; S = Stamping: Specify Letters (1): \$75.00;

C = Carpet Marker: \$100.00; B = Brass Cleanout Plug (2): \$85.00;

Z = Complies with Buy American Act (3): \$125.00; H = Special-Duty Cover (15,000 lbs. safe load) (4): \$135.00;

1: Not available for iron covers 2: In lieu of polypro (standard) 3: For round nickel-bronze covers only 4: Not available for stainless steel covers

Item Number	Item Description	Pkg Type	Min Qty	Case Qty	Price
<b>ROUGH-IN FIXTURE</b>					
834-3DF	3" No-Hub	Bl	1	1	\$300.00
834-4DF	4" No-Hub	Bl	1	1	\$300.00
<b>FINISH FIXTURE</b>					
834-4DHIR	6-1/2" Rnd Ductile Iron Ring & Strainer	Bl	1	10	\$325.00
834-4DHNQ	6-5/8" Sqr Nikl-Brnz Ring & Strainer	Bl	1	10	\$600.00
834-4DHNR	6-1/2" Rnd Nikl-Brnz Ring & Strainer	Bl	1	10	\$500.00
834-4DHSQ	6-5/8" Sqr Stnls Steel Ring & Strainer	Bl	1	1	\$600.00
834-4DHSR	6-1/2" Rnd Stnls Steel Ring & Strainer	Bl	1	1	\$500.00
<b>COMPLETE ASSEMBLY</b>					
834-3DIR	3" No-Hub - 6-1/2" Rnd Ductile Iron Ring & Strainer	Bl	1	1	\$625.00
834-3DNQ	3" No-Hub - 6-5/8" Sqr Nikl-Brnz Ring & Strainer	Bl	1	1	\$900.00
834-3DNR	3" No-Hub - 6-1/2" Rnd Nikl-Brnz Ring & Strainer	Bl	1	1	\$800.00
834-3DSQ	3" No-Hub - 6-5/8" Sqr Stnls Steel Ring & Strainer	Bl	1	1	\$900.00
834-3DSR	3" No-Hub - 6-1/2" Rnd Stnls Steel Ring & Strainer	Bl	1	1	\$800.00
834-4DIR	4" No-Hub - 6-1/2" Rnd Ductile Iron Ring & Strainer	Bl	1	1	\$625.00
834-4DNQ	4" No-Hub - 6-5/8" Sqr Nikl-Brnz Ring & Strainer	Bl	1	1	\$900.00
834-4DNR	4" No-Hub - 6-1/2" Rnd Nikl-Brnz Ring & Strainer	Bl	1	1	\$800.00
834-4DSQ	4" No-Hub - 6-5/8" Sqr Stnls Steel Ring & Strainer	Bl	1	1	\$900.00
834-4DSR	4" No-Hub - 6-1/2" Rnd Stnls Steel Ring & Strainer	Bl	1	1	\$800.00
<b>ACCESSORIES</b>					
832-EX4CQ	Ductile Iron Extension Adapter - 2" Min - 4" Max	Bl	1	1	\$120.00
832-PCQ	Coring Plug Wrench	Bl	1	1	\$87.00
832-S4CQ	Two Adjustment Shims, Two 3/4" Screws	Bl	1	1	\$22.00
832-WCQ	Flexible Red Locating Bristles w/ Screw	Bl	1	1	\$26.00



834-3DF



834-4DHIR



834-3DIR



832-WCQ

Supply

Drainage

Support

Specialties

Appendix

Supply

Drainage

Support

Specialties

Appendix



834-49DF



834-6DHR



834-6DIR



832-P



834-63DF

## Cast Iron - No-Hub Connection

### 9" Tops

**Options:** Add suffix to item no. Add price to list

**V** = Vandal-Resistant Cover: \$23.00; **S** = Stamping: specify letters (1): \$75.00;

**C** = Carpet Marker: \$30.00; **B** = Brass Cleanout Plug (2): \$75.00;

**F** = Clamping Collar: \$149.00;

1: Not available for iron covers 2: In lieu of polypro (standard)

Item Number	Item Description	Pkg Type	Min Qty	Case Qty	Price
<b>ROUGH-IN FIXTURE</b>					
<b>834-49DF</b>	4" No-Hub	BI	1	1	\$600.00
834-6DF	6" No-Hub	BI	1	1	\$600.00
<b>FINISH FIXTURE</b>					
834-6DHIR	9" Rnd Iron Ring & Strainer	BI	1	1	\$700.00
834-6DHNR	9" Rnd Nikl-Brnz Ring & Strainer	BI	1	1	\$1,100.00
834-6DHSR	9" Rnd Stnls Steel Ring & Strainer	BI	1	1	\$1,100.00
<b>COMPLETE ASSEMBLY</b>					
<b>834-49DIR</b>	4" No-Hub - 9" Rnd Ductile Iron Ring & Strainer	BI	1	1	\$1,300.00
834-49DNR	4" No-Hub - 9" Rnd Nikl-Brnz Ring & Strainer	BI	1	1	\$1,700.00
<b>834-49DSR</b>	4" No-Hub - 9" Rnd Stnls Steel Ring & Strainer	BI	1	1	\$1,700.00
834-6DIR	6" No-Hub - 9" Rnd Ductile Iron Ring & Strainer	BI	1	1	\$1,300.00
834-6DNR	6" No-Hub - 9" Rnd Nikl-Brnz Ring & Strainer	BI	1	1	\$1,700.00
834-6DSR	6" No-Hub - 9" Rnd Stnls Steel Ring & Strainer	BI	1	1	\$1,700.00
<b>ACCESSORIES</b>					
<b>832-PCQ</b>	Coring Plug Wrench	BI	1	1	\$87.00
<b>832-WCQ</b>	Flexible Red Locating Bristles w/ Screw	BI	1	1	\$26.00

## Cast Iron - Push-Joint Connection

### 6-1/2" Tops

**Options:** Add suffix to item no. Add price to list

**V** = Vandal-Resistant Cover: \$23.00; **S** = Stamping: Specify Letters (1): \$75.00;

**C** = Carpet Marker: \$100.00; **B** = Brass Cleanout Plug (2): \$85.00;

**Z** = Complies with Buy American Act (3): \$125.00; **P** = Push-joint Gasket to fit Sch. 40 ABS/PVC Pipe: \$25.00;

**H** = Special-Duty Cover (15,000 lbs. safe load) (4): \$135.00;

1: Not available for iron covers. 2: In lieu of polypro (standard) 3: For round nickel-bronze covers only 4: Not available for stainless steel covers

Item Number	Item Description	Pkg Type	Min Qty	Case Qty	Price
<b>ROUGH-IN FIXTURE</b>					
834-63DF	3" PJ Conn.	BI	1	1	\$300.00
834-64DF	4" PJ Conn.	BI	1	1	\$300.00



**Cast Iron - Push-Joint Connection (Cont)**

**6-1/2" Tops**

Item Number	Item Description	Pkg Type	Min Qty	Case Qty	Price
<b>FINISH FIXTURE</b>					
834-4DHIR	6-1/2" Rnd Ductile Iron Ring & Strainer	BI	1	10	\$325.00
834-4DHNQ	6-5/8" Sqr Nikl-Brnz Ring & Strainer	BI	1	10	\$600.00
834-4DHNR	6-1/2" Rnd Nikl-Brnz Ring & Strainer	BI	1	10	\$500.00
834-4DHSQ	6-5/8" Sqr Stnls Steel Ring & Strainer	BI	1	1	\$600.00
834-4DHSR	6-1/2" Rnd Stnls Steel Ring & Strainer	BI	1	1	\$500.00
<b>COMPLETE ASSEMBLY</b>					
834-63DIR	3" PJ Conn. - 6-1/2" Rnd Ductile Iron Ring & Strainer	BI	1	1	\$625.00
834-63DNQ	3" PJ Conn. - 6-5/8" Sqr Nikl-Brnz Ring & Strainer	BI	1	1	\$900.00
834-63DNR	3" PJ Conn. - 6-1/2" Rnd Nikl-Brnz Ring & Strainer	BI	1	1	\$800.00
834-63DSQ	3" PJ Conn. - 6-5/8" Sqr Stnls Steel Ring & Strainer	BI	1	1	\$900.00
834-63DSR	3" PJ Conn. - 6-1/2" Rnd Stnls Steel Ring & Strainer	BI	1	1	\$800.00
834-64DIR	4" PJ Conn. - 6-1/2" Rnd Ductile Iron Ring & Strainer	BI	1	1	\$625.00
834-64DNQ	4" PJ Conn. - 6-5/8" Sqr Nikl-Brnz Ring & Strainer	BI	1	1	\$900.00
834-64DNR	4" PJ Conn. - 6-1/2" Rnd Nikl-Brnz Ring & Strainer	BI	1	1	\$800.00
834-64DSQ	4" PJ Conn. - 6-5/8" Sqr Stnls Steel Ring & Strainer	BI	1	1	\$900.00
834-64DSR	4" PJ Conn. - 6-1/2" Rnd Stnls Steel Ring & Strainer	BI	1	1	\$800.00
<b>ACCESSORIES</b>					
832-EX4CQ	Ductile Iron Extension Adapter - 2" Min - 4" Max	BI	1	1	\$120.00
832-PCQ	Coring Plug Wrench	BI	1	1	\$87.00
832-S4CQ	Two Adjustment Shims, Two 3/4" Screws	BI	1	1	\$22.00
832-WCQ	Flexible Red Locating Bristles w/ Screw	BI	1	1	\$26.00



834-4DHIR



834-63DNQ

**Stainless Steel - No-Hub Connection**

**6-1/2" Tops**

**Options:** Add suffix to item no. Add price to list  
**V** = Vandal-Resistant Cover: \$23.00;

Item Number	Item Description	Pkg Type	Min Qty	Case Qty	Price
<b>ROUGH-IN FIXTURE</b>					
834-3SF	3" Hub	BI	1	1	\$1,500.00
834-4SF	4" Hub	BI	1	1	\$1,500.00
<b>FINISH FIXTURE</b>					
834-4SHSQ	6-5/8" Sqr Stnls Steel Ring & Strainer	BI	1	1	\$1,500.00
834-4SHSR	6-1/2" Rnd Stnls Steel Ring & Strainer	BI	1	1	\$1,200.00



834-3SF



834-4SHSR

Supply

Drainage

Support

Specialties

Appendix

Supply

Drainage

Support

Specialties

Appendix



834-3SSR

## Stainless Steel - No-Hub Connection (Cont)

### 6-1/2" Tops

Item Number	Item Description	Pkg Type	Min Qty	Case Qty	Price
<b>COMPLETE ASSEMBLY</b>					
834-3SSQ	3" No-Hub - 6-5/8" Sqr Stnls Steel Ring & Strainer	BI	1	1	\$3,000.00
834-3SSR	3" No-Hub - 6-1/2" Rnd Stnls Steel Ring & Strainer	BI	1	1	\$2,700.00
834-4SSQ	4" No-Hub - 6-5/8" Sqr Stnls Steel Ring & Strainer	BI	1	1	\$3,000.00
834-4SSR	4" No-Hub - 6-1/2" Rnd Stnls Steel Ring & Strainer	BI	1	1	\$2,700.00
<b>ACCESSORIES</b>					
832-PCQ	Coring Plug Wrench	BI	1	1	\$87.00
832-S4CQ	Two Adjustment Shims, Two 3/4" Screws	BI	1	1	\$22.00
832-WCQ	Flexible Red Locating Bristles w/ Screw	BI	1	1	\$26.00

## Cast Iron - No-Hub Connection

### Nickel-Bronze Cover

**Options:** Add suffix to item no. Add price to list

**A** = Acid-Resistant Epoxy Coated Cast Iron: \$335.00; **B** = Brass Cleanout Plug (1): \$153.00;  
**F** = Anchor Flange with Clamping Collar: \$125.00; **C** = Nickel-Bronze Carpet Clamp: \$295.00;  
**M** = Carpet Marker: \$75.00;

1: In lieu of ABS (standard)



854-24NR

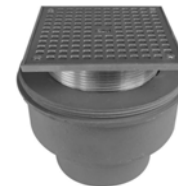

854-24NQ

Item Number	Item Description	Pkg Type	Min Qty	Case Qty	Price
<b>ROUND COVER</b>					
854-23NR	3" No-Hub - 5-5/8" Nickel-Bronze Ring & Cover	B	1	1	\$800.00
854-24NR	4" No-Hub - 5-5/8" Nickel-Bronze Ring & Cover	B	1	1	\$800.00
<b>SQUARE COVER</b>					
854-23NQ	3" No-Hub - 5-5/8" Nickel-Bronze Ring & Cover	B	1	1	\$920.00
854-24NQ	4" No-Hub - 5-5/8" Nickel-Bronze Ring & Cover	B	1	1	\$920.00

## Cast Iron - No-Hub Connection

### Stainless Steel Cover

**Options:** Add suffix to item no. Add price to list

**A** = Acid-Resistant Epoxy Coated Cast Iron: \$335.00; **B** = Brass Cleanout Plug (1): \$153.00;  
**F** = Anchor Flange with Clamping Collar: \$125.00; **M** = Carpet Marker: \$75.00;

1: In lieu of ABS (standard)



854-24SR

Item Number	Item Description	Pkg Type	Min Qty	Case Qty	Price
<b>ROUND COVER</b>					
854-23SR	3" No-Hub - 5-5/8" Stainless Steel Ring & Cover	B	1	1	\$1,000.00
854-24SR	4" No-Hub - 5-5/8" Stainless Steel Ring & Cover	B	1	1	\$1,000.00

Supply

Drainage

Support

Specialties

Appendix



854-24I



854-22IQ

### Cast Iron - No-Hub Connection

#### Ductile Iron Cover

**Options:** Add suffix to item no. Add price to list

**A** = Acid-Resistant Epoxy Coated Cast Iron: \$335.00; **B** = Brass Cleanout Plug (1): \$153.00;  
**F** = Anchor Flange with Clamping Collar: \$125.00; **C** = Nickel-Bronze Carpet Clamp: \$295.00;  
**M** = Carpet Marker: \$75.00;

1: In lieu of ABS (standard)

Item Number	Item Description	Pkg Type	Min Qty	Case Qty	Price
<b>ROUND COVER</b>					
854-23I	3" No-Hub - 5-1/4" Ductile Iron Ring & Cover	B	1	1	\$700.00
854-24I	4" No-Hub - 5-1/4" Ductile Iron Ring & Cover	B	1	1	\$700.00
854-26I	6" No-Hub - 8-1/4" Ductile Iron Ring & Cover	B	1	1	\$1,500.00
854-28I	8" No-Hub - 9-1/4" Ductile Iron Ring & Cover	B	1	1	\$1,775.00
<b>SQUARE COVER</b>					
854-23IQ	3" No-Hub - 5-1/4" Ductile Iron Ring & Cover	B	1	1	\$800.00
854-24IQ	4" No-Hub - 5-1/4" Ductile Iron Ring & Cover	B	1	1	\$800.00

### Cast Iron - No-Hub Connection

#### Ductile Iron Cover with Nickel-Bronze Veneer

**Options:** Add suffix to item no. Add price to list

**A** = Acid-Resistant Epoxy Coated Cast Iron: \$335.00; **B** = Brass Cleanout Plug (1): \$153.00;  
**F** = Anchor Flange with Clamping Collar: \$125.00; **C** = Nickel-Bronze Carpet Clamp: \$295.00;  
**M** = Carpet Marker: \$75.00;

1: In lieu of ABS (standard)



854-24IN



854-22INQ

Item Number	Item Description	Pkg Type	Min Qty	Case Qty	Price
<b>ROUND COVER</b>					
854-23IN	3" No-Hub - 5-5/8" Ductile Iron w/ NB Veneer Ring & Cover	B	1	1	\$900.00
854-24IN	4" No-Hub - 5-5/8" Ductile Iron w/ NB Veneer Ring & Cover	B	1	1	\$900.00
854-26IN	6" No-Hub - 8-3/4" Ductile Iron w/ NB Veneer Ring & Cover	B	1	1	\$1,700.00
854-28IN	8" No-Hub - 9-3/4" Ductile Iron w/ NB Veneer Ring & Cover	B	1	1	\$1,975.00
<b>SQUARE COVER</b>					
854-23INQ	3" No-Hub - 5-5/8" Ductile Iron w/ NB Veneer Ring & Cover	B	1	1	\$920.00
854-24INQ	4" No-Hub - 5-5/8" Ductile Iron w/ NB Veneer Ring & Cover	B	1	1	\$920.00

## Cast Iron - No-Hub Connection

### Ductile Iron Cover with Stainless Steel Veneer

**Options:** Add suffix to item no. Add price to list

**A** = Acid-Resistant Epoxy Coated Cast Iron: \$335.00; **B** = Brass Cleanout Plug (1): \$153.00;

**F** = Anchor Flange with Clamping Collar: \$125.00; **M** = Carpet Marker: \$75.00;

1: In lieu of ABS (standard)



854-22IS

Item Number	Item Description	Pkg Type	Min Qty	Case Qty	Price
<b>ROUND COVER</b>					
854-23IS	3" No-Hub - 5-5/8" Ductile Iron w/ SS Veneer Ring & Cover	B	1	1	\$1,000.00
854-24IS	4" No-Hub - 5-5/8" Ductile Iron w/ SS Veneer Ring & Cover	B	1	1	\$1,000.00
854-26IS	6" No-Hub - 8-3/4" Ductile Iron w/ SS Veneer Ring & Cover	B	1	1	\$1,900.00
854-28IS	8" No-Hub - 9-3/4" Ductile Iron w/ SS Veneer Ring & Cover	B	1	1	\$2,200.00

## Cast Iron - Push-Joint Connection

### Nickel-Bronze Cover

**Options:** Add suffix to item no. Add price to list

**A** = Acid-Resistant Epoxy Coated Cast Iron: \$335.00; **B** = Brass Cleanout Plug (1): \$153.00;

**F** = Anchor Flange with Clamping Collar: \$125.00; **C** = Nickel-Bronze Carpet Clamp: \$295.00;

**M** = Carpet Marker: \$75.00;

1: In lieu of ABS (standard)



854-64NR



854-64NQ

Item Number	Item Description	Pkg Type	Min Qty	Case Qty	Price
<b>ROUND COVER</b>					
854-63NR	3" PJ Conn. - 5-5/8" Nickel-Bronze Ring & Cover	B	1	1	\$800.00
854-64NR	4" PJ Conn. - 5-5/8" Nickel-Bronze Ring & Cover	B	1	1	\$800.00
<b>SQUARE COVER</b>					
854-63NQ	3" PJ Conn. - 5-5/8" Nickel-Bronze Ring & Cover	B	1	1	\$920.00
854-64NQ	4" PJ Conn. - 5-5/8" Nickel-Bronze Ring & Cover	B	1	1	\$920.00

Supply

Drainage

Support

Specialties

Appendix



854-64SR

### Cast Iron - Push-Joint Connection Stainless Steel Cover

**Options:** Add suffix to item no. Add price to list

**A** = Acid-Resistant Epoxy Coated Cast Iron: \$335.00; **B** = Brass Cleanout Plug (1): \$153.00;

**F** = Anchor Flange with Clamping Collar: \$125.00; **M** = Carpet Marker: \$75.00;

1: In lieu of ABS (standard)

Item Number	Item Description	Pkg Type	Min Qty	Case Qty	Price
<b>ROUND COVER</b>					
854-63SR	3" PJ Conn. - 5-5/8" Stainless Steel Ring & Cover	B	1	1	\$1,000.00
854-64SR	4" PJ Conn. - 5-5/8" Stainless Steel Ring & Cover	B	1	1	\$1,000.00

### Cast Iron - Push-Joint Connection Ductile Iron Cover

**Options:** Add suffix to item no. Add price to list

**A** = Acid-Resistant Epoxy Coated Cast Iron: \$335.00; **B** = Brass Cleanout Plug (1): \$153.00;

**F** = Anchor Flange with Clamping Collar: \$125.00; **C** = Nickel-Bronze Carpet Clamp: \$295.00;

**M** = Carpet Marker: \$75.00;

1: In lieu of ABS (standard)



854-62I



854-62IQ

Item Number	Item Description	Pkg Type	Min Qty	Case Qty	Price
<b>ROUND COVER</b>					
854-63I	3" PJ Conn. - 5-1/4" Ductile Iron Ring & Cover	B	1	1	\$700.00
854-64I	4" PJ Conn. - 5-1/4" Ductile Iron Ring & Cover	B	1	1	\$700.00
854-66I	6" PJ Conn. - 8-1/4" Ductile Iron Ring & Cover	B	1	1	\$1,500.00
854-68I	8" PJ Conn. - 9-1/4" Ductile Iron Ring & Cover	B	1	1	\$1,775.00
<b>SQUARE COVER</b>					
854-63IQ	3" PJ Conn. - 5-1/4" Ductile Iron Ring & Cover	B	1	1	\$800.00
854-64IQ	4" PJ Conn. - 5-1/4" Ductile Iron Ring & Cover	B	1	1	\$800.00

## Cast Iron - Push-Joint Connection

### Ductile Iron Cover with Nickel-Bronze Veneer

**Options:** Add suffix to item no. Add price to list

**A** = Acid-Resistant Epoxy Coated Cast Iron: \$335.00; **B** = Brass Cleanout Plug (1): \$153.00;  
**F** = Anchor Flange with Clamping Collar: \$125.00; **C** = Nickel-Bronze Carpet Clamp: \$295.00;  
**M** = Carpet Marker: \$75.00;

1: In lieu of ABS (standard)

Item Number	Item Description	Pkg Type	Min Qty	Case Qty	Price
<b>ROUND COVER</b>					
854-63IN	3" PJ Conn. - 5-5/8" Ductile Iron w/ NB Veneer Ring & Cover	B	1	1	\$900.00
854-64IN	4" PJ Conn. - 5-5/8" Ductile Iron w/ NB Veneer Ring & Cover	B	1	1	\$900.00
854-66IN	6" PJ Conn. - 8-3/4" Ductile Iron w/ NB Veneer Ring & Cover	B	1	1	\$1,700.00
854-68IN	8" PJ Conn. - 9-3/4" Ductile Iron w/ NB Veneer Ring & Cover	B	1	1	\$1,975.00
<b>SQUARE COVER</b>					
854-63INQ	3" PJ Conn. - 5-5/8" Ductile Iron w/ NB Veneer Ring & Cover	B	1	1	\$920.00
854-64INQ	4" PJ Conn. - 5-5/8" Ductile Iron w/ NB Veneer Ring & Cover	B	1	1	\$800.00



854-62IN



854-62INQ

## Cast Iron - Push-Joint Connection

### Ductile Iron Cover with Stainless Steel Veneer

**Options:** Add suffix to item no. Add price to list

**A** = Acid-Resistant Epoxy Coated Cast Iron: \$335.00; **B** = Brass Cleanout Plug (1): \$153.00;  
**F** = Anchor Flange with Clamping Collar: \$125.00; **M** = Carpet Marker: \$75.00;

1: In lieu of ABS (standard)

Item Number	Item Description	Pkg Type	Min Qty	Case Qty	Price
<b>ROUND COVER</b>					
854-63IS	3" PJ Conn. - 5-5/8" Ductile Iron w/ SS Veneer Ring & Cover	B	1	1	\$1,000.00
854-64IS	4" PJ Conn. - 5-5/8" Ductile Iron w/ SS Veneer Ring & Cover	B	1	1	\$1,000.00
854-66IS	6" PJ Conn. - 8-3/4" Ductile Iron w/ SS Veneer Ring & Cover	B	1	1	\$1,900.00
854-68IS	8" PJ Conn. - 9-3/4" Ductile Iron w/ SS Veneer Ring & Cover	B	1	1	\$2,200.00



854-62IS

Supply

Drainage

Support

Specialties

Appendix



851-24N



851-24I



851-64N



851-64I

### Cast Iron - No-Hub Connection

**Options:** Add suffix to item no. Add price to list

**V** = Vandal-Resistant Cover: \$23.00; **S** = Stamping: Specify Letters (1): \$75.00;

**C** = Carpet Marker (1): \$75.00;

1: Not available for cast iron covers

Item Number	Item Description	Pkg Type	Min Qty	Case Qty	Price
<b>NICKEL-BRONZE COVER</b>					
851-24N	4" Cast Iron No-Hub - 6" Rnd Ring & Cover	BI	1	2	\$900.00
<b>TENZ-ALLOY COVER</b>					
851-24T	4" Cast Iron No-Hub - 6" Rnd Ring & Cover	BI	1	2	\$550.00
<b>CAST IRON COVER</b>					
851-24I	4" Cast Iron No-Hub - 6" Rnd Ring & Cover	BI	1	2	\$425.00

### Cast Iron - Push-Joint Connection

**Options:** Add suffix to item no. Add price to list

**V** = Vandal-Resistant Cover: \$23.00; **S** = Stamping: Specify Letters (1): \$75.00;

**C** = Carpet Marker (1): \$75.00; **P** = Push-Joint Gasket to fit Sch. 40 ABS/PVC Pipe (2): \$25.00;

1: Not available for cast iron covers 2: For 4" cleanouts only

Item Number	Item Description	Pkg Type	Min Qty	Case Qty	Price
<b>NICKEL-BRONZE COVER</b>					
851-64N	4" Cast Iron PJ Conn. - 6" Rnd Ring & Cover	BI	1	2	\$900.00
851-66N	6" Cast Iron PJ Conn. - 8-3/8" Rnd Ring & Cover	BI	1	2	\$2,300.00
<b>TENZ-ALLOY COVER</b>					
851-64T	4" Cast Iron PJ Conn. - 6" Rnd Ring & Cover	BI	1	2	\$550.00
851-66T	6" Cast Iron PJ Conn. - 8-3/8" Rnd Ring & Cover	BI	1	2	\$1,600.00
<b>CAST IRON COVER</b>					
851-64I	4" Cast Iron PJ Conn. - 6" Rnd Ring & Cover	BI	1	2	\$425.00
851-66I	6" Cast Iron PJ Conn. - 8-3/8" Rnd Ring & Cover	BI	1	2	\$1,600.00



## Heavy-Duty Cleanout Housing

### Double Flanged

Item Number	Item Description	Pkg Type	Min Qty	Case Qty	Price
<b>CAST IRON</b>					
850-9I	8-1/2" Inner Diam, w/ Lifting Device	BI	1	1	\$1,700.00
<b>NB LAMINATED CAST IRON</b>					
850-9IN	8-1/2" Inner Diam, w/ Lifting Device	BI	1	1	\$2,400.00



850-9I



850-9IN

Supply

Drainage

Support

Specialties

Appendix

Supply

Drainage

Support

Specialties

Appendix



822-C3DNQ



822-C3DSR

## Halo™ Adjustable Cleanouts

### Cast Iron - No-Hub Connection

· Halo cleanout fixtures include 882-ST302 mechanical sealing plug

**Options:** Add suffix to item no. Add price to list

**V** = Vandal-Resistant Cover: \$23.00; **S** = Stamping: Specify Letters: \$75.00;

**C** = Carpet Marker: \$75.00; **Z** = Complies with Buy American Act (1): \$125.00;

1: For round nickel-bronze covers only

Item Number	Item Description	Pkg Type	Min Qty	Case Qty	Price
<b>NICKEL-BRONZE RING &amp; COVER</b>					
822-C3DNQ	3" No-Hub - 5-7/8" Sqr Ring & Cover	BI	1	1	\$770.00
822-C3DNR	3" No-Hub - 5-1/2" Rnd Ring & Cover	BI	1	4	\$620.00
<b>STAINLESS STEEL RING &amp; COVER</b>					
822-C3DSQ	3" No-Hub - 5-7/8" Sqr Ring & Cover	BI	1	1	\$770.00
822-C3DSR	3" No-Hub - 5-1/2" Rnd Ring & Cover	BI	1	1	\$620.00

## FinishLine Halo™ Adjustable Cleanouts

### Cast Iron - No-Hub Connection

· Halo cleanout fixtures include 882-ST302 mechanical sealing plug

**Options:** Add suffix to item no. Add price to list

**V** = Vandal-Resistant Cover: \$23.00; **S** = Stamping: Specify Letters: \$75.00;

**C** = Carpet Marker: \$75.00; **Z** = Complies with Buy American Act (1): \$125.00;

1: For round nickel-bronze covers only



822-C3DF



834-3DHNR



822-CF3DNQ

Item Number	Item Description	Pkg Type	Min Qty	Case Qty	Price
<b>ROUGH-IN FIXTURE</b>					
822-C3DF	3" No-Hub	BI	1	1	\$360.00
<b>FINISH FIXTURE</b>					
834-3DHNQ	5-7/8" Sqr Nikl-Brnz Ring & Cover	BI	1	1	\$480.00
834-3DHNR	5-1/2" Rnd Nikl-Brnz Ring & Cover	BI	1	1	\$340.00
834-3DHSQ	5-7/8" Sqr Stnls Steel Ring & Cover	BI	1	1	\$480.00
834-3DHSR	5-1/2" Rnd Stnls Steel Ring & Cover	BI	1	1	\$340.00
<b>COMPLETE ASSEMBLY</b>					
822-CF3DNQ	3" No-Hub - 5-7/8" Sqr Nikl-Brnz Ring & Cover	BI	1	1	\$840.00
822-CF3DNR	3" No-Hub - 5-1/2" Rnd Nikl-Brnz Ring & Cover	BI	1	1	\$700.00
822-CF3DSQ	3" No-Hub - 5-7/8" Sqr Stnls Steel Ring & Cover	BI	1	1	\$840.00
822-CF3DSR	3" No-Hub - 5-1/2" Rnd Stnls Steel Ring & Cover	BI	1	1	\$700.00

**Cleanout Tees**

**Cast Iron - No-Hub Connection**

Item Number	Item Description	Pkg Type	Min Qty	Case Qty	Price
853-T23I	3" No-Hub w/ Brass Plug	BI	1	6	\$400.00
853-T24I	4" No-Hub w/ Brass Plug	BI	1	4	\$600.00
853-T26I	6" No-Hub w/ Brass Plug	BI	1	1	\$1,000.00
853-T28I	8" No-Hub w/ Brass Plug	BI	1	1	\$2,000.00



853-T24I

**Cleanout Ferrules**

**Cleanout Ferrules**

Item Number	Item Description	Pkg Type	Min Qty	Case Qty	Price
853-F23I	3" No-Hub w/ Brass Plug	BI	1	27	\$200.00
853-F24I	4" No-Hub w/ Brass Plug	BI	1	16	\$275.00
853-F26I	6" No-Hub w/ Brass Plug	BI	1	4	\$550.00



853-F23I

Supply

Drainage

Support

Specialties

Appendix

Supply

Drainage

Support

Specialties

Appendix



870-93

### Cleanout Covers

#### Heavy-Duty Stainless Steel

**Options:** Add suffix to item no. Add price to list  
**S** = Stamping: Specify Letters (1): \$75.00;

1: Not available for cast iron covers

Item Number	Item Description	Pkg Type	Min Qty	Case Qty	Price
<b>16-GA COVER</b>					
870-93	3" Diameter	BI	10	10	\$21.00
870-94	4" Diameter	BI	10	10	\$34.00
870-95	5" Diameter	BI	10	10	\$75.00
870-96	6" Diameter	BI	10	10	\$55.00
870-98	8" Diameter	BI	10	10	\$75.00

### Cleanout Cover Kits

#### Stainless Steel



873-8



873-36

Item Number	Item Description	Pkg Type	Min Qty	Case Qty	Price
<b>20-GA COVER WITH SCREW</b>					
873-10	10" Cover, 3-1/2" Screw	B	1	1	\$86.00
873-6	6" Cover, 3-1/2" Screw	BI	1	1	\$57.00
873-8	8" Cover, 3-1/2" Screw	BI	1	1	\$77.00
<b>20-GA COVER WITH SCREW AND BRASS PLUG</b>					
873-256	6" Cover, 2-1/2" Plug, 3-1/2" Screw	BI	1	1	\$116.00
873-26	6" Cover, 2" Plug, 3-1/2" Screw	BI	1	1	\$103.00
873-356	6" Cover, 3-1/2" Plug, 3-1/2" Screw	BI	1	1	\$196.00
873-36	6" Cover, 3" Plug, 3-1/2" Screw	BI	1	1	\$140.00
873-48	8" Cover, 4" Plug, 3-1/2" Screw	BI	1	1	\$213.00
873-610	10" Cover, 6" Plug, 3-1/2" Screw	BI	1	1	\$594.00
873-810	10" Cover, 8" Plug, 3-1/2" Screw	BI	1	1	\$820.00

### Square Access Panels



971-99

Item Number	Item Description	Pkg Type	Min Qty	Case Qty	Price
971-77	7" x 7", Metal	B	1	1	\$793.00
971-99	9" x 9", Metal	B	1	8	\$1,161.00

**Brass - Slotted**

· Plugs are tapped 1/4"-20 for cover screw

Item Number	Item Description	Pkg Type	Min Qty	Case Qty	Price
876-SL15	1-1/2"	BI	10	10	\$55.00
876-SL20	2"	BI	10	10	\$79.00
876-SL25	2-1/2"	BI	10	10	\$96.00
876-SL30	3"	BI	10	10	\$114.00
876-SL35	3-1/2"	BI	10	10	\$170.00
876-SL40	4"	BI	10	10	\$200.00
876-SL60	6"	BI	10	10	\$660.00
876-SL80	8"	BI	10	10	\$1,334.00

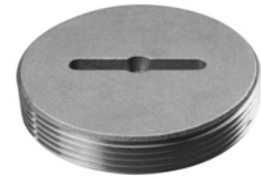

876-SL25

**Brass - Square-Head**

Item Number	Item Description	Pkg Type	Min Qty	Case Qty	Price
<b>RAISED SQUARE</b>					
876-RS15	1-1/2"	BI	10	10	\$55.00
876-RS20	2"	BI	10	10	\$79.00
876-RS25	2-1/2"	BI	10	10	\$96.00
876-RS30	3"	BI	10	10	\$114.00
876-RS35	3-1/2"	BI	10	10	\$170.00
876-RS40	4"	BI	10	10	\$185.00
876-RS50	5"	BI	10	10	\$416.00
876-RS60	6"	BI	10	10	\$660.00
876-RS80	8"	BI	10	10	\$1,334.00
<b>COUNTERSUNK SQUARE</b>					
876-CS15	1-1/2"	BI	10	10	\$55.00
876-CS20	2"	BI	10	10	\$79.00
876-CS25	2-1/2"	BI	10	10	\$96.00
876-CS30	3"	BI	10	10	\$114.00
876-CS35	3-1/2"	BI	10	10	\$170.00
876-CS40	4"	BI	10	10	\$185.00
876-CS60	6"	BI	10	10	\$660.00
876-CS80	8"	BI	10	10	\$1,334.00

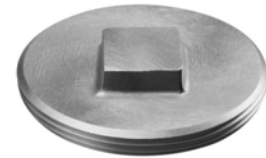

876-RS20



876-CS35



# Specification Fixture Carriers

**Water Closet Carriers**

**Lavatory Carriers**

**Urinal Carriers**

**Water-Cooler Carriers**

Floor-mounted Carriers and supports for commercial water closet and lavatory fixtures. Water closet carriers available for bariatric applications up to 1,000 lbs.

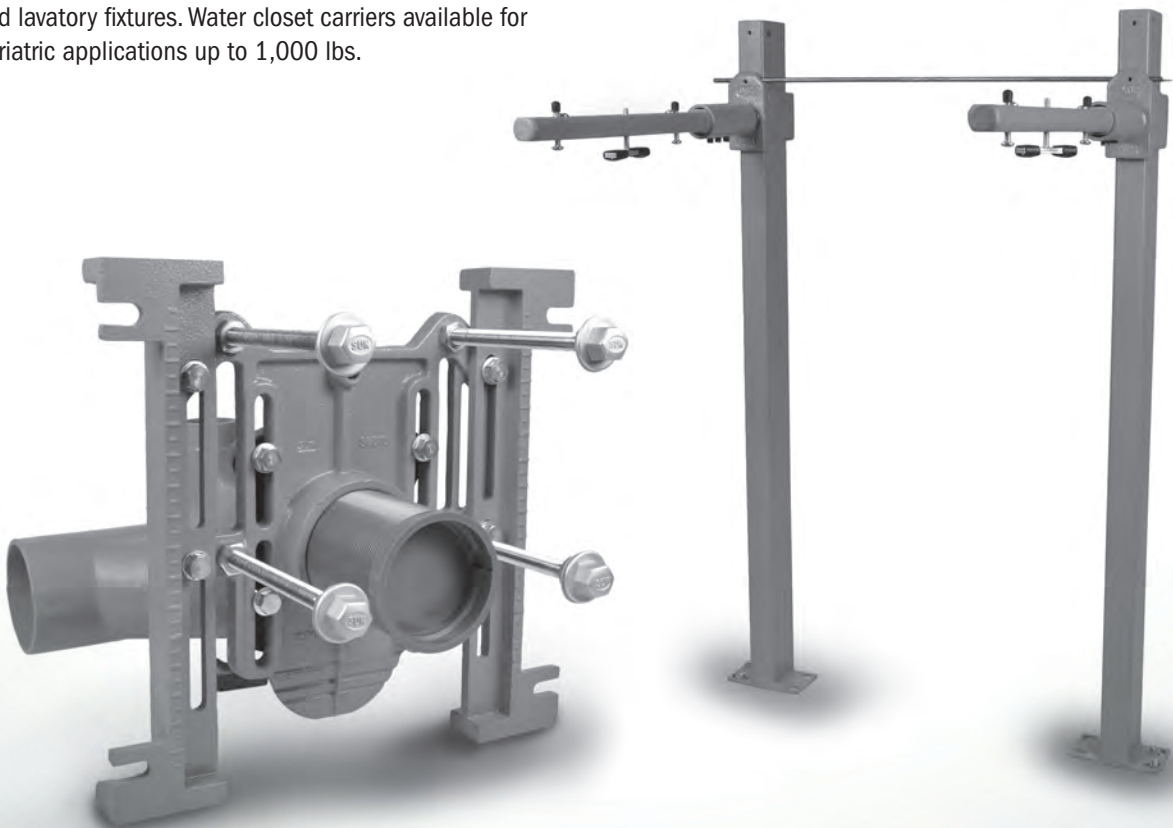

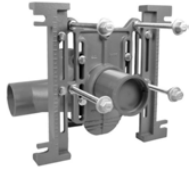

**837-HSR**  
Page 305



**837-HXR**  
Page 305

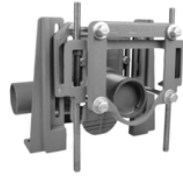

**837-HBR**  
Page 306



**837-VS10**  
Page 306



**837-VX10**  
Page 307





**837-VB10**  
Page 307



**837-7P**  
Page 309



**837-7D2**  
Page 311

 <b>837-VB10</b> Page 307	 <b>837-7P</b> Page 309	 <b>837-7D2</b> Page 311		



**Horizontal**

**Standard (500 Lb)**

**Options:** Add suffix to item no. Add price to list  
 T = 12" ABS Threaded Coupling (1): \$53.00;

1: In lieu of 6" coupling (standard)

**Related Products**

Carrier Bracket p 533

Item Number	Item Description	Pkg Type	Min Qty	Case Qty	Price
<b>STANDARD</b>					
837-HSD	4" No-Hub, Double	B	1	1	\$3,600.00
837-HSL	4" No-Hub, Left	B	1	1	\$2,000.00
837-HSR	4" No-Hub, Right	B	1	1	\$2,000.00
<b>WIDE CHASE</b>					
837-HSDW	4" No-Hub, Double	B	1	1	\$4,600.00
837-HSLW	4" No-Hub, Left	B	1	1	\$2,400.00
837-HSRW	4" No-Hub, Right	B	1	1	\$2,400.00



837-HSR



837-HSRW

**Horizontal**

**Extra-Heavy (750 Lb)**

**Options:** Add suffix to item no. Add price to list  
 T = 12" ABS Threaded Coupling (1): \$53.00;

1: In lieu of 6" coupling (standard)

Item Number	Item Description	Pkg Type	Min Qty	Case Qty	Price
837-HXD	4" No-Hub, Double	B	1	1	\$7,100.00
837-HXL	4" No-Hub, Left	B	1	1	\$4,000.00
837-HXR	4" No-Hub, Right	B	1	1	\$4,000.00



837-HXR

Supply

Drainage

Support

Specialties

Appendix

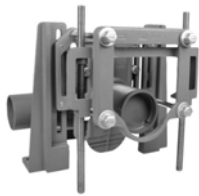

837-HBR

### Horizontal Bariatric (1,000 Lb)

**Options:** Add suffix to item no. Add price to list  
T = 12" ABS Threaded Coupling (1): \$53.00;

1: In lieu of 6" coupling (standard)

Item Number	Item Description	Pkg Type	Min Qty	Case Qty	Price
837-HBD	4" No-Hub, Double	B	1	1	\$9,550.00
837-HBL	4" No-Hub, Left	B	1	1	\$5,800.00
837-HBR	4" No-Hub, Right	B	1	1	\$5,800.00

### Vertical Standard (500 Lb)

**Options:** Add suffix to item no. Add price to list  
T = 12" ABS Threaded Coupling (1): \$53.00;

1: In lieu of 6" coupling (standard)



837-VS10



837-VS10W

Item Number	Item Description	Pkg Type	Min Qty	Case Qty	Price
<b>STANDARD</b>					
837-VS10	4" No-Hub, No-Side Inlet	B	1	1	\$2,200.00
837-VS12	4" No-Hub, 2 Side Inlets	B	1	1	\$2,200.00
837-VS1L	4" No-Hub, Left Side Inlet	B	1	1	\$2,200.00
837-VS1R	4" No-Hub, Right Side Inlet	B	1	1	\$2,200.00
837-VS20	4" No-Hub, No-Side Inlet, Double	B	1	1	\$3,900.00
837-VS21	4" No-Hub, 1 Side Inlet, Double	B	1	1	\$3,900.00
837-VS22	4" No-Hub, 2 Side Inlets Double	B	1	1	\$3,900.00
<b>WIDE CHASE</b>					
837-VS10W	4" No-Hub, No-Side Inlet	B	1	1	\$2,500.00
837-VS12W	4" No-Hub, Two Side Inlets	B	1	1	\$2,500.00
837-VS1LW	4" No-Hub, Left Side Inlet	B	1	1	\$2,500.00
837-VS1RW	4" No-Hub, Right Side Inlet	B	1	1	\$2,500.00
837-VS20W	4" No-Hub, No-Side Inlet, Double	B	1	1	\$4,500.00
837-VS21W	4" No-Hub, 1 Side Inlet, Double	B	1	1	\$4,500.00
837-VS22W	4" No-Hub, 2 Side Inlets Double	B	1	1	\$4,500.00

**Vertical**

**Extra-Heavy (750 Lb)**

**Options:** Add suffix to item no. Add price to list

T = 12" ABS Threaded Coupling (1): \$53.00;

1: In lieu of 6" coupling (standard)



837-VX10

Item Number	Item Description	Pkg Type	Min Qty	Case Qty	Price
<b>SINGLE</b>					
837-VX10	4" No-Hub, No-Side Inlet	B	1	1	\$4,600.00
837-VX12	4" No-Hub, 2 Side Inlets	B	1	1	\$4,600.00
837-VX1L	4" No-Hub, Left Side Inlet	B	1	1	\$4,600.00
837-VX1R	4" No-Hub, Right Side Inlet	B	1	1	\$4,600.00
<b>DOUBLE</b>					
837-VX20	4" No-Hub, No-Side Inlet, Double	B	1	1	\$9,000.00
837-VX21	4" No-Hub, 1 Side Inlet, Double	B	1	1	\$9,000.00
837-VX22	4" No-Hub, 2 Side Inlets Double	B	1	1	\$9,000.00

**Vertical**

**Bariatric (1,000 Lb)**

**Options:** Add suffix to item no. Add price to list

T = 12" ABS Threaded Coupling (1): \$53.00;

1: In lieu of 6" coupling (standard)



837-VB10

Item Number	Item Description	Pkg Type	Min Qty	Case Qty	Price
<b>SINGLE</b>					
837-VB10	4" No-Hub, No-Side Inlet	B	1	1	\$6,300.00
837-VB12	4" No-Hub, 2 Side Inlets	B	1	1	\$6,300.00
837-VB1L	4" No-Hub, Left Side Inlet	B	1	1	\$6,300.00
837-VB1R	4" No-Hub, Right Side Inlet	B	1	1	\$6,300.00
<b>DOUBLE</b>					
837-VB20	4" No-Hub, No-Side Inlet, Double	B	1	1	\$12,500.00
837-VB21	4" No-Hub, 1 Side Inlet, Double	B	1	1	\$12,500.00
837-VB22	4" No-Hub, 2 Side Inlets Double	B	1	1	\$12,500.00

**Closet Carrier Accessories**

Item Number	Item Description	Pkg Type	Min Qty	Case Qty	Price
<b>THREADED COUPLINGS</b>					
837-06	4" ABS Threaded WC Coupling - 6" Long	Bl	1	1	\$60.00
837-12	4" ABS Threaded WC Coupling - 12" Long	Bl	1	1	\$120.00

Supply

Drainage

Support

Specialties

Appendix

**Closet Carrier Accessories (Cont)**

Item Number	Item Description	Pkg Type	Min Qty	Case Qty	Price
<b>FACE PLATE ASSEMBLY KIT</b>					
837-FPA	WC Carrier Faceplate Assembly Kit - Standard	BI	1	1	\$1,350.00
837-FPAH	WC Carrier Faceplate Assembly Kit - Heavy-Duty	BI	1	1	\$1,435.00
<b>TILING FRAME</b>					
837-TF	Finish Tiling Frame for Closet Carrier - ABS	BI	1	20	\$120.00
<b>SUPPORT LEGS &amp; ANCHORS</b>					
837-LEG	Standard Leg Support (1) for WC Carrier Faceplate - Reversible	BI	1	1	\$205.00
837-LEGHL	Heavy-Duty Leg Support for WC Carrier Faceplate - Left	BI	1	1	\$235.00
837-LEGHR	Heavy-Duty Leg Support for WC Carrier Faceplate - Right	BI	1	1	\$235.00
837-RA	Rear Anchor Support Kit for WC Carrier - Standard	BI	1	35	\$160.00
<b>HARDWARE PACKS</b>					
837-FH	Finish Hardware Pack for WC Carrier	BI	1	30	\$160.00
837-RH	Rough-in Hardware Pack for WC Carrier	BI	1	35	\$160.00
837-TR	Thread Rod & Sleeve Pack for WC Carrier	BI	1	15	\$80.00



837-FPA



837-TF

Supply

Drainage

Support

Specialties

Appendix

### Concealed Arm

- Used to support wall-hung fixtures where the load-bearing carrier is concealed within the wall
- Includes coated steel uprights with welded feet, cast iron adjustable header couplings, steel sleeves, concealed arms, truss rod, and mounting hardware

**Options:** Add suffix to item no. Add price to list  
**B** = Back-to-Back Carrier: \$500.00;



837-7C

Item Number	Item Description	Pkg Type	Min Qty	Case Qty	Price
837-7C15	Lavatory Carrier, 15" Concealed Arm	B	1	1	\$1,230.00
837-7C18	Lavatory Carrier, 18" Concealed Arm	B	1	1	\$1,230.00
837-7C22	Lavatory Carrier, 22" Concealed Arm	B	1	1	\$1,230.00

### Adjustable Concealed Arm

- Used to support wall-hung fixtures where the load-bearing carrier is concealed within the wall
- Includes coated steel uprights with welded feet, cast iron adjustable header couplings, steel sleeves, concealed arms, and mounting hardware

**Options:** Add suffix to item no. Add price to list  
**B** = Back-to-Back Carrier: \$500.00;



Item Number	Item Description	Pkg Type	Min Qty	Case Qty	Price
837-7CA15	Lavatory Carrier, 15" Adjustable Concealed Arm	B	1	1	\$1,538.00
837-7CA18	Lavatory Carrier, 18" Adjustable Concealed Arm	B	1	1	\$1,538.00
837-7CA22	Lavatory Carrier, 22" Adjustable Concealed Arm	B	1	1	\$1,538.00

### Plate Type

- Used to support wall-hung fixtures where the load-bearing carrier is concealed within the wall
- Includes coated steel uprights with welded feet, coated steel bearing plate(s) and mounting hardware

**Options:** Add suffix to item no. Add price to list  
**B** = Back-to-Back Carrier: \$500.00;



837-7P



837-7W

Item Number	Item Description	Pkg Type	Min Qty	Case Qty	Price
<b>CARRIER</b>					
837-7P	Fixture Carrier, Single-Plate Type For Lavatory / Urinal / Water Cooler	B	1	1	\$925.00
<b>WALL PLATE</b>					
837-7W	Fixture Carrier, Wall Plate for Lavatory / Urinal / Water Cooler	B	1	1	\$275.00

Supply

Drainage

Support

Specialties

Appendix

Supply

Drainage

Support

Specialties

Appendix



837-7D



837-7P

### Plate Type

- Used to support wall-hung fixtures where the load-bearing carrier is concealed within the wall
- Includes coated steel uprights with welded feet, coated steel bearing plate(s) and mounting hardware

Item Number	Item Description	Pkg Type	Min Qty	Case Qty	Price
<b>CARRIER</b>					
837-7D	Fixture Carrier, Dual-Plate Type For Urinal or Water Cooler	B	1	1	\$1,025.00
837-7P	Fixture Carrier, Single-Plate Type For Lavatory / Urinal / Water Cooler	B	1	1	\$925.00
<b>WALL PLATE</b>					
837-7W	Fixture Carrier, Wall Plate for Lavatory / Urinal / Water Cooler	B	1	1	\$275.00

**Plate Type**

- Used to support wall-hung fixtures where the load-bearing carrier is concealed within the wall
- Includes coated steel uprights with welded feet, coated steel bearing plate(s) and mounting hardware

Item Number	Item Description	Pkg Type	Min Qty	Case Qty	Price
<b>SINGLE</b>					
837-7D	Fixture Carrier, Dual-Plate Type For Urinal or Water Cooler	B	1	1	\$1,025.00
837-7P	Fixture Carrier, Single-Plate Type For Lavatory / Urinal / Water Cooler	B	1	1	\$925.00
<b>SIDE-BY-SIDE</b>					
837-7D2	Water Cooler Carrier, Side-by-Side, Dual-Plate Type	B	1	1	\$1,400.00
837-7P2	Water Cooler Carrier, Side-by-Side, Single-Plate Type	B	1	1	\$1,230.00
<b>WALL PLATE</b>					
837-7W	Fixture Carrier, Wall Plate for Lavatory / Urinal / Water Cooler	B	1	1	\$275.00



837-7D



837-7P



837-7D2



837-7P2

Supply

Drainage

Support

Specialties

Appendix





# **Commercial Drainage**

**Floor Drains**

**Floor Sinks**

**Roof Drains**

**Cleanouts**

# Commercial Drainage

## Floor Drains

Adjustable and non-adjustable floor drains for on-grade and above-grade applications. Cast iron, PVC and ABS connections available. Designed in accordance with ASME A112.6.3 Standard for Floor and Trench Drains.

**Note:** All floor drains installed in above-grade applications must be leak tested for watertightness according to local codes and standards. Failure to do so will void the warranty.

## Floor Sinks

PVC floor sinks designed for direct or indirect waste applications.

Designed in accordance with ASME A112.6.7 Standard for Sanitary Floor Sinks.

**Note:** All floor sinks installed in above-grade applications must be leak tested for watertightness according to local codes and standards. Failure to do so will void the warranty.

## Roof Drains

Roof drain, overflow, scupper and accessory fixtures available with PVC and ABS connections.

Designed in accordance with ASME A112.6.4 Standard for Roof, Deck, and Balcony Drains.

**Note:** All roof drains must be leak tested for watertightness according to local codes and standards. Failure to do so will void the warranty.

## Cleanouts

Adjustable and non-adjustable cleanout fixtures provide access to drain lines. PVC and ABS connections available. Designed in accordance with ASME A112.36.2M Standard for Cleanouts.

**Note:** All roof drains must be leak tested for watertightness according to local codes and standards. Failure to do so will void the warranty.

# Commercial Floor Drains

**FinishLine™ On-Grade Floor Drains**

**FatMax™ Floor Drains**

**FinishLine™ Above-Grade Floor Drains**

**Halo™ Floor Drains**

**Floor Drain Accessories**



Sioux Chief's FinishLine™ Floor drain system is adjustable both before and AFTER the concrete pour.

The FinishLine virtually eliminates drains set too low or not level. Installations that are faster, easier, and more professional looking.



**832-2PNQ**  
Page 317



**832-35ASR**  
Page 319



**842-36PI**  
Page 320



**842-36LP**  
Page 321



**843-2PNR**  
Page 322



**860-2AZ**  
Page 323



**864-2P**  
Page 324



**833-2PSR**  
Page 325



**833-35ANR**  
Page 327



**833-22NR**  
Page 328



**833-235SR**  
Page 329



**833-62NR**  
Page 331



**833-625NQ**  
Page 332



**863-42NQ**  
Page 333



**863-325NR**  
Page 334



**863-24NQ**  
Page 335



**863-64NQ**  
Page 336



**822-2PSQ**  
Page 337



**822-F2ANR**  
Page 338

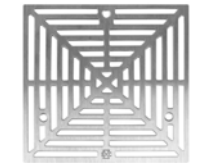

**842-SNQ3**  
Page 340



**842-SP2**  
Page 340



**842-82PT**  
Page 341



**863-HP23**  
Page 341



**850-VW1**  
Page 342

**PVC/ABS - Sch. 40 Hub Connection**

**6-1/2" Tops**

**Options:** Add suffix to item no. Add price to list

**V** = Vandal-Resistant Strainer: \$6.50; **H** = Hinged Strainer: \$16.00;

**E** = Extended Ring (1): \$78.00; **B** = Complies with Buy American Act (1): \$62.00;

1: For round nickel bronze ring/strainer only



832-36AF



832-4HSR

Item Number	Item Description	Pkg Type	Min Qty	Case Qty	Price
<b>ROUGH-IN FIXTURE</b>					
832-2AF	2" ABS Hub	Bl	1	10	\$23.95
832-2PF	2" PVC Hub	Bl	1	10	\$23.95
832-36AF	3" ABS Hub	Bl	1	10	\$23.95
832-36PF	3" PVC Hub	Bl	1	10	\$23.95
832-4AF	4" ABS Hub	Bl	1	10	\$23.95
832-4PF	4" PVC Hub	Bl	1	10	\$23.95
<b>FINISH FIXTURE</b>					
832-4HNQ	7" Sqr Nikl-Brnz Ring & Strainer	Bl	1	10	\$96.41
832-4HNR	6-1/2" Rnd Nikl-Brnz Ring & Strainer	Bl	1	10	\$64.92
832-4HSQ	7" Sqr Stnls Steel Ring & Strainer	Bl	1	1	\$96.41
832-4HSR	6-1/2" Rnd Stnls Steel Ring & Strainer	Bl	1	10	\$64.92
<b>COMPLETE ASSEMBLY</b>					
832-2ANQ	2" ABS Hub - 7" Sqr Nikl-Brnz Ring & Strainer	Bl	1	1	\$120.37
832-2ANR	2" ABS Hub - 6-1/2" Rnd Nikl-Brnz Ring & Strainer	Bl	1	1	\$88.86
<b>832-2ASQ</b>	2" ABS Hub - 7" Sqr Stnls Steel Ring & Strainer	Bl	1	1	\$120.37
<b>832-2ASR</b>	2" ABS Hub - 6-1/2" Rnd Stnls Steel Ring & Strainer	Bl	1	1	\$93.36
832-2PNQ	2" PVC Hub - 7" Sqr Nikl-Brnz Ring & Strainer	Bl	1	1	\$120.37
832-2PNR	2" PVC Hub - 6-1/2" Rnd Nikl-Brnz Ring & Strainer	Bl	1	1	\$88.86
832-2PSQ	2" PVC Hub - 7" Sqr Stnls Steel Ring & Strainer	Bl	1	1	\$120.37
<b>832-2PSR</b>	2" PVC Hub - 6-1/2" Rnd Stnls Steel Ring & Strainer	Bl	1	1	\$93.36
<b>832-36ANQ</b>	3" ABS Hub - 7" Sqr Nikl-Brnz Ring & Strainer	Bl	1	1	\$120.37
832-36ANR	3" ABS Hub - 6-1/2" Rnd Nikl-Brnz Ring & Strainer	Bl	1	1	\$88.86
<b>832-36ASQ</b>	3" ABS Hub - 7" Sqr Stnls Steel Ring & Strainer	Bl	1	1	\$120.37
<b>832-36ASR</b>	3" ABS Hub - 6-1/2" Rnd Stnls Steel Ring & Strainer	Bl	1	1	\$93.36
832-36PNQ	3" PVC Hub - 7" Sqr Nikl-Brnz Ring & Strainer	Bl	1	1	\$120.37
832-36PNR	3" PVC Hub - 6-1/2" Rnd Nikl-Brnz Ring & Strainer	Bl	1	1	\$88.86
<b>832-36PSQ</b>	3" PVC Hub - 7" Sqr Stnls Steel Ring & Strainer	Bl	1	1	\$120.37
832-36PSR	3" PVC Hub - 6-1/2" Rnd Stnls Steel Ring & Strainer	Bl	1	1	\$93.36
<b>832-4ANQ</b>	4" ABS Hub - 7" Sqr Nikl-Brnz Ring & Strainer	Bl	1	1	\$120.37
832-4ANR	4" ABS Hub - 6-1/2" Rnd Nikl-Brnz Ring & Strainer	Bl	1	1	\$88.86
<b>832-4ASQ</b>	4" ABS Hub - 7" Sqr Stnls Steel Ring & Strainer	Bl	1	1	\$120.37
<b>832-4ASR</b>	4" ABS Hub - 6-1/2" Rnd Stnls Steel Ring & Strainer	Bl	1	1	\$88.86
832-4PNQ	4" PVC Hub - 7" Sqr Nikl-Brnz Ring & Strainer	Bl	1	1	\$120.37
832-4PNR	4" PVC Hub - 6-1/2" Rnd Nikl-Brnz Ring & Strainer	Bl	1	1	\$88.86
<b>832-4PSQ</b>	4" PVC Hub - 7" Sqr Stnls Steel Ring & Strainer	Bl	1	1	\$120.37

Supply

Drainage

Support

Specialties

Appendix

Supply

Drainage

Support

Specialties

Appendix



832-2PNQ

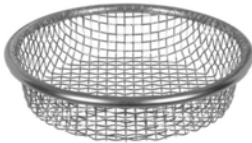

832-UM

**PVC/ABS - Sch. 40 Hub Connection (Cont)**

**6-1/2" Tops**

Item Number	Item Description	Pkg Type	Min Qty	Case Qty	Price
<b>COMPLETE ASSEMBLY</b>					
832-4PSR	4" PVC Hub - 6-1/2" Rnd Stnls Steel Ring & Strainer	BI	1	1	\$93.36
<b>ACCESSORIES</b>					
832-4HHD	Hub Drain Finish Fixture for 6-1/2" Top	BI	1	10	\$18.91
832-4HPR	Finish Fixture with 6-1/2" Rnd ABS Ring & Strainer	BI	1	10	\$34.63
832-EX4	Ductile Iron Extension Adapter - 2" Min - 4" Max	BI	1	1	\$34.14
832-P	Coring Plug Wrench	BI	1	1	\$24.65
832-S4	Two Adjustment Shims, Two 3/4" Screws	BI	1	10	\$6.10
832-UM	4-1/4" Stainless Steel Debris Basket	BI	1	15	\$21.43
832-W	Flexible Red Locating Bristles w/ Screw	BI	1	10	\$7.26
835-2	Trapshield™ For 2" Drain Outlet	BI	1	50	\$56.31
835-3	Trapshield™ For 3" Drain Outlet	BI	1	25	\$63.36
835-4	Trapshield™ For 4" Drain Outlet	BI	1	20	\$74.98
863-FA	Round Aluminum Condensate Funnel w/ Screws	BI	1	12	\$49.15
863-FN	Round Nikl-Brnz Condensate Funnel w/ Screws	BI	1	12	\$109.99
863-FNO	Oval Nikl-Brnz Condensate Funnel w/ Screws	BI	1	12	\$243.96

**PVC/ABS - Sch. 40 Hub Connection**

**5-1/2" Tops**

**Options:** Add suffix to item no. Add price to list

V = Vandal-Resistant Strainer: \$6.50; B = Complies with Buy American Act (1): \$62.00;

E = Extended Ring (1): \$78.00;

1: For round nickel bronze ring/strainer only



832-25PF



832-3HNQ



832-35ASR

Item Number	Item Description	Pkg Type	Min Qty	Case Qty	Price
<b>ROUGH-IN FIXTURE</b>					
832-25AF	2" ABS Hub	BI	1	10	\$19.55
832-25PF	2" PVC Hub	BI	1	10	\$19.55
832-35AF	3" ABS Hub	BI	1	10	\$19.55
832-35PF	3" PVC Hub	BI	1	10	\$19.55
<b>FINISH FIXTURE</b>					
832-3HNQ	5-7/8" Sqr Nikl-Brnz Ring & Strainer	BI	1	10	\$65.56
832-3HNR	5-1/2" Rnd Nikl-Brnz Ring & Strainer	BI	1	10	\$46.64
<b>832-3HSQ</b>	5-7/8" Sqr Stnls Steel Ring & Strainer	BI	1	10	\$65.56
832-3HSR	5-1/2" Rnd Stnls Steel Ring & Strainer	BI	1	10	\$46.64

**PVC/ABS - Sch. 40 Hub Connection (Cont)**

**5-1/2" Tops**



832-EPS3

Item Number	Item Description	Pkg Type	Min Qty	Case Qty	Price
<b>COMPLETE ASSEMBLY</b>					
832-25ANQ	2" ABS Hub - 5-7/8" Sqr Nikl-Brnz Ring & Strainer	Bl	1	1	\$85.06
832-25ANR	2" ABS Hub - 5-1/2" Rnd Nikl-Brnz Ring & Strainer	Bl	1	1	\$66.17
832-25ASQ	2" ABS Hub - 5-7/8" Sqr Stnls Steel Ring & Strainer	Bl	1	1	\$85.06
832-25ASR	2" ABS Hub - 5-1/2" Rnd Stnls Steel Ring & Strainer	Bl	1	1	\$66.17
832-25PNQ	2" PVC Hub - 5-7/8" Sqr Nikl-Brnz Ring & Strainer	Bl	1	1	\$85.06
832-25PNR	2" PVC Hub - 5-1/2" Rnd Nikl-Brnz Ring & Strainer	Bl	1	1	\$66.17
832-25PSQ	2" PVC Hub - 5-7/8" Sqr Stnls Steel Ring & Strainer	Bl	1	1	\$85.06
832-25PSR	2" PVC Hub - 5-1/2" Rnd Stnls Steel Ring & Strainer	Bl	1	1	\$66.17
832-35ANQ	3" ABS Hub - 5-7/8" Sqr Nikl-Brnz Ring & Strainer	Bl	1	1	\$85.06
832-35ANR	3" ABS Hub - 5-1/2" Rnd Nikl-Brnz Ring & Strainer	Bl	1	1	\$66.17
832-35ASQ	3" ABS Hub - 5-7/8" Sqr Stnls Steel Ring & Strainer	Bl	1	1	\$85.06
832-35ASR	3" ABS Hub - 5-1/2" Rnd Stnls Steel Ring & Strainer	Bl	1	1	\$66.17
832-35PNQ	3" PVC Hub - 5-7/8" Sqr Nikl-Brnz Ring & Strainer	Bl	1	1	\$85.06
832-35PNR	3" PVC Hub - 5-1/2" Rnd Nikl-Brnz Ring & Strainer	Bl	1	1	\$66.17
832-35PSQ	3" PVC Hub - 5-7/8" Sqr Stnls Steel Ring & Strainer	Bl	1	1	\$85.06
832-35PSR	3" PVC Hub - 5-1/2" Rnd Stnls Steel Ring & Strainer	Bl	1	1	\$66.17
<b>ACCESSORIES</b>					
822-EX3	Ductile Iron Extension Adapter	B	1	1	\$35.33
832-3HHD	Hub Drain Finish Fixture for 5-1/2" Top	Bl	1	10	\$15.64
832-3HS	Finish Fixture with Rnd 5-1/2" 18-Ga Stnls Steel Strainer	B	1	20	\$19.80
832-EPS3	Extended ABS Coring Sleeve & Plug	Bl	1	1	\$15.82
832-EX3	Ductile Iron Extension Adapter - 2" Min - 3-3/8" Max	Bl	1	1	\$34.14
832-P	Coring Plug Wrench	Bl	1	1	\$24.65
832-S3	Two Adjustment Shims, Two 3/4" Screws	Bl	1	10	\$6.10
832-W	Flexible Red Locating Bristles w/ Screw	Bl	1	10	\$7.26
835-2	Trapshield™ For 2" Drain Outlet	Bl	1	50	\$56.31
835-3	Trapshield™ For 3" Drain Outlet	Bl	1	25	\$63.36
863-FA	Round Aluminum Condensate Funnel w/ Screws	Bl	1	12	\$49.15
863-FN	Round Nikl-Brnz Condensate Funnel w/ Screws	Bl	1	12	\$109.99
863-FNO	Oval Nikl-Brnz Condensate Funnel w/ Screws	Bl	1	12	\$243.96

Supply

Drainage

Support

Specialties

Appendix

Adjustable Floor Drain

PVC/ABS - Sch. 40 Hub Connection

Options: Add suffix to item no. Add price to list

V = Vandal-Resistant Strainer: \$6.50; H = Hinged Strainer (1): \$16.00;

E = Extended Ring (2): \$78.00; B = Complies with Buy American Act (2): \$65.00;

Y = Ductile Iron Head Adapter (3): \$26.00; M = Medium-Duty Strainer (3,000 lbs. safe-load) (4): \$39.00;

1: For 6-1/2" and 7" nickel-bronze or SS304 ring/strainer only 2: For round nickel bronze ring/strainer only 3: In lieu of ABS (standard) 4: For 6-1/2" round SS 304 ring/strainer only



842-2ANR



842-36PSQ



842-36PI

Item Number	Item Description	Pkg Type	Min Qty	Case Qty	Price
<b>NICKEL-BRONZE RING &amp; STRAINER</b>					
842-2ANQ	2" ABS Hub - 5-7/8" Sqr Ring & Strainer	BI	1	1	\$90.48
842-2ANR	2" ABS Hub - 5-1/2" Rnd Ring & Strainer	BI	1	10	\$68.76
842-2PNQ	2" PVC Hub - 5-7/8" Sqr Ring & Strainer	BI	1	10	\$90.48
842-2PNR	2" PVC Hub - 5-1/2" Rnd Ring & Strainer	BI	1	10	\$68.76
842-36ANQ	3" ABS Hub - 7" Sqr Ring & Strainer	BI	1	1	\$119.43
842-36ANR	3" PVC Hub - 6-1/2" Rnd Ring & Strainer	BI	1	1	\$83.25
842-36PNQ	3" PVC Hub - 7" Sqr Ring & Strainer	BI	1	10	\$119.43
842-36PNR	3" PVC Hub - 6-1/2" Rnd Ring & Strainer	BI	1	10	\$83.25
842-3ANQ	3" ABS Hub - 5-7/8" Sqr Ring & Strainer	BI	1	1	\$90.48
842-3ANR	3" PVC Hub - 5-1/2" Rnd Ring & Strainer	BI	1	8	\$68.76
842-3PNQ	3" PVC Hub - 5-7/8" Sqr Ring & Strainer	BI	1	10	\$90.48
842-3PNR	3" PVC Hub - 5-1/2" Rnd Ring & Strainer	BI	1	8	\$68.76
842-4ANQ	4" ABS Hub - 7" Sqr Ring & Strainer	BI	1	1	\$119.43
842-4ANR	4" ABS Hub - 6-1/2" Rnd Ring & Strainer	BI	1	10	\$83.25
842-4PNQ	4" PVC Hub - 7" Sqr Ring & Strainer	BI	1	10	\$119.43
842-4PNR	4" PVC Hub - 6-1/2" Rnd Ring & Strainer	BI	1	10	\$83.25
<b>STAINLESS STEEL RING &amp; STRAINER</b>					
842-2ASQ	2" ABS Hub - 5-7/8" Sqr Ring & Strainer	BI	1	1	\$90.48
842-2ASR	2" ABS Hub - 5-1/2" Rnd Ring & Strainer	BI	1	1	\$68.76
842-2PSQ	2" PVC Hub - 5-7/8" Sqr Ring & Strainer	BI	1	10	\$90.48
842-2PSR	2" PVC Hub - 5-1/2" Rnd Ring & Strainer	BI	1	10	\$68.76
842-36ASQ	3" ABS Hub - 7" Sqr Ring & Strainer	BI	1	1	\$119.43
842-36ASR	3" PVC Hub - 6-1/2" Rnd Ring & Strainer	BI	1	1	\$83.25
842-36PSQ	3" PVC Hub - 7" Sqr Ring & Strainer	BI	1	1	\$119.43
842-36PSR	3" PVC Hub - 6-1/2" Rnd Ring & Strainer	BI	1	10	\$83.25
842-3ASQ	3" ABS Hub - 5-7/8" Sqr Ring & Strainer	BI	1	1	\$90.48
842-3ASR	3" PVC Hub - 5-1/2" Rnd Ring & Strainer	BI	1	1	\$68.76
842-3PSQ	3" PVC Hub - 5-7/8" Sqr Ring & Strainer	BI	1	10	\$90.48
842-3PSR	3" PVC Hub - 5-1/2" Rnd Ring & Strainer	BI	1	8	\$68.76
842-4ASQ	4" ABS Hub - 7" Sqr Ring & Strainer	BI	1	1	\$119.43
842-4ASR	4" ABS Hub - 6-1/2" Rnd Ring & Strainer	BI	1	1	\$83.25
842-4PSQ	4" PVC Hub - 7" Sqr Ring & Strainer	BI	1	1	\$119.43
842-4PSR	4" PVC Hub - 6-1/2" Rnd Ring & Strainer	BI	1	10	\$83.25
<b>CAST IRON RING &amp; STRAINER</b>					
842-36PI	3" PVC Hub - 6-5/8" Rnd Ring & Strainer	BI	1	2	\$67.74
842-4PI	4" PVC Hub - 6-5/8" Rnd Ring & Strainer	BI	1	2	\$67.74

Supply

Drainage

Support

Specialties

Appendix



**Adjustable Floor Drain (Cont)**

**PVC/ABS - Sch. 40 Hub Connection**

Item Number	Item Description	Pkg Type	Min Qty	Case Qty	Price
<b>ACCESSORIES</b>					
835-2	Trapshield™ For 2" Drain Outlet	Bl	1	50	\$56.31
835-3	Trapshield™ For 3" Drain Outlet	Bl	1	25	\$63.36
835-35	Trapshield™ For 3-1/2" Drain Head	Bl	1	25	\$63.36
835-4	Trapshield™ For 4" Drain Outlet	Bl	1	20	\$74.98
842-UM	4-5/8" Stainless Steel Debris Basket	Bl	1	1	\$21.67
863-FA	Round Aluminum Condensate Funnel w/ Screws	Bl	1	12	\$49.15
863-FN	Round Nikl-Brnz Condensate Funnel w/ Screws	Bl	1	12	\$109.99
863-FNO	Oval Nikl-Brnz Condensate Funnel w/ Screws	Bl	1	12	\$243.96



863-FA

**Adjustable Floor Drain Head**

**ABS - MIP Thread Connection**

**Options:** Add suffix to item no. Add price to list

**V** = Vandal-Resistant Strainer: \$6.50; **H** = Hinged Strainer (1): \$16.00;

**E** = Extended Ring (2): \$78.00; **M** = Medium-Duty Strainer (3,000 lbs. safe-load) (3): \$39.00;

1: For 6-1/2" and 7" nickel-bronze or SS304 ring/strainer only 2: For 5-1/2" and 6-1/2" round nickel bronze ring/strainer only 3: For 6-1/2" round SS 304 ring/strainer only

Item Number	Item Description	Pkg Type	Min Qty	Case Qty	Price
<b>NICKEL-BRONZE RING &amp; STRAINER</b>					
842-2LNQ	2" MIP - 4-1/2" Sqr Ring & Strainer	Bl	1	5	\$65.15
842-2LNR	2" MIP - 4-1/2" Rnd Ring & Strainer	Bl	1	10	\$50.67
842-36LNQ	3" MIP - 7" Sqr Ring & Strainer	Bl	1	5	\$108.57
842-36LNR	3" MIP - 6-1/2" Rnd Ring & Strainer	Bl	1	10	\$72.38
842-3LNQ	3" MIP - 5-7/8" Sqr Ring & Strainer	Bl	1	5	\$90.48
842-3LNR	3" MIP - 5-1/2" Rnd Ring & Strainer	Bl	1	10	\$68.76
842-3LNRPK	3" MIP - 5-1/2" Rnd Ring & Strainer	Cl	5	5	\$69.76
<b>842-4LNQ</b>	4" MIP - 7" Sqr Ring & Strainer	Bl	1	5	\$119.43
842-4LNR	4" MIP - 6-1/2" Rnd Ring & Strainer	Bl	1	10	\$83.25
<b>STAINLESS STEEL RING &amp; STRAINER</b>					
<b>842-2LSQ</b>	2" MIP - 4-1/2" Sqr Ring & Strainer	Bl	1	1	\$65.15
842-2LSR	2" MIP - 4-1/2" Rnd Ring & Strainer	Bl	1	1	\$50.67
<b>842-36LSQ</b>	3" MIP - 7" Sqr Ring & Strainer	Bl	1	1	\$108.57
842-36LSR	3" MIP - 6-1/2" Rnd Ring & Strainer	Bl	1	10	\$72.38
842-3LSQ	3" MIP - 5-7/8" Sqr Ring & Strainer	Bl	1	5	\$90.48
842-3LSR	3" MIP - 5-1/2" Rnd Ring & Strainer	Bl	1	10	\$68.76
<b>842-4LSQ</b>	4" MIP - 7" Sqr Ring & Strainer	Bl	1	1	\$119.43
842-4LSR	4" MIP - 6-1/2" Rnd Ring & Strainer	Bl	1	10	\$83.25
<b>GRAY ABS STRAINER</b>					
842-2LP	2" MIP - 4-3/8" Rnd Ring & Strainer	Bl	1	10	\$28.96
<b>842-36LP</b>	3" MIP - 6-1/2" Rnd Ring & Strainer	Bl	1	1	\$36.19
842-3LP	3" MIP - 5-1/2" Rnd Ring & Strainer	Bl	1	10	\$39.81
842-4LP	4" MIP - 6-1/2" Rnd Ring & Strainer	Bl	1	10	\$47.05



842-2LNQ



842-36LP

Supply

Drainage

Support

Specialties

Appendix



863-FNO

### Adjustable Floor Drain Head (Cont)

#### ABS - MIP Thread Connection

Item Number	Item Description	Pkg Type	Min Qty	Case Qty	Price
<b>ACCESSORIES</b>					
832-UM	4-1/4" Stainless Steel Debris Basket	BI	1	15	\$21.43
863-FA	Round Aluminum Condensate Funnel w/ Screws	BI	1	12	\$49.15
863-FN	Round Nikl-Brnz Condensate Funnel w/ Screws	BI	1	12	\$109.99
863-FNO	Oval Nikl-Brnz Condensate Funnel w/ Screws	BI	1	12	\$243.96

### Non-Adjustable Floor Drain

#### PVC/ABS - Sch. 40 Hub Connection

**Options:** Add suffix to item no. Add price to list  
 V = Vandal-Resistant Strainer: \$6.50;



843-2PNR



843-2PS



843-2PP

Item Number	Item Description	Pkg Type	Min Qty	Case Qty	Price
<b>NICKEL-BRONZE RING &amp; STRAINER</b>					
<b>843-2ANQ</b>	2" ABS Hub - 4-1/2" Sqr Ring & Strainer	BI	1	1	\$68.76
843-2ANR	2" ABS Hub - 4-1/2" Rnd Ring & Strainer	BI	1	10	\$54.29
843-2PNQ	2" PVC Hub - 4-1/2" Sqr Ring & Strainer	BI	1	5	\$68.76
843-2PNR	2" PVC Hub - 4-1/2" Rnd Ring & Strainer	BI	1	10	\$54.29
843-3ANQ	3" ABS Hub - 5-7/8" Sqr Ring & Strainer	BI	1	10	\$85.04
<b>843-3ANR</b>	3" ABS Hub - 5-1/2" Rnd Ring & Strainer	BI	1	1	\$63.33
843-3PNQ	3" PVC Hub - 5-7/8" Sqr Ring & Strainer	BI	1	10	\$85.04
843-3PNR	3" PVC Hub - 5-1/2" Rnd Ring & Strainer	BI	1	10	\$63.33
<b>843-4ANQ</b>	4" ABS Hub - 7" Sqr Ring & Strainer	BI	1	1	\$114.37
<b>843-4ANR</b>	4" ABS Hub - 6-1/2" Rnd Ring & Strainer	BI	1	4	\$78.17
843-4PNQ	4" PVC Hub - 7" Sqr Ring & Strainer	BI	1	10	\$114.37
843-4PNR	4" PVC Hub - 6-1/2" Rnd Ring & Strainer	BI	1	4	\$78.17
<b>18-GA STAINLESS STEEL STRAINER</b>					
843-2AS	2" ABS Hub - 4-1/2" Rnd Ring & Strainer	BI	1	10	\$26.21
843-2PS	2" PVC Hub - 4-1/2" Rnd Ring & Strainer	BI	1	10	\$26.21
<b>843-3AS</b>	3" ABS Hub - 5-1/2" Rnd Ring & Strainer	BI	1	1	\$28.06
843-3PS	3" PVC Hub - 5-1/2" Rnd Ring & Strainer	BI	1	10	\$28.06
<b>843-4AS</b>	4" ABS Hub - 6-1/2" Rnd Ring & Strainer	BI	1	1	\$35.94
843-4PS	4" PVC Hub - 6-1/2" Rnd Ring & Strainer	BI	1	4	\$35.94
<b>ABS STRAINER</b>					
<b>843-2AP</b>	2" ABS Hub - 4-1/2" Rnd Ring & Strainer	BI	1	1	\$25.34
843-2PP	2" PVC Hub - 4-1/2" Rnd Ring & Strainer	BI	1	1	\$25.34
843-3AP	3" ABS Hub - 5-1/2" Rnd Ring & Strainer	BI	1	10	\$27.13
843-3PP	3" PVC Hub - 5-1/2" Rnd Ring & Strainer	BI	1	10	\$27.13
<b>843-4PP</b>	4" PVC Hub - 6-1/2" Rnd Ring & Strainer	BI	1	1	\$41.98

**PVC/ABS - Sch. 40 Hub Connection**

**Options:** Add suffix to item no. Add price to list

- S** = ABS Sand Bucket: \$14.00; **U** = ABS Debris Bucket: \$14.00;
- C** = ABS Clamping Collar: \$17.00; **V** = Vandal-Resistant Strainer (1): \$12.00;
- T** = Tapped Trap Primer Connection - 1/2" FIP: \$12.00; **2** = Open-Half Strainer (1): N/C;
- W** = Stainless Steel Debris Basket: \$52.00; **F** = Round Nickel-Bronze Condensate Funnel: \$108.00;
- FA** = Round Aluminum Condensate Funnel: \$48.00; **FO** = Oval Nickel-Bronze Condensate Funnel: \$238.00;
- 6** = ABS Flat Strainer for Drain Outlet (2): \$12.00; **D** = ABS Dome Bottom Strainer (2): \$10.00;
- L** = Aluminum Dome Bottom Strainer (2): \$22.00;

1: Not available for cast iron strainers 2: Not available for 6" drains

Item Number	Item Description	Pkg Type	Min Qty	Case Qty	Price
<b>NICKEL-BRONZE RING &amp; STRAINER</b>					
860-2AN	2" ABS Hub - 9-3/4" Rnd Grate	Bl	1	1	\$343.80
860-2PN	2" PVC Hub - 9-3/4" Rnd Grate	Bl	1	1	\$343.80
860-3AN	3" ABS Hub - 9-3/4" Rnd Grate	Bl	1	1	\$343.80
860-3PN	3" PVC Hub - 9-3/4" Rnd Grate	Bl	1	4	\$343.80
860-4AN	4" ABS Hub - 9-3/4" Rnd Grate	Bl	1	1	\$343.80
860-4PN	4" PVC Hub - 9-3/4" Rnd Grate	Bl	1	4	\$343.80
860-6AN	6" ABS Hub - 9-3/4" Rnd Grate	Bl	1	1	\$463.24
860-6PN	6" PVC Hub - 9-3/4" Rnd Grate	Bl	1	1	\$463.24
<b>STAINLESS STEEL RING &amp; STRAINER</b>					
860-2AZ	2" ABS Hub - 9-3/4" Rnd Grate	Bl	1	1	\$343.80
860-2PZ	2" PVC Hub - 9-3/4" Rnd Grate	Bl	1	4	\$343.80
860-3AZ	3" ABS Hub - 9-3/4" Rnd Grate	Bl	1	1	\$343.80
860-3PZ	3" PVC Hub - 9-3/4" Rnd Grate	Bl	1	4	\$343.80
860-4AZ	4" ABS Hub - 9-3/4" Rnd Grate	Bl	1	4	\$343.80
860-4PZ	4" PVC Hub - 9-3/4" Rnd Grate	Bl	1	4	\$343.80
860-6AZ	6" ABS Hub - 9-3/4" Rnd Grate	Bl	1	1	\$463.24
860-6PZ	6" PVC Hub - 9-3/4" Rnd Grate	Bl	1	1	\$463.24
<b>ABS/PVC STRAINER</b>					
860-2A	2" ABS Hub - 9" Rnd Grate	Bl	1	1	\$83.25
860-2P	2" PVC Hub - 9" Rnd Grate	Bl	1	4	\$83.25
860-3A	3" ABS Hub - 9" Rnd Grate	Bl	1	4	\$83.25
860-3P	3" PVC Hub - 9" Rnd Grate	Bl	1	4	\$83.25
860-4A	4" ABS Hub - 9" Rnd Grate	Bl	1	1	\$83.25
860-4P	4" PVC Hub - 9" Rnd Grate	Bl	1	4	\$83.25
860-6A	6" ABS Hub - 9" Rnd Grate	Bl	1	1	\$202.66
860-6P	6" PVC Hub - 9" Rnd Grate	Bl	1	1	\$202.66
<b>CAST IRON RING &amp; STRAINER</b>					
860-2AI	2" ABS Hub - 9-7/8" Rnd Grate	Bl	1	1	\$155.13
860-2PI	2" PVC Hub - 9-7/8" Rnd Grate	Bl	1	1	\$155.13
860-3AI	3" ABS Hub - 9-7/8" Rnd Grate	Bl	1	2	\$155.13
860-3PI	3" PVC Hub - 9-7/8" Rnd Grate	Bl	1	2	\$155.13
860-4AI	4" ABS Hub - 9-7/8" Rnd Grate	Bl	1	1	\$155.13
860-4PI	4" PVC Hub - 9-7/8" Rnd Grate	Bl	1	2	\$155.13
860-6AI	6" ABS Hub - 9-7/8" Rnd Grate	Bl	1	1	\$279.98
860-6PI	6" PVC Hub - 9-7/8" Rnd Grate	Bl	1	2	\$279.98



860-3PN



860-2AZ



860-2P



860-2PI

Supply

Drainage

Support

Specialties

Appendix

Supply

Drainage

Support

Specialties

Appendix



860-GP



860-S



860-D



864-2P



864-GP

**FatMax™ Floor Drain Accessories**

Item Number	Item Description	Pkg Type	Min Qty	Case Qty	Price
<b>STRAINERS</b>					
860-GA	ABS Full Strainer w/ Lift Handle	BI	1	12	\$36.19
<b>860-GA2</b>	ABS Open-Half Strainer	BI	1	1	\$24.38
860-GI	Cast Iron Full Strainer Only	BI	1	5	\$87.22
<b>860-GN</b>	Nckl-Brnz Full Strainer Only	BI	1	1	\$207.41
<b>860-GN2</b>	Nickl-Brnz Open-Half Strainer Only	BI	1	1	\$147.86
860-GP	PVC Full Strainer w/ Lift Handle	BI	1	16	\$36.19
860-GP2	PVC Open-Half Strainer	BI	1	10	\$24.38
<b>860-GPJ</b>	PVC Full Cover	BI	1	16	\$43.43
<b>860-RGN</b>	Nckl-Brnz Ring And Full Strainer	BI	1	1	\$305.00
860-RGN2	Nickl-Brnz Ring And Open-Half Strainer	BI	1	1	\$305.00
860-RGS	304 Stnls Steel Ring And Full Strainer	BI	1	1	\$305.00
860-RGS2	304 Stnls Steel Ring And Open-Half Strainer	BI	1	1	\$305.00
<b>ACCESSORIES</b>					
860-6	Flat Secondary Strainer - Gray ABS	BI	1	10	\$11.58
860-C	Clamping Collar w/ Screws - Gray ABS	BI	1	10	\$14.85
<b>860-CI</b>	Cast Iron Clamping Collar w/ Stainless Steel Screws	BI	1	10	\$26.93
860-D	Dome Bottom Strainer - Gray ABS	BI	1	80	\$9.42
860-S	Sand Bucket For Drain Sump Area - Gray ABS	BI	1	20	\$14.10
860-U	Debris Bucket For Drain Sump Area - Gray ABS	BI	1	20	\$14.10
860-UM	Stainless Steel Debris Basket	BI	1	5	\$53.08

**LittleMax™ General Purpose Floor Drain**

**Options:** Add suffix to item no. Add price to list

**V** = Vandal-Resistant Strainer: \$12.00; **T** = Tapped Trap Primer Connection - 1/2" FIP: \$8.00;

**S** = Sand Bucket: \$12.00; **U** = Stainless Steel Debris Basket for Sump Area: \$41.00;

**2** = Open-Half Strainer: \$20.00; **3** = Open-Quarter Strainer: \$20.00;

**X** = Less Strainer: N/C;

Item Number	Item Description	Pkg Type	Min Qty	Case Qty	Price
<b>DRAINS</b>					
864-2A	2" Hub - 6-5/8" Rnd ABS Grate	BI	1	3	\$55.15
864-2P	2" Hub - 6-5/8" Rnd ABS Grate	BI	1	3	\$55.15
864-3A	3" Hub - 6-5/8" Rnd ABS Grate	BI	1	3	\$55.15
864-3P	3" Hub - 6-5/8" Rnd ABS Grate	BI	1	3	\$55.15
<b>864-4A</b>	4" Hub - 6-5/8" Rnd ABS Grate	BI	1	3	\$55.15
864-4P	4" Hub - 6-5/8" Rnd ABS Grate	BI	1	3	\$55.15
<b>ACCESSORIES</b>					
<b>864-GP</b>	PVC Strainer w/ Lift Handle, Loose Set	BI	1	1	\$19.99
864-S	PVC Sand Bucket (Fits Inside Sump Area)	BI	1	10	\$12.41
864-UM	Stainless Steel Mesh Debris Basket	BI	1	10	\$41.36

**PVC/ABS - Sch. 40 Hub Connection**

**6-1/2" Tops**

Options: Add suffix to item no. Add price to list

V = Vandal-Resistant Strainer: \$6.50; H = Hinged Strainer: \$16.00;

E = Extended Ring: \$78.00; B = Complies with Buy American Act: \$62.00;

Item Number	Item Description	Pkg Type	Min Qty	Case Qty	Price
<b>ROUGH-IN FIXTURE</b>					
833-2AF	2" ABS Hub	Bl	1	10	\$44.93
833-2PF	2" PVC Hub	Bl	1	10	\$44.93
833-3AF	3" ABS Hub	Bl	1	1	\$44.93
833-3PF	3" PVC Hub	Bl	1	10	\$44.93
833-4AF	4" ABS Hub	Bl	1	10	\$44.93
833-4PF	4" PVC Hub	Bl	1	10	\$44.93
<b>FINISH FIXTURE</b>					
832-4HNQ	7" Sqr Nikl-Brnz Ring & Strainer	Bl	1	10	\$96.41
832-4HNR	6-1/2" Rnd Nikl-Brnz Ring & Strainer	Bl	1	10	\$64.92
832-4HSQ	7" Sqr Stnls Steel Ring & Strainer	Bl	1	1	\$96.41
832-4HSR	6-1/2" Rnd Stnls Steel Ring & Strainer	Bl	1	10	\$64.92
<b>COMPLETE ASSEMBLY</b>					
<b>833-2ANQ</b>	2" ABS Hub - 7" Sqr Nikl-Brnz Ring & Strainer	Bl	1	1	\$140.42
833-2ANR	2" ABS Hub - 6-1/2" Rnd Nikl-Brnz Ring & Strainer	Bl	1	1	\$109.20
<b>833-2ASQ</b>	2" ABS Hub - 7" Sqr Stnls Steel Ring & Strainer	Bl	1	1	\$140.42
833-2ASR	2" ABS Hub - 6-1/2" Rnd Stnls Steel Ring & Strainer	Bl	1	1	\$109.20
833-2PNQ	2" PVC Hub - 7" Sqr Nikl-Brnz Ring & Strainer	Bl	1	1	\$140.42
833-2PNR	2" PVC Hub - 6-1/2" Rnd Nikl-Brnz Ring & Strainer	Bl	1	1	\$109.20
<b>833-2PSQ</b>	2" PVC Hub - 7" Sqr Stnls Steel Ring & Strainer	Bl	1	1	\$140.42
<b>833-2PSR</b>	2" PVC Hub - 6-1/2" Rnd Stnls Steel Ring & Strainer	Bl	1	1	\$109.20
<b>833-3ANQ</b>	3" ABS Hub - 7" Sqr Nikl-Brnz Ring & Strainer	Bl	1	1	\$140.42
833-3ANR	3" ABS Hub - 6-1/2" Rnd Nikl-Brnz Ring & Strainer	Bl	1	1	\$109.20
<b>833-3ASQ</b>	3" ABS Hub - 7" Sqr Stnls Steel Ring & Strainer	Bl	1	1	\$140.42
<b>833-3ASR</b>	3" ABS Hub - 6-1/2" Rnd Stnls Steel Ring & Strainer	Bl	1	1	\$109.20
833-3PNQ	3" PVC Hub - 7" Sqr Nikl-Brnz Ring & Strainer	Bl	1	1	\$140.42
833-3PNR	3" PVC Hub - 6-1/2" Rnd Nikl-Brnz Ring & Strainer	Bl	1	1	\$109.20
<b>833-3PSQ</b>	3" PVC Hub - 7" Sqr Stnls Steel Ring & Strainer	Bl	1	1	\$140.42
<b>833-3PSR</b>	3" PVC Hub - 6-1/2" Rnd Stnls Steel Ring & Strainer	Bl	1	1	\$109.20
<b>833-4ANQ</b>	4" ABS Hub - 7" Sqr Nikl-Brnz Ring & Strainer	Bl	1	1	\$140.42
833-4ANR	4" ABS Hub - 6-1/2" Rnd Nikl-Brnz Ring & Strainer	Bl	1	1	\$109.20
<b>833-4ASQ</b>	4" ABS Hub - 7" Sqr Stnls Steel Ring & Strainer	Bl	1	1	\$140.42
<b>833-4ASR</b>	4" ABS Hub - 6-1/2" Rnd Stnls Steel Ring & Strainer	Bl	1	1	\$109.20
833-4PNQ	4" PVC Hub - 7" Sqr Nikl-Brnz Ring & Strainer	Bl	1	1	\$140.42
833-4PNR	4" PVC Hub - 6-1/2" Rnd Nikl-Brnz Ring & Strainer	Bl	1	1	\$109.20
<b>833-4PSQ</b>	4" PVC Hub - 7" Sqr Stnls Steel Ring & Strainer	Bl	1	1	\$140.42
833-4PSR	4" PVC Hub - 6-1/2" Rnd Stnls Steel Ring & Strainer	Bl	1	1	\$109.20



833-3PF



832-4HNQ



833-2PSR

Supply

Drainage

Support

Specialties

Appendix

Supply

Drainage

Support

Specialties

Appendix



832-P

**PVC/ABS - Sch. 40 Hub Connection (Cont)**  
**6-1/2" Tops**

Item Number	Item Description	Pkg Type	Min Qty	Case Qty	Price
<b>ACCESSORIES</b>					
832-4HHD	Hub Drain Finish Fixture for 6-1/2" Top	BI	1	10	\$18.91
832-4HPR	Finish Fixture with 6-1/2" Rnd ABS Ring & Strainer	BI	1	10	\$34.63
832-EX4	Ductile Iron Extension Adapter - 2" Min - 4" Max	BI	1	1	\$34.14
832-P	Coring Plug Wrench	BI	1	1	\$24.65
832-S4	Two Adjustment Shims, Two 3/4" Screws	BI	1	10	\$6.10
832-UM	4-1/4" Stainless Steel Debris Basket	BI	1	15	\$21.43
832-W	Flexible Red Locating Bristles w/ Screw	BI	1	10	\$7.26
835-2	Trapshield™ For 2" Drain Outlet	BI	1	50	\$56.31
835-3	Trapshield™ For 3" Drain Outlet	BI	1	25	\$63.36
835-4	Trapshield™ For 4" Drain Outlet	BI	1	20	\$74.98
863-FA	Round Aluminum Condensate Funnel w/ Screws	BI	1	12	\$49.15
863-FN	Round Nikl-Brnz Condensate Funnel w/ Screws	BI	1	12	\$109.99
863-FNO	Oval Nikl-Brnz Condensate Funnel w/ Screws	BI	1	12	\$243.96



833-25PF



832-3HNQ

**PVC/ABS - Sch. 40 Hub Connection**  
**5-1/2" Tops**

· Cast iron base adapter with ABS clamping collar, coring sleeve, and head adapter.

**Options:** Add suffix to item no. Add price to list

**V** = Vandal-Resistant Strainer: \$6.50; **B** = Complies with Buy American Act (1): \$62.00;

**E** = Extended Ring (1): \$78.00;

1: For round nickel bronze ring/strainer only

Item Number	Item Description	Pkg Type	Min Qty	Case Qty	Price
<b>ROUGH-IN FIXTURE</b>					
<b>833-25AF</b>	2" ABS Hub	BI	1	1	\$39.35
<b>833-25PF</b>	2" PVC Hub	BI	1	1	\$39.35
<b>833-35AF</b>	3" ABS Hub	BI	1	1	\$39.35
<b>833-35PF</b>	3" PVC Hub	BI	1	1	\$39.35
<b>FINISH FIXTURE</b>					
832-3HNQ	5-7/8" Sqr Nikl-Brnz Ring & Strainer	BI	1	10	\$65.56
832-3HNR	5-1/2" Rnd Nikl-Brnz Ring & Strainer	BI	1	10	\$46.64
<b>832-3HSQ</b>	5-7/8" Sqr Stnls Steel Ring & Strainer	BI	1	10	\$65.56
832-3HSR	5-1/2" Rnd Stnls Steel Ring & Strainer	BI	1	10	\$46.64

**PVC/ABS - Sch. 40 Hub Connection (Cont)**

**5-1/2" Tops**

Item Number	Item Description	Pkg Type	Min Qty	Case Qty	Price
<b>COMPLETE ASSEMBLY</b>					
833-25ANQ	2" ABS Hub - 5-7/8" Sqr Nikl-Brnz Ring & Strainer	Bl	1	1	\$109.18
833-25ANR	2" ABS Hub - 5-1/2" Rnd Nikl-Brnz Ring & Strainer	Bl	1	1	\$89.58
833-25ASQ	2" ABS Hub - 5-7/8" Sqr Stnls Steel Ring & Strainer	Bl	1	1	\$109.18
833-25ASR	2" ABS Hub - 5-1/2" Rnd Stnls Steel Ring & Strainer	Bl	1	1	\$89.58
833-25PNQ	2" PVC Hub - 5-7/8" Sqr Nikl-Brnz Ring & Strainer	Bl	1	1	\$109.18
833-25PNR	2" PVC Hub - 5-1/2" Rnd Nikl-Brnz Ring & Strainer	Bl	1	1	\$89.58
833-25PSQ	2" PVC Hub - 5-7/8" Sqr Stnls Steel Ring & Strainer	Bl	1	1	\$109.18
833-25PSR	2" PVC Hub - 5-1/2" Rnd Stnls Steel Ring & Strainer	Bl	1	1	\$89.58
833-35ANQ	3" ABS Hub - 5-7/8" Sqr Nikl-Brnz Ring & Strainer	Bl	1	1	\$104.22
833-35ANR	3" ABS Hub - 5-1/2" Rnd Nikl-Brnz Ring & Strainer	Bl	1	1	\$85.51
833-35ASQ	3" ABS Hub - 5-7/8" Sqr Stnls Steel Ring & Strainer	Bl	1	1	\$104.22
833-35ASR	3" ABS Hub - 5-1/2" Rnd Stnls Steel Ring & Strainer	Bl	1	1	\$85.51
833-35PNQ	3" PVC Hub - 5-7/8" Sqr Nikl-Brnz Ring & Strainer	Bl	1	1	\$104.22
833-35PNR	3" PVC Hub - 5-1/2" Rnd Nikl-Brnz Ring & Strainer	Bl	1	1	\$85.51
833-35PSQ	3" PVC Hub - 5-7/8" Sqr Stnls Steel Ring & Strainer	Bl	1	1	\$104.22
833-35PSR	3" PVC Hub - 5-1/2" Rnd Stnls Steel Ring & Strainer	Bl	1	1	\$85.51
<b>ACCESSORIES</b>					
832-3HHD	Hub Drain Finish Fixture for 5-1/2" Top	Bl	1	10	\$15.64
832-3HS	Finish Fixture with Rnd 5-1/2" 18-Ga Stnls Steel Strainer	B	1	20	\$19.80
832-EPS3	Extended ABS Coring Sleeve & Plug	Bl	1	1	\$15.82
832-EX3	Ductile Iron Extension Adapter - 2" Min - 3-3/8" Max	Bl	1	1	\$34.14
832-P	Coring Plug Wrench	Bl	1	1	\$24.65
832-S3	Two Adjustment Shims, Two 3/4" Screws	Bl	1	10	\$6.10
832-W	Flexible Red Locating Bristles w/ Screw	Bl	1	10	\$7.26
835-2	Trapshield™ For 2" Drain Outlet	Bl	1	50	\$56.31
835-3	Trapshield™ For 3" Drain Outlet	Bl	1	25	\$63.36
863-FA	Round Aluminum Condensate Funnel w/ Screws	Bl	1	12	\$49.15
863-FN	Round Nikl-Brnz Condensate Funnel w/ Screws	Bl	1	12	\$109.99
863-FNO	Oval Nikl-Brnz Condensate Funnel w/ Screws	Bl	1	12	\$243.96



833-35ANR



832-EPS3

Supply

Drainage

Support

Specialties

Appendix



833-22F



832-4HNQ



833-22NR

## ABS on Iron - No-Hub Connection

### 6-1/2" Tops

· Cast iron base adapter with ABS clamping collar, coring sleeve, and head adapter.

**Options:** Add suffix to item no. Add price to list

**V** = Vandal-Resistant Strainer: \$6.50; **H** = Hinged Strainer: \$16.00;

**E** = Extended Ring (1): \$78.00; **B** = Complies with Buy American Act (1): \$62.00;

1: For round nickel-bronze ring/strainer only

Item Number	Item Description	Pkg Type	Min Qty	Case Qty	Price
<b>ROUGH-IN FIXTURE</b>					
833-22F	2" No-Hub	BI	1	1	\$66.18
833-23F	3" No-Hub	BI	1	1	\$66.18
833-24F	4" No-Hub	BI	1	1	\$66.18
<b>FINISH FIXTURE</b>					
832-4HNQ	7" Sqr Nikl-Brnz Ring & Strainer	BI	1	10	\$96.41
832-4HNR	6-1/2" Rnd Nikl-Brnz Ring & Strainer	BI	1	10	\$64.92
832-4HSQ	7" Sqr Stnls Steel Ring & Strainer	BI	1	1	\$96.41
832-4HSR	6-1/2" Rnd Stnls Steel Ring & Strainer	BI	1	10	\$64.92
<b>COMPLETE ASSEMBLY</b>					
<b>833-22NQ</b>	2" No-Hub - 7" Sqr Nikl-Brnz Ring & Strainer	BI	1	1	\$175.70
833-22NR	2" No-Hub - 6-1/2" Rnd Nikl-Brnz Ring & Strainer	BI	1	1	\$140.08
<b>833-22SQ</b>	2" No-Hub - 7" Sqr Stnls Steel Ring & Strainer	BI	1	1	\$175.70
833-22SR	2" No-Hub - 6-1/2" Rnd Stnls Steel Ring & Strainer	BI	1	1	\$140.08
<b>833-23NQ</b>	3" No-Hub - 7" Sqr Nikl-Brnz Ring & Strainer	BI	1	1	\$175.70
833-23NR	3" No-Hub - 6-1/2" Rnd Nikl-Brnz Ring & Strainer	BI	1	1	\$140.08
<b>833-23SQ</b>	3" No-Hub - 7" Sqr Stnls Steel Ring & Strainer	BI	1	1	\$175.70
833-23SR	3" No-Hub - 6-1/2" Rnd Stnls Steel Ring & Strainer	BI	1	1	\$140.08
<b>833-24NQ</b>	4" No-Hub - 7" Sqr Nikl-Brnz Ring & Strainer	BI	1	1	\$175.70
833-24NR	4" No-Hub - 6-1/2" Rnd Nikl-Brnz Ring & Strainer	BI	1	1	\$140.08
<b>833-24SQ</b>	4" No-Hub - 7" Sqr Stnls Steel Ring & Strainer	BI	1	1	\$175.70
833-24SR	4" No-Hub - 6-1/2" Rnd Stnls Steel Ring & Strainer	BI	1	1	\$140.08



**ABS on Iron - No-Hub Connection (Cont)**

**6-1/2" Tops**

Item Number	Item Description	Pkg Type	Min Qty	Case Qty	Price
<b>ACCESSORIES</b>					
832-4HHD	Hub Drain Finish Fixture for 6-1/2" Top	Bl	1	10	\$18.91
832-4HPR	Finish Fixture with 6-1/2" Rnd ABS Ring & Strainer	Bl	1	10	\$34.63
832-EX4	Ductile Iron Extension Adapter - 2" Min - 4" Max	Bl	1	1	\$34.14
832-P	Coring Plug Wrench	Bl	1	1	\$24.65
832-S4	Two Adjustment Shims, Two 3/4" Screws	Bl	1	10	\$6.10
832-UM	4-1/4" Stainless Steel Debris Basket	Bl	1	15	\$21.43
832-W	Flexible Red Locating Bristles w/ Screw	Bl	1	10	\$7.26
835-2	Trapshield™ For 2" Drain Outlet	Bl	1	50	\$56.31
835-3	Trapshield™ For 3" Drain Outlet	Bl	1	25	\$63.36
835-4	Trapshield™ For 4" Drain Outlet	Bl	1	20	\$74.98
863-FA	Round Aluminum Condensate Funnel w/ Screws	Bl	1	12	\$49.15
863-FN	Round Nikl-Brnz Condensate Funnel w/ Screws	Bl	1	12	\$109.99
863-FNO	Oval Nikl-Brnz Condensate Funnel w/ Screws	Bl	1	12	\$243.96



832-4HHD

**ABS on Iron - No-Hub Connection**

**5-1/2" Tops**

**Options:** Add suffix to item no. Add price to list

**V** = Vandal-Resistant Strainer: \$6.50; **B** = Complies with Buy American Act (1): \$62.00;

**E** = Extended Ring (2): \$78.00;

1: For round nickel-bronzed ring/strainer only 2: For round nickel-bronze ring/strainer only

Item Number	Item Description	Pkg Type	Min Qty	Case Qty	Price
<b>ROUGH-IN FIXTURE</b>					
833-225F	2" No-Hub	Bl	1	1	\$62.03
833-235F	3" No-Hub	Bl	1	1	\$62.03
<b>FINISH FIXTURE</b>					
832-3HNQ	5-7/8" Sqr Nikl-Brnz Ring & Strainer	Bl	1	10	\$65.56
832-3HNR	5-1/2" Rnd Nikl-Brnz Ring & Strainer	Bl	1	10	\$46.64
832-3HSQ	5-7/8" Sqr Stnls Steel Ring & Strainer	Bl	1	10	\$65.56
832-3HSR	5-1/2" Rnd Stnls Steel Ring & Strainer	Bl	1	10	\$46.64
<b>COMPLETE ASSEMBLY</b>					
833-225NQ	2" No-Hub - 5-7/8" Sqr Nikl-Brnz Ring & Strainer	Bl	1	1	\$136.82
833-225NR	2" No-Hub - 5-1/2" Rnd Nikl-Brnz Ring & Strainer	Bl	1	1	\$115.15
833-225SQ	2" No-Hub - 5-7/8" Sqr Stnls Steel Ring & Strainer	Bl	1	1	\$136.82
833-225SR	2" No-Hub - 5-1/2" Rnd Stnls Steel Ring & Strainer	Bl	1	1	\$115.15
833-235NQ	3" No-Hub - 5-7/8" Sqr Nikl-Brnz Ring & Strainer	Bl	1	1	\$136.82
833-235NR	3" No-Hub - 5-1/2" Rnd Nikl-Brnz Ring & Strainer	Bl	1	1	\$115.15
833-235SQ	3" No-Hub - 5-7/8" Sqr Stnls Steel Ring & Strainer	Bl	1	1	\$136.82
833-235SR	3" No-Hub - 5-1/2" Rnd Stnls Steel Ring & Strainer	Bl	1	1	\$115.15



833-235F



832-3HSR



833-235SR

Supply

Drainage

Support

Specialties

Appendix



832-S3

### ABS on Iron - No-Hub Connection (Cont)

#### 5-1/2" Tops

Item Number	Item Description	Pkg Type	Min Qty	Case Qty	Price
<b>ACCESSORIES</b>					
832-3HHD	Hub Drain Finish Fixture for 5-1/2" Top	BI	1	10	\$15.64
832-3HS	Finish Fixture with Rnd 5-1/2" 18-Ga Stnls Steel Strainer	B	1	20	\$19.80
832-EX3	Ductile Iron Extension Adapter - 2" Min - 3-3/8" Max	BI	1	1	\$34.14
832-P	Coring Plug Wrench	BI	1	1	\$24.65
832-S3	Two Adjustment Shims, Two 3/4" Screws	BI	1	10	\$6.10
832-W	Flexible Red Locating Bristles w/ Screw	BI	1	10	\$7.26
835-2	Trapshield™ For 2" Drain Outlet	BI	1	50	\$56.31
835-3	Trapshield™ For 3" Drain Outlet	BI	1	25	\$63.36
863-FA	Round Aluminum Condensate Funnel w/ Screws	BI	1	12	\$49.15
863-FN	Round Nikl-Brnz Condensate Funnel w/ Screws	BI	1	12	\$109.99
863-FNO	Oval Nikl-Brnz Condensate Funnel w/ Screws	BI	1	12	\$243.96

### ABS on Iron - Push-Joint Connection

#### 6-1/2" Tops

· Cast iron base adapter with ABS clamping collar, coring sleeve, and head adapter.



833-62F



832-4HNQ

**Options:** Add suffix to item no. Add price to list

V = Vandal-Resistant Strainer: \$6.50; H = Hinged Strainer: \$16.00;

E = Extended Ring (1): \$78.00; B = Complies with Buy American Act (1): \$62.00;

P = Push-Joint Gasket to Fit Sch. 40 ABS/PVC Pipe (2): \$5.00;

1: For round nickel-bronze ring/strainer only 2: For 3" & 4" drains only

Item Number	Item Description	Pkg Type	Min Qty	Case Qty	Price
<b>ROUGH-IN FIXTURE</b>					
833-62F	2" PJ Conn.	BI	1	1	\$66.18
833-63F	3" PJ Conn.	BI	1	1	\$66.18
833-64F	4" PJ Conn.	BI	1	4	\$66.18
<b>FINISH FIXTURE</b>					
832-4HNQ	7" Sqr Nikl-Brnz Ring & Strainer	BI	1	10	\$96.41
832-4HNR	6-1/2" Rnd Nikl-Brnz Ring & Strainer	BI	1	10	\$64.92
832-4HSQ	7" Sqr Stnls Steel Ring & Strainer	BI	1	1	\$96.41
832-4HSR	6-1/2" Rnd Stnls Steel Ring & Strainer	BI	1	10	\$64.92

**ABS on Iron - Push-Joint Connection (Cont)**

**6-1/2" Tops**

Item Number	Item Description	Pkg Type	Min Qty	Case Qty	Price
<b>COMPLETE ASSEMBLY</b>					
833-62NQ	2" PJ Conn. - 7" Sqr Nikl-Brnz Ring & Strainer	Bl	1	1	\$175.70
833-62NR	2" PJ Conn. - 6-1/2" Rnd Nikl-Brnz Ring & Strainer	Bl	1	1	\$140.08
833-62SQ	2" PJ Conn. - 7" Sqr Stnls Steel Ring & Strainer	Bl	1	1	\$175.70
833-62SR	2" PJ Conn. - 6-1/2" Rnd Stnls Steel Ring & Strainer	Bl	1	1	\$140.08
833-63NQ	3" PJ Conn. - 7" Sqr Nikl-Brnz Ring & Strainer	Bl	1	1	\$175.70
833-63NR	3" PJ Conn. - 6-1/2" Rnd Nikl-Brnz Ring & Strainer	Bl	1	1	\$140.08
833-63SQ	3" PJ Conn. - 7" Sqr Stnls Steel Ring & Strainer	Bl	1	1	\$175.70
833-63SR	3" PJ Conn. - 6-1/2" Rnd Stnls Steel Ring & Strainer	Bl	1	1	\$140.08
833-64NQ	4" PJ Conn. - 7" Sqr Nikl-Brnz Ring & Strainer	Bl	1	1	\$175.70
833-64NR	4" PJ Conn. - 6-1/2" Rnd Nikl-Brnz Ring & Strainer	Bl	1	1	\$140.08
833-64SQ	4" PJ Conn. - 7" Sqr Stnls Steel Ring & Strainer	Bl	1	1	\$175.70
833-64SR	4" PJ Conn. - 6-1/2" Rnd Stnls Steel Ring & Strainer	Bl	1	1	\$140.08
<b>ACCESSORIES</b>					
832-4HHD	Hub Drain Finish Fixture for 6-1/2" Top	Bl	1	10	\$18.91
832-4HPR	Finish Fixture with 6-1/2" Rnd ABS Ring & Strainer	Bl	1	10	\$34.63
832-EX4	Ductile Iron Extension Adapter - 2" Min - 4" Max	Bl	1	1	\$34.14
832-P	Coring Plug Wrench	Bl	1	1	\$24.65
832-S4	Two Adjustment Shims, Two 3/4" Screws	Bl	1	10	\$6.10
832-UM	4-1/4" Stainless Steel Debris Basket	Bl	1	15	\$21.43
832-W	Flexible Red Locating Bristles w/ Screw	Bl	1	10	\$7.26
835-2	Trapshield™ For 2" Drain Outlet	Bl	1	50	\$56.31
835-3	Trapshield™ For 3" Drain Outlet	Bl	1	25	\$63.36
835-4	Trapshield™ For 4" Drain Outlet	Bl	1	20	\$74.98
858-PG3	Push-Joint Gasket For 3" Sch. 40 Pipe	Bl	1	20	\$16.17
858-PG4	Push-Joint Gasket For 4" Sch. 40 Pipe	Bl	1	20	\$15.48
863-FA	Round Aluminum Condensate Funnel w/ Screws	Bl	1	12	\$49.15
863-FN	Round Nikl-Brnz Condensate Funnel w/ Screws	Bl	1	12	\$109.99
863-FNO	Oval Nikl-Brnz Condensate Funnel w/ Screws	Bl	1	12	\$243.96



833-62NR



832-4HHD

Supply

Drainage

Support

Specialties

Appendix

**ABS on Iron - Push-Joint Connection**

**5-1/2" Tops**

· Cast iron base adapter with ABS clamping collar, coring sleeve, and head adapter.

**Options:** Add suffix to item no. Add price to list

**V** = Vandal-Resistant Strainer: \$6.50; **B** = Complies with Buy American Act (1): \$62.00;

**E** = Extended Ring (1): \$78.00; **P** = Push-Joint Gasket to Fit Sch. 40 ABS/PVC Pipe (2): \$5.00;

1: For round nickel-bronze ring/strainer only 2: For 3" drains only



833-625F



832-3HNR



833-625NQ



832-W

Item Number	Item Description	Pkg Type	Min Qty	Case Qty	Price
<b>ROUGH-IN FIXTURE</b>					
833-625F	2" PJ Conn.	BI	1	1	\$62.03
833-635F	3" PJ Conn.	BI	1	1	\$62.03
<b>FINISH FIXTURE</b>					
832-3HNQ	5-7/8" Sqr Nikl-Brnz Ring & Strainer	BI	1	10	\$65.56
832-3HNR	5-1/2" Rnd Nikl-Brnz Ring & Strainer	BI	1	10	\$46.64
832-3HSQ	5-7/8" Sqr Stnls Steel Ring & Strainer	BI	1	10	\$65.56
832-3HSR	5-1/2" Rnd Stnls Steel Ring & Strainer	BI	1	10	\$46.64
<b>COMPLETE ASSEMBLY</b>					
833-625NQ	2" PJ Conn. - 5-7/8" Sqr Nikl-Brnz Ring & Strainer	BI	1	1	\$136.82
833-625NR	2" PJ Conn. - 5-1/2" Rnd Nikl-Brnz Ring & Strainer	BI	1	1	\$115.15
833-625SQ	2" PJ Conn. - 5-7/8" Sqr Stnls Steel Ring & Strainer	BI	1	1	\$136.82
833-625SR	2" PJ Conn. - 5-1/2" Rnd Stnls Steel Ring & Strainer	BI	1	1	\$115.15
833-635NQ	3" PJ Conn. - 5-7/8" Sqr Nikl-Brnz Ring & Strainer	BI	1	1	\$136.82
833-635NR	3" PJ Conn. - 5-1/2" Rnd Nikl-Brnz Ring & Strainer	BI	1	1	\$115.15
833-635SQ	3" PJ Conn. - 5-7/8" Sqr Stnls Steel Ring & Strainer	BI	1	1	\$136.82
833-635SR	3" PJ Conn. - 5-1/2" Rnd Stnls Steel Ring & Strainer	BI	1	1	\$115.15
<b>ACCESSORIES</b>					
832-3HHD	Hub Drain Finish Fixture for 5-1/2" Top	BI	1	10	\$15.64
832-3HS	Finish Fixture with Rnd 5-1/2" 18-Ga Stnls Steel Strainer	B	1	20	\$19.80
832-EX3	Ductile Iron Extension Adapter - 2" Min - 3-3/8" Max	BI	1	1	\$34.14
832-P	Coring Plug Wrench	BI	1	1	\$24.65
832-S3	Two Adjustment Shims, Two 3/4" Screws	BI	1	10	\$6.10
832-W	Flexible Red Locating Bristles w/ Screw	BI	1	10	\$7.26
835-2	Trapshield™ For 2" Drain Outlet	BI	1	50	\$56.31
835-3	Trapshield™ For 3" Drain Outlet	BI	1	25	\$63.36
858-PG3	Push-Joint Gasket For 3" Sch. 40 Pipe	BI	1	20	\$16.17
863-FA	Round Aluminum Condensate Funnel w/ Screws	BI	1	12	\$49.15
863-FN	Round Nikl-Brnz Condensate Funnel w/ Screws	BI	1	12	\$109.99
863-FNO	Oval Nikl-Brnz Condensate Funnel w/ Screws	BI	1	12	\$243.96

Supply

Drainage

Support

Specialties

Appendix

**PVC/ABS - Sch. 40 Hub Connection**

**6-1/2" Tops**

**Options:** Add suffix to item no. Add price to list

**V** = Vandal-Resistant Strainer: \$6.50; **H** = Hinged Strainer: \$16.00;

**Y** = Ductile Iron Head Adapter (1): \$26.00; **D** = Ductile Iron Clamping Collar (1): \$26.00;

**T** = Tapped Trap Primer Connection - 1/2" FIP: \$12.00; **E** = Extended Ring (2): \$78.00;

**B** = Complies with Buy American Act (2): \$62.00; **M** = Medium-Duty Strainer (3,000 lbs. safe-load) (3): \$39.00;

1: In lieu of ABS (standard) 2: For round nickel-bronze ring/strainer only 3: For round 304 SS ring/strainer only



863-42NR



863-42NQ

Item Number	Item Description	Pkg Type	Min Qty	Case Qty	Price
<b>NICKEL-BRONZE RING &amp; STRAINER</b>					
863-32NQ	2" ABS Hub - 7" Sqr Ring & Strainer	Bl	1	2	\$142.95
863-32NR	2" ABS Hub - 6-1/2" Rnd Ring & Strainer	Bl	1	6	\$106.95
863-33NQ	3" ABS Hub - 7" Sqr Ring & Strainer	Bl	1	1	\$142.95
863-33NR	3" ABS Hub - 6-1/2" Rnd Ring & Strainer	Bl	1	6	\$106.95
863-34NQ	4" ABS Hub - 7" Sqr Ring & Strainer	Bl	1	2	\$142.95
863-34NR	4" ABS Hub - 6-1/2" Rnd Ring & Strainer	Bl	1	6	\$106.95
863-42NQ	2" PVC Hub - 7" Sqr Ring & Strainer	Bl	1	2	\$142.95
863-42NR	2" PVC Hub - 6-1/2" Rnd Ring & Strainer	Bl	1	6	\$106.95
863-43NQ	3" PVC Hub - 7" Sqr Ring & Strainer	Bl	1	2	\$142.95
863-43NR	3" PVC Hub - 6-1/2" Rnd Ring & Strainer	Bl	1	6	\$106.95
863-44NQ	4" PVC Hub - 7" Sqr Ring & Strainer	Bl	1	2	\$142.95
863-44NR	4" PVC Hub - 6-1/2" Rnd Ring & Strainer	Bl	1	6	\$106.95
<b>STAINLESS STEEL RING &amp; STRAINER</b>					
863-32SQ	2" ABS Hub - 7" Sqr Ring & Strainer	Bl	1	2	\$142.95
863-32SR	2" ABS Hub - 6-1/2" Rnd Ring & Strainer	Bl	1	6	\$106.95
863-33SQ	3" ABS Hub - 7" Sqr Ring & Strainer	Bl	1	2	\$142.95
863-33SR	3" ABS Hub - 6-1/2" Rnd Ring & Strainer	Bl	1	6	\$106.95
863-34SQ	4" ABS Hub - 7" Sqr Ring & Strainer	Bl	1	2	\$142.95
863-34SR	4" ABS Hub - 6-1/2" Rnd Ring & Strainer	Bl	1	6	\$106.95
863-42SQ	2" PVC Hub - 7" Sqr Ring & Strainer	Bl	1	1	\$142.95
863-42SR	2" PVC Hub - 6-1/2" Rnd Ring & Strainer	Bl	1	6	\$106.95
863-43SQ	3" PVC Hub - 7" Sqr Ring & Strainer	Bl	1	1	\$142.95
863-43SR	3" PVC Hub - 6-1/2" Rnd Ring & Strainer	Bl	1	1	\$106.95
863-44SQ	4" PVC Hub - 7" Sqr Ring & Strainer	Bl	1	1	\$142.95
863-44SR	4" PVC Hub - 6-1/2" Rnd Ring & Strainer	Bl	1	1	\$106.95
<b>ACCESSORIES</b>					
835-2	Trapshield™ For 2" Drain Outlet	Bl	1	50	\$56.31
835-3	Trapshield™ For 3" Drain Outlet	Bl	1	25	\$63.36
835-35	Trapshield™ For 3-1/2" Drain Head	Bl	1	25	\$63.36
835-4	Trapshield™ For 4" Drain Outlet	Bl	1	20	\$74.98
842-UM	4-5/8" Stainless Steel Debris Basket	Bl	1	1	\$21.67
863-FA	Round Aluminum Condensate Funnel w/ Screws	Bl	1	12	\$49.15
863-FN	Round Nikl-Brnz Condensate Funnel w/ Screws	Bl	1	12	\$109.99
863-FNO	Oval Nikl-Brnz Condensate Funnel w/ Screws	Bl	1	12	\$243.96

Supply

Drainage

Support

Specialties

Appendix



863-435NR



863-425SQ

## PVC/ABS - Sch. 40 Hub Connection

### 5-1/2" Tops

**Options:** Add suffix to item no. Add price to list

**V** = Vandal-Resistant Strainer: \$6.50; **Y** = Ductile Iron Head Adapter (1): \$26.00;

**D** = Ductile Iron Clamping Collar (1): \$26.00; **T** = Tapped Trap Primer Connection - 1/2" FIP: \$12.00;

**E** = Extended Ring (2): \$78.00; **B** = Complies with Buy American Act (2): \$62.00;

1: In lieu of ABS (standard) 2: For round nickel-bronze ring/strainer only

Item Number	Item Description	Pkg Type	Min Qty	Case Qty	Price
<b>NICKEL-BRONZE RING &amp; STRAINER</b>					
863-325NQ	2" ABS Hub - 5-7/8" Sqr Ring & Strainer	BI	1	2	\$111.38
863-325NR	2" ABS Hub - 5-1/2" Rnd Ring & Strainer	BI	1	6	\$90.38
<b>863-335NQ</b>	3" ABS Hub - 5-7/8" Sqr Ring & Strainer	BI	1	2	\$111.38
863-335NR	3" ABS Hub - 5-1/2" Rnd Ring & Strainer	BI	1	6	\$90.38
<b>863-345NQ</b>	4" ABS Hub - 5-7/8" Sqr Ring & Strainer	BI	1	2	\$142.95
<b>863-345NR</b>	4" ABS Hub - 5-1/2" Rnd Ring & Strainer	BI	1	6	\$106.95
863-425NQ	2" PVC Hub - 5-7/8" Sqr Ring & Strainer	BI	1	2	\$142.95
863-425NR	2" PVC Hub - 5-1/2" Rnd Ring & Strainer	BI	1	6	\$106.95
863-435NQ	3" PVC Hub - 5-7/8" Sqr Ring & Strainer	BI	1	2	\$111.38
863-435NR	3" PVC Hub - 5-1/2" Rnd Ring & Strainer	BI	1	6	\$90.38
<b>863-445NQ</b>	4" PVC Hub - 5-7/8" Sqr Ring & Strainer	BI	1	1	\$142.95
<b>863-445NR</b>	4" PVC Hub - 5-1/2" Rnd Ring & Strainer	BI	1	6	\$106.95
<b>STAINLESS STEEL RING &amp; STRAINER</b>					
<b>863-325SQ</b>	2" ABS Hub - 5-7/8" Sqr Ring & Strainer	BI	1	2	\$111.38
863-325SR	2" ABS Hub - 5-1/2" Rnd Ring & Strainer	BI	1	6	\$90.38
<b>863-335SQ</b>	3" ABS Hub - 5-7/8" Sqr Ring & Strainer	BI	1	2	\$111.38
<b>863-335SR</b>	3" ABS Hub - 5-1/2" Rnd Ring & Strainer	BI	1	6	\$90.38
<b>863-425SQ</b>	2" PVC Hub - 5-7/8" Sqr Ring & Strainer	BI	1	2	\$142.95
<b>863-425SR</b>	2" PVC Hub - 5-1/2" Rnd Ring & Strainer	BI	1	1	\$106.95
<b>863-435SQ</b>	3" PVC Hub - 5-7/8" Sqr Ring & Strainer	BI	1	2	\$111.38
863-435SR	3" PVC Hub - 5-1/2" Rnd Ring & Strainer	BI	1	6	\$90.38
<b>ACCESSORIES</b>					
822-EX3	Ductile Iron Extension Adapter	B	1	1	\$35.33
835-2	Trapshield™ For 2" Drain Outlet	BI	1	50	\$56.31
835-3	Trapshield™ For 3" Drain Outlet	BI	1	25	\$63.36
835-35	Trapshield™ For 3-1/2" Drain Head	BI	1	25	\$63.36
835-4	Trapshield™ For 4" Drain Outlet	BI	1	20	\$74.98
863-FA	Round Aluminum Condensate Funnel w/ Screws	BI	1	12	\$49.15
863-FN	Round Nikl-Brnz Condensate Funnel w/ Screws	BI	1	12	\$109.99

**ABS on Iron - No-Hub Connection**

· Cast iron base adapter with ABS clamping collar and head adapter.

**Options:** Add suffix to item no. Add price to list

**V** = Vandal-Resistant Strainer: \$6.50; **H** = Hinged Strainer: \$16.00;  
**Y** = Ductile Iron Head Adapter (1): \$26.00; **D** = Ductile Iron Clamping Collar (1): \$26.00;  
**E** = Extended Ring (2): \$78.00; **B** = Complies with Buy American Act (2): \$62.00;  
**M** = Medium-Duty Strainer (3,000 lbs. safe-load) (3): \$39.00;

1: In lieu of ABS (standard) 2: For round nickel-bronze ring/strainer only 3: For round 304 SS ring/strainer only



863-24NQ

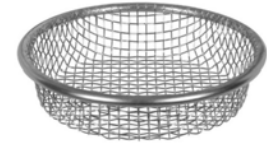

842-UM

Item Number	Item Description	Pkg Type	Min Qty	Case Qty	Price
<b>NICKEL-BRONZE RING &amp; STRAINER</b>					
863-22NQ	2" No-Hub - 7" Sqr Ring & Strainer	Bl	1	2	\$207.40
863-22NR	2" No-Hub - 6-1/2" Rnd Ring & Strainer	Bl	1	3	\$171.40
863-23NQ	3" No-Hub - 7" Sqr Ring & Strainer	Bl	1	2	\$207.40
863-23NR	3" No-Hub - 6-1/2" Rnd Ring & Strainer	Bl	1	2	\$171.40
863-24NQ	4" No-Hub - 7" Sqr Ring & Strainer	Bl	1	1	\$207.40
863-24NR	4" No-Hub - 6-1/2" Rnd Ring & Strainer	Bl	1	1	\$171.40
<b>STAINLESS STEEL RING &amp; STRAINER</b>					
863-22SQ	2" No-Hub - 7" Sqr Ring & Strainer	Bl	1	1	\$207.40
863-22SR	2" No-Hub - 6-1/2" Rnd Ring & Strainer	Bl	1	1	\$171.40
863-23SQ	3" No-Hub - 7" Sqr Ring & Strainer	Bl	1	1	\$207.40
863-23SR	3" No-Hub - 6-1/2" Rnd Ring & Strainer	Bl	1	1	\$171.40
863-24SQ	4" No-Hub - 7" Sqr Ring & Strainer	Bl	1	1	\$207.40
863-24SR	4" No-Hub - 6-1/2" Rnd Ring & Strainer	Bl	1	2	\$171.40
<b>ACCESSORIES</b>					
835-2	Trapshield™ For 2" Drain Outlet	Bl	1	50	\$56.31
835-3	Trapshield™ For 3" Drain Outlet	Bl	1	25	\$63.36
835-35	Trapshield™ For 3-1/2" Drain Head	Bl	1	25	\$63.36
835-4	Trapshield™ For 4" Drain Outlet	Bl	1	20	\$74.98
842-UM	4-5/8" Stainless Steel Debris Basket	Bl	1	1	\$21.67
863-FA	Round Aluminum Condensate Funnel w/ Screws	Bl	1	12	\$49.15
863-FN	Round Nikl-Brnz Condensate Funnel w/ Screws	Bl	1	12	\$109.99
863-FNO	Oval Nikl-Brnz Condensate Funnel w/ Screws	Bl	1	12	\$243.96

Supply

Drainage

Support

Specialties

Appendix



863-64NQ

### ABS on Iron - Push-Joint Connection

- Cast iron base adapter with ABS clamping collar and head adapter.

**Options:** Add suffix to item no. Add price to list

**V** = Vandal-Resistant Strainer: \$6.50; **H** = Hinged Strainer: \$16.00;

**Y** = Ductile Iron Head Adapter (1): \$26.00; **D** = Ductile Iron Clamping Collar (1): \$26.00;

**E** = Extended Ring (2): \$78.00; **B** = Complies with Buy American Act (2): \$62.00;

**P** = Push-Joint Gasket to fit Sch. 40 Pipe (3): \$5.00; **M** = Medium-Duty Strainer (3,000 lbs. safe-load) (4): \$39.00;

1: In lieu of ABS (standard) 2: For round nickel-bronze ring/strainer only 3: Not available for 2" drains 4: For round 304 SS ring/strainer only

Item Number	Item Description	Pkg Type	Min Qty	Case Qty	Price
<b>NICKEL-BRONZE RING &amp; STRAINER</b>					
<b>863-62NQ</b>	2" PJ Conn. - 7" Sqr Ring & Strainer	BI	1	1	\$207.40
863-62NR	2" PJ Conn. - 6-1/2" Rnd Ring & Strainer	BI	1	3	\$171.40
<b>863-63NQ</b>	3" PJ Conn. - 7" Sqr Ring & Strainer	BI	1	1	\$207.40
863-63NR	3" PJ Conn. - 6-1/2" Rnd Ring & Strainer	BI	1	2	\$171.40
<b>863-64NQ</b>	4" PJ Conn. - 7" Sqr Ring & Strainer	BI	1	1	\$207.40
863-64NR	4" PJ Conn. - 6-1/2" Rnd Ring & Strainer	BI	1	2	\$171.40
<b>STAINLESS STEEL RING &amp; STRAINER</b>					
<b>863-62SQ</b>	2" PJ Conn. - 7" Sqr Ring & Strainer	BI	1	1	\$207.40
<b>863-62SR</b>	2" PJ Conn. - 6-1/2" Rnd Ring & Strainer	BI	1	1	\$171.40
<b>863-63SQ</b>	3" PJ Conn. - 7" Sqr Ring & Strainer	BI	1	1	\$207.40
<b>863-63SR</b>	3" PJ Conn. - 6-1/2" Rnd Ring & Strainer	BI	1	1	\$171.40
<b>863-64SQ</b>	4" PJ Conn. - 7" Sqr Ring & Strainer	BI	1	1	\$207.40
<b>863-64SR</b>	4" PJ Conn. - 6-1/2" Rnd Ring & Strainer	BI	1	1	\$171.40
<b>ACCESSORIES</b>					
835-2	Trapshield™ For 2" Drain Outlet	BI	1	50	\$56.31
835-3	Trapshield™ For 3" Drain Outlet	BI	1	25	\$63.36
835-35	Trapshield™ For 3-1/2" Drain Head	BI	1	25	\$63.36
835-4	Trapshield™ For 4" Drain Outlet	BI	1	20	\$74.98
842-UM	4-5/8" Stainless Steel Debris Basket	BI	1	1	\$21.67
863-FA	Round Aluminum Condensate Funnel w/ Screws	BI	1	12	\$49.15
863-FN	Round Nikl-Brnz Condensate Funnel w/ Screws	BI	1	12	\$109.99
863-FNO	Oval Nikl-Brnz Condensate Funnel w/ Screws	BI	1	12	\$243.96



**Halo™ Floor Drains**

**PVC/ABS - Sch. 40 Hub Connection**

**Options:** Add suffix to item no. Add price to list

**M** = Clamping Collar Kit (1): \$19.50; **V** = Vandal-Resistant Strainer: \$6.50;

**B** = Complies with Buy American Act (2): \$62.00; **E** = Extended Ring (2): \$78.00;

1: Add 'M' after dash - all other options at end of item no. 2: For round nickel bronze ring/strainer only

Item Number	Item Description	Pkg Type	Min Qty	Case Qty	Price
<b>NICKEL-BRONZE RING &amp; STRAINER</b>					
822-2ANQ	2" ABS Hub - 5-7/8" Sqr Ring & Strainer	Bl	1	4	\$93.56
822-2ANR	2" ABS Hub - 5-1/2" Rnd Ring & Strainer	Bl	1	4	\$73.54
822-2PNQ	2" PVC Hub - 5-7/8" Sqr Ring & Strainer	Bl	1	4	\$93.56
822-2PNR	2" PVC Hub - 5-1/2" Rnd Ring & Strainer	Bl	1	4	\$73.54
822-3ANQ	3" ABS Hub - 5-7/8" Sqr Ring & Strainer	Bl	1	4	\$93.56
822-3ANR	3" ABS Hub - 5-1/2" Rnd Ring & Strainer	Bl	1	4	\$73.54
822-3PNQ	3" PVC Hub - 5-7/8" Sqr Ring & Strainer	Bl	1	4	\$93.56
822-3PNR	3" PVC Hub - 5-1/2" Rnd Ring & Strainer	Bl	1	4	\$73.54
<b>STAINLESS STEEL RING &amp; STRAINER</b>					
822-2ASQ	2" ABS Hub - 5-7/8" Sqr Ring & Strainer	Bl	1	4	\$93.56
822-2ASR	2" ABS Hub - 5-1/2" Rnd Ring & Strainer	Bl	1	4	\$73.54
822-2PSQ	2" PVC Hub - 5-7/8" Sqr Ring & Strainer	Bl	1	4	\$93.56
822-2PSR	2" PVC Hub - 5-1/2" Rnd Ring & Strainer	Bl	1	4	\$73.54
822-3ASQ	3" ABS Hub - 5-7/8" Sqr Ring & Strainer	Bl	1	4	\$93.56
822-3ASR	3" ABS Hub - 5-1/2" Rnd Ring & Strainer	Bl	1	1	\$73.54
822-3PSQ	3" PVC Hub - 5-7/8" Sqr Ring & Strainer	Bl	1	4	\$93.56
822-3PSR	3" PVC Hub - 5-1/2" Rnd Ring & Strainer	Bl	1	4	\$73.54
<b>18-GA STAINLESS STEEL STRAINER</b>					
822-2AS	2" ABS Hub - 5-3/8" Rnd Ring & Strainer	Bl	1	4	\$43.45
822-2PS	2" PVC Hub - 5-3/8" Rnd Ring & Strainer	Bl	1	4	\$43.45
822-3AS	3" ABS Hub - 5-3/8" Rnd Ring & Strainer	Bl	1	4	\$43.45
822-3PS	3" PVC Hub - 5-3/8" Rnd Ring & Strainer	Bl	1	4	\$43.45
<b>ACCESSORIES</b>					
822-CKIT	Clamping Collar Kit	Bl	1	10	\$21.79
822-EX3	Ductile Iron Extension Adapter	B	1	1	\$35.33
822-TB	Thread Bushing For Halo Head	Bl	1	10	\$20.45
835-2	Trapshield™ For 2" Drain Outlet	Bl	1	50	\$56.31
835-3	Trapshield™ For 3" Drain Outlet	Bl	1	25	\$63.36
835-35	Trapshield™ For 3-1/2" Drain Head	Bl	1	25	\$63.36
863-FA	Round Aluminum Condensate Funnel w/ Screws	Bl	1	12	\$49.15
863-FN	Round Nikl-Brnz Condensate Funnel w/ Screws	Bl	1	12	\$109.99
863-FNO	Oval Nikl-Brnz Condensate Funnel w/ Screws	Bl	1	12	\$243.96



822-3ANR



822-2PSQ

Supply

Drainage

Support

Specialties

Appendix

FinishLine Halo™ Floor Drains

PVC/ABS - Sch. 40 Hub Connection

Options: Add suffix to item no. Add price to list

M = Clamping Collar Kit (1): \$19.50; V = Vandal-Resistant Strainer: \$6.50;

B = Complies with Buy American Act (2): \$62.00; E = Extended Ring (2): \$78.00;

1: Add 'M' after dash - all other options at end of item no. 2: For round nickel bronze ring/strainer only



822-3PF



832-3HSQ



822-F2ANR

Item Number	Item Description	Pkg Type	Min Qty	Case Qty	Price
<b>ROUGH-IN FIXTURE</b>					
822-2AF	2" ABS Hub	BI	1	4	\$50.78
822-2PF	2" PVC Hub	BI	1	4	\$50.78
822-3AF	3" ABS Hub	BI	1	4	\$50.78
822-3PF	3" PVC Hub	BI	1	4	\$50.78
<b>FINISH FIXTURE</b>					
832-3HNQ	5-7/8" Sqr Nikl-Brnz Ring & Strainer	BI	1	10	\$65.56
832-3HNR	5-1/2" Rnd Nikl-Brnz Ring & Strainer	BI	1	10	\$46.64
832-3HSQ	5-7/8" Sqr Stnls Steel Ring & Strainer	BI	1	10	\$65.56
832-3HSR	5-1/2" Rnd Stnls Steel Ring & Strainer	BI	1	10	\$46.64
<b>COMPLETE ASSEMBLY</b>					
822-F2ANQ	2" ABS Hub - 5-7/8" Sqr Ring & Strainer	BI	1	1	\$120.31
822-F2ANR	2" ABS Hub - 5-1/2" Rnd Ring & Strainer	BI	1	1	\$100.27
822-F2ASQ	2" ABS Hub - 5-7/8" Sqr Ring & Strainer	BI	1	1	\$120.31
822-F2ASR	2" ABS Hub - 5-1/2" Rnd Ring & Strainer	BI	1	1	\$100.27
822-F2PNQ	2" PVC Hub - 5-7/8" Sqr Ring & Strainer	BI	1	1	\$120.31
822-F2PNR	2" PVC Hub - 5-1/2" Rnd Ring & Strainer	BI	1	1	\$100.27
822-F2PSQ	2" PVC Hub - 5-7/8" Sqr Ring & Strainer	BI	1	1	\$120.31
822-F2PSR	2" PVC Hub - 5-1/2" Rnd Ring & Strainer	BI	1	1	\$100.27
822-F3ANQ	3" ABS Hub - 5-7/8" Sqr Ring & Strainer	BI	1	1	\$120.31
822-F3ANR	3" ABS Hub - 5-1/2" Rnd Ring & Strainer	BI	1	1	\$100.27
822-F3ASQ	3" ABS Hub - 5-7/8" Sqr Ring & Strainer	BI	1	1	\$120.31
822-F3ASR	3" ABS Hub - 5-1/2" Rnd Ring & Strainer	BI	1	1	\$100.27
822-F3PNQ	3" ABS Hub - 5-7/8" Sqr Ring & Strainer	BI	1	1	\$120.31
822-F3PNR	3" ABS Hub - 5-1/2" Rnd Ring & Strainer	BI	1	1	\$100.27
822-F3PSQ	3" ABS Hub - 5-7/8" Sqr Ring & Strainer	BI	1	1	\$120.31
822-F3PSR	3" ABS Hub - 5-1/2" Rnd Ring & Strainer	BI	1	1	\$100.27

Supply

Drainage

Support

Specialties

Appendix

**FinishLine Halo™ Floor Drains (Cont)**

**PVC/ABS - Sch. 40 Hub Connection**

Item Number	Item Description	Pkg Type	Min Qty	Case Qty	Price
<b>ACCESSORIES</b>					
822-CKIT	Clamping Collar Kit	BI	1	10	\$21.79
822-EX3	Ductile Iron Extension Adapter	B	1	1	\$35.33
832-3HHD	Hub Drain Finish Fixture for 5-1/2" Top	BI	1	10	\$15.64
832-3HS	Finish Fixture with Rnd 5-1/2" 18-Ga Stnls Steel Strainer	B	1	20	\$19.80
832-EPS3	Extended ABS Coring Sleeve & Plug	BI	1	1	\$15.82
832-EX3	Ductile Iron Extension Adapter - 2" Min - 3-3/8" Max	BI	1	1	\$34.14
832-P	Coring Plug Wrench	BI	1	1	\$24.65
832-S3	Two Adjustment Shims, Two 3/4" Screws	BI	1	10	\$6.10
832-W	Flexible Red Locating Bristles w/ Screw	BI	1	10	\$7.26
835-2	Trapshield™ For 2" Drain Outlet	BI	1	50	\$56.31
835-3	Trapshield™ For 3" Drain Outlet	BI	1	25	\$63.36
863-FA	Round Aluminum Condensate Funnel w/ Screws	BI	1	12	\$49.15
863-FN	Round Nikl-Brnz Condensate Funnel w/ Screws	BI	1	12	\$109.99
863-FNO	Oval Nikl-Brnz Condensate Funnel w/ Screws	BI	1	12	\$243.96



822-EX3

Supply

Drainage

Support

Specialties

Appendix

Supply

Drainage

Support

Specialties

Appendix



835-2

**TrapShield™**

**Trap Protection Device**

Item Number	Item Description	Pkg Type	Min Qty	Case Qty	Price
835-2	Trapshield™ For 2" Drain Outlet	BI	1	50	\$56.31
835-3	Trapshield™ For 3" Drain Outlet	BI	1	25	\$63.36
835-35	Trapshield™ For 3-1/2" Drain Head	BI	1	25	\$63.36
835-4	Trapshield™ For 4" Drain Outlet	BI	1	20	\$74.98

**Replacement Strainers**



842-SNQ3



842-SCS2



842-SD4



842-SS2



842-SP2

Item Number	Item Description	Pkg Type	Min Qty	Case Qty	Price
<b>NICKEL-BRONZE STRAINERS</b>					
842-SN2	4" Dia. Rnd - 4.25 Sqr. Inch Free Area - 3" Screw Centers	BI	1	20	\$30.00
842-SN3	5-1/16" Dia. Rnd - 7.5 Sqr. Inch Free Area - 3-7/8" Screw Centers	BI	1	10	\$35.00
842-SN4	6-1/16" Dia. Rnd - 11.75 Sqr. Inch Free Area - 4-7/8" Screw Centers	BI	1	20	\$40.00
<b>842-SNQ2</b>	4" Dia. Sqr - 7.6 Sqr. Inch Free Area - 3" Screw Centers	BI	1	1	\$45.00
<b>842-SNQ3</b>	5-3/8" Dia. Sqr - 12.75 Sqr. Inch Free Area - 3-7/8" Screw Centers	BI	1	1	\$60.00
842-SNQ4	6-11/16" Dia. Sqr - 16.4 Sqr. Inch Free Area - 4-7/8" Screw Centers	BI	1	20	\$75.00
<b>CAST STAINLESS STEEL STRAINERS</b>					
<b>842-SCS2</b>	4" Dia. Rnd - 4.25 Sqr. Inch Free Area - 3" Screw Centers	BI	1	1	\$36.68
842-SCS3	5-1/8" Dia. Rnd - 7.5 Sqr. Inch Free Area - 3-7/8" Screw Centers	BI	1	10	\$54.88
<b>842-SCS4</b>	6-1/8" Dia. Rnd - 11.75 Sqr. Inch Free Area - 4-7/8" Screw Centers	BI	1	10	\$62.48
<b>842-SCSQ2</b>	4" Dia. Sqr - 7.6 Sqr. Inch Free Area - 3" Screw Centers	BI	1	1	\$51.85
<b>842-SCSQ3</b>	5-3/8" Dia. Sqr - 12.75 Sqr. Inch Free Area - 3-7/8" Screw Centers	BI	1	1	\$77.63
<b>842-SCSQ4</b>	6-1/2" Dia. Sqr - 16.4 Sqr. Inch Free Area - 4-7/8" Screw Centers	BI	1	1	\$100.38
<b>CAST IRON STRAINERS</b>					
842-SD4	6-1/16" Dia. Rnd - 13.25 Sqr. Inch Free Area - 4-7/8" Screw Centers	BI	1	1	\$16.23
<b>842-SI2</b>	4-1/2" Dia. Rnd - 4.18 Sqr. Inch Free Area	BI	1	1	\$26.00
<b>842-SI3</b>	5-5/8" Dia. Rnd - 6.81 Sqr. Inch Free Area	BI	1	10	\$28.50
<b>842-SI4</b>	6-3/16" Dia. Rnd - 9.58 Sqr. Inch Free Area	BI	1	2	\$31.00
<b>STAMPED STAINLESS STEEL STRAINERS</b>					
842-SS2	4" Dia. Rnd - 2.66 Sqr. Inch Free Area - 3" Screw Centers	BI	1	10	\$7.50
842-SS3	5-1/16" Dia. Rnd - 5.09 Sqr. Inch Free Area - 3-7/8" Screw Centers	BI	1	10	\$9.50
842-SS4	6-1/16" Dia. Rnd - 9.25 Sqr. Inch Free Area - 4-7/8" Screw Centers	BI	1	10	\$12.50
<b>GRAY ABS STRAINERS</b>					
<b>842-SP2</b>	4" Dia. Rnd - 4.18 Sqr. Inch Free Area - 3" Screw Centers	BI	1	1	\$8.00
842-SP3	5-1/16" Dia. Rnd - 5.15 Sqr. Inch Free Area - 3-7/8" Screw Centers	BI	1	10	\$10.00
842-SP4	6-1/16" Dia. Rnd - 8.74 Sqr. Inch Free Area - 4-7/8" Screw Centers	BI	1	10	\$13.00

## Floor Drain Adapters

### Trap Primer Adapters

Item Number	Item Description	Pkg Type	Min Qty	Case Qty	Price
<b>PVC/ABS - FIP X SCH. 40 HUB CONNECTION</b>					
842-82AT	2" ABS Hub w/ 1/2" FIP Trap Primer Port	BI	1	10	\$13.39
842-82PT	2" PVC Hub w/ 1/2" FIP Trap Primer Port	BI	1	10	\$13.39
<b>842-83AT</b>	3" ABS Hub w/ 1/2" FIP Trap Primer Port	BI	1	10	\$17.94
842-83PT	3" PVC Hub w/ 1/2" FIP Trap Primer Port	BI	1	10	\$17.94
842-84AT	4" ABS Hub w/ 1/2" FIP Trap Primer Port	BI	1	10	\$20.09
842-84PT	4" PVC Hub w/ 1/2" FIP Trap Primer Port	BI	1	10	\$20.09
<b>PVC/ABS - SCH. 40 HUB X SCH. 40 HUB CONNECTION</b>					
695-2A	2" ABS Hub Adapter w/ 1/2" FIP Port	BI	1	10	\$18.80
695-2P	2" PVC Hub Adapter w/ 1/2" FIP Port	BI	1	10	\$18.80
695-3A	3" ABS Hub Adapter w/ 1/2" FIP Port	B	1	10	\$21.32
695-3P	3" PVC Hub Adapter w/ 1/2" FIP Port	BI	1	10	\$21.32
695-4A	4" ABS Hub Adapter w/ 1/2" FIP Port	B	1	10	\$25.07
695-4P	4" PVC Hub Adapter w/ 1/2" FIP Port	BI	1	10	\$25.07



842-82PT



695-2P

## Floor Drain Adapters

### Flashing Drain Adapters

**Options:** Add suffix to item no. Add price to list  
 T = Tapped/plugged trap primer port for ABS/PVC: \$16.00;

Item Number	Item Description	Pkg Type	Min Qty	Case Qty	Price
<b>PVC/ABS - SCH. 40 HUB CONNECTION</b>					
863-HA23	2" ABS Hub w/ 3" FIP Thread	BI	1	10	\$43.43
<b>863-HA33</b>	3" ABS Hub w/ 3" FIP Thread	BI	1	10	\$43.43
<b>863-HA44</b>	4" ABS Hub w/ 4" FIP Thread	BI	1	10	\$43.43
863-HP23	2" PVC Hub w/ 3" FIP Thread	BI	1	10	\$43.43
<b>863-HP33</b>	3" PVC Hub w/ 3" FIP Thread	BI	1	10	\$43.43
863-HP34	3" PVC Hub w/ 4" FIP Thread	BI	1	10	\$43.43
863-HP44	4" PVC Hub w/ 4" FIP Thread	BI	1	10	\$43.43



863-HP23

## Condensate Funnels

Item Number	Item Description	Pkg Type	Min Qty	Case Qty	Price
<b>ROUND 4"</b>					
863-FA	Round Aluminum Condensate Funnel w/ Screws	BI	1	12	\$49.15
863-FN	Round Nikl-Brnz Condensate Funnel w/ Screws	BI	1	12	\$109.99
<b>OVAL 4" X 9"</b>					
863-FNO	Oval Nikl-Brnz Condensate Funnel w/ Screws	BI	1	12	\$243.96



863-FA

Supply

Drainage

Support

Specialties

Appendix

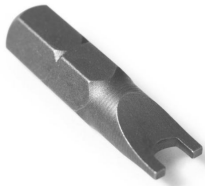

850-VW1

### Vandal-Resistant Strainer Screws

Item Number	Item Description	Pkg Type	Min Qty	Case Qty	Price
<b>10-24 SIZE</b>					
850-V105	1/2" Stainless, 12/Bag	BI	1	25	\$17.87
850-V106	5/8" Stainless, 12/Bag	BI	1	25	\$17.87
<b>850-V109</b>	1" Stainless, 12/Bag	BI	1	1	\$17.87
850-VW1	#10 Span For Most Drain Strainers And Cleanout Covers	BI	10	10	\$21.05
<b>1/4-20 SIZE</b>					
850-V407	3/4" Stainless	BI	1	1	\$4.50
850-V415	1-1/2" Stainless	BI	1	1	\$4.08
850-V425	2-1/2" Stainless	BI	1	1	\$4.08
850-VW4	#14 Span For 850 And 851 Series Covers	BI	10	10	\$21.05

# Commercial Floor Sinks

**SquareMax™ Square Floor Sinks**

**FatMax™ Round Floor Sinks**

**LittleMax™ Compact Floor Sinks**

Sioux Chief's PVC floor sinks are made from a tough, impact-modified PVC resin. They are corrosion-resistant and withstand water temperatures up to 180°F without distortion.







**PVC - Sch. 40 Hub Connection**

**Floor Sinks**

**Options:** Add suffix to item no. Add price to list

**D** = ABS Dome Bottom Strainer (1): \$10.00; **U** = Aluminum Dome Bottom Strainer (1): \$22.00;

**C** = PVC Clamping Collar: \$20.00; **W** = Stainless Steel Debris Basket: \$60.00;

**2** = Open-Half Strainer (2): N/C; **3** = Open-Quarter Strainer (2): N/C;

**V** = Vandal-Resistant Strainer (2): \$12.00; **T** = Tapped Trap Primer Connection - 1/2" FIP: \$12.00;

**F** = Round Nickel-Bronze Condensate Funnel: \$108.00; **FA** = Round Aluminum Condensate Funnel: \$48.00;

**FO** = Oval Nickel-Bronze Condensate Funnel: \$238.00; **6** = ABS Flat Strainer for Drain Outlet (1): \$12.00;

1: Not available for 6" sinks 2: Available for sinks with PVC, NB, and SS strainers only



861-2PX



861-2P



861-3PN



861-2PZ

Item Number	Item Description	Pkg Type	Min Qty	Case Qty	Price
<b>SINK ONLY - NO STRAINER</b>					
861-2PX	2" Hub	Bl	1	3	\$65.15
861-2PXR	2" Hub - No Anchor Flange	Bl	1	3	\$97.72
861-3PX	3" Hub	Bl	1	3	\$65.15
861-3PXR	3" Hub - No Anchor Flange	Bl	1	3	\$97.72
861-4PX	4" Hub	Bl	1	3	\$65.15
861-6PX	6" Hub	Bl	1	2	\$166.47
<b>PVC STRAINER</b>					
861-2P	2" Hub - 11-3/16" Sqr Grate	Bl	1	1	\$97.72
861-2PR	2" Hub - 11-3/16" Sqr Grate - No Anchor Flange	Bl	1	1	\$97.72
861-3P	3" Hub - 11-3/16" Sqr Grate	Bl	1	1	\$97.72
861-3PR	3" Hub - 11-3/16" Sqr Grate - No Anchor Flange	Bl	1	1	\$97.72
861-4P	4" Hub - 11-3/16" Sqr Grate	Bl	1	1	\$97.72
861-6P	6" Hub - 11-3/16" Sqr Grate	Bl	1	1	\$199.04
<b>NICKEL-BRONZE RING &amp; STRAINER</b>					
861-2PN	2" Hub - 11-3/4" Sqr Grate	Bl	1	1	\$571.82
861-3PN	3" Hub - 11-3/4" Sqr Grate	Bl	1	1	\$571.82
861-4PN	4" Hub - 11-3/4" Sqr Grate	Bl	1	1	\$571.82
861-6PN	6" Hub - 11-3/4" Sqr Grate	Bl	1	1	\$673.14
<b>STAINLESS STEEL RING &amp; STRAINER</b>					
861-2PZ	2" Hub - 11-3/4" Sqr Grate	Bl	1	1	\$571.82
861-3PZ	3" Hub - 11-3/4" Sqr Grate	Bl	1	1	\$571.82
861-4PZ	4" Hub - 11-3/4" Sqr Grate	Bl	1	1	\$571.82
861-6PZ	6" Hub - 11-3/4" Sqr Grate	Bl	1	1	\$673.14
<b>DUCTILE IRON RING &amp; STRAINER</b>					
861-2PI	2" Hub - 11-3/4" Sqr Grate	Bl	1	1	\$249.72
861-3PI	3" Hub - 11-3/4" Sqr Grate	Bl	1	1	\$249.72
861-4PI	4" Hub - 11-3/4" Sqr Grate	Bl	1	1	\$249.72
861-6PI	6" Hub - 11-3/4" Sqr Grate	Bl	1	1	\$351.04

Supply

Drainage

Support

Specialties

Appendix

SquareMax™ Floor Sink Accessories

Item Number	Item Description	Pkg Type	Min Qty	Case Qty	Price
<b>STRAINERS</b>					
861-5	PVC Full Strainer w/ Lift Handle	BI	1	15	\$32.58
861-51	PVC Open-Half Strainer	BI	1	15	\$24.97
861-51AR		BI	1	10	\$75.00
861-51NR	Nikl-Brnz Ring & Open-Half Strainer	BI	1	3	\$530.00
861-51SR	Stnls Steel Ring & Open-Half Strainer	BI	1	3	\$437.53
861-53	PVC Open-Quarter Strainer	BI	1	15	\$28.96
861-53N	Nikl-Brnz Open-Quarter Strainer Only	BI	1	1	\$279.43
861-53NR	Nikl-Brnz Ring & Open-Quarter Strainer	BI	1	3	\$530.00
<b>861-53SR</b>	Stnls Steel Ring & Open-Quarter Strainer	BI	1	1	\$484.18
861-5AR	Adjustable PVC Frame with Full Strainer	BI	1	10	\$75.00
<b>861-5CI</b>	Heel-Proof, Ductile Iron Ring & Full Strainer	BI	1	3	\$189.56
861-5CIG	Heel-Proof, Ductile Iron Strainer Only	BI	1	1	\$113.74
861-5NR	Nikl-Brnz Ring & Full Strainer	BI	1	3	\$530.00
<b>861-5SR</b>	Stnls Steel Ring & Full Strainer	BI	1	1	\$530.80
<b>ACCESSORIES</b>					
861-6	Flat Secondary Strainer - White ABS	BI	1	10	\$11.58
861-C	PVC Clamping Collar w/ Stainless Steel Bolts	BI	1	5	\$18.93
861-D	Dome Bottom Strainer - White ABS	BI	1	80	\$9.42
861-UM	Stainless Steel Debris Basket	BI	1	5	\$60.67
863-FA	Round Aluminum Condensate Funnel w/ Screws	BI	1	12	\$49.15
863-FN	Round Nikl-Brnz Condensate Funnel w/ Screws	BI	1	12	\$109.99
863-FNO	Oval Nikl-Brnz Condensate Funnel w/ Screws	BI	1	12	\$243.96
863-U	Aluminum Dome Bottom Strainer (Not For 6" Conn.)	BI	1	5	\$21.73



861-5

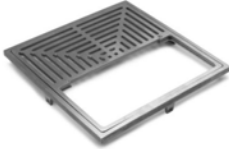

861-51NR

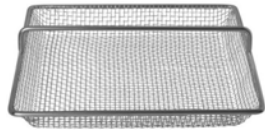

861-UM



863-FNO



863-U

Supply

Drainage

Support

Specialties

Appendix

**PVC - Sch. 40 Hub Connection**

**Floor Sinks**

**Options:** Add suffix to item no. Add price to list

**S** = ABS Sand Bucket: \$14.00; **U** = ABS Debris Bucket: \$14.00;

**C** = ABS Clamping Collar: \$17.00; **D** = ABS Dome Bottom Strainer: \$10.00;

**V** = Vandal-Resistant Strainer (1): \$12.00; **T** = Tapped Trap Primer Connection - 1/2" FIP: \$12.00;

**2** = Open-Half Strainer (1): N/C; **3** = Open-Quarter Strainer (2): N/C;

**W** = Stainless Steel Debris Basket: \$52.00; **F** = Round Nickel-Bronze Condensate Funnel: \$108.00;

**FA** = Round Aluminum Condensate Funnel: \$48.00; **FO** = Oval Nickel-Bronze Condensate Funnel: \$238.00;

**J** = Solid (gray) PVC Cover with Lift Handle (3): \$45.00; **6** = ABS Flat Strainer for Drain Outlet: \$12.00;

**L** = Aluminum Dome Bottom Strainer: \$22.00;

1: Not available for iron strainers 2: For PVC Strainers Only 3: For sinks with NO strainer only



860-W2P



860-W2PN

Item Number	Item Description	Pkg Type	Min Qty	Case Qty	Price
<b>SINK ONLY - NO STRAINER</b>					
860-W2PX	2" White PVC Hub - 9" Rnd Grate	Bl	1	4	\$53.20
860-W3PX	3" White PVC Hub - 9" Rnd Grate	Bl	1	4	\$53.20
860-W4PX	4" White PVC Hub - 9" Rnd Grate	Bl	1	4	\$53.20
<b>PVC STRAINER</b>					
860-W2P	2" White PVC Hub - 9" Rnd Grate	Bl	1	4	\$83.25
860-W3P	3" White PVC Hub - 9" Rnd Grate	Bl	1	4	\$83.25
860-W4P	4" White PVC Hub - 9" Rnd Grate	Bl	1	4	\$83.25
<b>NICKEL-BRONZE RING &amp; STRAINER</b>					
860-W2PN	2" White PVC Hub - 9-3/4" Rnd Grate	Bl	1	1	\$343.80
860-W3PN	3" White PVC Hub - 9-3/4" Rnd Grate	Bl	1	4	\$343.80
860-W4PN	4" White PVC Hub - 9-3/4" Rnd Grate	Bl	1	4	\$343.80
<b>STAINLESS STEEL RING &amp; STRAINER</b>					
860-W2PZ	2" White PVC Hub - 9-3/4" Rnd Grate	Bl	1	1	\$343.80
860-W3PZ	3" White PVC Hub - 9-3/4" Rnd Grate	Bl	1	1	\$343.80
860-W4PZ	4" White PVC Hub - 9-3/4" Rnd Grate	Bl	1	4	\$343.80
<b>DUCTILE IRON RING &amp; STRAINER</b>					
860-W2PI	2" White PVC Hub - 9-7/8" Rnd Grate	Bl	1	1	\$148.39
860-W3PI	3" White PVC Hub - 9-7/8" Rnd Grate	Bl	1	2	\$148.39
860-W4PI	4" White PVC Hub - 9-7/8" Rnd Grate	Bl	1	2	\$148.39

Supply

Drainage

Support

Specialties

Appendix

**FatMax™ Floor Sink Accessories**

Item Number	Item Description	Pkg Type	Min Qty	Case Qty	Price
<b>STRAINERS</b>					
860-GI	Cast Iron Full Strainer Only	BI	1	5	\$87.22
<b>860-GN</b>	Nckl-Brnz Full Strainer Only	BI	1	1	\$207.41
<b>860-GN2</b>	Nickl-Brnz Open-Half Strainer Only	BI	1	1	\$147.86
<b>860-GN3</b>	Nickl-Brnz Open-Quarter Strainer Only	BI	1	1	\$173.28
<b>860-RGN</b>	Nckl-Brnz Ring And Full Strainer	BI	1	1	\$305.00
860-RGN2	Nickl-Brnz Ring And Open-Half Strainer	BI	1	1	\$305.00
860-RGS	304 Stnls Steel Ring And Full Strainer	BI	1	1	\$305.00
860-RGS2	304 Stnls Steel Ring And Open-Half Strainer	BI	1	1	\$305.00
<b>860-WGP</b>	PVC Full Strainer w/ Lift Handle	BI	1	16	\$36.19
860-WGP2	PVC Open-Half Strainer	BI	1	10	\$28.96
860-WGP3	PVC Open-Quarter Strainer	BI	1	10	\$33.29
<b>860-WGPJ</b>	PVC Full Cover	BI	1	16	\$43.43
<b>ACCESSORIES</b>					
860-C	Clamping Collar w/ Screws - Gray ABS	BI	1	10	\$14.85
860-UM	Stainless Steel Debris Basket	BI	1	5	\$53.08
<b>860-WS</b>	Sand Bucket For Sump Area - White PVC	BI	1	20	\$14.10
<b>860-WU</b>	Debris Bucket For Sump Area - White PVC	BI	1	20	\$14.10
861-6	Flat Secondary Strainer - White ABS	BI	1	10	\$11.58
861-D	Dome Bottom Strainer - White ABS	BI	1	80	\$9.42
863-FA	Round Aluminum Condensate Funnel w/ Screws	BI	1	12	\$49.15
863-FN	Round Nikl-Brnz Condensate Funnel w/ Screws	BI	1	12	\$109.99
863-FNO	Oval Nikl-Brnz Condensate Funnel w/ Screws	BI	1	12	\$243.96
863-U	Aluminum Dome Bottom Strainer (Not For 6" Conn.)	BI	1	5	\$21.73

Supply

Drainage

Support

Specialties

Appendix



860-WGP2



860-RGS



860-C



860-WS



860-WU



861-D

**PVC - Sch. 40 Hub Connection**

**Options:** Add suffix to item no. Add price to list

**V** = Vandal-Resistant Strainer: \$12.00; **T** = Tapped Trap Primer Connection - 1/2" FIP: \$8.00;

**S** = Sand Bucket: \$12.00; **U** = Stainless Steel Debris Basket for Sump Area: \$41.00;

**2** = Open-Half Strainer: \$20.00; **3** = Open-Quarter Strainer: \$20.00;

**X** = Less Strainer: N/C;

Item Number	Item Description	Pkg Type	Min Qty	Case Qty	Price
<b>FLOOR SINKS</b>					
864-W2P	2" Hub - 6-5/8" Rnd PVC Grate	BI	1	3	\$55.15
864-W3P	3" Hub - 6-5/8" Rnd PVC Grate	BI	1	3	\$55.15
<b>864-W4P</b>	4" Hub - 6-5/8" Rnd PVC Grate	BI	1	3	\$55.15
<b>ACCESSORIES</b>					
863-FA	Round Aluminum Condensate Funnel w/ Screws	BI	1	12	\$49.15
863-FN	Round Nikl-Brnz Condensate Funnel w/ Screws	BI	1	12	\$109.99
863-FNO	Oval Nikl-Brnz Condensate Funnel w/ Screws	BI	1	12	\$243.96
864-UM	Stainless Steel Mesh Debris Basket	BI	1	10	\$41.36
864-WGP	PVC Strainer w/ Lift Handle, Loose Set	BI	1	1	\$19.99
<b>864-WGP2</b>	Open-Half PVC Strainer, Loose Set	BI	1	1	\$39.99
864-WS	PVC Sand Bucket (Fits Inside Sump Area)	BI	1	10	\$12.41



864-W2P

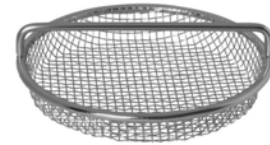

864-UM

Supply

Drainage

Support

Specialties

Appendix



# Commercial Roof Drains

**Roof Drains**

**Planter Area Drains**







# 11" Roof Drain

## PVC/ABS - Sch. 40 Hub Connection

**Options:** Add suffix to item no. Add price to list

- V = Vandal-Resistant Dome: \$12.00; W = 2-3/16" High External Water Dam: \$125.00;
- P = Steel Screen Installed over Dome Strainer: \$75.00; STP2 = 2" High Internal Water Dam: \$100.00;
- U = Underdeck Clamp Kit: \$85.00; S = Sump Receiver: \$67.00;
- E = Extension Collar Kit: \$78.00;



868-P3

Item Number	Item Description	Pkg Type	Min Qty	Case Qty	Price
<b>ROOF DRAINS WITH POLY DOME STRAINER</b>					
868-A3	3" ABS Hub	Bl	1	2	\$129.64
<b>868-A4</b>	4" ABS Hub	Bl	1	2	\$129.64
<b>868-A6</b>	6" ABS Hub	Bl	1	2	\$142.29
868-P3	3" PVC Hub	Bl	1	2	\$129.64
868-P4	4" PVC Hub	Bl	1	2	\$129.64
868-P6	6" PVC Hub	Bl	1	2	\$142.29
<b>ROOF DRAINS WITH ALUMINUM DOME STRAINER</b>					
<b>868-A3M</b>	3" ABS Hub	Bl	1	2	\$189.58
<b>868-A4M</b>	4" ABS Hub	Bl	1	2	\$189.58
<b>868-A6M</b>	6" ABS Hub	Bl	1	2	\$202.24
868-P3M	3" PVC Hub	Bl	1	2	\$189.58
868-P4M	4" PVC Hub	Bl	1	2	\$189.58
868-P6M	6" PVC Hub	Bl	1	2	\$202.24
<b>ACCESSORIES</b>					
868-C	Under Deck Clamp Kit: 11" Epoxy-Coated Clamping Plate, Thread Rod, Nuts & Washers	Bl	1	5	\$86.00
868-E	Extension Collar Kit: 13" Extension Collar, Thread Rod, Nuts & Washers	Bl	1	5	\$78.50
868-HD	9-1/4" Diameter, Polyethylene	Bl	1	5	\$26.04
868-MC	Epoxy-Coated Aluminum Replacement Gravel Guard	Bl	1	10	\$97.10
868-MD	Dome Strainer - 9-1/4" Diameter, Cast Aluminum	Bl	1	5	\$94.61
868-S	Sump Receiver: 11-1/2" Sump Receiver Plate	Bl	1	10	\$67.58
868-WD	Epoxy-Coated Aluminum External Water Dam, 2-3/16"	Bl	1	1	\$132.88

Supply

Drainage

Support

Specialties

Appendix



867-P2

## 10" Roof Drain

### PVC/ABS - Sch. 40 Hub Connection

**Options:** Add suffix to item no. Add price to list

**V** = Vandal-Resistant Dome: \$12.00; **P** = Steel Screen Installed over Dome Strainer: \$75.00;

**C** = Ductile Iron Gravel Guard (1): \$35.00; **STP2** = 2" High Internal Water Dam: \$75.00;

**U** = Underdeck Clamp Kit: \$38.00;

1: In lieu of PVC (standard)

Item Number	Item Description	Pkg Type	Min Qty	Case Qty	Price
<b>ROOF DRAINS WITH POLY DOME STRAINER</b>					
<b>867-A2</b>	2" ABS Hub	BI	2	2	\$60.92
867-A3	3" ABS Hub	BI	2	2	\$60.92
867-A4	4" ABS Hub	BI	2	2	\$60.92
867-P2	2" PVC Hub	BI	2	2	\$60.92
867-P3	3" PVC Hub	BI	2	2	\$60.92
867-P4	4" PVC Hub	BI	2	2	\$60.92
<b>ROOF DRAINS WITH CAST IRON DOME STRAINER</b>					
<b>867-A2M</b>	2" ABS Hub	BI	2	2	\$89.59
<b>867-A3M</b>	3" ABS Hub	BI	2	2	\$89.59
<b>867-A4M</b>	4" ABS Hub	BI	2	2	\$89.59
<b>867-P2M</b>	2" PVC Hub	BI	2	2	\$89.59
867-P3M	3" PVC Hub	BI	2	2	\$89.59
867-P4M	4" PVC Hub	BI	2	2	\$89.59
<b>ACCESSORIES</b>					
867-C	Underdeck Clamp Kit	BI	1	25	\$38.00
867-HC	PVC Replacement Gravel Guard	BI	1	5	\$16.49
867-HD	7-1/2" Diameter, Polypro Dome	BI	1	5	\$15.06
867-MC	Ductile Iron Replacement Gravel Guard	BI	1	1	\$33.72
867-MD	7-1/2" Diameter, Cast Iron Dome	BI	1	5	\$52.46
867-UM	Stainless Steel Dome Screen	BI	1	1	\$75.09

## 8" Roof Drain & Overflow - Cast Iron Dome

### Cast Iron - No-Hub Connection

Item Number	Item Description	Pkg Type	Min Qty	Case Qty	Price
867-DI2	2" No-Hub Roof Drain & Overflow Combo	BI	1	1	\$140.30
867-DI3	3" No-Hub Roof Drain & Overflow Combo	BI	1	1	\$140.30
867-DI4	4" No-Hub Roof Drain & Overflow Combo	BI	1	1	\$140.30



867-DI2

Supply

Drainage

Support

Specialties

Appendix

**PVC/ABS - Sch. 40 Hub Connection**

Item Number	Item Description	Pkg Type	Min Qty	Case Qty	Price
<b>PLANTER-AREA DRAINS</b>					
867-L3AP	3" ABS Hub, Poly Dome Strainer w/ SS Screen	BI	1	1	\$164.86
867-L3PP	3" PVC Hub, Poly Dome Strainer w/ SS Screen	BI	1	1	\$164.86
<b>867-L4AP</b>	4" ABS Hub, Poly Dome Strainer w/ SS Screen	BI	1	1	\$164.86
867-L4PP	4" PVC Hub, Poly Dome Strainer w/ SS Screen	BI	1	1	\$164.86
<b>ACCESSORIES</b>					
867-C	Underdeck Clamp Kit	BI	1	25	\$38.00
867-HC	PVC Replacement Gravel Guard	BI	1	5	\$16.49
867-MC	Ductile Iron Replacement Gravel Guard	BI	1	1	\$33.72
867-UM	Stainless Steel Dome Screen	BI	1	1	\$75.09



867-L3PP



867-C

Supply

Drainage

Support

Specialties

Appendix

# Commercial Cleanouts

**FinishLine™ Adjustable Cleanouts**

**Access Cover Cleanouts**

**Halo™ Cleanouts**

**Wall Cleanouts**

**Cleanout Bushing**

**Plugs/Accessories**

FinishLine™ Cleanouts are adjustable both before and AFTER the concrete pour.



The FinishLine virtually eliminates cleanouts set too low or not level. Installations are faster, easier, and more professional looking.



**834-4PNQ**  
Page 359



**852-4PI**  
Page 360



**852-3LNQ**  
Page 360



**822-C3PSR**  
Page 362



**822-CF3PNR**  
Page 363



**851-44N**  
Page 364

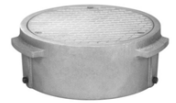

**850-3T**  
Page 365



**870-3**  
Page 366



**871-4**  
Page 366



**873-240**  
Page 367



**875-3P**  
Page 369



**875-84PN**  
Page 369



**878-20**  
Page 370



**878-S30**  
Page 371



**876-30**  
Page



**852-CN3**  
Page 372

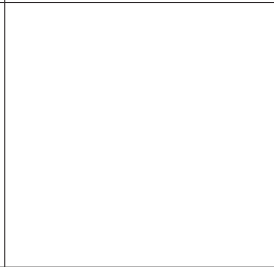
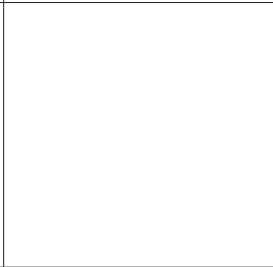
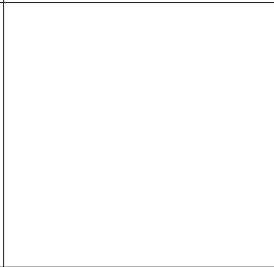
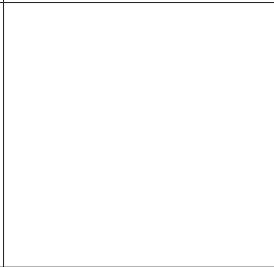
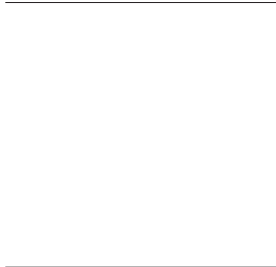
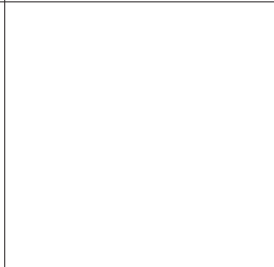
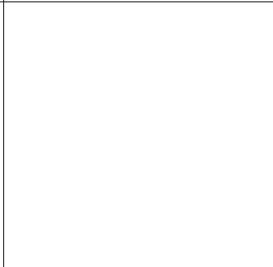
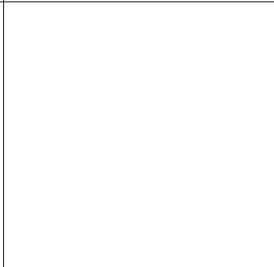
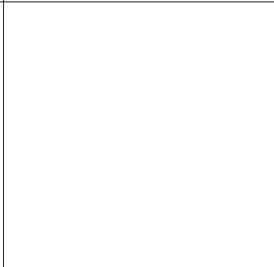

**PVC/ABS - Sch. 40 Hub Connection**

**6-1/2" Tops**

**Options:** Add suffix to item no. Add price to list

**V** = Vandal-Resistant Cover: \$6.50; **S** = Stamping: Specify Letters: \$12.50;

**C** = Carpet Marker: \$16.00; **B** = Brass Cleanout Plug (1): \$12.00;

**Z** = Complies with Buy American Act (2): \$62.00;

1: In lieu of polypro (standard) 2: For round nickel-bronze ring/cover only



834-4AF



834-3PNQ

Item Number	Item Description	Pkg Type	Min Qty	Case Qty	Price
<b>ROUGH-IN FIXTURE</b>					
834-3AF	3" ABS Hub	Bl	1	10	\$27.47
834-3PF	3" PVC Hub	Bl	1	10	\$27.47
834-4AF	4" ABS Hub	Bl	1	10	\$28.78
834-4PF	4" PVC Hub	Bl	1	10	\$27.47
<b>FINISH FIXTURE</b>					
834-4HNQ	6-5/8" Sqr Nikl-Brnz Ring & Strainer	Bl	1	10	\$106.73
834-4HNR	6-1/2" Rnd Nikl-Brnz Ring & Strainer	Bl	1	10	\$81.77
<b>834-4HSQ</b>	6-5/8" Sqr Stnls Steel Ring & Strainer	Bl	1	10	\$106.73
834-4HSR	6-1/2" Rnd Stnls Steel Ring & Strainer	Bl	1	10	\$81.77
<b>COMPLETE ASSEMBLY</b>					
<b>834-3ANQ</b>	3" Hub - 6-5/8" Sqr Nikl-Brnz Ring & Strainer	Bl	1	1	\$134.16
834-3ANR	3" Hub - 6-1/2" Rnd Nikl-Brnz Ring & Strainer	Bl	1	1	\$109.20
<b>834-3ASQ</b>	3" Hub - 6-5/8" Sqr Stnls Steel Ring & Strainer	Bl	1	1	\$134.16
<b>834-3ASR</b>	3" Hub - 6-1/2" Rnd Stnls Steel Ring & Strainer	Bl	1	1	\$109.20
834-3PNQ	3" Hub - 6-5/8" Sqr Nikl-Brnz Ring & Strainer	Bl	1	1	\$134.16
834-3PNR	3" Hub - 6-1/2" Rnd Nikl-Brnz Ring & Strainer	Bl	1	1	\$109.20
834-3PSQ	3" Hub - 6-5/8" Sqr Stnls Steel Ring & Strainer	Bl	1	1	\$134.16
834-3PSR	3" Hub - 6-1/2" Rnd Stnls Steel Ring & Strainer	Bl	1	1	\$109.20
834-4ANQ	4" Hub - 6-5/8" Sqr Nikl-Brnz Ring & Strainer	Bl	1	1	\$134.16
834-4ANR	4" Hub - 6-1/2" Rnd Nikl-Brnz Ring & Strainer	Bl	1	1	\$109.20
<b>834-4ASQ</b>	4" Hub - 6-5/8" Sqr Stnls Steel Ring & Strainer	Bl	1	1	\$134.16
<b>834-4ASR</b>	4" Hub - 6-1/2" Rnd Stnls Steel Ring & Strainer	Bl	1	1	\$109.20
834-4PNQ	4" Hub - 6-5/8" Sqr Nikl-Brnz Ring & Strainer	Bl	1	1	\$134.16
834-4PNR	4" Hub - 6-1/2" Rnd Nikl-Brnz Ring & Strainer	Bl	1	1	\$109.20
<b>834-4PSQ</b>	4" Hub - 6-5/8" Sqr Stnls Steel Ring & Strainer	Bl	1	1	\$134.16
834-4PSR	4" Hub - 6-1/2" Rnd Stnls Steel Ring & Strainer	Bl	1	1	\$109.20
<b>ACCESSORIES</b>					
832-EX4	Ductile Iron Extension Adapter - 2" Min - 4" Max	Bl	1	1	\$34.14
832-S4	Two Adjustment Shims, Two 3/4" Screws	Bl	1	10	\$6.10
832-W	Flexible Red Locating Bristles w/ Screw	Bl	1	10	\$7.26

Supply

Drainage

Support

Specialties

Appendix



852-3ANR



852-3PSQ



852-4PI

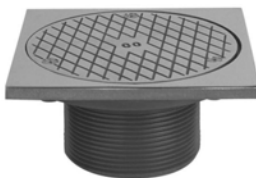

852-3LNQ

## PVC/ABS - Sch. 40 Hub Connection

**Options:** Add suffix to item no. Add price to list

**V** = Vandal-Resistant Cover: \$6.50; **S** = Stamping: Specify Letters (1): \$12.50;

**Z** = Complies with Buy American Act (2): \$62.00; **C** = Carpet Marker: \$16.00;

**H** = Special-Duty Cover (15,000 lbs. safe load) (3): \$39.75; **Y** = Ductile Iron Head Adapter (4): \$26.00;

1: Not available for iron covers. 2: For round nickel-bronze ring/cover only 3: Not available for stainless steel covers 4: In lieu of ABS (standard)

Item Number	Item Description	Pkg Type	Min Qty	Case Qty	Price
<b>NICKEL-BRONZE RING &amp; COVER</b>					
<b>852-3ANQ</b>	3" ABS Hub - 6-5/8" Sqr Ring & Cover	BI	1	1	\$139.99
<b>852-3ANR</b>	3" ABS Hub - 6-1/2" Rnd Ring & Cover	BI	1	5	\$109.88
<b>852-3PNQ</b>	3" PVC Hub - 6-5/8" Sqr Ring & Cover	BI	1	2	\$139.99
<b>852-3PNR</b>	3" PVC Hub - 6-1/2" Rnd Ring & Cover	BI	1	5	\$109.88
<b>852-4ANQ</b>	4" ABS Hub - 6-5/8" Sqr Ring & Cover	BI	1	1	\$139.99
<b>852-4ANR</b>	4" ABS Hub - 6-1/2" Rnd Ring & Cover	BI	1	10	\$109.88
<b>852-4PNQ</b>	4" PVC Hub - 6-5/8" Sqr Ring & Cover	BI	1	2	\$139.99
<b>852-4PNR</b>	4" PVC Hub - 6-1/2" Rnd Ring & Cover	BI	1	10	\$109.88
<b>STAINLESS STEEL RING &amp; COVER</b>					
<b>852-3ASQ</b>	3" ABS Hub - 6-5/8" Sqr Ring & Cover	BI	1	1	\$139.99
<b>852-3ASR</b>	3" ABS Hub - 6-1/2" Rnd Ring & Cover	BI	1	5	\$109.88
<b>852-3PSQ</b>	3" PVC Hub - 6-5/8" Sqr Ring & Cover	BI	1	1	\$139.99
<b>852-3PSR</b>	3" PVC Hub - 6-1/2" Rnd Ring & Cover	BI	1	1	\$109.88
<b>852-4ASQ</b>	4" ABS Hub - 6-5/8" Sqr Ring & Cover	BI	1	1	\$139.99
<b>852-4ASR</b>	4" ABS Hub - 6-1/2" Rnd Ring & Cover	BI	1	1	\$109.88
<b>852-4PSQ</b>	4" PVC Hub - 6-5/8" Sqr Ring & Cover	BI	1	2	\$139.99
<b>852-4PSR</b>	4" PVC Hub - 6-1/2" Rnd Ring & Cover	BI	1	10	\$109.88
<b>CAST IRON RING &amp; COVER</b>					
<b>852-3AI</b>	3" ABS Hub - 6-1/2" Rnd Ring & Cover	BI	1	1	\$64.72
<b>852-3PI</b>	3" PVC Hub - 6-1/2" Rnd Ring & Cover	BI	1	2	\$64.72
<b>852-4AI</b>	4" ABS Hub - 6-1/2" Rnd Ring & Cover	BI	1	1	\$64.72
<b>852-4PI</b>	4" PVC Hub - 6-1/2" Rnd Ring & Cover	BI	1	2	\$64.72

## ABS - MIP Thread Connection

**Options:** Add suffix to item no. Add price to list

**V** = Vandal-Resistant Cover: \$6.50; **S** = Stamping: Specify Letters (1): \$12.50;

1: Not available for iron covers.

Item Number	Item Description	Pkg Type	Min Qty	Case Qty	Price
<b>NICKEL-BRONZE RING &amp; COVER</b>					
<b>852-2LNR</b>	2" ABS MIP - 4-1/2" Rnd Ring & Cover	BI	1	10	\$63.97
<b>852-3LNQ</b>	3" ABS MIP - 5-7/8" Sqr Ring & Cover	BI	1	5	\$116.66
<b>852-3LNR</b>	3" ABS MIP - 5-1/2" Rnd Ring & Cover	BI	1	10	\$79.01
<b>852-4LNQ</b>	4" ABS MIP - 6-5/8" Sqr Ring & Cover	BI	1	1	\$139.24
<b>852-4LNR</b>	4" ABS MIP - 6-1/2" Rnd Ring & Cover	BI	1	10	\$109.15
<b>852-4LNRPK</b>	4" ABS MIP - 6-1/2" Rnd Ring & Cover	CI	5	5	\$110.15



**ABS - MIP Thread Connection (Cont)**

Item Number	Item Description	Pkg Type	Min Qty	Case Qty	Price
<b>STAINLESS STEEL RING &amp; COVER</b>					
852-3LSQ	3" ABS MIP - 5-7/8" Sqr Ring & Cover	Bl	1	1	\$116.66
852-3LSR	3" ABS MIP - 5-1/2" Rnd Ring & Cover	Bl	1	10	\$79.01
852-4LSQ	4" ABS MIP - 6-5/8" Sqr Ring & Cover	Bl	1	1	\$139.24
852-4LSR	4" ABS MIP - 6-1/2" Rnd Ring & Cover	Bl	1	1	\$109.15
<b>CAST IRON RING &amp; COVER</b>					
852-3LI	3" ABS MIP - 6-1/8" Rnd Ring & Cover	Bl	1	2	\$56.45
852-4LI	4" ABS MIP - 6-1/2" Rnd Ring & Cover	Bl	1	2	\$55.38
<b>GRAY ABS COVER</b>					
852-3LP	3" ABS MIP - 5-1/2" Rnd Ring & Cover	Bl	1	10	\$33.89
852-4LP	4" ABS MIP - 6-1/2" Rnd Ring & Cover	Bl	1	1	\$33.89



852-3LSR



852-3LI



852-3LP

Supply

Drainage

Support

Specialties

Appendix



822-C3ANR



822-C3ASR

## Halo™ Adjustable Cleanouts

### PVC/ABS - Sch. 40 Hub Connection

**Options:** Add suffix to item no. Add price to list

**V** = Vandal-Resistant Cover: \$6.50; **S** = Stamping: Specify Letters: \$12.50;

**C** = Carpet Marker: \$16.00; **Z** = Complies with Buy American Act (1): \$62.00;

1: For round nickel-bronze ring/cover only

Item Number	Item Description	Pkg Type	Min Qty	Case Qty	Price
<b>NICKEL-BRONZE RING &amp; COVER</b>					
822-C3ANQ	3" ABS Hub - 5-7/8" Sqr Ring & Cover	BI	1	1	\$126.99
822-C3ANR	3" ABS Hub - 5-1/2" Rnd Ring & Cover	BI	1	1	\$93.56
822-C3PNQ	3" PVC Hub - 5-7/8" Sqr Ring & Cover	BI	1	1	\$126.99
822-C3PNR	3" PVC Hub - 5-1/2" Rnd Ring & Cover	BI	1	4	\$93.56
822-C4ANQ	Inside 4" ABS - 5-7/8" Sqr Ring & Cover	BI	1	1	\$150.39
822-C4ANR	Inside 4" ABS - 5-1/2" Rnd Ring & Cover	BI	1	1	\$116.97
822-C4PNQ	Inside 4" PVC - 5-7/8" Sqr Ring & Cover	BI	1	1	\$150.39
822-C4PNR	Inside 4" PVC - 5-1/2" Rnd Ring & Cover	BI	1	1	\$116.97
<b>STAINLESS STEEL RING &amp; COVER</b>					
822-C3ASQ	3" ABS Hub - 5-7/8" Sqr Ring & Cover	BI	1	1	\$126.99
822-C3ASR	3" ABS Hub - 5-1/2" Rnd Ring & Cover	BI	1	1	\$93.56
822-C3PSQ	3" PVC Hub - 5-7/8" Sqr Ring & Cover	BI	1	1	\$126.99
822-C3PSR	3" PVC Hub - 5-1/2" Rnd Ring & Cover	BI	1	4	\$93.56
822-C4ASQ	Inside 4" ABS - 5-7/8" Sqr Ring & Cover	BI	1	1	\$150.39
822-C4ASR	Inside 4" ABS - 5-1/2" Rnd Ring & Cover	BI	1	1	\$116.97
822-C4PSQ	Inside 4" PVC - 5-7/8" Sqr Ring & Cover	BI	1	1	\$150.39
822-C4PSR	Inside 4" PVC - 5-1/2" Rnd Ring & Cover	BI	1	4	\$116.97
<b>ACCESSORIES</b>					
822-EX3	Ductile Iron Extension Adapter	B	1	1	\$35.33

## FinishLine Halo™ Adjustable Cleanouts

### PVC/ABS - Sch. 40 Hub Connection

**Options:** Add suffix to item no. Add price to list

**V** = Vandal-Resistant Cover: \$6.50; **S** = Stamping: Specify Letters: \$12.50;

**C** = Carpet Marker: \$16.00; **Z** = Complies with Buy American Act (1): \$62.00;

1: For round nickel-bronze ring/cover only



822-C3PF



834-3HSQ

Item Number	Item Description	Pkg Type	Min Qty	Case Qty	Price
<b>ROUGH-IN FIXTURE</b>					
822-C3AF	3" ABS Hub	BI	1	1	\$57.49
822-C3PF	3" PVC Hub	BI	1	1	\$57.49
<b>FINISH FIXTURE</b>					
834-3HNQ	5-7/8" Sqr Nikl-Brnz Ring & Strainer	BI	1	1	\$89.88
834-3HNR	5-1/2" Rnd Nikl-Brnz Ring & Strainer	BI	1	10	\$58.65
834-3HSQ	5-7/8" Sqr Stnls Steel Ring & Strainer	BI	1	1	\$89.88
834-3HSR	5-1/2" Rnd Stnls Steel Ring & Strainer	BI	1	1	\$58.65

## FinishLine Halo™ Adjustable Cleanouts (Cont)

### PVC/ABS - Sch. 40 Hub Connection

Item Number	Item Description	Pkg Type	Min Qty	Case Qty	Price
<b>COMPLETE ASSEMBLY</b>					
822-CF3ANQ	3" ABS Hub - 5-7/8" Sqr Nikl-Brnz Ring & Cover	Bl	1	1	\$153.75
822-CF3ANR	3" ABS Hub - 5-1/2" Rnd Nikl-Brnz Ring & Cover	Bl	1	1	\$120.30
822-CF3ASQ	3" ABS Hub - 5-7/8" Sqr Stnls Steel Ring & Cover	Bl	1	1	\$153.75
822-CF3ASR	3" ABS Hub - 5-1/2" Rnd Stnls Steel Ring & Cover	Bl	1	1	\$120.30
822-CF3PNQ	3" PVC Hub - 5-7/8" Sqr Nikl-Brnz Ring & Cover	Bl	1	1	\$153.75
822-CF3PNR	3" PVC Hub - 5-1/2" Rnd Nikl-Brnz Ring & Cover	Bl	1	1	\$120.30
822-CF3PSQ	3" PVC Hub - 5-7/8" Sqr Stnls Steel Ring & Cover	Bl	1	1	\$153.75
822-CF3PSR	3" PVC Hub - 5-1/2" Rnd Stnls Steel Ring & Cover	Bl	1	1	\$120.30
<b>ACCESSORIES</b>					
822-EX3	Ductile Iron Extension Adapter	B	1	1	\$35.33
832-EX3	Ductile Iron Extension Adapter - 2" Min - 3-3/8" Max	Bl	1	1	\$34.14
832-S3	Two Adjustment Shims, Two 3/4" Screws	Bl	1	10	\$6.10
832-W	Flexible Red Locating Bristles w/ Screw	Bl	1	10	\$7.26



822-CF3PNR

Supply

Drainage

Support

Specialties

Appendix

Supply

Drainage

Support

Specialties

Appendix



851-44N



851-34I

## PVC/ABS - Sch. 40 Hub Connection

**Options:** Add suffix to item no. Add price to list

**V** = Vandal-Resistant Cover: \$6.50; **S** = Stamping: Specify Letters (1): \$12.50;

**C** = Carpet Marker (1): \$16.00;

1: Not available for iron covers.

Item Number	Item Description	Pkg Type	Min Qty	Case Qty	Price
<b>NICKEL-BRONZE COVER</b>					
<b>851-33N</b>	3" ABS Hub - 4-3/8" Rnd Ring & Cover	BI	1	2	\$139.47
851-34N	4" ABS Hub - 6" Rnd Ring & Cover	BI	1	2	\$176.17
<b>851-36N</b>	6" ABS Hub - 8-3/8" Rnd Ring & Cover	BI	1	2	\$326.65
<b>851-43N</b>	3" PVC Hub - 4-3/8" Rnd Ring & Cover	BI	1	2	\$139.47
851-44N	4" PVC Hub - 6" Rnd Ring & Cover	BI	1	2	\$176.17
851-46N	6" PVC Hub - 8-3/8" Rnd Ring & Cover	BI	1	2	\$326.65
<b>TENZ-ALLOY COVER</b>					
<b>851-33T</b>	3" ABS Hub - 4-3/8" Rnd Ring & Cover	BI	1	2	\$185.74
<b>851-34T</b>	4" ABS Hub - 6" Rnd Ring & Cover	BI	1	2	\$100.39
<b>851-36T</b>	6" ABS Hub - 8-3/8" Rnd Ring & Cover	BI	1	2	\$172.08
851-43T	3" PVC Hub - 4-3/8" Rnd Ring & Cover	BI	1	2	\$185.74
851-44T	4" PVC Hub - 6" Rnd Ring & Cover	BI	1	2	\$100.39
851-46T	6" PVC Hub - 8-3/8" Rnd Ring & Cover	BI	1	2	\$172.08
<b>CAST IRON COVER</b>					
851-34I	4" ABS Hub - 6" Rnd Ring & Cover	BI	1	2	\$86.19
<b>851-36I</b>	6" ABS Hub - 8-1/2" Rnd Ring & Cover	BI	1	2	\$176.15
851-44I	4" PVC Hub - 6" Rnd Ring & Cover	BI	1	2	\$86.19
851-46I	6" PVC Hub - 8-1/2" Rnd Ring & Cover	BI	1	2	\$176.15
<b>NB LAMINATED CAST IRON COVER</b>					
<b>851-36IN</b>	6" ABS Hub - 7-1/8" Rnd Ring & Cover	BI	1	2	\$326.65
<b>851-46IN</b>	6" PVC Hub - 7-1/8" Rnd Ring & Cover	BI	1	2	\$326.65

**Set Screw Connection**

**Options:** Add suffix to item no. Add price to list  
**V** = Vandal-Resistant Cover: \$6.50; **S** = Stamping: Specify Letters (1): \$12.50;  
 1: Not available for iron covers

Item Number	Item Description	Pkg Type	Min Qty	Case Qty	Price
<b>NICKEL-BRONZE</b>					
850-234N	5-1/2" Cover - Over 2", 3", Or 4" Pipe	Bl	1	10	\$101.79
850-2N	6-1/2" Cover - Over 2" Pipe	Bl	1	6	\$227.16
850-3N	7-1/8" Cover - Over 3" Pipe	Bl	1	6	\$336.59
<b>850-4N</b>	9-1/8" Cover - Over 4" Pipe	Bl	1	6	\$446.02
<b>TENZ-ALLOY</b>					
850-2T	6-1/2" Cover - Over 2" Pipe	Bl	1	6	\$90.69
850-3T	7-1/8" Cover - Over 3" Pipe	Bl	1	6	\$115.30
850-4T	9-1/8" Cover - Over 4" Pipe	Bl	1	6	\$172.64
<b>CAST IRON</b>					
<b>850-2I</b>	6" Cover - Over 2" Pipe	Bl	1	6	\$77.60
850-3I	7-1/8" Cover - Over 3" Pipe	Bl	1	4	\$90.37
850-4I	8-1/2" Cover - Over 4" Pipe	Bl	1	2	\$121.54
<b>NIKL-BRNZ LAMINATED CAST IRON</b>					
850-4IN	8-3/4" Cover - Over 4" Pipe	Bl	1	2	\$492.96



850-234N



850-2T



850-2I

Supply

Drainage

Support

Specialties

Appendix

Supply

Drainage

Support

Specialties

Appendix



870-3

## Cleanout Covers

### Stainless Steel Covers

**Options:** Add suffix to item no. Add price to list  
**S** = Stamping: Specify Letters: \$12.50;

Item Number	Item Description	Pkg Type	Min Qty	Case Qty	Price
<b>20-GA COVER</b>					
870-3	3" Diameter	BI	25	25	\$5.31
870-4	4" Diameter	BI	25	25	\$6.71
870-5	5" Diameter	BI	25	25	\$9.79
870-6	6" Diameter	BI	25	25	\$10.12
870-8	8" Diameter	BI	10	10	\$12.85
870-810	10" Diameter	BI	5	5	\$22.90
870-812	12" Diameter	BI	5	5	\$32.09

## Cleanout Covers

### ABS Covers



871-4



871-18

Item Number	Item Description	Pkg Type	Min Qty	Case Qty	Price
<b>FLAT COVER</b>					
871-4	White - 4-1/2" Diameter	BI	25	25	\$3.45
871-6	White - 6-1/2" Diameter	BI	25	25	\$6.27
871-8	White - 8-1/2" Diameter	BI	1	10	\$9.86
872-4	Chrome-Plated - 4-1/4" Diameter	BI	25	25	\$10.10
872-6	Chrome-Plated - 7-1/4" Diameter	BI	25	25	\$14.46
872-8	Chrome-Plated - 9-1/4" Diameter	BI	10	10	\$19.18
<b>RAISED COVER</b>					
871-16	White - 7-1/4" Diameter x 1-1/4" Height	BI	25	25	\$15.80
871-18	White - 9-1/4" Diameter x 1-1/4" Height	BI	10	10	\$21.54
872-16	Chrome-Plated - 7-1/4" Diameter x 1-1/4" Height	BI	25	25	\$20.88
872-18	Chrome-Plated - 9-1/4" Diameter x 1-1/4" Height	BI	10	10	\$27.95

Cleanout Cover Kits

Stainless Steel Covers

Options: Add suffix to item no. Add price to list  
 V = Vandal-Resistant Cover Screw (1): \$6.50;

1: For 873 Series only

Item Number	Item Description	Pkg Type	Min Qty	Case Qty	Price
<b>20-GA COVER WITH SCREW</b>					
870-3PK1	3" Cover, 2-1/2" Screw	Bl	5	5	\$7.81
870-4PK1	4" Cover, 2-1/2" Screw	Bl	5	5	\$9.21
870-6PK1	6" Cover, 2-1/2" Screw	Cl	5	5	\$12.62
870-8PK1	8" Cover, 2-1/2" Screw	Bl	5	5	\$15.91
<b>20-GA COVER WITH SCREW AND POLYPRO PLUG</b>					
873-240P	4" Cover, 2" Plug, 2-1/2" Screw	Bl	1	10	\$13.92
873-350P	5" Cover, 3" Plug, 2-1/2" Screw	Bl	1	10	\$18.87
873-460P	6" Cover, 4" Plug, 2-1/2" Screw	Bl	1	10	\$23.18
<b>20-GA COVER WITH SCREW AND BRASS PLUG</b>					
873-240	4" Cover, 2" Plug, 2-1/2" Screw	Bl	1	10	\$18.16
873-350	5" Cover, 3" Plug, 2-1/2" Screw	Bl	1	10	\$26.64
873-460	6" Cover, 4" Plug, 2-1/2" Screw	Bl	1	10	\$34.11
<b>20-GA COVER WITH SCREW AND WALL BAR</b>					
870-B3	3" Cover, 6" Screw, 9" Wall Bar	Bl	1	10	\$12.31
870-B4	4" Cover, 6" Screw, 9" Wall Bar	Bl	1	10	\$13.06
870-B5	5" Cover, 6" Screw, 9" Wall Bar	Bl	1	10	\$18.28
870-B6	6" Cover, 6" Screw, 9" Wall Bar	Bl	1	10	\$20.50
870-B8	8" Cover, 6" Screw, 9" Wall Bar	Bl	1	10	\$24.98

Cleanout Cover Accessories

Item Number	Item Description	Pkg Type	Min Qty	Case Qty	Price
<b>THREADED WALL BAR</b>					
870-B	1/4" x 20 Threaded Wall Bar, 9" Length	B	25	100	\$3.97
<b>CARPET MARKER KIT</b>					
870-2CM	Stainless Steel Carpet Marker w/ 1-1/2" Screw	Bl	25	25	\$4.39



870-6PK1



873-350



870-B4



870-B



870-2CM

Supply

Drainage

Support

Specialties

Appendix

## Cleanout Cover Accessories (Cont)



874-1

Item Number	Item Description	Pkg Type	Min Qty	Case Qty	Price
<b>CLEANOUT COVER SCREW</b>					
874-1	1/4" × 20 Stainless Steel Screw 1-1/2" Length	B	25	1000	\$1.03
874-1C	1/4" × 20 Chrome Plated Screw 1-1/2" Length	B	25	1000	\$1.96
874-1W	1/4" × 20 White Epoxy-Coated Screw 1-1/2" Length	B	25	100	\$3.08
874-2	1/4" × 20 Stainless Steel Screw 2-1/2" Length	B	25	1000	\$1.59
874-2N	1/4" × 20 Nylon Screw 2" Length	B	50	200	\$0.61
874-3C	1/4" × 20 Chrome Plated Screw 3" Length	B	25	500	\$1.90
874-3W	1/4" × 20 White Epoxy-Coated Screw 3" Length	B	25	1000	\$4.31
874-4	1/4" × 20 Stainless Steel Screw 4" Length	B	25	500	\$3.13
874-4C	1/4" × 20 Chrome Plated Screw 4-1/2" Length	B	25	500	\$2.60
874-4W	1/4" × 20 White Epoxy-Coated Screw 4-1/2" Length	B	25	100	\$5.38
874-6	1/4" × 20 Stainless Steel Screw 6" Length	B	25	1000	\$6.27
874-6C	1/4" × 20 Chrome Plated Screw 6" Length	B	25	100	\$3.27
874-6W	1/4" × 20 White Epoxy-Coated Screw 6" Length	B	25	100	\$6.98

Supply

Drainage

Support

Specialties

Appendix



**Inside-Pipe Cleanout Bushing**

Item Number	Item Description	Pkg Type	Min Qty	Case Qty	Price
<b>BUSHING</b>					
875-2A	2" Black ABS Bushing with 1-1/2" Plug	BI	20	20	\$6.63
875-2P	2" White ABS Bushing with 1-1/2" Plug	BI	20	20	\$6.63
875-3A	3" Black ABS Bushing with 2-1/2" Plug	BI	20	20	\$7.96
875-3P	3" White ABS Bushing with 2-1/2" Plug	BI	20	20	\$7.96
875-4A	4" Black ABS Bushing with 3-1/2" Plug	BI	20	20	\$9.63
875-4P	4" White ABS Bushing with 3-1/2" Plug	BI	20	20	\$9.63
<b>BUSHING WITH 16-GA COVER</b>					
875-8230P	2" White ABS Bushing with 1-1/2" Plug & Stnls Steel Cover	BI	1	10	\$15.50
875-8340P	3" White ABS Bushing with 2-1/2" Plug & Stnls Steel Cover	BI	1	10	\$19.81
875-8450P	4" White ABS Bushing with 3-1/2" Plug & Stnls Steel Cover	BI	1	10	\$21.77

**Inside-Pipe Cleanout Fitting**

**with Nickel-Bronze Cover**

Item Number	Item Description	Pkg Type	Min Qty	Case Qty	Price
<b>INSIDE 4" PIPE</b>					
875-84AN	4" ABS Cleanout with Cover	BI	1	12	\$56.52
875-84PN	4" PVC Cleanout with Cover	BI	1	12	\$56.52
<b>INSIDE 3" PIPE</b>					
875-83AN	3" ABS Cleanout with Cover	BI	1	12	\$41.98
875-83PN	3" PVC Cleanout with Cover	BI	1	12	\$41.98



875-3P



875-8230P



875-84PN

Supply

Drainage

Support

Specialties

Appendix

**Polypropylene - Slotted**

Item Number	Item Description	Pkg Type	Min Qty	Case Qty	Price
<b>WITH THREADED BRASS INSERT</b>					
878-15	1-1/2" White	B	25	25	\$2.29
878-15PK	1-1/2" White	CI	25	25	\$2.54
878-20	2" White	B	25	25	\$2.29
878-20PK	2" White	CI	25	25	\$2.54
878-25	2-1/2" White	B	25	25	\$3.01
878-30	3" White	B	25	25	\$3.50
878-30PK	3" White	CI	25	25	\$3.75
878-35	3-1/2" White	B	25	25	\$4.18
878-35PK	3-1/2" White	CI	25	25	\$4.43
878-40	4" White	B	25	25	\$4.86
878-40PK	4" White	CI	25	25	\$5.11
878-50	5" White	B	25	25	\$12.86
878-60	6" White	B	8	8	\$14.60
879-15	1-1/2" Black	B	25	25	\$2.29
879-15PK	1-1/2" Black	CI	25	25	\$2.54
879-20	2" Black	B	25	25	\$2.29
879-20PK	2" Black	CI	25	25	\$2.54
879-25	2-1/2" Black	B	25	25	\$3.01
879-30	3" Black	B	25	25	\$3.50
879-30PK	3" Black	CI	25	25	\$3.75
879-35	3-1/2" Black	B	25	25	\$4.18
879-35PK	3-1/2" Black	CI	25	25	\$4.43
879-40	4" Black	B	25	25	\$4.86
879-40PK	4" Black	CI	25	25	\$5.11
<b>879-50</b>	5" Black	B	20	20	\$12.86
879-60	6" Black	B	8	8	\$14.60
<b>NO INSERT</b>					
878-015	1-1/2" White	B	25	25	\$1.41
878-015PK	1-1/2" White	CI	25	25	\$1.66
878-020	2" White	B	25	25	\$1.53
878-020PK	2" White	B	25	25	\$1.78
878-025	2-1/2" White	B	25	25	\$1.88
878-025PK	2-1/2" White	CI	25	25	\$2.13
878-030	3" White	B	25	25	\$2.11
878-030PK	3" White	CI	25	25	\$2.36
878-035	3-1/2" White	B	25	25	\$2.63
878-035PK	3-1/2" White	CI	25	25	\$2.88
878-040	4" White	B	25	25	\$3.01
878-040PK	4" White	CI	25	25	\$3.26
879-015	1-1/2" Black	B	25	25	\$1.41
879-015PK	1-1/2" Black	CI	25	25	\$1.66
879-020	2" Black	B	25	25	\$1.53
879-020PK	2" Black	CI	25	25	\$1.78
879-025	2-1/2" Black	B	25	25	\$1.88
<b>879-025PK</b>	2-1/2" Black	CI	25	25	\$2.13
879-030	3" Black	B	25	25	\$2.11
879-030PK	3" Black	CI	25	25	\$2.36
879-035	3-1/2" Black	B	25	25	\$2.63
879-035PK	3-1/2" Black	CI	25	25	\$2.88
879-040	4" Black	B	25	25	\$3.01
879-040PK	4" Black	CI	25	25	\$3.26



878-20



878-025

Supply

Drainage

Support

Specialties

Appendix

**Polypropylene - Square-Head**

Item Number	Item Description	Pkg Type	Min Qty	Case Qty	Price
878-S15	1-1/2" White	B	25	25	\$1.41
878-S20	2" White	B	25	25	\$1.60
878-S30	3" White	B	25	25	\$2.28
878-S40	4" White	B	25	25	\$3.22
879-S15	1-1/2" Black	B	25	25	\$1.41
879-S20	2" Black	B	25	25	\$1.60
879-S30	3" Black	B	25	25	\$2.28
879-S40	4" Black	B	25	25	\$3.22



878-S30

**PVC - Spanner**

Item Number	Item Description	Pkg Type	Min Qty	Case Qty	Price
<b>878-915</b>	1-1/2"	B	10	20	\$18.07
878-920	2"	B	10	10	\$18.07
878-930	3"	B	10	10	\$17.58
<b>878-935</b>	3-1/2"	B	10	20	\$18.88
878-940	4"	B	10	10	\$19.41
878-950	5"	B	10	10	\$22.85
878-960	6"	B	10	10	\$29.45
878-980	8"	B	10	10	\$48.88



878-920

Supply

Drainage

Support

Specialties

Appendix

Supply

Drainage

Support

Specialties

Appendix



852-CN2

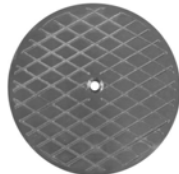

851-CN3



850-CN2



852-CT4

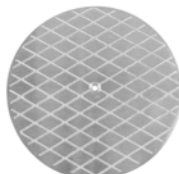

851-CT3

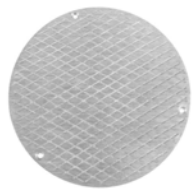

850-CT2

## Replacement Cleanout Covers

### Nickel Bronze Covers

**Options:** Add suffix to item no. Add price to list  
**B** = Beveled Edge for Floor Plate (1): \$10.00;

1: For 851 Series covers

Item Number	Item Description	Pkg Type	Min Qty	Case Qty	Price
<b>FOR 834 &amp; 852 SERIES</b>					
<b>852-CN2</b>	4" Rnd Cover	BI	1	10	\$48.94
852-CN3	5-1/16" Rnd Cover	BI	1	10	\$52.68
<b>852-CN4</b>	6-1/8" Rnd Cover	BI	1	10	\$71.49
<b>852-HCN4</b>	6-1/8" Rnd Cover - Special-Duty	BI	1	1	\$100.83
<b>FOR 851 SERIES</b>					
851-CN3	5-1/4" Rnd Cover	BI	1	10	\$84.41
851-CN4	6-1/8" Rnd Cover	BI	1	10	\$121.13
851-CN6	7-3/4" Rnd Cover	BI	1	10	\$135.82
851-CN8	8-3/8" Rnd Cover	BI	1	10	\$172.48
<b>FOR 850 SERIES</b>					
<b>850-CN2</b>	6-1/16" Rnd Cover	BI	1	10	\$83.12
<b>850-CN3</b>	6-3/8" Rnd Cover	BI	1	10	\$114.79
850-CN4	8-3/8" Rnd Cover	BI	1	1	\$197.91

## Replacement Cleanout Covers

### Tenz-Alloy Covers

**Options:** Add suffix to item no. Add price to list  
**B** = Beveled Edge for Floor Plate (1): \$10.00;

1: For 851 Series covers

Item Number	Item Description	Pkg Type	Min Qty	Case Qty	Price
<b>FOR 834 &amp; 852 SERIES</b>					
<b>852-CT4</b>	6-1/8" Rnd Cover	BI	1	2	\$35.37
<b>FOR 851 SERIES</b>					
851-CT3	5-1/4" Rnd Cover	BI	1	10	\$39.42
851-CT4	6-1/8" Rnd Cover	BI	1	10	\$50.18
851-CT6	7-3/4" Rnd Cover	BI	1	10	\$60.94
851-CT8	8-3/8" Rnd Cover	BI	1	10	\$78.88
<b>FOR 850 SERIES</b>					
850-CT2	6-1/16" Rnd Cover	BI	1	10	\$34.81
850-CT3	6-3/8" Rnd Cover	BI	1	10	\$56.89
850-CT4	8-3/8" Rnd Cover	BI	1	10	\$89.83

**Replacement Cleanout Covers**

**Cast Iron Covers**

Item Number	Item Description	Pkg Type	Min Qty	Case Qty	Price
<b>FOR 834 &amp; 852 SERIES</b>					
852-CD4	6-1/8" Rnd Cover	BI	1	10	\$22.03
<b>852-CI3</b>	5-1/16" Rnd Cover	BI	1	1	\$27.54
852-CI4	6-1/16" Rnd Cover	BI	1	5	\$43.28
852-HCD4	6-1/8" Rnd Cover - Special-Duty	BI	1	1	\$28.88
<b>FOR 851 SERIES</b>					
851-CI3	4-1/8" Rnd Cover	BI	1	1	\$21.84
851-CI4	5-1/8" Rnd Cover	BI	1	1	\$26.23
851-CI6	6-1/8" Rnd Cover	BI	1	10	\$37.50
851-CI8	7-3/4" Rnd Cover	BI	1	10	\$44.98
<b>FOR 850 SERIES</b>					
<b>850-CI2</b>	5-1/8" Rnd Cover	BI	1	1	\$27.90
850-CI3	6-3/16" Rnd Cover	BI	1	1	\$44.47
<b>850-CI4</b>	7-3/4" Rnd Cover	BI	1	1	\$52.54



852-CD4



851-CI3



850-CI3

**Replacement Cleanout Covers**

**Stainless Steel Covers**

Item Number	Item Description	Pkg Type	Min Qty	Case Qty	Price
<b>FOR 834 &amp; 852 SERIES</b>					
<b>852-CS3</b>	5-1/8" Rnd Cover	BI	1	1	\$52.68
<b>852-CS4</b>	6-1/8" Rnd Cover	BI	1	1	\$71.49



852-CS3

**Replacement Cleanout Covers**

**Gray ABS Covers**

Item Number	Item Description	Pkg Type	Min Qty	Case Qty	Price
<b>FOR 834 &amp; 852 SERIES</b>					
<b>852-CP3</b>	5-1/16" Rnd Cover	BI	1	1	\$15.06
<b>852-CP4</b>	6-1/8" Rnd Cover	BI	1	1	\$17.69

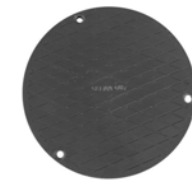

852-CP3



# **Trench Drains**

**FastTrack™ System**

**HydroTec™ System**

**HydroBlock™ System**

**HydroLine™ System**

# Trench Drains

## FastTrack™ System

Sloped and neutral channels made from engineered high-density polyethylene. DIN EN load ratings from A15 to D400. Designed in accordance with ASME A112.6.3 Standard for Floor and Trench Drains.

## HydroTec™ System

Sloped and neutral channels constructed from reinforced concrete with integral edge rails. DIN EN load ratings up to F900. Designed in accordance with ASME A112.6.3 Standard for Floor and Trench Drains.

## HydroBlock™ System

One-piece ductile iron channel and grate system designed for heavy loads and high-traffic areas. DIN EN load rating up to F900.

## HydroLine™ System

Low-profile, one-piece channels made from ductile iron or aluminum lock into concrete slab for heavy-duty traffic. DIN EN load rating up to F900



# FastTrack™ System

**Drain Channels**

**Grates**

**Accessories**

FastTrack™ channels are tough, lightweight, and chemical-resistant. Channels include integral rebar clips, grate anchors and bottom outlet.

Multiple grate options available for applications from pedestrian traffic to heavy-duty loads.

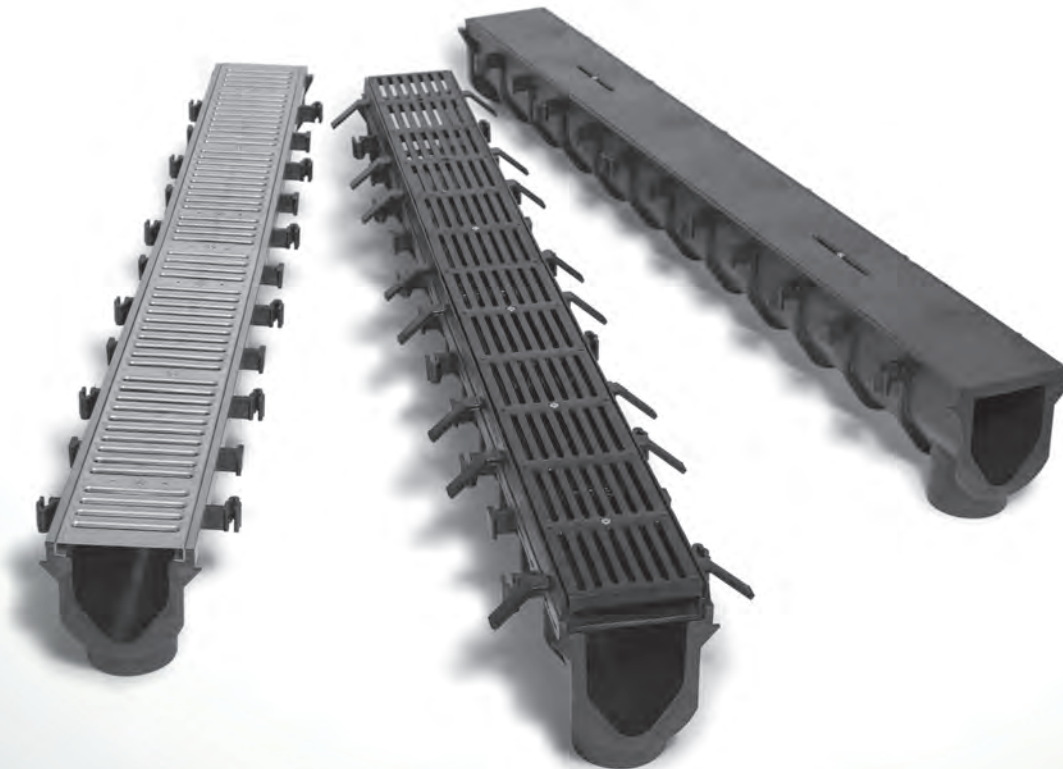



Drain Channels

Item Number	Item Description	Pkg Type	Min Qty	Case Qty	Price
<b>SLOPED SECTIONS</b>					
865-S1	Sloped Channel Section w/ Construction Cover-72" Long	B	1	1	\$246.15
865-S2	Sloped Channel Section w/ Construction Cover-72" Long	B	1	1	\$246.15
865-S3	Sloped Channel Section w/ Construction Cover-72" Long	B	1	1	\$246.15
865-S4	Sloped Channel Section w/ Construction Cover-72" Long	B	1	1	\$246.15
865-S5	Sloped Channel Section w/ Construction Cover-72" Long	B	1	1	\$246.15
865-S6	Sloped Channel Section w/ Construction Cover-72" Long	B	1	1	\$246.15
865-S7	Sloped Channel Section w/ Construction Cover-72" Long	B	1	1	\$246.15
865-S8	Sloped Channel Section w/ Construction Cover-72" Long	B	1	1	\$246.15
865-S9	Sloped Channel Section w/ Construction Cover-72" Long	B	1	1	\$246.15
<b>NEUTRAL SECTIONS</b>					
865-N3	Neutral Channel Section w/ Construction Cover - 72" Long	B	1	1	\$246.15
865-N5	Neutral Channel Section w/ Construction Cover-72" Long	B	1	1	\$246.15
865-N7	Neutral Channel Section w/ Construction Cover-72" Long	B	1	1	\$246.15
865-N9	Neutral Channel Section w/ Construction Cover-72" Long	B	1	1	\$246.15



865-S3

Grates

Item Number	Item Description	Pkg Type	Min Qty	Case Qty	Price
<b>DUCTILE IRON GRATES</b>					
865-GIC	Cross-Slot Ductile Iron Grate w/ Screws - Class C - 36" Long	BI	1	1	\$256.34
865-GID	Diagonal-Slot Ductile Iron Grate w/ Screws - Class C - 36" Long	BI	1	1	\$256.34
865-GIS	Slotted Ductile Iron Grate w/ Screws - Class D - 36" Long	BI	1	1	\$242.47
<b>STAINLESS STEEL GRATES</b>					
865-GSA	Angle-Slot Grate w/ Screws - Class A - 36" Long	BI	1	1	\$207.84
865-GSB	Brick Slot Stainless Steel Grate w/ Screws - Class C -36	BI	1	2	\$516.53
865-GSD	Perforated Stainless Steel Grate w/ Screws - Class A - 36" Long	BI	1	1	\$214.78
865-GSS	Slotted Stainless Steel Grate w/ Screws - Class A - 36" Long	BI	1	1	\$210.98
865-GSSR	Reinforced Slotted Stainless Steel Grate w/ Screws - Class C - 36" Long	BI	1	1	\$298.26
<b>GALVANIZED STEEL GRATES</b>					
865-GGD	Perforated Galvanized Steel Grate w/ Screws - Class A - 36" Long	BI	1	1	\$187.07
865-GGS	Slotted Galvanized Steel Grate w/ Screws - Class A - 36" Long	BI	1	1	\$165.69
865-GGSR	Reinforced Slotted Galvanized Steel Grate w/ Screws - Class C - 36" Long	BI	1	1	\$245.21



865-GIC



865-GSD



865-GGS

Supply

Drainage

Support

Specialties

Appendix

Supply

Drainage

Support

Specialties

Appendix



865-GHS



865-D



865-F



865-FCB

### Grates (Cont)

Item Number	Item Description	Pkg Type	Min Qty	Case Qty	Price
<b>POLYMER GRATES</b>					
865-GHC	Cross-Slot GFPP Grate w/ Screws - Class A - 36" Long	BI	1	1	\$160.36
865-GHS	Slotted HDPE Grate w/ Screws - Class A - 36" Long	BI	1	2	\$138.56

### Accessories

Item Number	Item Description	Pkg Type	Min Qty	Case Qty	Price
865-A	Grate Anchor - Stainless – Fits All Channels	B	1	20	\$6.17
<b>865-C</b>	Construction Cover - HDPE 36" Long - Fits All FastTrack Channels	B	1	1	\$15.78
865-CB4	4" Outlet Adapter for Catch Basin - Fits 3" & 4" Sch. 40, 4" SDR35 pipe	BI	1	1	\$40.00
865-CB6	6" Outlet Adapter for Catch Basin - Fits 6" SDR35 pipe	BI	1	1	\$40.00
865-D	Dome Bottom Strainer - Stainless Steel – For Bottom Outlet	BI	1	1	\$34.76
865-EC	End Cap - HDPE Flat Cap – Fits All Channels	BI	1	50	\$28.10
865-EG	SS Edge Guards w/Screws, 36" Long, 2/Box	BI	1	1	\$112.33
865-EO	End Outlet - HDPE w/ 4" No-Hub Connection	BI	1	25	\$28.10
865-F	Ductile Iron Grate Frame - 36" Long w/ Screws	BI	1	1	\$159.34
865-FB	Debris Basket - Fits FastTrack Catch Basin	BI	1	1	\$253.00
865-FC	Catch Basin - 36" Long - Fits All FastTrack Channels	BI	1	1	\$267.00
865-FCB	Catch Basin w/Basket - 36" Long - Fits All FastTrack Channels	BI	1	1	\$520.00
865-S15	Screws For FastTrack Grate, 1-1/2", 3/Bag	BI	1	100	\$5.10

# HydroTec™ System

HydroTec™ Maxi

HydroTec™ Top

HydroTec™ trench drain systems are constructed from fiber-reinforced concrete channels with integral ductile iron (Maxi system) or galvanized steel (Top system) edge rails. Grates are available with bolt-less locking feature or 'F1' locking option.

Highly stable and suitable for a variety of applications, with load ratings up to F900.

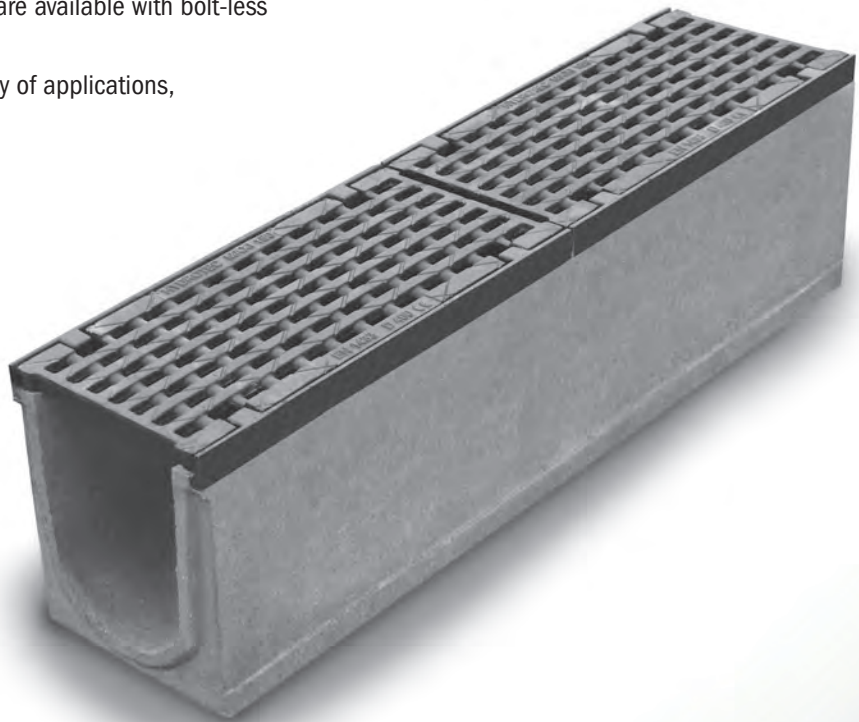



**865-M4N10**  
Page 383



**865-M6S01DA**  
Page 385



**865-M6S01FA**  
Page 386



**865-M8N00DA**  
Page 387

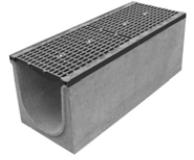

**865-M12PN00EA**  
Page 387

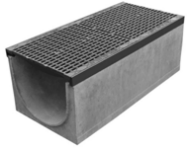

**865-M16PN00EA**  
Page 388



**865-T4N10**  
Page 389



**865-T6N00**  
Page 392



**865-T8N00**  
Page 393

**HydroTec™ MAXI System**

**Maxi 100 - 4" Wide**



865-M4DICH

Item Number	Item Description	Pkg Type	Min Qty	Case Qty	Price
<b>GRATES</b>					
865-M4DICH	Half-Meter, Class C, Ductile Iron, Heel Proof Slot	B	1	1	\$69.97
865-M4DICT	Half-Meter, Class C, Ductile Iron, Transverse Slot	B	1	1	\$54.35
865-M4DIDL	Half-Meter, Class D, Ductile Iron, Long Slot, ADA	B	1	1	\$72.81
865-M4DIFH	Half-Meter, Class F, Ductile Iron, Heel Proof Slot	B		1	\$118.36
865-M4DIFL	Half-Meter, Class F, Ductile Iron, Long Slot, ADA	B	1	1	\$122.63
<b>CHANNELS</b>					
865-M4N10	One-Meter, 4" Wide × 6.30" Height, Neutral	B	1	1	\$178.26
865-M4N105	Half-Meter, 4" Wide × 6.30" Height, Neutral	B	1	1	\$156.77
865-M4N105S	Half-Meter, 4" Wide × 6.30" Height, Neutral, Side Out	B	1	1	\$182.58
865-M4N10B	One-Meter, 4" Wide × 6.30" Height, Neutral, Bottom Out	B	1	1	\$225.81
865-M4N15	One-Meter, 4" Wide × 7.28" Height, Neutral	B	1	1	\$178.26
865-M4N155	Half-Meter, 4" Wide × 7.28" Height, Neutral	B	1	1	\$156.77
865-M4N155S	Half-Meter, 4" Wide × 7.28" Height, Neutral, Side Out	B	1	1	\$182.58
865-M4N15B	One-Meter, 4" Wide × 7.28" Height, Neutral, Bottom Out	B	1	1	\$225.81
865-M4N20	One-Meter, 4" Wide × 8.27" Height, Neutral	B	1	1	\$178.26
865-M4N205	Half-Meter, 4" Wide × 8.27" Height, Neutral	B	1	1	\$156.77
865-M4N205S	Half-Meter, 4" Wide × 8.27" Height, Neutral, Side Out	B	1	1	\$182.58
865-M4N20B	One-Meter, 4" Wide × 8.27" Height, Neutral, Bottom Out	B	1	1	\$225.81
865-M4N25	One-Meter, 4" Wide × 9.25" Height, Neutral	B	1	1	\$178.26
865-M4N255	Half-Meter, 4" Wide × 9.25" Height, Neutral	B	1	1	\$156.77
865-M4N255S	Half-Meter, 4" Wide × 9.25" Height, Neutral, Side Out	B	1	1	\$182.58
865-M4N25B	One-Meter, 4" Wide × 9.25" Height, Neutral, Bottom Out	B	1	1	\$225.81
865-M4N30	One-Meter, 4" Wide × 10.2" Height, Neutral	B	1	1	\$178.26
865-M4N305	Half-Meter, 4" Wide × 10.2" Height, Neutral	B	1	1	\$156.77
865-M4N305S	Half-Meter, 4" Wide × 10.2" Height, Neutral, Side Out	B	1	1	\$182.58
865-M4N30B	One-Meter, 4" Wide × 10.2" Height, Neutral, Bottom Out	B	1	1	\$225.81
865-M4S01	One-Meter, 4" Wide, Slope # 1	B	1	1	\$178.26
865-M4S02	One-Meter, 4" Wide, Slope # 2	B	1	1	\$178.26
865-M4S03	One-Meter, 4" Wide, Slope # 3	B	1	1	\$178.26
865-M4S04	One-Meter, 4" Wide, Slope # 4	B	1	1	\$178.26
865-M4S05	One-Meter, 4" Wide, Slope # 5	B	1	1	\$178.26
865-M4S06	One-Meter, 4" Wide, Slope # 6	B	1	1	\$178.26
865-M4S07	One-Meter, 4" Wide, Slope # 7	B	1	1	\$178.26
865-M4S08	One-Meter, 4" Wide, Slope # 8	B	1	1	\$178.26
865-M4S09	One-Meter, 4" Wide, Slope # 9	B	1	1	\$178.26
865-M4S10	One-Meter, 4" Wide, Slope # 10	B	1	1	\$178.26
865-M4S11	One-Meter, 4" Wide, Slope # 11	B	1	1	\$178.26
865-M4S12	One-Meter, 4" Wide, Slope # 12	B	1	1	\$178.26
865-M4S13	One-Meter, 4" Wide, Slope # 13	B	1	1	\$178.26
865-M4S14	One-Meter, 4" Wide, Slope # 14	B	1	1	\$178.26
865-M4S15	One-Meter, 4" Wide, Slope # 15	B	1	1	\$178.26
865-M4S16	One-Meter, 4" Wide, Slope # 16	B	1	1	\$178.26
865-M4S17	One-Meter, 4" Wide, Slope # 17	B	1	1	\$178.26

Supply

Drainage

Support

Specialties

Appendix

## HydroTec™ MAXI System (Cont)

### Maxi 100 - 4" Wide

Item Number	Item Description	Pkg Type	Min Qty	Case Qty	Price
<b>CHANNELS</b>					
865-M4S18	One-Meter, 4" Wide, Slope # 18	B	1	1	\$178.26
865-M4S19	One-Meter, 4" Wide, Slope # 19	B	1	1	\$178.26
865-M4S20	One-Meter, 4" Wide, Slope # 20	B	1	1	\$178.26
865-M4S21	One-Meter, 4" Wide, Slope # 21	B	1	1	\$178.26
865-M4S22	One-Meter, 4" Wide, Slope # 22	B	1	1	\$178.26
865-M4S23	One-Meter, 4" Wide, Slope # 23	B	1	1	\$178.26
865-M4S24	One-Meter, 4" Wide, Slope # 24	B	1	1	\$178.26
865-M4S25	One-Meter, 4" Wide, Slope # 25	B	1	1	\$178.26
865-M4S26	One-Meter, 4" Wide, Slope # 26	B	1	1	\$178.26
865-M4S27	One-Meter, 4" Wide, Slope # 27	B	1	1	\$178.26
865-M4S28	One-Meter, 4" Wide, Slope # 28	B	1	1	\$178.26
865-M4S29	One-Meter, 4" Wide, Slope # 29	B	1	1	\$178.26
865-M4S30	One-Meter, 4" Wide, Slope # 30	B	1	1	\$178.26
<b>LOW-PROFILE CHANNELS</b>					
865-M4LP00	One-Meter, 4" Wide × 3.15" Height, Neutral	B	1	1	\$178.26
865-M4LP005	Half-Meter, 4" Wide × 3.15" Height, Neutral	B	1	1	\$156.77
865-M4LP00B	One-Meter, 4" Wide × 3.15" Height, Neutral, Bottom Out	B	1	1	\$225.81
865-M4N00	One-Meter, 4" Wide × 4.33" Height, Neutral	B	1	1	\$178.26
865-M4N005	Half-Meter, 4" Wide × 4.33" Height, Neutral	B	1	1	\$156.77
865-M4N00B	One-Meter, 4" Wide × 4.33" Height, Neutral, Bottom Out	B	1	1	\$225.81
<b>CATCH BASIN</b>					
865-M4CB	Half-Meter, Catch Basin w/ Galv Steel Debris Basket - 6" Outlet	B	1	1	\$348.62
<b>ACCESSORIES</b>					
865-4BK	Installation Bracket for Maxi/Top 100 Channels	B	1	1	\$44.50
865-4EC	4" Closed End Cap - 2 Piece	B	1	1	\$38.60
865-4LPEC3	4" Closed End Cap For 3.15" Channel	B	1	1	\$27.97
865-4LPEC4	4" Closed End Cap For 4.33" Channel	B	1	1	\$27.97
865-4LR	Grate-Locking Rod For 4" Channels	B	1	1	\$1.63
865-4OC	4" Open End Cap - 2 Piece	B	1	1	\$38.60
865-4PC	4" PVC S&D Pipe Connection	B	1	1	\$13.98
865-4RS	4" Rubber Sleeve / Seal For Bottom Outs	B	1	1	\$51.36
865-SHOVEL	Cleaning Shovel For Mini/Top/Maxi	B	1	1	\$191.97
865-TOOL	Grate-Locking Tool	B	1	1	\$36.92

Supply

Drainage

Support

Specialties

Appendix



865-M4N10



865-M4LP00



865-M4CB



865-TOOL



**HydroTec™ MAXI System**

**Maxi 150 - 6" Wide**



865-M6S01DA

Item Number	Item Description	Pkg Type	Min Qty	Case Qty	Price
<b>CHANNELS - CLASS D GRATE</b>					
865-M6CBDA	Half-Meter, Catch Basin w/ Galv Basket And Class D Ductile Iron ADA Grate - 6" Outlet	B	1	1	\$846.42
865-M6N005DA	Half-Meter, 6" Wide × 8.27" Height, Neutral w/ Class D ADA Ductile Iron Grate	B	1	1	\$300.57
865-M6N005SDA	Half-Meter, 6" Wide × 8.27" Height, Neutral, Side Out w/ Class D ADA Ductile Iron Grate	B	1	1	\$350.74
865-M6N00BDA	One-Meter, 6" Wide × 8.27" Height, Neutral, Bottom Out w/ Class D ADA Ductile Iron Grate	B	1	1	\$610.48
865-M6N00DA	One-Meter, 6" Wide × 8.27" Height, Neutral w/ Class D ADA Ductile Iron Grate	B	1	1	\$493.75
865-M6N055DA	Half-Meter, 6" Wide × 10.23" Height, Neutral w/ Class D ADA Ductile Iron Grate	B	1	1	\$300.57
865-M6N055SDA	Half-Meter, 6" Wide × 10.23" Height, Neutral, Side Out w/ Class D ADA Ductile Iron Grate	B	1	1	\$350.74
865-M6N05BDA	One-Meter, 6" Wide × 10.23" Height, Neutral, Bottom Out w/ Class D ADA Ductile Iron Grate	B	1	1	\$610.48
865-M6N05DA	One-Meter, 6" Wide × 10.23" Height, Neutral w/ Class D ADA Ductile Iron Grate	B	1	1	\$493.75
865-M6N105DA	Half-Meter, 6" Wide × 12.20" Height, Neutral w/ Class D ADA Ductile Iron Grate	B	1	1	\$300.57
865-M6N105SDA	Half-Meter, 6" Wide × 12.20" Height, Neutral, Side Out w/ Class D ADA Ductile Iron Grate	B	1	1	\$350.74
865-M6N10BDA	One-Meter, 6" Wide × 12.20" Height, Neutral, Bottom Out w/ Class D ADA Ductile Iron Grate	B	1	1	\$610.48
865-M6N10DA	One-Meter, 6" Wide × 12.20" Height, Neutral w/ Class D ADA Ductile Iron Grate	B	1	1	\$493.75
865-M6S01DA	One-Meter, 6" Wide, Slope # 1 w/ Class D ADA Ductile Iron Grate	B	1	1	\$493.75
865-M6S02DA	One-Meter, 6" Wide, Slope # 2 w/ Class D ADA Ductile Iron Grate	B	1	1	\$493.75
865-M6S03DA	One-Meter, 6" Wide, Slope # 3 w/ Class D ADA Ductile Iron Grate	B	1	1	\$493.75
865-M6S04DA	One-Meter, 6" Wide, Slope # 4 w/ Class D ADA Ductile Iron Grate	B	1	1	\$493.75
865-M6S05DA	One-Meter, 6" Wide, Slope # 5 w/ Class D ADA Ductile Iron Grate	B	1	1	\$493.75
865-M6S06DA	One-Meter, 6" Wide, Slope # 6 w/ Class D ADA Ductile Iron Grate	B	1	1	\$493.75
865-M6S07DA	One-Meter, 6" Wide, Slope # 7 w/ Class D ADA Ductile Iron Grate	B	1	1	\$493.75
865-M6S08DA	One-Meter, 6" Wide, Slope # 8 w/ Class D ADA Ductile Iron Grate	B	1	1	\$493.75
865-M6S09DA	One-Meter, 6" Wide, Slope # 9 w/ Class D ADA Ductile Iron Grate	B	1	1	\$493.75
865-M6S10DA	One-Meter, 6" Wide, Slope # 10 w/ Class D ADA Ductile Iron Grate	B	1	1	\$493.75
<b>CHANNELS - CLASS F GRATE</b>					
865-M6CBFA	Half-Meter, Catch Basin w/ Galv Basket And Class F ADA Ductile Iron Grate - 6" Outlet	B	1	1	\$893.02
865-M6N005FA	Half-Meter, 6" Wide × 8.27" Height, Neutral w/ Class F ADA Ductile Iron Grate	B	1	1	\$346.79
865-M6N005SFA	Half-Meter, 6" Wide × 8.27" Height, Neutral, Side Out w/ Class F ADA Ductile Iron Grate	B	1	1	\$399.22
865-M6N00FA	One-Meter, 6" Wide × 8.27" Height, Neutral w/ Class F ADA Ductile Iron Grate	B	1	1	\$556.50
865-M6N055FA	Half-Meter, 6" Wide × 10.23" Height, Neutral w/ Class F ADA Ductile Iron Grate	B	1	1	\$346.79
865-M6N055SFA	Half-Meter, 6" Wide × 10.23" Height, Neutral, Side Out w/ Class F ADA Ductile Iron Grate	B	1	1	\$399.22

Supply

Drainage

Support

Specialties

Appendix

## HydroTec™ MAXI System (Cont)

### Maxi 150 - 6" Wide

Item Number	Item Description	Pkg Type	Min Qty	Case Qty	Price
<b>CHANNELS - CLASS F GRATE</b>					
865-M6N05BFA	One-Meter, 6" Wide × 10.23" Height, Neutral, Bottom Out w/ Class F ADA Ductile Iron Grate	B	1	1	\$671.97
865-M6N05FA	One-Meter, 6" Wide × 10.23" Height, Neutral w/ Class F ADA Ductile Iron Grate	B	1	1	\$556.50
865-M6N105FA	Half-Meter, 6" Wide × 12.20" Height, Neutral w/ Class F ADA Ductile Iron Grate	B	1	1	\$346.79
865-M6N105SFA	Half-Meter, 6" Wide × 12.20" Height, Neutral, Side Out w/ Class F ADA Ductile Iron Grate	B	1	1	\$399.22
865-M6N10BFA	One-Meter, 6" Wide × 12.20" Height, Neutral, Bottom Out w/ Class F ADA Ductile Iron Grate	B	1	1	\$671.97
865-M6N10FA	One-Meter, 6" Wide × 12.20" Height, Neutral w/ Class F ADA Ductile Iron Grate	B	1	1	\$556.50
865-M6S01FA	One-Meter, 6" Wide, Slope # 1 w/ Class F ADA Ductile Iron Grate	B	1	1	\$556.50
865-M6S02FA	One-Meter, 6" Wide, Slope # 2 w/ Class F ADA Ductile Iron Grate	B	1	1	\$556.50
865-M6S03FA	One-Meter, 6" Wide, Slope # 3 w/ Class F ADA Ductile Iron Grate	B	1	1	\$556.50
865-M6S04FA	One-Meter, 6" Wide, Slope # 4 w/ Class F ADA Ductile Iron Grate	B	1	1	\$556.50
865-M6S05FA	One-Meter, 6" Wide, Slope # 5 w/ Class F ADA Ductile Iron Grate	B	1	1	\$556.50
865-M6S06FA	One-Meter, 6" Wide, Slope # 6 w/ Class F ADA Ductile Iron Grate	B	1	1	\$556.50
865-M6S07FA	One-Meter, 6" Wide, Slope # 7 w/ Class F ADA Ductile Iron Grate	B	1	1	\$556.50
865-M6S08FA	One-Meter, 6" Wide, Slope # 8 w/ Class F ADA Ductile Iron Grate	B	1	1	\$556.50
865-M6S09FA	One-Meter, 6" Wide, Slope # 9 w/ Class F ADA Ductile Iron Grate	B	1	1	\$556.50
865-M6S10FA	One-Meter, 6" Wide, Slope # 10 w/ Class F ADA Ductile Iron Grate	B	1	1	\$556.50
<b>CHANNELS - CLASS F GRATE WITH F1-LOCKING FEATURE</b>					
865-M6CBF1A	Half-Meter, Catch Basin w/ Galv Basket And F1 Class F ADA Grate - 6" Outlet	B	1	1	\$923.56
865-M6N005F1A	Half-Meter, 6" Wide × 8.27" Height, Neutral w/ F1 Class F ADA Ductile Iron Grate	B	1	1	\$377.33
865-M6N005SF1A	Half-Meter, 6" Wide × 8.27" Height, Neutral, Side Out w/ F1 Class F ADA Ductile Iron Grate	B	1	1	\$429.76
865-M6N00BF1A	One-Meter, 6" Wide × 8.27" Height, Neutral, Bottom Out w/ F1 Class F ADA Ductile Iron Grate	B	1	1	\$733.07
865-M6N00F1A	One-Meter, 6" Wide × 8.27" Height, Neutral w/ F1 Class F ADA Ductile Iron Grate	B	1	1	\$617.59
<b>ACCESSORIES</b>					
865-6LR	Grate-Locking Rod For 6" Channels	B	1	1	\$2.19
865-6PC	PVC S&D Pipe Connection for 6" Outs	B	1	1	\$25.72
865-6PCE	6" Oval PVC Pipe Connection	B	1	1	\$42.50
865-6RS	Rubber Sleeve/Seal For 6" Bottom Outs	B	1	1	\$61.52
865-6UC	6" Universal End Cap - Open & Closed	BI	1	20	\$46.73
865-SHOVEL	Cleaning Shovel For Mini/Top/Maxi	B	1	1	\$191.97
865-TOOL	Grate-Locking Tool	B	1	1	\$36.92



865-M6S01FA



865-6UC

Supply

Drainage

Support

Specialties

Appendix

**HydroTec™ MAXI System**

**Maxi 200 - 8" Wide**

Item Number	Item Description	Pkg Type	Min Qty	Case Qty	Price
<b>CHANNELS - CLASS D GRATE</b>					
865-M8CBDA	Half-Meter, Catch Basin w/ Galv Basket And Class D ADA Ductile Iron Grate - 6" Outlet	B	1	1	\$833.90
865-M8N005DA	Half-Meter, 8" Wide × 12.20" Height w/ Class D ADA Ductile Iron Grate	B	1	1	\$393.16
865-M8N005SDA	Half-Meter, 8" Wide × 12.20" Height, Side Out w/ Class D ADA Ductile Iron Grate	B	1	1	\$436.47
865-M8N00BDA	One-Meter, 8" Wide × 12.20" Height, Bottom Out w/ Class D ADA Ductile Iron Grate	B	1	1	\$724.91
865-M8N00DA	One-Meter, 8" Wide × 12.20" Height w/ Class D ADA Ductile Iron Grate	B	1	1	\$651.56
<b>CHANNELS - CLASS F GRATE</b>					
865-M8CBFA	Half-Meter, Catch Basin w/ Galv Basket And Class F ADA Ductile Iron Grate - 6" Outlet	B	1	1	\$882.05
865-M8N005FA	Half-Meter, 8" Wide × 12.20" Height w/ Class F ADA Ductile Iron Grate	B	1	1	\$431.26
865-M8N005SFA	Half-Meter, 8" Wide × 12.20" Height, Side Out w/ Class F ADA Ductile Iron Grate	B	1	1	\$483.45
865-M8N00BFA	One-Meter, 8" Wide × 12.20" Height, Bottom Out w/ Class F ADA Ductile Iron Grate	B	1	1	\$789.74
865-M8N00FA	One-Meter, 8" Wide × 12.20" Height w/ Class F ADA Ductile Iron Grate	B	1	1	\$718.95
<b>CHANNELS - CLASS F GRATE WITH F1-LOCKING FEATURE</b>					
865-M8CBF1A	Half-Meter, Catch Basin w/ Galv Basket And F1 Class F ADA Ductile Iron Grate - 6" Outlet	B	1	1	\$915.34
865-M8N005F1A	Half-Meter, 8" Wide × 12.20" Height w/ F1 Class F ADA Ductile Iron Grate	B	1	1	\$438.88
865-M8N005SF1A	Half-Meter, 8" Wide × 12.20" Height, Side Out w/ F1 Class F ADA Ductile Iron Grate	B	1	1	\$516.75
865-M8N00BF1A	One-Meter, 8" Wide × 12.20" Height, Bottom Out w/ F1 Class F ADA Ductile Iron Grate	B	1	1	\$856.32
865-M8N00F1A	One-Meter, 8" Wide × 12.20" Height w/ F1 Class F ADA Ductile Iron Grate	B	1	1	\$732.11
<b>ACCESSORIES</b>					
865-6PC	PVC S&D Pipe Connection for 6" Outs	B	1	1	\$25.72
865-6RS	Rubber Sleeve/Seal For 6" Bottom Outs	B	1	1	\$61.52
865-8LR	Grate-Locking Rod For 8" Channels	B	1	1	\$2.04
865-8UC	Universal End Cap - Open & Closed	BI	1	20	\$53.39
865-SHOVEL	Cleaning Shovel For Mini/Top/Maxi	B	1	1	\$191.97
865-TOOL	Grate-Locking Tool	B	1	1	\$36.92



865-M8N00DA



865-TOOL

**HydroTec™ MAXI System**

**Maxi 300 - 12" Wide**

Item Number	Item Description	Pkg Type	Min Qty	Case Qty	Price
<b>CHANNELS - CLASS E GRATE WITH F1-LOCKING FEATURE</b>					
865-M12PCBEA	Half-Meter, Catch Basin w/ Galv Basket And Class E ADA Ductile Iron Grate - 8" Outlet	B	1	1	\$1,662.42
865-M12PN005EA	Half-Meter, 12" Wide × 15.75" Height w/ Class E ADA Ductile Iron Grate	B	1	1	\$755.54
865-M12PN00BEA	One-Meter, 12" Wide × 15.75" Height, Bottom Out w/ Class E ADA Ductile Iron Grate	B	1	1	\$1,476.24
865-M12PN00EA	One-Meter, 12" Wide × 15.75" Height w/ Class E ADA Ductile Iron Grate	B	1	1	\$1,318.15

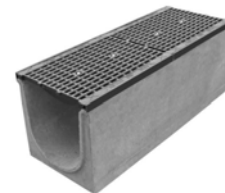

865-M12PN00EA

## HydroTec™ MAXI System (Cont)

### Maxi 300 - 12" Wide

Item Number	Item Description	Pkg Type	Min Qty	Case Qty	Price
<b>CHANNELS - CLASS F GRATE WITH F1-LOCKING FEATURE</b>					
865-M12PCBFA	Half-Meter, Catch Basin w/ Galv Basket And Class F ADA Ductile Iron Grate - 8" Outlet	B	1	1	\$1,823.01
865-M12PN005FA	Half-Meter, 12" Wide × 15.75" Height w/ Class F ADA Ductile Iron Grate	B	1	1	\$824.57
865-M12PN00BFA	One-Meter, 12" Wide × 15.75" Height, Bottom Out w/ Class F ADA Ductile Iron Grate	B	1	1	\$1,603.44
865-M12PN00FA	One-Meter, 12" Wide × 15.75" Height w/ Class F ADA Ductile Iron Grate	B	1	1	\$1,444.00
<b>ACCESSORIES</b>					
865-12ECD	12" Closed End Cap - 1 Piece Iron	B	1	1	\$134.29
865-12OCD	12" Open End Cap - 1 Piece Iron	B	1	1	\$265.78
865-8PC	PVC S&D Pipe Connection for 8" Outs	B	1	1	\$38.14
865-8RS	Rubber Sleeve/Seal For 8" Bottom Outs	B	1	1	\$78.31
865-SHOVEL	Cleaning Shovel For Mini/Top/Maxi	B	1	1	\$191.97

## HydroTec™ MAXI System

### Maxi 400 - 16" Wide

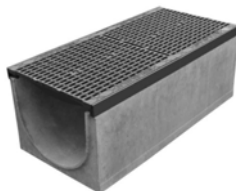

865-M16PN00EA

Item Number	Item Description	Pkg Type	Min Qty	Case Qty	Price
<b>CHANNELS - CLASS E GRATE WITH F1-LOCKING FEATURE</b>					
865-M16PCBEA	Half-Meter, Catch Basin w/ Galv Basket And Class E ADA Ductile Iron Grate - 8" Outlet	B	1	1	\$2,270.30
865-M16PN005EA	Half-Meter, 16" Wide × 15.75" Height w/ Class E ADA Ductile Iron Grate	B	1	1	\$1,015.32
865-M16PN00BEA	One-Meter, 16" Wide × 15.75" Height, Bottom Out w/ Class E ADA Ductile Iron Grate	B	1	1	\$1,896.20
865-M16PN00EA	One-Meter, 16" Wide × 15.75" Height w/ Class E ADA Ductile Iron Grate	B	1	1	\$1,751.10
<b>CHANNELS - CLASS F GRATE WITH F1-LOCKING FEATURE</b>					
865-M16PCBFA	Half-Meter, Catch Basin w/ Galv Basket And Class F ADA Ductile Iron Grate - 8" Outlet	B	1	1	\$2,585.58
865-M16PN005FA	Half-Meter, 16" Wide × 15.75" Height w/ Class F ADA Ductile Iron Grate	B	1	1	\$1,155.14
865-M16PN00BFA	One-Meter, 16" Wide × 15.75" Height, Bottom Out w/ Class F ADA Ductile Iron Grate	B	1	1	\$2,134.08
865-M16PN00FA	One-Meter, 16" Wide × 15.75" Height w/ Class F ADA Ductile Iron Grate	B	1	1	\$1,983.83
<b>ACCESSORIES</b>					
865-16ECD	16" Ductile Closed End Cap	B	1	1	\$165.11
865-16OCD	16" Ductile Open End Cap	B	1	1	\$316.12
865-8PC	PVC S&D Pipe Connection for 8" Outs	B	1	1	\$38.14
865-8RS	Rubber Sleeve/Seal For 8" Bottom Outs	B	1	1	\$78.31
865-SHOVEL	Cleaning Shovel For Mini/Top/Maxi	B	1	1	\$191.97

HydroTec™ TOP System

Top 100 - 4" Wide

Item Number	Item Description	Pkg Type	Min Qty	Case Qty	Price
<b>GRATES</b>					
865-T4DI5CL	Half-Meter, Class C, Ductile Iron, Long Slot, ADA	B	1	1	\$69.74
865-T4DI5CX	Half-Meter, Class C, Ductile Iron, Cross-Slot	B	1	1	\$64.66
865-T4GS5AS	Half-Meter, Class A, Galvanized Steel, Slotted	B	1	1	\$35.05
865-T4GS5CM	Half-Meter, Class C, Galvanized Steel, Mesh, ADA	B	1	1	\$92.69
865-T4GS5CP	Half-Meter, Class C, Galvanized Steel, Perforated	B	1	1	\$100.46
865-T4GS5CS	Half-Meter, Class C, Galvanized Steel, Slotted	B	1	1	\$87.88
865-T4GSA5P	Half-Meter, Class A, Galvanized Steel, Perforated	B	1	1	\$54.87
865-T4GSAP	One-Meter, Class A, Galvanized Steel, Perforated	B	1	1	\$87.47
865-T4GSAS	One-Meter, Class A, Galvanized Steel, Slotted	B	1	1	\$57.69
865-T4GSCM	One-Meter, Class C, Galvanized Steel, Mesh, ADA	B	1	1	\$134.18
865-T4GSCP	One-Meter, Class C, Galvanized Steel, Perforated	B	1	1	\$165.40
865-T4GSCS	One-Meter, Class C, Galvanized Steel, Slotted	B	1	1	\$124.39
865-T4P5BL	Half-Meter, Class B, Plastic, Long Slot, ADA	B	1	1	\$69.74
<b>CHANNELS</b>					
865-T4N10	One-Meter, 4" Wide × 6.30" Height, Neutral	B	1	1	\$139.45
865-T4N105	Half-Meter, 4" Wide × 6.30" Height, Neutral	B	1	1	\$93.76
865-T4N105S	Half-Meter, 4" Wide × 6.30" Height, Neutral, Side Out	B	1	1	\$119.80
865-T4N10B	One-Meter, 4" Wide × 6.30" Height, Neutral, Bottom Out	B	1	1	\$195.23
865-T4N15	One-Meter, 4" Wide × 7.28 Height, Neutral	B	1	1	\$139.45
865-T4N155	Half-Meter, 4" Wide × 7.28 Height, Neutral	B	1	1	\$93.76
865-T4N155S	Half-Meter, 4" Wide × 7.28 Height, Neutral, Side Out	B	1	1	\$119.80
865-T4N15B	One-Meter, 4" Wide × 7.28 Height, Neutral, Bottom Out	B	1	1	\$195.23
865-T4N20	One-Meter, 4" Wide × 8.27 Height, Neutral	B	1	1	\$139.45
865-T4N205	Half-Meter, 4" Wide × 8.27 Height, Neutral	B	1	1	\$93.76
865-T4N205S	Half-Meter, 4" Wide × 8.27 Height, Neutral, Side Out	B	1	1	\$119.80
865-T4N20B	One-Meter, 4" Wide × 8.27 Height, Neutral, Bottom Out	B	1	1	\$195.23
865-T4S01	One-Meter, 4" Wide, Slope # 1 w/ Galv Edge-Rails	B	1	1	\$139.45
865-T4S02	One-Meter, 4" Wide, Slope # 2 w/ Galv Edge-Rails	B	1	1	\$139.45
865-T4S03	One-Meter, 4" Wide, Slope # 3 w/ Galv Edge-Rails	B	1	1	\$139.45
865-T4S04	One-Meter, 4" Wide, Slope # 4 w/ Galv Edge-Rails	B	1	1	\$139.45
865-T4S05	One-Meter, 4" Wide, Slope # 5 w/ Galv Edge-Rails	B	1	1	\$139.45
865-T4S06	One-Meter, 4" Wide, Slope # 6 w/ Galv Edge-Rails	B	1	1	\$139.45
865-T4S07	One-Meter, 4" Wide, Slope # 7 w/ Galv Edge-Rails	B	1	1	\$139.45
865-T4S08	One-Meter, 4" Wide, Slope # 8 w/ Galv Edge-Rails	B	1	1	\$139.45
865-T4S09	One-Meter, 4" Wide, Slope # 9 w/ Galv Edge-Rails	B	1	1	\$139.45
865-T4S10	One-Meter, 4" Wide, Slope # 10 w/ Galv Edge-Rails	B	1	1	\$139.45
865-T4S11	One-Meter, 4" Wide, Slope # 11 w/ Galv Edge-Rails	B	1	1	\$139.45
865-T4S12	One-Meter, 4" Wide, Slope # 12 w/ Galv Edge-Rails	B	1	1	\$139.45



865-T4DI5CL

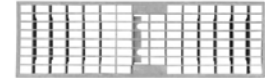

865-T4GS5CM



865-T4GS5CS

Supply

Drainage

Support

Specialties

Appendix

**HydroTec™ TOP System (Cont)**

**Top 100 - 4" Wide**

Item Number	Item Description	Pkg Type	Min Qty	Case Qty	Price
<b>CHANNELS</b>					
865-T4S13	One-Meter, 4" Wide, Slope # 13 w/ Galv Edge-Rails	B	1	1	\$139.45
865-T4S14	One-Meter, 4" Wide, Slope # 14 w/ Galv Edge-Rails	B	1	1	\$139.45
865-T4S15	One-Meter, 4" Wide, Slope # 15 w/ Galv Edge-Rails	B	1	1	\$139.45
865-T4S16	One-Meter, 4" Wide, Slope # 16 w/ Galv Edge-Rails	B	1	1	\$139.45
865-T4S17	One-Meter, 4" Wide, Slope # 17 w/ Galv Edge-Rails	B	1	1	\$139.45
865-T4S18	One-Meter, 4" Wide, Slope # 18 w/ Galv Edge-Rails	B	1	1	\$139.45
865-T4S19	One-Meter, 4" Wide, Slope # 19 w/ Galv Edge-Rails	B	1	1	\$139.45
865-T4S20	One-Meter, 4" Wide, Slope # 20 w/ Galv Edge-Rails	B	1	1	\$139.45
865-T4S21	One-Meter, 4" Wide, Slope # 21 w/ Galv Edge-Rails	B	1	1	\$139.45
865-T4S22	One-Meter, 4" Wide, Slope # 22 w/ Galv Edge-Rails	B	1	1	\$139.45
865-T4S23	One-Meter, 4" Wide, Slope # 23 w/ Galv Edge-Rails	B	1	1	\$139.45
865-T4S24	One-Meter, 4" Wide, Slope # 24 w/ Galv Edge-Rails	B	1	1	\$139.45
865-T4S25	One-Meter, 4" Wide, Slope # 25 w/ Galv Edge-Rails	B	1	1	\$139.45
865-T4S26	One-Meter, 4" Wide, Slope # 26 w/ Galv Edge-Rails	B	1	1	\$139.45
865-T4S27	One-Meter, 4" Wide, Slope # 27 w/ Galv Edge-Rails	B	1	1	\$139.45
865-T4S28	One-Meter, 4" Wide, Slope # 28 w/ Galv Edge-Rails	B	1	1	\$139.45
865-T4S29	One-Meter, 4" Wide, Slope # 29 w/ Galv Edge-Rails	B	1	1	\$139.45
865-T4S30	One-Meter, 4" Wide, Slope # 30 w/ Galv Edge-Rails	B	1	1	\$139.45
<b>LOW-PROFILE CHANNELS</b>					
865-T4LP003	One-Meter, 4" Wide × 3.15" Height, Neutral	B	1	1	\$106.22
865-T4LP0053	Half-Meter, 4" Wide × 3.15" Height, Neutral	B	1	1	\$88.70
865-T4LP00B03	One-Meter, 4" Wide × 3.15" Height, Neutral, Bottom Out	B	1	1	\$197.51
865-T4N00	One-Meter, 4" Wide × 4.33" Height, Neutral	B	1	1	\$139.45
865-T4N005	Half-Meter, 4" Wide × 4.33" Height, Neutral	B	1	1	\$93.76
865-T4N00B	One-Meter, 4" Wide × 4.33" Height, Neutral, Bottom Out	B	1	1	\$195.23
<b>CATCH BASIN</b>					
865-T4CB	Half-Meter, Catch Basin w/ Galv Steel Debris Basket - 6" Outlet	B	1	1	\$284.18



865-T4N10



865-T4N00



865-T4CB

Supply

Drainage

Support

Specialties

Appendix

**HydroTec™ TOP System (Cont)**

**Top 100 - 4" Wide**

Item Number	Item Description	Pkg Type	Min Qty	Case Qty	Price
<b>ACCESSORIES</b>					
865-4BK	Installation Bracket for Maxi/Top 100 Channels	B	1	1	\$44.50
865-4EC	4" Closed End Cap - 2 Piece	B	1	1	\$38.60
865-4LPEC3	4" Closed End Cap For 3.15" Channel	B	1	1	\$27.97
865-4LPEC4	4" Closed End Cap For 4.33" Channel	B	1	1	\$27.97
865-4LR	Grate-Locking Rod For 4" Channels	B	1	1	\$1.63
865-4OC	4" Open End Cap - 2 Piece	B	1	1	\$38.60
865-4PC	4" PVC S&D Pipe Connection	B	1	1	\$13.98
865-4RS	4" Rubber Sleeve / Seal For Bottom Outs	B	1	1	\$51.36
865-SHOVEL	Cleaning Shovel For Mini/Top/Maxi	B	1	1	\$191.97
865-T00L	Grate-Locking Tool	B	1	1	\$36.92
865-T00LP	Grate-Locking Tool For Perf-100 Grates	B	1	1	\$36.92



**HydroTec™ TOP System**

**Top 100 Slot - 4" Wide**

Item Number	Item Description	Pkg Type	Min Qty	Case Qty	Price
<b>SLOT-TOP GRATES - CLASS C - CENTRIC</b>					
865-T4GS5CCS	Half-Meter, Class C, Galvanized Steel, Centric Slot	B	1	1	\$239.12
865-T4GSBCCS	Half-Meter, Class C, Galvanized Steel, Centric Slot For Catch Basin	B	1	1	\$753.68
865-T4GS CCS	One-Meter, Class C, Galvanized Steel, Centric Slot	B	1	1	\$320.24
865-T4SSCBCCS	Half-Meter, Class C, Stnls Steel, Centric Slot For Catch Basin	B	1	1	\$1,196.81
865-T4SSCCS	One-Meter, Class C, Stnls Steel, Centric Slot	B	1	1	\$527.63
<b>SLOT-TOP GRATES - CLASS C - ECCENTRIC</b>					
865-T4GS5CES	Half-Meter, Class C, Galvanized Steel, Eccentric Slot	B	1	1	\$283.75
865-T4GSBCES	Half-Meter, Class C, Galvanized Steel, Eccentric Slot For Catch Basin	B	1	1	\$768.75
865-T4GS CES	One-Meter, Class C, Galvanized Steel, Eccentric Slot	B	1	1	\$352.20
865-T4SS5CES	Half-Meter, Class C, Stnls Steel, Eccentric Slot	B	1	1	\$453.08
865-T4SSBCES	Half-Meter, Class C, Stnls Steel, Eccentric Slot For Catch Basin	B	1	1	\$1,226.95
865-T4SSCES	One-Meter, Class C, Stnls Steel, Eccentric Slot	B	1	1	\$562.60
<b>SLOT-TOP CHANNELS</b>					
865-ST4N10	One-Meter, 4" Wide x 5.51" Height, Neutral, No Edge-Rails	B	1	1	\$93.17
865-ST4N105	Half-Meter, 4" Wide x 5.51" Height, Neutral, No Edge-Rails	B	1	1	\$78.05
865-ST4N105S	Half-Meter, 4" Wide x 5.51" Height, Neutral, Side Out, No Edge-Rails	B	1	1	\$97.58
865-ST4N10B	One-Meter, 4" Wide x 5.51" Height, Neutral, Bottom Out, No Edge-Rails	B	1	1	\$188.09
<b>SLOT-TOP CATCH BASIN</b>					
865-ST4CB	Catch Basin w/ Galvanized Basket, No Edge-Rails	B	1	1	\$274.39



Supply

Drainage

Support

Specialties

Appendix

## HydroTec™ TOP System (Cont)

### Top 100 Slot - 4" Wide

Item Number	Item Description	Pkg Type	Min Qty	Case Qty	Price
<b>ACCESSORIES</b>					
865-4EC	4" Closed End Cap - 2 Piece	B	1	1	\$38.60
865-4LPEC3	4" Closed End Cap For 3.15" Channel	B	1	1	\$27.97
865-4LPEC4	4" Closed End Cap For 4.33" Channel	B	1	1	\$27.97
865-4OC	4" Open End Cap - 2 Piece	B	1	1	\$38.60
865-4PC	4" PVC S&D Pipe Connection	B	1	1	\$13.98
865-4RS	4" Rubber Sleeve / Seal For Bottom Outs	B	1	1	\$51.36

## HydroTec™ TOP System

### Top 150 - 6" Wide

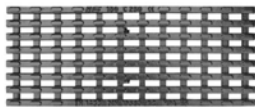

865-T6DI5CL



865-T6GS5CM

Item Number	Item Description	Pkg Type	Min Qty	Case Qty	Price
<b>GRATES</b>					
865-T6DI5CL	Half-Meter, Class C, Ductile Iron, Long Slot, ADA	B	1	1	\$76.77
865-T6GS5CM	Half-Meter, Class C, Galvanized Steel, Mesh	B	1	1	\$108.34
865-T6GSCM	One-Meter, Class C, Galvanized Steel, Mesh	B	1	1	\$149.79
<b>CHANNELS</b>					
865-T6N00	One-Meter, Neutral, 6" Wide, 8.27" Height	B	1	1	\$142.23
865-T6N005	Half-Meter, Neutral, 6" Wide, 8.27" Height	B	1	1	\$90.56
865-T6N005S	Half-Meter, Neutral, 6" Wide, 8.27" Height, Side Out	B	1	1	\$119.27
865-T6N00B	One-Meter, Neutral, 6" Wide, 8.27" Height, Bottom Out	B	1	1	\$235.07
865-T6N05	One-Meter, Neutral, 6" Wide, 10.24" Height	B	1	1	\$142.23
865-T6N055	Half-Meter, Neutral, 6" Wide, 10.24" Height	B	1	1	\$90.56
865-T6N055S	Half-Meter, Neutral, 6" Wide, 10.24" Height, Side Out	B	1	1	\$119.27
865-T6N05B	One-Meter, Neutral, 6" Wide, 10.24" Height, Bottom Out	B	1	1	\$235.07
865-T6N10	One-Meter, Neutral, 6" Wide, 12.20" Height	B	1	1	\$142.23
865-T6N105	Half-Meter, Neutral, 6" Wide, 12.20" Height	B	1	1	\$90.56
865-T6N105S	Half-Meter, Neutral, 6" Wide, 12.20" Height, Side Out	B	1	1	\$119.27
865-T6N10B	One-Meter, Neutral, 6" Wide, 12.20" Height, Bottom Out	B	1	1	\$235.07
865-T6S01	One-Meter, Slope # 1, 6" Wide w/ Galv Edge-Rails	B	1	1	\$142.23
865-T6S02	One-Meter, Slope # 2, 6" Wide w/ Galv Edge-Rails	B	1	1	\$142.23
865-T6S03	One-Meter, Slope # 3, 6" Wide w/ Galv Edge-Rails	B	1	1	\$142.23
865-T6S04	One-Meter, Slope # 4, 6" Wide w/ Galv Edge-Rails	B	1	1	\$142.23
865-T6S05	One-Meter, Slope # 5, 6" Wide w/ Galv Edge-Rails	B	1	1	\$142.23
865-T6S06	One-Meter, Slope # 6, 6" Wide w/ Galv Edge-Rails	B	1	1	\$142.23
865-T6S07	One-Meter, Slope # 7, 6" Wide w/ Galv Edge-Rails	B	1	1	\$142.23
865-T6S08	One-Meter, Slope # 8, 6" Wide w/ Galv Edge-Rails	B	1	1	\$142.23
865-T6S09	One-Meter, Slope # 9, 6" Wide w/ Galv Edge-Rails	B	1	1	\$142.23

Supply

Drainage

Support

Specialties

Appendix



**HydroTec™ TOP System (Cont)**

**Top 150 - 6" Wide**

Item Number	Item Description	Pkg Type	Min Qty	Case Qty	Price
<b>CHANNELS</b>					
865-T6S10	One-Meter, Slope # 10, 6" Wide w/ Galv Edge-Rails	B	1	1	\$142.23
<b>CATCH BASIN</b>					
865-T6CB	Half-Meter, Catch Basin w/ Galv Steel Debris Basket - 6" Outlet	B	1	1	\$391.89
<b>ACCESSORIES</b>					
865-6LR	Grate-Locking Rod For 6" Channels	B	1	1	\$2.19
865-6PC	PVC S&D Pipe Connection for 6" Outs	B	1	1	\$25.72
865-6RS	Rubber Sleeve/Seal For 6" Bottom Outs	B	1	1	\$61.52
865-6UC	6" Universal End Cap - Open & Closed	Bl	1	20	\$46.73
865-SHOVEL	Cleaning Shovel For Mini/Top/Maxi	B	1	1	\$191.97
865-TOOL	Grate-Locking Tool	B	1	1	\$36.92



865-T6N00



865-6UC

**HydroTec™ TOP System**

**Top 200 - 8" Wide**

Item Number	Item Description	Pkg Type	Min Qty	Case Qty	Price
<b>GRATES</b>					
865-T8DI5CL	Half-Meter, Class C, Ductile Iron, Long Slot, ADA	B	1	1	\$129.12
865-T8GS5CM	Half-Meter, Class C, Galvanized Steel, Mesh	B	1	1	\$167.69
865-T8GSCM	One-Meter, Class C, Galvanized Steel, Mesh	B	1	1	\$221.96
<b>CHANNELS</b>					
865-T8N00	One-Meter, 8" Wide, Neutral w/ Galv Edge-Rails	B	1	1	\$210.94
865-T8N005	Half-Meter, 8" Wide, Neutral w/ Galv Edge-Rails	B	1	1	\$146.49
865-T8N005S	Half-Meter, 8" Wide, Neutral, Side Out w/ Galv Edge-Rails	B	1	1	\$172.53
865-T8N00B	One-Meter, 8" Wide, Neutral, Bottom Out w/ Galv Edge-Rails	B	1	1	\$291.75
<b>CATCH BASIN</b>					
865-T8CB	Catch Basin w/ Galvanized Debris Basket	B	1	1	\$527.34
<b>ACCESSORIES</b>					
865-8LR	Grate-Locking Rod For 8" Channels	B	1	1	\$2.04
865-8PC	PVC S&D Pipe Connection for 8" Outs	B	1	1	\$38.14
865-8RS	Rubber Sleeve/Seal For 8" Bottom Outs	B	1	1	\$78.31
865-8UC	Universal End Cap - Open & Closed	Bl	1	20	\$53.39
865-SHOVEL	Cleaning Shovel For Mini/Top/Maxi	B	1	1	\$191.97
865-TOOL	Grate-Locking Tool	B	1	1	\$36.92

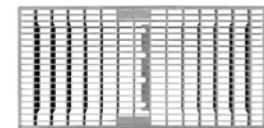

865-T8GS5CM



865-T8N00



865-TOOL

Supply

Drainage

Support

Specialties

Appendix



# HydroBlock™ System

**HydroBlock™ 100**

**HydroBlock™ 150**

**HydroBlock™ 200**

**HydroBlock™ 300**

One-piece ductile iron channel and grate system designed for ultimate durability and rattle-free operation.

Sections join together easily with no fasteners - joints are water-tight and anti-torque. One-piece design is perfect for heavy loads and high-traffic areas.

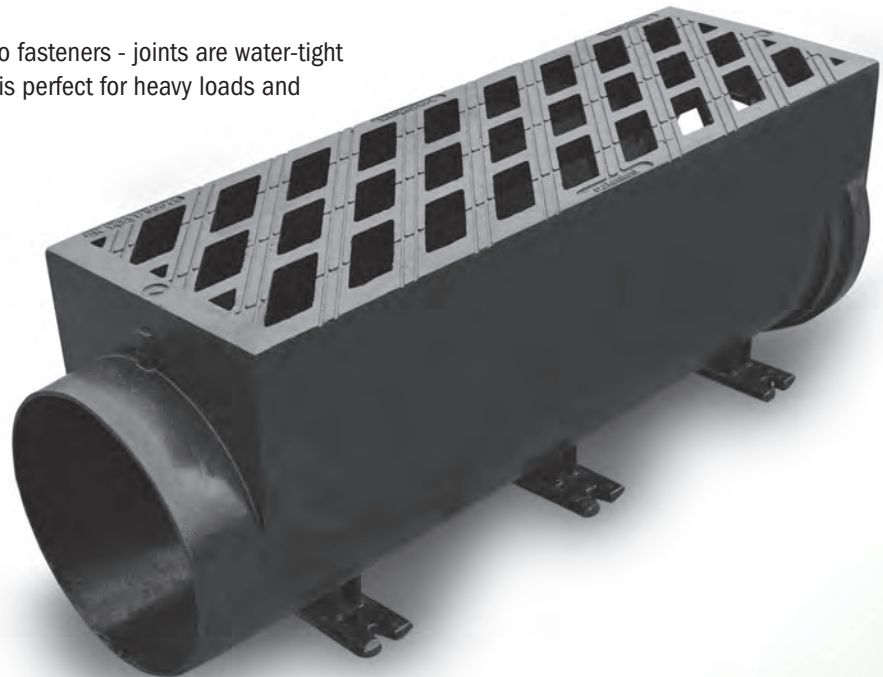



**HydroBlock™ 100**

Item Number	Item Description	Pkg Type	Min Qty	Case Qty	Price
865-HB4005BFA	Half-Meter, 4" Wide, Bottom Out w/ Ductile Iron Removable Grate	B	1	1	\$479.89
865-HB4005HSFA	Half-Meter, 4" Wide, End Out w/ Ductile Iron Removable Grate	B	1	1	\$479.89
865-HB4005SFA	Half-Meter, 4" Wide, Right Side Out w/ Ductile Iron Removable Grate	B	1	1	\$479.89
865-HB400FA	One-Meter, 4" Wide w/ Ductile Iron Grate	B	1	1	\$472.01
865-HB4CBFA	Catch Basin w/ Removable Ductile Iron Grate	B	1	1	\$933.50
<b>ACCESSORIES</b>					
865-HB4EC	Closed End Cap For Socket End	B	1	1	\$18.75
865-HB4INSB	Installation Aid Tool	B	1	1	\$316.52
865-HB4OC	Closed End Cap For Spigot End	B	1	1	\$18.75



865-HB400FA



865-HB4EC

**HydroBlock™ 150**

Item Number	Item Description	Pkg Type	Min Qty	Case Qty	Price
865-HB6005BFA	Half-Meter, 6" Wide, Bottom Out w/Ductile Iron Removable Grate	B	1	1	\$590.58
865-HB6005HSFA	Half-Meter, 6" Wide, Left/Right/End Out w/Ductile Iron Removable Grate	B	1	1	\$590.58
865-HB600FA	One-Meter, 6" Wide w/Ductile Iron Grate	B	1	1	\$711.28
865-HB6CBFA	Catch Basin w/ Removable Ductile Iron Grate	B	1	1	\$1,072.90
<b>ADA COMPLIANT</b>					
865-HB6ADA005BFA	Half-Meter, 6" Wide, Bottom Out w/ ADA Ductile Iron Removable Grate	B	1	1	\$638.35
865-HB6ADA005FA	Half-Meter, 6" Wide, w/ ADA Ductile Iron Removable Grate	B	1	1	\$638.35
865-HB6ADA005HSFA	Half-Meter, 6" Wide, Left/Right/End Out w/ ADA Ductile Iron Removable Grate	B	1	1	\$638.35
865-HB6ADA00FA	One-Meter, 6" Wide w/ ADA Ductile Iron Grate	B	1	1	\$770.99
865-HB6ADACBFA	Catch Basin w/ Removable ADA Ductile Iron Grate	B	1	1	\$1,156.54
<b>ACCESSORIES</b>					
865-HB6AINSB	Installation Aid Tool for ADA Pattern	B	1	1	\$316.52
865-HB6EC	Closed End Cap For Socket End	B	1	1	\$25.28
865-HB6INSB	Installation Aid Tool	B	1	1	\$316.52
865-HB6OC	Closed End Cap For Spigot End	B	1	1	\$25.28



865-HB600FA



865-HB6ADA005HSFA

**HydroBlock™ 200**

Item Number	Item Description	Pkg Type	Min Qty	Case Qty	Price
865-HB8005BFA	Half-Meter, 8" Wide, Bottom Out w/ Ductile Iron Removable Grate	B	1	1	\$822.51
865-HB8005SFA	Half-Meter, 8" Wide, Left/Right Out w/ Ductile Iron Removable Grate	B	1	1	\$822.51
865-HB800FA	One-Meter, 8" Wide w/ Ductile Iron Grate	B	1	1	\$1,066.41
865-HB8CBFA	Catch Basin w/ Removable Ductile Iron Grate	B	1	1	\$1,188.28



865-HB800FA

Supply

Drainage

Support

Specialties

Appendix

**HydroBlock™ 200 (Cont)**

Item Number	Item Description	Pkg Type	Min Qty	Case Qty	Price
<b>ADA COMPLIANT</b>					
865-HB8ADA005BFA	Half-Meter, 8" Wide, Bottom Out w/ ADA Ductile Iron Removable Grate	B	1	1	\$888.18
865-HB8ADA005SFA	Half-Meter, 8" Wide, Left/Right Out w/ ADA Ductile Iron Removable Grate	B	1	1	\$888.18
865-HB8ADA00FA	One-Meter, 8" Wide w/ ADA Ductile Iron Grate	B	1	1	\$1,156.01
865-HB8ADACBFA	Catch Basin w/ Removable ADA Ductile Iron Grate	B	1	1	\$1,283.83
<b>ACCESSORIES</b>					
865-HB6AINSB	Installation Aid Tool for ADA Pattern	B	1	1	\$316.52
865-HB6INSB	Installation Aid Tool	B	1	1	\$316.52
865-HB8EC	Closed End Cap For Socket End	B	1	1	\$23.44
865-HB8OC	Closed End Cap For Spigot End	B	1	1	\$23.44

**HydroBlock™ 300**

Item Number	Item Description	Pkg Type	Min Qty	Case Qty	Price
865-HB12005BFA	Three-Quarter-Meter, 12" Wide, Bottom Out w/ Ductile Removable Grate	B	1	1	\$2,059.16
865-HB1200FA	One-Meter, 12" Wide w/ Ductile Iron Grate	B	1	1	\$2,059.16
<b>ADA COMPLIANT</b>					
865-HB12ADA005BFA	Three-Quarter-Meter, 12" Wide, Bottom Out w/ ADA Ductile Removable Grate	B	1	1	\$2,226.35
865-HB12ADA005FA	Three-Quarter-Meter, 12" Wide w/ ADA Ductile Iron Grate	B	1	1	\$2,226.35
<b>865-HB12ADA005SFA</b>	<b>Three Quarter-Meter, 12" Wide, Left/Right Side Out w/ Ada Ductile Iron Removable Grate</b>	B	1	1	\$2,226.35
865-HB12ADA00FA	One-Meter, 12" Wide w/ ADA Ductile Iron Grate	B	1	1	\$2,226.35
<b>ACCESSORIES</b>					
865-12PC	12" PVC S&D Pipe Connector	B	1	1	\$87.85
865-HB12EC	Closed End Cap For Socket End	B	1	1	\$156.61
865-HB12OC	Closed End Cap For Spigot End	B	1	1	\$156.61
865-HB12S	Debris Bucket For Vertical Out	B	1	1	\$339.96
865-HB6AINSB	Installation Aid Tool for ADA Pattern	B	1	1	\$316.52
865-HB6INSB	Installation Aid Tool	B	1	1	\$316.52



865-HB8OC



865-HB1200FA



865-HB12ADA005BFA



865-HB12OC

Supply

Drainage

Support

Specialties

Appendix

# HydroLine™ System

The HydroLine™ is a unique, ultra-low-profile system designed for fast/easy installations or height-restricted applications. Rib-design channels made from ductile iron or aluminum lock into concrete slab and stand up to heavy-duty traffic.

The system is low-maintenance and perfect for covered parking areas or thresholds to prevent surface water cross-over.







HydroLine™ System

Item Number	Item Description	Pkg Type	Min Qty	Case Qty	Price
<b>DUCTILE IRON CHANNELS</b>					
865-HL4L	4-1/2" Wide Channel - Corner Section, 2 Pcs	B	1	1	\$668.15
865-HL4N005BF	Half-Meter, 4-1/2" Wide Channel, Neutral w/ Out	B	1	1	\$159.51
865-HL4N005K	Half-Meter, 4-1/2" Wide Channel, Neutral w/ Curb End	B	1	1	\$171.05
865-HL4N00CSF	One-Meter, 4-1/2" Wide Channel, Neutral w/ Cleaning End	B	1	1	\$250.65
865-HL4N00F	One-Meter, 4-1/2" Wide Channel, Neutral	B	1	1	\$174.48
<b>POWDER-COATED ALUMINUM CHANNELS</b>					
865-HLP4AB	5" Wide Channel - Bottom Outlet Section	B	1	1	\$245.19
865-HLP4C	5" Wide Channel - Corner Section, 2 Pcs	B	1	1	\$692.15
865-HLP4N00F1M	One-Meter, 5" Wide Channel, Neutral	B	1	1	\$512.91
865-HLP4N00F3M	Three-Meter, 5" Wide Channel, Neutral	B	1	1	\$760.39
865-HLP4T	5" Wide Channel - Tee Section, 3 Pcs	B	1	1	\$1,039.40
865-HLP4X	5" Wide Channel - Cross Section, 4 Pcs	B	1	1	\$1,384.09
<b>ACCESSORIES</b>					
865-HLAC	One-Meter Installation Cover For Aluminum Channels	B	1	1	\$191.76
865-HLCE	Connection Element For Iron Channels	B	1	1	\$39.36
865-HLDC	One-Meter Installation Cover For Iron Channels	B	1	1	\$191.76
865-HLEC	End Wall For Iron Channels	B	1	1	\$39.36
865-HLISC	Installation Bracket For Iron Channels	B	1	1	\$39.36
865-HLPCE	Connection Element For Aluminum Channels	B	1	1	\$39.36
865-HLPEC	End Wall For Aluminum Channels	B	1	1	\$39.36
865-HLPED	Installation Pedestal For Iron Channels	B	1	1	\$207.15
865-HLPISC	Installation Bracket For Aluminum Channels	B	1	1	\$39.36
865-HLPPED	Installation Pedestal For Aluminum Channels	B	1	1	\$223.73
865-RAKE	Cleaning Rake For Iron Channels	B	1	1	\$223.72
865-RAKEP	Cleaning Rake For Aluminum Channels	B	1	1	\$264.39



865-HL4N005BF

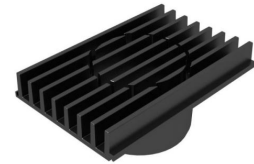

865-HLP4AB



865-RAKE

Supply

Drainage

Support

Specialties

Appendix



# **Residential Drainage**

**Shower Drains**

**Floor Drains**

**Closet Flanges**

**Backwater Valves**

**Air Admittance Valves**

**Accessories**

# Residential Drainage

## Shower Drains

Shower drains designed for tile floors and prefabricated floors and modules. PVC, ABS, and cast iron connections available. Designed in accordance with *ASME A112.18.2/CSA B125.2 Standard for Plumbing Waste Fittings*.

## Floor Drains

Floor drains for residential and other non-commercial applications. PVC, ABS and cast iron connections available. Designed in accordance with *ASME A112.6.3 Standard for Floor and Trench Drains*.

## Closet Flanges

Closet flanges for standard, floor mounted toilets. Spacer and accessory products for repair and replacement applications. Solvent weld connections designed in accordance with ASTM D2665 (PVC) / ASTM D2661 (ABS)

## Backwater Valves

One-way valves designed to prevent back flow of waste lines in both shallow and deep-bury applications. PVC and ABS connections. Designed in accordance with *ASME A112.14.1 Standard for Backwater Valves*.

## Air Admittance Valves

One-way valves designed to allow air into vent lines for drainage systems and prevent sewer gas from entering the living space. PVC and ABS connections available. Designed in accordance with ANSI/ASSE 1050 and 1051.

## Accessories

Saddle tee fittings, condensate traps and other residential accessory items.

# Shower Drains

**Shower Pan Drains**

**StreamLine™ Linear Drains**

**Shower Module Drains**

**Freestanding Tub Drain**

**Replacement Strainers**

A wide variety of shower drains available for tile floors or prefabricated shower floors and modules.

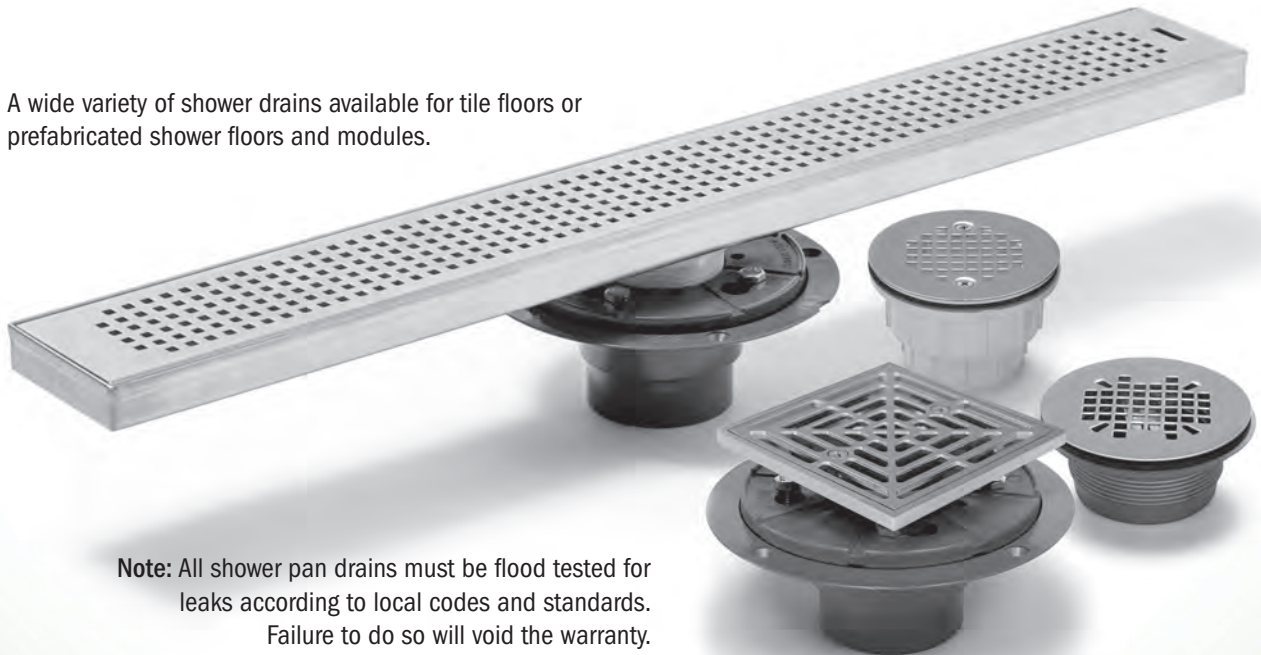

**Note:** All shower pan drains must be flood tested for leaks according to local codes and standards. Failure to do so will void the warranty.



**821-2P**  
Page 407



**821-T2P**  
Page 407



**821-270PQ**  
Page 407



**821-T270PQ**  
Page 407



**821-200PNQ**  
Page 408



**821-T200PNQ**  
Page 408

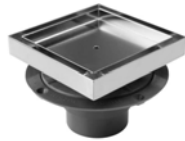

**821-2PTQ**  
Page 413



**821-2INS**  
Page 416



**863-435CQ**  
Page 415



**823-TX26WP**  
Page 417



**823-T2A36V**  
Page 418



**825-2P**  
Page 419



**827-2B**  
Page 419



**828-2**  
Page 419



**827-2J**  
Page 420



**826-2P**  
Page 420



**827-2SN**  
Page



**821-2SCRPK1**  
Page 422

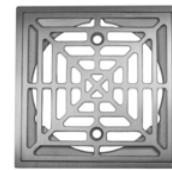

**821-2SKQPK1**  
Page 423

**Screw-On Stainless Steel Strainer**

**2" PVC/ABS - Sch.40 Hub Connection**

Item Number	Item Description	Pkg Type	Min Qty	Case Qty	Price
<b>ROUND STRAINER - NO INSERTS</b>					
821-2A	ABS Hub - 4-1/4" Rnd Strainer	BI	20	20	\$13.65
821-2APK	ABS Hub - 4-1/4" Rnd Strainer	CI	8	8	\$14.65
821-2P	PVC Hub - 4-1/4" Rnd Strainer	BI	20	20	\$13.65
821-2PPK	PVC Hub - 4-1/4" Rnd Strainer	CI	8	8	\$14.65
821-T2A	ABS Hub - 4-1/4" Rnd Strainer w/ DoubleDuty™ Test Plug	BI	1	10	\$13.65
821-T2P	PVC Hub - 4-1/4" Rnd Strainer w/ DoubleDuty™ Test Plug	BI	1	10	\$13.65
<b>ROUND STRAINER WITH BRASS INSERTS</b>					
821-200A	ABS Hub - 4-1/4" Rnd Strainer	BI	20	20	\$14.36
821-200P	PVC Hub - 4-1/4" Rnd Strainer	BI	20	20	\$14.36
821-T200A	ABS Hub - 4-1/4" Rnd Strainer w/ DoubleDuty™ Test Plug	BI	10	10	\$14.36
821-T200P	PVC Hub - 4-1/4" Rnd Strainer w/ DoubleDuty™ Test Plug	BI	10	10	\$14.36
<b>COMPONENT ITEMS</b>					
821-2LSPC	4-1/4" Rnd Strainer	BI	10	10	\$5.77
821-2LSPCI	4-1/4" Rnd Strainer	BI	10	10	\$6.54
821-HA2	2" ABS Hub - Base & Collar Only	BI	25	25	\$8.13
821-HP2	2" PVC Hub - Base & Collar Only	BI	25	25	\$8.13
821-THA2	2" ABS Hub - Base & Collar Only w/ DoubleDuty™ Test Plug	BI	25	25	\$8.13
821-THP2	2" PVC Hub - Base & Collar Only w/ DoubleDuty™ Test Plug	BI	25	25	\$8.13
<b>ACCESSORIES</b>					
821-EX2	Threaded Extension Adapter - 2-3/8" Min - 4-3/4" Max	BI	1	10	\$4.94
821-H	Hair Catcher	B	10	100	\$0.75
821-TP	Test Plug For 821 Shower Drain	BI	10	10	\$3.55
835-2	Trapshield™ For 2" Drain Outlet	BI	1	50	\$56.31



821-2A



821-T200P



821-HP2

**Snap-In Stainless Steel Strainer**

**2" PVC/ABS - Sch.40 Hub Connection**

Item Number	Item Description	Pkg Type	Min Qty	Case Qty	Price
<b>ROUND STRAINER</b>					
821-270A	ABS Hub - 4-1/4" Rnd Strainer	BI	20	20	\$13.65
821-270P	PVC Hub - 4-1/4" Rnd Strainer	BI	20	20	\$13.65
821-T270A	ABS Hub - 4-1/4" Rnd Strainer w/ DoubleDuty™ Test Plug	BI	1	10	\$13.65
821-T270P	PVC Hub - 4-1/4" Rnd Strainer w/ DoubleDuty™ Test Plug	BI	1	10	\$13.65
<b>SQUARE STRAINER</b>					
821-270AQ	ABS Hub - 4-1/4" Sqr Strainer	BI	20	20	\$21.65
821-270PQ	PVC Hub - 4-1/4" Sqr Strainer	BI	20	20	\$21.65
821-T270AQ	ABS Hub - 4-1/4" Sqr Strainer w/ DoubleDuty™ Test Plug	BI	1	10	\$21.65
821-T270PQ	PVC Hub - 4-1/4" Sqr Strainer w/ DoubleDuty™ Test Plug	BI	1	10	\$21.65



821-270P



821-270PQ

Supply

Drainage

Support

Specialties

Appendix



821-2A



821-EX2

### Snap-In Stainless Steel Strainer (Cont)

#### 2" PVC/ABS - Sch.40 Hub Connection

Item Number	Item Description	Pkg Type	Min Qty	Case Qty	Price
<b>COMPONENT ITEMS</b>					
821-2LSNQ	4-1/4" Sqr Strainer	BI	10	10	\$12.39
821-2LSPN	4-1/4" Rnd Strainer	BI	10	10	\$5.77
821-HA2	2" ABS Hub - Base & Collar Only	BI	25	25	\$8.13
821-HP2	2" PVC Hub - Base & Collar Only	BI	25	25	\$8.13
821-THA2	2" ABS Hub - Base & Collar Only w/ DoubleDuty™ Test Plug	BI	25	25	\$8.13
821-THP2	2" PVC Hub - Base & Collar Only w/ DoubleDuty™ Test Plug	BI	25	25	\$8.13
<b>ACCESSORIES</b>					
821-2QARB	Round-to-Square Strainer & Adapter Kit - Oil-Rubbed Bronze Finish Strainer	CI	5	5	\$20.25
821-2QAS	Round-to-Square Strainer & Adapter Kit - Stnls Steel Finish Strainer	CI	5	5	\$7.06
821-EX2	Threaded Extension Adapter - 2-3/8" Min - 4-3/4" Max	BI	1	10	\$4.94
821-H	Hair Catcher	B	10	100	\$0.75
821-TP	Test Plug For 821 Shower Drain	BI	10	10	\$3.55
835-2	Trapshield™ For 2" Drain Outlet	BI	1	50	\$56.31

### Deluxe Nickel-Bronze Ring & Strainer

#### 2" PVC/ABS - Sch.40 Hub Connection



821-T200ANR



821-200PNQ

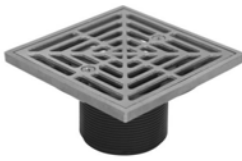

821-2LNQ

Item Number	Item Description	Pkg Type	Min Qty	Case Qty	Price
<b>ROUND RING &amp; STRAINER</b>					
821-200ANR	ABS Hub - 4-1/2" Rnd Strainer	BI	5	5	\$53.37
821-200PNR	PVC Hub - 4-1/2" Rnd Strainer	BI	5	5	\$53.37
821-T200ANR	ABS Hub - 4-1/2" Rnd Strainer w/ DoubleDuty™ Test Plug	BI	5	5	\$53.37
821-T200PNR	PVC Hub - 4-1/2" Rnd Strainer w/ DoubleDuty™ Test Plug	BI	5	5	\$53.37
<b>SQUARE RING &amp; STRAINER</b>					
821-200ANQ	ABS Hub - 4-1/2" Sqr Strainer	BI	1	5	\$67.61
821-200PNQ	PVC Hub - 4-1/2" Sqr Strainer	BI	1	5	\$67.61
821-T200ANQ	ABS Hub - 4-1/2" Sqr Strainer w/ DoubleDuty™ Test Plug	BI	1	5	\$67.61
821-T200PNQ	PVC Hub - 4-1/2" Sqr Strainer w/ DoubleDuty™ Test Plug	BI	5	5	\$67.61
<b>COMPONENT ITEMS</b>					
821-2LNQ	4-1/2" Sqr Strainer	BI	1	5	\$59.47
821-2LNR	4-1/4" Rnd Strainer	BI	1	5	\$45.23
821-MHA2	2" ABS Hub - Base & Collar Only	BI	25	25	\$8.13
821-MHP2	2" PVC Hub - Base & Collar Only	BI	25	25	\$8.13
821-TMHA2	2" ABS Hub - Base & Collar Only w/ DoubleDuty™ Test Plug	BI	25	25	\$8.13
821-TMHP2	2" PVC Hub - Base & Collar Only w/ DoubleDuty™ Test Plug	BI	25	25	\$8.13



**Deluxe Nickel-Bronze Ring & Strainer (Cont)**

**2" PVC/ABS - Sch.40 Hub Connection**

Item Number	Item Description	Pkg Type	Min Qty	Case Qty	Price
<b>ACCESSORIES</b>					
821-EX2	Threaded Extension Adapter - 2-3/8" Min - 4-3/4" Max	BI	1	10	\$4.94
821-H	Hair Catcher	B	10	100	\$0.75
821-TP	Test Plug For 821 Shower Drain	BI	10	10	\$3.55
835-2	Trapshield™ For 2" Drain Outlet	BI	1	50	\$56.31



821-EX2

**Deluxe Polished Stainless Ring & Strainer**

**2" PVC/ABS - Sch.40 Hub Connection**

Item Number	Item Description	Pkg Type	Min Qty	Case Qty	Price
<b>ROUND RING &amp; STRAINER</b>					
821-200ACR	ABS Hub - 4-1/2" Rnd Strainer	BI	5	5	\$67.61
821-200PCR	PVC Hub - 4-1/2" Rnd Strainer	BI	5	5	\$67.61
<b>821-T200ACR</b>	ABS Hub - 4-1/2" Rnd Strainer w/ DoubleDuty™ Test Plug	BI	5	5	\$67.61
821-T200PCR	PVC Hub - 4-1/2" Rnd Strainer w/ DoubleDuty™ Test Plug	BI	5	5	\$67.61
<b>SQUARE RING &amp; STRAINER</b>					
821-200ACQ	ABS Hub - 4-1/2" Sqr Strainer	BI	1	5	\$81.83
821-200PCQ	PVC Hub - 4-1/2" Sqr Strainer	BI	1	5	\$81.83
821-T200ACQ	ABS Hub - 4-1/2" Sqr Strainer w/ DoubleDuty™ Test Plug	BI	1	5	\$81.83
821-T200PCQ	PVC Hub - 4-1/2" Sqr Strainer w/ DoubleDuty™ Test Plug	BI	1	5	\$81.83
<b>COMPONENT ITEMS</b>					
821-2LCQ	4-1/2" Sqr Strainer	BI	1	5	\$73.69
821-2LCR	4-1/2" Rnd Strainer	BI	1	5	\$59.47
821-MHA2	2" ABS Hub - Base & Collar Only	BI	25	25	\$8.13
821-MHP2	2" PVC Hub - Base & Collar Only	BI	25	25	\$8.13
<b>821-TMHA2</b>	2" ABS Hub - Base & Collar Only w/ DoubleDuty™ Test Plug	BI	25	25	\$8.13
<b>821-TMHP2</b>	2" PVC Hub - Base & Collar Only w/ DoubleDuty™ Test Plug	BI	25	25	\$8.13
<b>ACCESSORIES</b>					
821-EX2	Threaded Extension Adapter - 2-3/8" Min - 4-3/4" Max	BI	1	10	\$4.94
821-H	Hair Catcher	B	10	100	\$0.75
821-TP	Test Plug For 821 Shower Drain	BI	10	10	\$3.55



821-200ACR

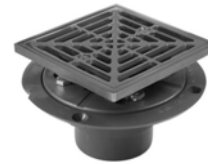

821-200PCQ

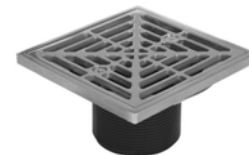

821-2LCQ



821-EX2

Supply

Drainage

Support

Specialties

Appendix



821-200AKR



821-200PKQ

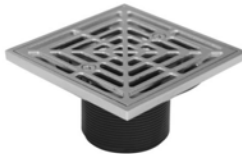

821-2LKQ



821-EX2



821-200PSQ



821-200ASQ

## Deluxe Satin Nickel Finish Ring & Strainer

### 2" PVC/ABS - Sch.40 Hub Connection

Item Number	Item Description	Pkg Type	Min Qty	Case Qty	Price
<b>ROUND RING &amp; STRAINER</b>					
821-200AKR	ABS Hub - 4-1/2" Rnd Strainer	BI	5	5	\$67.61
821-200PKR	PVC Hub - 4-1/2" Rnd Strainer	BI	5	5	\$67.61
821-T200AKR	ABS Hub - 4-1/2" Rnd Strainer w/ DoubleDuty™ Test Plug	BI	1	5	\$67.61
821-T200PKR	PVC Hub - 4-1/2" Rnd Strainer w/ DoubleDuty™ Test Plug	BI	5	5	\$67.61
<b>SQUARE RING &amp; STRAINER</b>					
821-200AKQ	ABS Hub - 4-1/2" Sqr Strainer	BI	1	5	\$81.83
821-200PKQ	PVC Hub - 4-1/2" Sqr Strainer	BI	1	5	\$81.83
821-T200AKQ	ABS Hub - 4-1/2" Sqr Strainer w/ DoubleDuty™ Test Plug	BI	1	5	\$81.83
821-T200PKQ	PVC Hub - 4-1/2" Sqr Strainer w/ DoubleDuty™ Test Plug	BI	1	5	\$81.83
<b>COMPONENT ITEMS</b>					
821-2LKQ	4-1/2" Sqr Strainer	BI	1	5	\$73.69
<b>821-2LKR</b>	4-1/2" Rnd Strainer	BI	1	5	\$59.47
821-MHA2	2" ABS Hub - Base & Collar Only	BI	25	25	\$8.13
821-MHP2	2" PVC Hub - Base & Collar Only	BI	25	25	\$8.13
<b>821-TMHA2</b>	2" ABS Hub - Base & Collar Only w/ DoubleDuty™ Test Plug	BI	25	25	\$8.13
<b>821-TMHP2</b>	2" PVC Hub - Base & Collar Only w/ DoubleDuty™ Test Plug	BI	25	25	\$8.13
<b>ACCESSORIES</b>					
821-EX2	Threaded Extension Adapter - 2-3/8" Min - 4-3/4" Max	BI	1	10	\$4.94
821-H	Hair Catcher	B	10	100	\$0.75
821-TP	Test Plug For 821 Shower Drain	BI	10	10	\$3.55
835-2	Trapshield™ For 2" Drain Outlet	BI	1	50	\$56.31

## Deluxe Matte Stainless Ring & Strainer

### 2" PVC/ABS - Sch.40 Hub Connection

Item Number	Item Description	Pkg Type	Min Qty	Case Qty	Price
<b>ROUND RING &amp; STRAINER</b>					
821-200ASR	ABS Hub - 4-1/2" Rnd Strainer	BI	5	5	\$53.37
821-200PSR	PVC Hub - 4-1/2" Rnd Strainer	BI	5	5	\$53.37
821-T200ASR	ABS Hub - 4-1/2" Rnd Strainer w/ DoubleDuty™ Test Plug	BI	5	5	\$53.37
821-T200PSR	PVC Hub - 4-1/2" Rnd Strainer w/ DoubleDuty™ Test Plug	BI	5	5	\$53.37
<b>SQUARE RING &amp; STRAINER</b>					
821-200ASQ	ABS Hub - 4-1/2" Sqr Strainer	BI	1	5	\$67.61
821-200PSQ	PVC Hub - 4-1/2" Sqr Strainer	BI	1	5	\$67.61
821-T200ASQ	ABS Hub - 4-1/2" Sqr Strainer w/ DoubleDuty™ Test Plug	BI	1	5	\$67.61
821-T200PSQ	PVC Hub - 4-1/2" Sqr Strainer w/ DoubleDuty™ Test Plug	BI	1	5	\$67.61

## Deluxe Matte Stainless Ring & Strainer (Cont)

### 2" PVC/ABS - Sch.40 Hub Connection

Item Number	Item Description	Pkg Type	Min Qty	Case Qty	Price
<b>COMPONENT ITEMS</b>					
821-2LSQ	4-1/2" Sqr Strainer	Bl	1	5	\$59.47
821-2LSR	4-1/2" Rnd Strainer	Bl	1	5	\$45.23
821-MHA2	2" ABS Hub - Base & Collar Only	Bl	25	25	\$8.13
821-MHP2	2" PVC Hub - Base & Collar Only	Bl	25	25	\$8.13
<b>821-TMHA2</b>	2" ABS Hub - Base & Collar Only w/ DoubleDuty™ Test Plug	Bl	25	25	\$8.13
<b>821-TMHP2</b>	2" PVC Hub - Base & Collar Only w/ DoubleDuty™ Test Plug	Bl	25	25	\$8.13
<b>ACCESSORIES</b>					
821-EX2	Threaded Extension Adapter - 2-3/8" Min - 4-3/4" Max	Bl	1	10	\$4.94
821-H	Hair Catcher	B	10	100	\$0.75
821-T2P	PVC Hub - 4-1/4" Rnd Strainer w/ DoubleDuty™ Test Plug	Bl	1	10	\$13.65
835-2	Trapshield™ For 2" Drain Outlet	Bl	1	50	\$56.31



821-EX2

## Deluxe Oil-Rubbed Bronze Finish Ring & Strainer

### 2" PVC/ABS - Sch.40 Hub Connection

Item Number	Item Description	Pkg Type	Min Qty	Case Qty	Price
<b>ROUND RING &amp; STRAINER</b>					
821-200ARBR	ABS Hub - 4-1/2" Rnd Strainer	Bl	1	5	\$96.07
821-200PRBR	PVC Hub - 4-1/2" Rnd Strainer	Bl	1	5	\$96.07
821-T200ARBR	ABS Hub - 4-1/2" Rnd Strainer w/ DoubleDuty™ Test Plug	Bl	1	5	\$96.07
821-T200PRBR	PVC Hub - 4-1/2" Rnd Strainer w/ DoubleDuty™ Test Plug	Bl	1	5	\$96.07
<b>SQUARE RING &amp; STRAINER</b>					
821-200ARBQ	ABS Hub - 4-1/2" Sqr Strainer	Bl	1	5	\$110.29
821-200PRBQ	PVC Hub - 4-1/2" Sqr Strainer	Bl	1	5	\$110.29
821-T200ARBQ	ABS Hub - 4-1/2" Sqr Strainer w/ DoubleDuty™ Test Plug	Bl	1	5	\$110.29
821-T200PRBQ	PVC Hub - 4-1/2" Sqr Strainer w/ DoubleDuty™ Test Plug	Bl	1	5	\$110.29
<b>COMPONENT ITEMS</b>					
821-2LRBQ	4-1/2" Sqr Strainer	Bl	1	5	\$102.16
821-2LRBR	4-1/2" Rnd Strainer	Bl	1	5	\$87.94
821-MHA2	2" ABS Hub - Base & Collar Only	Bl	25	25	\$8.13
821-MHP2	2" PVC Hub - Base & Collar Only	Bl	25	25	\$8.13
<b>821-TMHA2</b>	2" ABS Hub - Base & Collar Only w/ DoubleDuty™ Test Plug	Bl	25	25	\$8.13
<b>821-TMHP2</b>	2" PVC Hub - Base & Collar Only w/ DoubleDuty™ Test Plug	Bl	25	25	\$8.13
<b>ACCESSORIES</b>					
821-EX2	Threaded Extension Adapter - 2-3/8" Min - 4-3/4" Max	Bl	1	10	\$4.94
821-H	Hair Catcher	B	10	100	\$0.75
821-TP	Test Plug For 821 Shower Drain	Bl	10	10	\$3.55
835-2	Trapshield™ For 2" Drain Outlet	Bl	1	50	\$56.31



821-200PRBR



821-T200ARBQ

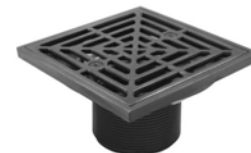

821-2LRBQ



821-EX2

**Grid-Pattern Head & Strainer**

**2" PVC/ABS - Sch.40 Hub Connection**

Item Number	Item Description	Pkg Type	Min Qty	Case Qty	Price
<b>CHROME-PLATED FINISH</b>					
821-2ACP	ABS Hub - 4-1/8" Rnd Strainer	BI	1	5	\$49.81
821-2AQCP	ABS Hub - 4-1/8" Sqr Strainer	BI	1	5	\$56.92
821-2PCP	PVC Hub - 4-1/8" Rnd Strainer	BI	1	5	\$49.81
821-2PQCP	PVC Hub - 4-1/8" Sqr Strainer	BI	1	5	\$56.92
821-T2ACP	ABS Hub - 4-1/8" Rnd Strainer w/ DoubleDuty™ Test Plug	BI	1	5	\$49.81
821-T2AQCP	ABS Hub - 4-1/8" Sqr Strainer w/ DoubleDuty™ Test Plug	BI	1	5	\$56.92
821-T2PCP	PVC Hub - 4-1/8" Rnd Strainer w/ DoubleDuty™ Test Plug	BI	1	5	\$49.81
821-T2PQCP	PVC Hub - 4-1/8" Sqr Strainer w/ DoubleDuty™ Test Plug	BI	1	5	\$56.92
<b>OIL-RUBBED BRONZE FINISH</b>					
821-2AQRB	ABS Hub - 4-1/8" Sqr Strainer	BI	1	5	\$85.38
821-2PQRB	PVC Hub - 4-1/8" Sqr Strainer	BI	1	5	\$85.38
<b>821-T2AQRB</b>	ABS Hub - 4-1/8" Sqr Strainer w/ DoubleDuty™ Test Plug	BI	1	5	\$85.38
821-T2PQRB	PVC Hub - 4-1/8" Sqr Strainer w/ DoubleDuty™ Test Plug	BI	1	5	\$85.38
<b>COMPONENT ITEMS</b>					
821-2LQRB	4-1/8" Sqr Strainer	BI	1	5	\$77.25
821-HCP	4-1/8" Rnd Strainer	BI	1	5	\$41.66
821-HQCP	4-1/8" Sqr Strainer	BI	1	5	\$48.80
821-MHA2	2" ABS Hub - Base & Collar Only	BI	25	25	\$8.13
821-MHP2	2" PVC Hub - Base & Collar Only	BI	25	25	\$8.13
<b>821-TMHA2</b>	2" ABS Hub - Base & Collar Only w/ DoubleDuty™ Test Plug	BI	25	25	\$8.13
<b>821-TMHP2</b>	2" PVC Hub - Base & Collar Only w/ DoubleDuty™ Test Plug	BI	25	25	\$8.13
<b>ACCESSORIES</b>					
821-EX2	Threaded Extension Adapter - 2-3/8" Min - 4-3/4" Max	BI	1	10	\$4.94
821-TP	Test Plug For 821 Shower Drain	BI	10	10	\$3.55
835-2	Trapshield™ For 2" Drain Outlet	BI	1	50	\$56.31



821-2ACP



821-2PQRB



821-HCP



821-EX2

Supply

Drainage

Support

Specialties

Appendix

**Tile-Insert Strainer**

**2" PVC/ABS - Sch.40 Hub Connection**

Item Number	Item Description	Pkg Type	Min Qty	Case Qty	Price
<b>ABS HEAD</b>					
821-2AT4A	ABS Hub - 4" Head, Stainless Tile-In Tray	BI	1	5	\$64.49
821-2AT5A	ABS Hub - 5" Head, Stainless Tile-In Tray	BI	1	5	\$74.17
821-2PT4A	PVC Hub - 4" Head, Stainless Tile-In Tray	BI	1	5	\$64.49
821-2PT5A	PVC Hub - 5" Head, Stainless Tile-In Tray	BI	1	5	\$74.17
821-T2AT4A	ABS Hub - 4" Head, Stainless Tile-In Tray w/ DoubleDuty™ Test Plug	BI	1	5	\$64.49
821-T2AT5A	ABS Hub - 5" Head, Stainless Tile-In Tray w/ DoubleDuty™ Test Plug	BI	1	5	\$74.17
821-T2PT4A	PVC Hub - 4" Head, Stainless Tile-In Tray w/ DoubleDuty™ Test Plug	BI	1	5	\$64.49
821-T2PT5A	PVC Hub - 5" Head, Stainless Tile-In Tray w/ DoubleDuty™ Test Plug	BI	1	5	\$74.17
<b>STAINLESS STEEL HEAD</b>					
821-2ATQ	ABS Hub - 5" Head, Stainless Tile-In Tray	BI	1	1	\$107.45
821-2PTQ	PVC Hub - 5" Head, Stainless Tile-In Tray	BI	1	1	\$107.45
821-T2ATQ	ABS Hub - 5" Head, Stainless Tile-In Tray w/ DoubleDuty™ Test Plug	BI	1	1	\$107.45
821-T2PTQ	PVC Hub - 5" Head, Stainless Tile-In Tray w/ DoubleDuty™ Test Plug	BI	1	1	\$107.45
<b>COMPONENT ITEMS</b>					
821-2LT4A	4" ABS Head, Stainless Tile-In Tray	BI	1	4	\$56.35
821-2LT5A	5" ABS Head, Stainless Tile-In Tray	BI	1	10	\$65.62
821-2LTQ	5" Stainless Steel Head, Stainless Tile-In Tray	BI	1	20	\$99.31
821-MHA2	2" ABS Hub - Base & Collar Only	BI	25	25	\$8.13
821-MHP2	2" PVC Hub - Base & Collar Only	BI	25	25	\$8.13
<b>821-TMHA2</b>	2" ABS Hub - Base & Collar Only w/ DoubleDuty™ Test Plug	BI	25	25	\$8.13
<b>821-TMHP2</b>	2" PVC Hub - Base & Collar Only w/ DoubleDuty™ Test Plug	BI	25	25	\$8.13
<b>ACCESSORIES</b>					
821-EX2	Threaded Extension Adapter - 2-3/8" Min - 4-3/4" Max	BI	1	10	\$4.94
821-H	Hair Catcher	B	10	100	\$0.75
821-TP	Test Plug For 821 Shower Drain	BI	10	10	\$3.55
835-2	Trapshield™ For 2" Drain Outlet	BI	1	50	\$56.31



821-2AT5A



821-2PTQ



821-2LTQ



821-EX2

Supply

Drainage

Support

Specialties

Appendix

Supply

Drainage

Support

Specialties

Appendix



820-27P



820-27PQ



820-20PNQ

## Adjustable Slab Shower Drain 2" PVC Sch. 40 Hub Connection

Item Number	Item Description	Pkg Type	Min Qty	Case Qty	Price
<b>SCREW-ON STAINLESS STEEL STRAINER</b>					
820-2P	4-1/4" Stnls Steel Rnd Strainer	BI	20	20	\$9.14
820-T2P	4-1/4" Stnls Steel Rnd Strainer w/ DoubleDuty™ Test Plug	BI	10	10	\$9.14
<b>SNAP-IN STAINLESS STEEL STRAINER</b>					
820-27P	4-1/4" Stnls Steel Sqr Strainer	BI	20	20	\$9.14
820-27PQ	4-1/4" Stnls Steel Sqr Strainer	BI	20	20	\$16.75
820-T27P	4-1/4" Stnls Steel Sqr Strainer w/ DoubleDuty™ Test Plug	BI	10	10	\$9.14
820-T27PQ	4-1/4" Stnls Steel Sqr Strainer w/ DoubleDuty™ Test Plug	BI	10	10	\$16.75
<b>DELUXE ROUND RING &amp; STRAINER</b>					
820-20PCR	4-1/2" Chrome Rnd Strainer	BI	6	6	\$60.52
820-20PKR	4-1/2" Nikl Rnd Strainer	BI	6	6	\$59.63
820-20PRBR	4-1/2" Oil-Rubbed Brnz Rnd Strainer	BI	6	6	\$87.62
820-T20PCR	4-1/2" Chrome Rnd Strainer w/ DoubleDuty™ Test Plug	BI	6	6	\$60.52
820-T20PKR	4-1/2" Rnd Strainer w/ DoubleDuty™ Test Plug	BI	6	6	\$59.63
820-T20PRBR	4-1/2" Oil-Rubbed Brnz Rnd Strainer w/ DoubleDuty™ Test Plug	BI	6	6	\$87.62
<b>DELUXE SQUARE RING &amp; STRAINER</b>					
820-20PCQ	4-1/2" Chrome Sqr Strainer	BI	6	6	\$74.06
820-20PKQ	4-1/2" Nikl Sqr Strainer	BI	6	6	\$72.97
820-20PRBQ	4-1/2" Oil-Rubbed Brnz Sqr Strainer	BI	6	6	\$101.18
820-T20PCQ	4-1/2" Chrome Sqr Strainer w/ DoubleDuty™ Test Plug	BI	6	6	\$74.06
820-T20PKQ	4-1/2" Sqr Strainer w/ DoubleDuty™ Test Plug	BI	6	6	\$72.97
820-T20PRBQ	4-1/2" Oil-Rubbed Brnz Sqr Strainer w/ DoubleDuty™ Test Plug	BI	6	6	\$101.18
<b>ACCESSORIES</b>					
821-H	Hair Catcher	B	10	100	\$0.75
821-TP	Test Plug For 821 Shower Drain	BI	10	10	\$3.55
835-2	Trapshield™ For 2" Drain Outlet	BI	1	50	\$56.31

## Large-Capacity Shower Pan Drains 3" PVC/ABS Sch. 40 Hub Connection



863-435NQ

### Related Products

Halo™ Drain with Clamping Collar Option p 337

Item Number	Item Description	Pkg Type	Min Qty	Case Qty	Price
<b>NICKEL-BRONZE RING &amp; STRAINER</b>					
863-335NQ	3" ABS Hub - 5-7/8" Sqr Ring & Strainer	BI	1	2	\$111.38
863-335NR	3" ABS Hub - 5-1/2" Rnd Ring & Strainer	BI	1	6	\$90.38
863-435NQ	3" PVC Hub - 5-7/8" Sqr Ring & Strainer	BI	1	2	\$111.38
863-435NR	3" PVC Hub - 5-1/2" Rnd Ring & Strainer	BI	1	6	\$90.38

## Large-Capacity Shower Pan Drains (Cont)

### 3" PVC/ABS Sch. 40 Hub Connection

Item Number	Item Description	Pkg Type	Min Qty	Case Qty	Price
<b>POLISHED STAINLESS STEEL RING &amp; STRAINER</b>					
863-335CQ	3" ABS Hub - 5-7/8" Sqr Ring & Strainer	Bl	1	2	\$126.38
863-335CR	3" ABS Hub - 5-1/2" Rnd Ring & Strainer	Bl	1	1	\$104.38
863-435CQ	3" PVC Hub - 5-7/8" Sqr Ring & Strainer	Bl	1	2	\$126.38
863-435CR	3" PVC Hub - 5-1/2" Rnd Ring & Strainer	Bl	1	6	\$104.38
<b>MATTE STAINLESS STEEL RING &amp; STRAINER</b>					
863-335SQ	3" ABS Hub - 5-7/8" Sqr Ring & Strainer	Bl	1	2	\$111.38
863-335SR	3" ABS Hub - 5-1/2" Rnd Ring & Strainer	Bl	1	6	\$90.38
863-435SQ	3" PVC Hub - 5-7/8" Sqr Ring & Strainer	Bl	1	2	\$111.38
863-435SR	3" PVC Hub - 5-1/2" Rnd Ring & Strainer	Bl	1	6	\$90.38
<b>OIL-RUBBED BRONZE RING &amp; STRAINER</b>					
863-335RBQ	3" ABS Hub - 5-7/8" Sqr Ring & Strainer	Bl	1	2	\$126.38
863-335RBR	3" ABS Hub - 5-1/2" Rnd Ring & Strainer	Bl	1	6	\$104.38
863-435RBQ	3" PVC Hub - 5-7/8" Sqr Ring & Strainer	Bl	1	2	\$126.38
863-435RBR	3" PVC Hub - 5-1/2" Rnd Ring & Strainer	Bl	1	6	\$104.38
<b>ACCESSORIES</b>					
822-EX3	Ductile Iron Extension Adapter	B	1	1	\$35.33
835-3	Trapshield™ For 3" Drain Outlet	Bl	1	25	\$63.36
835-35	Trapshield™ For 3-1/2" Drain Head	Bl	1	25	\$63.36

## Halo™ Shower Pan Drain

### 2" PVC/ABS - Sch. 40 Hub Connection

Item Number	Item Description	Pkg Type	Min Qty	Case Qty	Price
<b>DRAINS</b>					
822-S2A	ABS Hub - Debris Cover	Bl	6	6	\$33.40
822-S2P	PVC Hub - Debris Cover	Bl	6	6	\$33.40



863-435CQ



863-435SR



863-435RBQ



822-S2P

Supply

Drainage

Support

Specialties

Appendix

Supply

Drainage

Support

Specialties

Appendix



821-2IHCP



821-2ITQCP



821-HCP



821-2INS



821-2IFS



821-HSQ

### Cast Iron Shower Drains

#### 3-Piece Drain with Grid-Pattern Head & Strainer

Item Number	Item Description	Pkg Type	Min Qty	Case Qty	Price
<b>2" NO-HUB CONNECTION</b>					
821-2IHCP	4-1/8" Rnd Strainer	BI	1	5	\$94.30
821-2IHQCP	4-1/8" Sqr Strainer	BI	1	5	\$102.10
<b>2" FIP THREAD CONNECTION</b>					
821-2ITCP	4-1/8" Rnd Strainer	BI	1	5	\$98.19
821-2ITQCP	4-1/8" Sqr Strainer	BI	1	5	\$105.99
<b>COMPONENT ITEMS</b>					
821-2IH	2" No-Hub	BI	1	10	\$52.21
821-2IT	2" FIP	BI	1	10	\$51.23
821-HCP	4-1/8" Rnd Strainer	BI	1	5	\$41.66
821-HQCP	4-1/8" Sqr Strainer	BI	1	5	\$48.80
<b>ACCESSORIES</b>					
821-EX2	Threaded Extension Adapter - 2-3/8" Min - 4-3/4" Max	BI	1	10	\$4.94
835-2	Trapshield™ For 2" Drain Outlet	BI	1	50	\$56.31

### Cast Iron Shower Drains

#### 2-Piece Drain with Stamped Stainless Steel Strainer

Item Number	Item Description	Pkg Type	Min Qty	Case Qty	Price
<b>2" NO-CAULK CONNECTION</b>					
821-2INS	3-1/2" Rnd Strainer	CI	1	4	\$47.55
<b>2" FIP THREAD CONNECTION</b>					
821-2IFS	3-1/2" Rnd Strainer	CI	4	4	\$39.74
<b>ACCESSORIES</b>					
821-HSQ	4" Sqr Stnls Steel Strainer Ring Only	CI	1	10	\$9.30
821-HSR	3-1/2" Rnd Stnls Steel Strainer	CI	1	10	\$10.02



## Stainless Steel Linear Shower Drain

## 2" PVC/ABS Sch. 40 Hub Connection

Item Number	Item Description	Pkg Type	Min Qty	Case Qty	Price
<b>STAMPED STAINLESS STEEL STRAINER</b>					
823-TX26SA	ABS Hub - 26" Linear Drain	Bl	1	1	\$289.31
823-TX26SP	PVC Hub - 26" Linear Drain	Bl	1	1	\$289.31
823-TX30SA	ABS Hub - 30" Linear Drain	Bl	1	1	\$311.90
823-TX30SP	PVC Hub - 30" Linear Drain	Bl	1	1	\$311.90
823-TX36SA	ABS Hub - 36" Linear Drain	Bl	1	1	\$334.49
823-TX36SP	PVC Hub - 36" Linear Drain	Bl	1	1	\$334.49
823-TX40SA	ABS Hub - 40" Linear Drain	Bl	1	1	\$345.80
823-TX40SP	PVC Hub - 40" Linear Drain	Bl	1	1	\$345.80
823-TX48SA	ABS Hub - 48" Linear Drain	Bl	1	1	\$366.15
823-TX48SP	PVC Hub - 48" Linear Drain	Bl	1	1	\$366.15
823-TX60SA	ABS Hub - 60" Linear Drain	Bl	1	1	\$404.56
823-TX60SP	PVC Hub - 60" Linear Drain	Bl	1	1	\$404.56
<b>STAINLESS STEEL WEDGEWIRE STRAINER</b>					
823-TX26WA	ABS Hub - 26" Linear Drain	Bl	1	1	\$743.61
823-TX26WP	PVC Hub - 26" Linear Drain	Bl	1	1	\$743.61
823-TX30WA	ABS Hub - 30" Linear Drain	Bl	1	1	\$766.19
823-TX30WP	PVC Hub - 30" Linear Drain	Bl	1	1	\$766.19
823-TX36WA	ABS Hub - 36" Linear Drain	Bl	1	1	\$845.30
823-TX36WP	PVC Hub - 36" Linear Drain	Bl	1	1	\$845.30
823-TX40WA	ABS Hub - 40" Linear Drain	Bl	1	1	\$879.19
823-TX40WP	PVC Hub - 40" Linear Drain	Bl	1	1	\$879.19
823-TX48WA	ABS Hub - 48" Linear Drain	Bl	1	1	\$947.01
823-TX48WP	PVC Hub - 48" Linear Drain	Bl	1	1	\$947.01
823-TX60WA	ABS Hub - 60" Linear Drain	Bl	1	1	\$1,037.40
823-TX60WP	PVC Hub - 60" Linear Drain	Bl	1	1	\$1,037.40
<b>TILE-INSERT STRAINER</b>					
823-TX26TA	ABS Hub - 26" Linear Drain	Bl	1	1	\$289.31
823-TX26TP	PVC Hub - 26" Linear Drain	Bl	1	1	\$289.31
823-TX30TA	ABS Hub - 30" Linear Drain	Bl	1	1	\$311.90
823-TX30TP	PVC Hub - 30" Linear Drain	Bl	1	1	\$311.90
823-TX36TA	ABS Hub - 36" Linear Drain	Bl	1	1	\$334.49
823-TX36TP	PVC Hub - 36" Linear Drain	Bl	1	1	\$334.49
823-TX40TA	ABS Hub - 40" Linear Drain	Bl	1	1	\$345.80
823-TX40TP	PVC Hub - 40" Linear Drain	Bl	1	1	\$345.80
823-TX48TA	ABS Hub - 48" Linear Drain	Bl	1	1	\$366.15
823-TX48TP	PVC Hub - 48" Linear Drain	Bl	1	1	\$366.15
823-TX60TA	ABS Hub - 60" Linear Drain	Bl	1	1	\$404.56
823-TX60TP	PVC Hub - 60" Linear Drain	Bl	1	1	\$404.56
<b>ACCESSORIES</b>					
821-EX2	Threaded Extension Adapter - 2-3/8" Min - 4-3/4" Max	Bl	1	10	\$4.94
821-TP	Test Plug For 821 Shower Drain	Bl	10	10	\$3.55
835-2	Trapshield™ For 2" Drain Outlet	Bl	1	50	\$56.31



823-TX26SP



823-TX26WP



823-TX26TP

Supply

Drainage

Support

Specialties

Appendix



823-T2A36V

### Site-Adjustable Linear Shower Drain

#### 2" PVC/ABS Sch. 40 Hub Connection

Item Number	Item Description	Pkg Type	Min Qty	Case Qty	Price
<b>STAMPED STAINLESS STEEL STRAINER</b>					
823-T2A36V	ABS Hub - 36" Linear Drain Kit	BI	1	1	\$276.51
823-T2A72V	ABS Hub - 72" Linear Drain Kit	BI	1	1	\$407.68
823-T2P36V	PVC Hub - 36" Linear Drain Kit	BI	1	1	\$276.51
823-T2P72V	PVC Hub - 72" Linear Drain Kit	BI	1	1	\$407.68
<b>TILE-INSERT STRAINER</b>					
823-T2A36T	ABS Hub - 36" Linear Drain Kit	BI	1	1	\$317.88
823-T2A72T	ABS Hub - 72" Linear Drain Kit	BI	1	1	\$478.59
823-T2P36T	PVC Hub - 36" Linear Drain Kit	BI	1	1	\$317.88
823-T2P72T	PVC Hub - 72" Linear Drain Kit	BI	1	1	\$478.59
<b>ACCESSORIES</b>					
821-EX2	Threaded Extension Adapter - 2-3/8" Min - 4-3/4" Max	BI	1	10	\$4.94
821-TP	Test Plug For 821 Shower Drain	BI	10	10	\$3.55
835-2	Trapshield™ For 2" Drain Outlet	BI	1	50	\$56.31

### Low-Profile Linear Shower Drain

#### 2" PVC Sch. 40 Hub Connection



823-24PSS

Item Number	Item Description	Pkg Type	Min Qty	Case Qty	Price
<b>STAMPED STAINLESS STEEL STRAINER</b>					
823-24PSS	24" Channel Length	BI	1	1	\$951.57
823-32PSS	32" Channel Length	BI	1	1	\$1,154.74
823-40PSS	40" Channel Length	BI	1	1	\$1,357.59
823-60PSS	60" Channel Length	BI	1	1	\$1,806.32
<b>TILE-INSERT STRAINER</b>					
823-24PST	24" Channel Length	BI	1	1	\$951.57
823-32PST	32" Channel Length	BI	1	1	\$1,177.84
823-40PST	40" Channel Length	BI	1	1	\$1,384.73
823-60PST	60" Channel Length	BI	1	1	\$1,842.46
<b>ACCESSORIES</b>					
823-FK24	Full-Mortar-Bed Adapter Kit For 24" Streamline™	BI	1	1	\$138.29
823-FK32	Full-Mortar-Bed Adapter Kit For 32" Streamline™	BI	1	1	\$138.29
823-FK40	Full-Mortar-Bed Adapter Kit For 40" Streamline™	BI	1	1	\$138.29
823-FK60	Full-Mortar-Bed Adapter Kit For 60" Streamline™	BI	1	1	\$177.86
823-FKT24	Full-Mortar-Bed Adapter Kit For 24" Tile-In Streamline™	BI	1	1	\$221.20
823-FKT32	Full-Mortar-Bed Adapter Kit For 32" Tile-In Streamline™	BI	1	1	\$221.20
823-FKT40	Full-Mortar-Bed Adapter Kit For 40" Tile-In Streamline™	BI	1	1	\$221.20
823-FKT60	Full-Mortar-Bed Adapter Kit For 60" Tile-In Streamline™	BI	1	1	\$261.78

**825 Series - Receptor-Base Style**

**2" PVC/ABS Sch. 40 Hub Connection**

Item Number	Item Description	Pkg Type	Min Qty	Case Qty	Price
<b>SCREW-ON STAINLESS STEEL STRAINER</b>					
825-1P	1-1/2" PVC Hub - 4-1/4" Rnd Strainer	Bl	20	20	\$11.07
825-20A	2" ABS Hub - 4-1/4" Rnd Strainer	Bl	20	20	\$11.07
825-20P	2" PVC Hub - 4-1/4" Rnd Strainer	Bl	20	20	\$11.07
825-2A	2" ABS Hub - 4-1/4" Rnd Strainer	Bl	20	20	\$9.32
825-2APK	2" ABS Hub - 4-1/4" Rnd Strainer	Bl	12	12	\$10.32
825-2P	2" PVC Hub - 4-1/4" Rnd Strainer	Bl	20	20	\$9.32
825-2PPK	2" PVC Hub - 4-1/4" Rnd Strainer	Cl	12	12	\$10.32
<b>SNAP-IN STAINLESS STEEL STRAINER</b>					
825-17P	1-1/2" PVC Hub - 4-1/4" Rnd Strainer	Bl	20	20	\$10.93
825-27A	2" ABS Hub - 4-1/4" Rnd Strainer	Bl	20	20	\$9.19
825-27P	2" PVC Hub - 4-1/4" Rnd Strainer	Bl	20	20	\$9.19
<b>ACCESSORIES</b>					
821-H	Hair Catcher	B	10	100	\$0.75
835-2	Trapshield™ For 2" Drain Outlet	Bl	1	50	\$56.31



825-20P



825-27A

**825 Series - Offset Receptor-Base Style**

**2" PVC/ABS Sch. 40 Hub Connection**

Item Number	Item Description	Pkg Type	Min Qty	Case Qty	Price
<b>SCREW-ON STAINLESS STEEL STRAINER</b>					
825-2AFS	2" ABS Hub - 4-1/4" Rnd Strainer	Cl	10	10	\$14.86
825-2PFS	2" PVC Hub - 4-1/4" Rnd Strainer	Cl	10	10	\$14.86



825-2PFS

**No-Caulk Connection**

**2" No-Caulk Connection**

Item Number	Item Description	Pkg Type	Min Qty	Case Qty	Price
<b>BRASS BODY - STAINLESS STEEL STRAINER</b>					
827-2B	2" No-Caulk Conn. - 4-1/4" Rnd Strainer	Cl	10	20	\$31.73
<b>POLYPRO BODY - STAINLESS STEEL STRAINER</b>					
828-2	2" No-Caulk Conn. - 4-1/4" Rnd Strainer	Bl	1	20	\$11.97
828-2PK	2" No-Caulk Conn. - 4-1/4" Rnd Strainer	Cl	10	10	\$12.97
<b>ACCESSORIES</b>					
821-H	Hair Catcher	B	10	100	\$0.75
827-2BG	Elastomer Comp. Gasket	B	1	100	\$2.27
828-GC	Elastomer Compression Gasket For Copper Pipe	B	1	1	\$2.53
835-2	Trapshield™ For 2" Drain Outlet	Bl	1	50	\$56.31



827-2B



828-2

Supply

Drainage

Support

Specialties

Appendix



827-2J

### JackRabbit™ Outer-Locknut Style

#### 2" No-Caulk Connection

Item Number	Item Description	Pkg Type	Min Qty	Case Qty	Price
<b>BRASS BODY - STAINLESS STEEL STRAINER</b>					
827-2J	2" Brass No-Caulk Conn. - 4-1/4" Rnd Strainer	CI	1	6	\$54.63
<b>ACCESSORIES</b>					
821-H	Hair Catcher	B	10	100	\$0.75
827-2BG	Elastomer Comp. Gasket	B	1	100	\$2.27
828-GC	Elastomer Compression Gasket For Copper Pipe	B	1	1	\$2.53
835-2	Trapshield™ For 2" Drain Outlet	BI	1	50	\$56.31



826-2P

### 826 Series - Outer-Locknut Style

#### 2" Glue-or-Gasket Connection

Item Number	Item Description	Pkg Type	Min Qty	Case Qty	Price
<b>2" GLUE-OR-GASKET CONNECTION</b>					
826-2A	2" ABS Hub - 4-1/4" Rnd Strainer	BI	1	20	\$21.90
826-2P	2" PVC Hub - 4-1/4" Rnd Strainer	BI	1	20	\$21.90
826-2PPK	2" PVC Hub - 4-1/4" Rnd Strainer	CI	10	10	\$22.90
<b>ACCESSORIES</b>					
821-H	Hair Catcher	B	10	100	\$0.75
835-2	Trapshield™ For 2" Drain Outlet	BI	1	50	\$56.31

### Freestanding Tub Drain

#### 2" PVC/ABS - Sch.40 Hub Connection

Item Number	Item Description	Pkg Type	Min Qty	Case Qty	Price
819-2P	PVC Hub - Tub Drain	BI	6	6	\$27.00



819-2P

Supply

Drainage

Support

Specialties

Appendix



827-2S

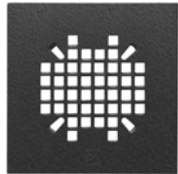

827-2RBQ

### Snap-In Strainers

#### Stamped (19 ga)

Item Number	Item Description	Pkg Type	Min Qty	Case Qty	Price
<b>STAINLESS STEEL</b>					
827-2S	4-1/4" Rnd Snap-In	BI	1	100	\$3.47
827-2SPK1	4-1/4" Rnd Snap-In, Cut Case	CI	10	10	\$4.97
827-2SQPK1	4-1/4" Sqr Snap-In, Cut Case	CI	1	5	\$8.88
<b>OIL-RUBBED BRONZE FINISH</b>					
827-2RB	4-1/4" Rnd Snap-In	BI	1	100	\$16.55
827-2RBPK1	4-1/4" Rnd Snap-In, Cut Case	CI	6	6	\$18.05
827-2RBQ	4-1/4" Sqr Snap-In	BI	1	100	\$22.79
827-2RBQPK1	4-1/4" Sqr Snap-In, Cut Case	CI	1	5	\$23.04
<b>SATIN NICKEL FINISH</b>					
827-2SNPK2	4-1/4" Rnd Snap-In	BI	1	5	\$17.31
827-2SNQPK1	4-1/4" Sqr Snap-In, Cut Case	CI	1	5	\$20.86
<b>MATTE BLACK FINISH</b>					
827-2SMQPK1	4-1/4" Sqr Snap-In	CI	1	5	\$22.79
827-2SMRPK1	4-1/4" Rnd Snap-In	CI	1	5	\$18.21
<b>WHITE ENAMEL FINISH</b>					
827-2SWPK1	4-1/4" Rnd Snap-In, Cut Case	CI	5	5	\$13.37
<b>POLISHED BRASS FINISH</b>					
827-2SPPK1	4-1/4" Rnd Snap-In, Cut Case	CI	5	5	\$13.24

### Screw-On Strainers

#### Stamped (19 ga)



821-2S

Item Number	Item Description	Pkg Type	Min Qty	Case Qty	Price
<b>STAINLESS STEEL</b>					
821-2S	4-1/4" Diameter	BI	1	100	\$4.24
821-2SPK1	4-1/4" Diameter	CI	10	10	\$5.74

### Cast Ring & Strainers

#### Round Pattern



821-2SKRPK1



821-2SRBRPK1

Item Number	Item Description	Pkg Type	Min Qty	Case Qty	Price
<b>CHROME FINISH</b>					
821-2SCRPK2	4-1/2" Diameter	BI	1	50	\$55.22
<b>POLISHED STAINLESS STEEL</b>					
821-2SCRPK1	4-1/2" Diameter	BI	1	10	\$55.22
<b>SATIN NICKEL FINISH</b>					
821-2SKRPK1	4-1/2" Diameter	BI	6	6	\$55.62
821-2SKRPK2	4-1/2" Diameter	BI	1	50	\$55.22
<b>OIL-RUBBED BRONZE FINISH</b>					
821-2SRBRPK1	4-1/2" Diameter	CI	6	6	\$83.86
821-2SRBRPK2	4-1/2" Diameter	BI	1	50	\$83.86
<b>MATTE BLACK FINISH</b>					
821-2SMRPK2	4-1/2" Diameter	CI	1	5	\$83.86

**Cast Ring & Strainers (Cont)**

**Round Pattern**

Item Number	Item Description	Pkg Type	Min Qty	Case Qty	Price
<b>MATTE STAINLESS STEEL</b>					
821-2SSRPK1	4-1/2" Diameter	BI	1	10	\$40.88
<b>NICKEL-BRONZE</b>					
821-2SNRPK1	4-1/2" Diameter	CI	6	6	\$40.88

**Cast Ring & Strainers**

**Square Pattern**

Item Number	Item Description	Pkg Type	Min Qty	Case Qty	Price
<b>CHROME FINISH</b>					
821-2SCQPK2	4-1/2" Diameter	BI	1	50	\$69.53
<b>POLISHED STAINLESS STEEL</b>					
821-2SCQPK1	4-1/2" Diameter	BI	1	10	\$69.53
<b>SATIN NICKEL FINISH</b>					
821-2SKQPK1	4-1/2" Diameter	BI	1	10	\$69.53
821-2SKQPK2	4-1/2" Diameter	BI	1	50	\$69.53
<b>OIL-RUBBED BRONZE FINISH</b>					
821-2SRBQPK1	4-1/2" Diameter	BI	1	10	\$98.21
821-2SRBQPK2	4-1/2" Diameter	BI	1	50	\$98.21
<b>MATTE BLACK FINISH</b>					
821-2SMQPK2	4-1/2" Diameter	CI	1	5	\$98.21
<b>MATTE STAINLESS STEEL</b>					
821-2SSQPK1	4-1/2" Diameter	CI	1	10	\$54.79
<b>NICKEL-BRONZE</b>					
821-2SNQPK1	4-1/2" Diameter	CI	1	10	\$55.22

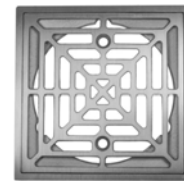

821-2SKQPK1



821-2SRBQPK1





# Residential Floor Drains

**WeldOne™ Integral Trap Drains**

**QuadDrain™ General-Purpose Drains**

**Pipe Strainers**

**Accessories**

Floor drains for residential basements and mechanical rooms, as well as a variety of models for garages and other applications available with PVC and ABS connections.

Drains available with durable yet economical poly strainers, or cast ring/strainers for finished areas.





**800-P**  
**Page 427**



**841-2P**  
**Page 428**



**840-27P**  
**Page 429**



**866-34PPK**  
**Page 429**



**845-3PPK**  
**Page 430**











**847-7**  
**Page 430**



**869-V4**  
**Page 431**



**801-A2**  
**Page 432**

 <b>800-P</b> <b>Page 427</b>	 <b>841-2P</b> <b>Page 428</b>	 <b>840-27P</b> <b>Page 429</b>	 <b>866-34PPK</b> <b>Page 429</b>	 <b>845-3PPK</b> <b>Page 430</b>
 <b>847-7</b> <b>Page 430</b>	 <b>869-V4</b> <b>Page 431</b>	 <b>801-A2</b> <b>Page 432</b>		

**WeldOne™**

**2" PVC/ABS Sch. 40 Hub Connection**

Item Number	Item Description	Pkg Type	Min Qty	Case Qty	Price
<b>POLYPRO STRAINER</b>					
800-A	ABS Hub - 6-1/2" Rnd Strainer	BI	12	12	\$29.69
800-ABW	ABS Hub - 6-1/2" Rnd Strainer w/ Backwater Device	BI	12	12	\$39.60
800-APK	ABS Hub - 6-1/2" Rnd Strainer	CI	3	3	\$31.19
800-P	PVC Hub - 6-1/2" Rnd Strainer	BI	12	12	\$29.69
800-PBW	PVC Hub - 6-1/2" Rnd Strainer w/ Backwater Device	BI	12	12	\$39.60
800-PPK	PVC Hub - 6-1/2" Rnd Strainer	BI	3	3	\$31.19
<b>NICKEL-BRONZE RING &amp; STRAINER</b>					
<b>800-ANQ</b>	ABS Hub - 7" Sqr Ring & Strainer	BI	1	2	\$121.86
<b>800-ANR</b>	ABS Hub - 6-1/2" Rnd Ring & Strainer	BI	1	2	\$86.01
<b>800-PNQ</b>	PVC Hub - 7" Sqr Ring & Strainer	BI	1	2	\$121.86
800-PNR	PVC Hub - 6-1/2" Rnd Ring & Strainer	BI	1	2	\$86.01
<b>STAINLESS STEEL RING &amp; STRAINER</b>					
<b>800-ASQ</b>	ABS Hub - 7" Sqr Ring & Strainer	BI	1	2	\$121.86
<b>800-ASR</b>	ABS Hub - 6-1/2" Rnd Ring & Strainer	BI	1	2	\$86.01
<b>800-PSQ</b>	PVC Hub - 7" Sqr Ring & Strainer	BI	1	1	\$121.86
<b>800-PSR</b>	PVC Hub - 6-1/2" Rnd Ring & Strainer	BI	1	1	\$86.01
<b>DUCTILE IRON RING &amp; STRAINER</b>					
<b>800-AIR</b>	ABS Hub - 6-1/2" Rnd Ring & Strainer	BI	1	2	\$59.94
<b>800-PIR</b>	PVC Hub - 6-1/2" Rnd Ring & Strainer	BI	1	2	\$59.94
<b>ACCESSORIES</b>					
802-7	Polypro Backwater Device For 2" FIP Threads	CI	12	12	\$8.41



800-P



800-ASR



802-7

Supply

Drainage

Support

Specialties

Appendix

Supply

Drainage

Support

Specialties

Appendix



841-2P



841-2PNQ



841-2PSR



841-29P



841-29PNR

**QuadDrain™**

**2x3 PVC/ABS Sch. 40 Hub**

Item Number	Item Description	Pkg Type	Min Qty	Case Qty	Price
<b>POLYPRO STRAINER</b>					
841-2A	2" ABS Hub - 6-1/2" Rnd Strainer	BI	12	12	\$15.92
841-2APK	2" ABS Hub - 6-1/2" Rnd Strainer	CI	6	6	\$16.92
841-2P	2" PVC Hub - 6-1/2" Rnd Strainer	BI	12	12	\$15.92
841-2PPK	2" PVC Hub - 6-1/2" Rnd Strainer	BI	6	6	\$16.92
<b>NICKEL-BRONZE RING &amp; STRAINER</b>					
841-2ANQ	2" ABS Hub - 7" Sqr Ring & Strainer	BI	1	1	\$112.20
841-2ANR	2" ABS Hub - 6-1/2" Rnd Ring & Strainer	BI	1	1	\$75.99
841-2PNQ	2" PVC Hub - 7" Sqr Ring & Strainer	BI	1	1	\$112.20
841-2PNR	2" PVC Hub - 6-1/2" Rnd Ring & Strainer	BI	1	6	\$75.99
<b>STAINLESS STEEL RING &amp; STRAINER</b>					
841-2ASQ	2" ABS Hub - 7" Sqr Ring & Strainer	BI	1	1	\$117.29
841-2ASR	2" ABS Hub - 6-1/2" Rnd Ring & Strainer	BI	1	1	\$79.46
841-2PSQ	2" PVC Hub - 7" Sqr Ring & Strainer	BI	1	1	\$117.29
841-2PSR	2" PVC Hub - 6-1/2" Rnd Ring & Strainer	BI	1	1	\$79.46
<b>DUCTILE IRON RING &amp; STRAINER</b>					
841-2AIR	2" ABS Hub - 6-1/2" Rnd Ring & Strainer	BI	1	1	\$49.20
841-2PIR	2" PVC Hub - 6-1/2" Rnd Ring & Strainer	BI	1	1	\$49.20
<b>ACCESSORIES</b>					
835-2	Trapshield™ For 2" Drain Outlet	BI	1	50	\$56.31

**QuadDrain™**

**Full-Slip Hub Connection**

Item Number	Item Description	Pkg Type	Min Qty	Case Qty	Price
<b>POLYPRO STRAINER</b>					
841-29P	2" PVC Hub - 6-1/2" Rnd Strainer	BI	12	12	\$15.92
841-39P	3" PVC Hub - 6-1/2" Rnd Strainer	BI	12	12	\$15.92
<b>NICKEL-BRONZE RING &amp; STRAINER</b>					
841-29PNR	2" PVC Hub - 6-1/2" Rnd Ring & Strainer	BI	1	2	\$75.99
<b>ACCESSORIES</b>					
835-2	Trapshield™ For 2" Drain Outlet	BI	1	50	\$56.31
835-3	Trapshield™ For 3" Drain Outlet	BI	1	25	\$63.36

**840 Series Floor Drains**

**PVC/ABS Sch. 40 Hub Connection**

Item Number	Item Description	Pkg Type	Min Qty	Case Qty	Price
<b>SCREW-ON STAINLESS STEEL STRAINER</b>					
840-2A	2" ABS Hub - 4-1/4" Rnd Strainer	Bl	1	20	\$8.25
840-2APK	2" ABS Hub - 4-1/4" Rnd Strainer	Cl	10	10	\$9.25
840-2P	2" PVC Hub - 4-1/4" Rnd Strainer	Bl	20	20	\$8.25
840-2PPK	2" PVC Hub - 4-1/4" Rnd Strainer	Cl	10	10	\$9.25
840-3A	3" ABS Hub - 4-1/4" Rnd Strainer	Bl	1	20	\$11.98
840-3APK	3" ABS Hub - 4-1/4" Rnd Strainer	Cl	10	10	\$12.98
840-3P	3" PVC Hub - 4-1/4" Rnd Strainer	Bl	20	20	\$11.98
840-3PPK	3" PVC Hub - 4-1/4" Rnd Strainer	Cl	10	10	\$12.98
<b>SNAP-IN STAINLESS STEEL STRAINER</b>					
840-27A	2" ABS Hub - 4-1/4" Rnd Strainer	Bl	20	20	\$8.25
840-27P	2" PVC Hub - 4-1/4" Rnd Strainer	Bl	20	20	\$8.25
<b>NICKEL-BRONZE RING &amp; STRAINER</b>					
840-20ANR	2" ABS Hub - 4-1/2" Rnd Ring & Strainer	Bl	1	10	\$47.07
<b>840-20PNQ</b>	2" PVC Hub - 4-1/2" Sqr Ring & Strainer	Bl	1	1	\$61.52
840-20PNR	2" PVC Hub - 4-1/2" Rnd Ring & Strainer	Bl	1	10	\$47.07
840-30ANR	3" ABS Hub - 4-1/2" Rnd Ring & Strainer	Bl	1	10	\$50.67
840-30PNR	3" PVC Hub - 4-1/2" Rnd Ring & Strainer	Bl	1	10	\$50.67
<b>STAINLESS STEEL RING &amp; STRAINER</b>					
<b>840-20PCQ</b>	2" PVC Hub - 4-1/2" Sqr Ring & Strainer	Bl	1	5	\$75.99
<b>840-20PSQ</b>	2" PVC Hub - 4-1/2" Sqr Ring & Strainer	Bl	1	1	\$61.52
<b>OIL-RUBBED BRONZE FINISH RING &amp; STRAINER</b>					
<b>840-20PRBQ</b>	2" PVC Hub - 4-1/2" Sqr Ring & Strainer	Bl	1	5	\$104.97
<b>ACCESSORIES</b>					
835-2	Trapshield™ For 2" Drain Outlet	Bl	1	50	\$56.31
835-3	Trapshield™ For 3" Drain Outlet	Bl	1	25	\$63.36



840-2A



840-27P



840-20ANR

**Bell-Trap Floor Drains**

**PVC/ABS Sch. 40 Hub Connection**

Item Number	Item Description	Pkg Type	Min Qty	Case Qty	Price
866-2PPK	1-1/2" Hub/Inside 2" PVC - 6" Diameter Top	Cl	5	5	\$12.93
866-34PPK	3" Hub/Inside 4" PVC - 9" Diameter Top	Cl	5	5	\$27.68



866-34PPK

**Bell-Trap Floor Drains**

**Cast Iron No-Hub Connection**

Item Number	Item Description	Pkg Type	Min Qty	Case Qty	Price
866-2I	2" No-Hub - 5-3/4" Diameter Top	Bl	1	4	\$46.71
866-3I	3" No-Hub - 9" Diameter Top	Bl	1	4	\$76.42



866-2I

Supply

Drainage

Support

Specialties

Appendix



845-2PPK

### Flush-to-Floor Pipe Drain

#### One-Piece ABS

Item Number	Item Description	Pkg Type	Min Qty	Case Qty	Price
845-2APK	Inside 2" ABS - 2-3/8" Rnd Strainer	CI	10	10	\$2.23
845-2PPK	Inside 2" PVC - 2-3/8" Rnd Strainer	CI	10	10	\$2.23
845-3APK	Inside 3" ABS - 3-1/2" Rnd Strainer	CI	10	10	\$2.81
845-3PPK	Inside 3" PVC - 3-1/2" Rnd Strainer	CI	10	10	\$2.81
845-4APK	Inside 4" ABS - 4-1/2" Rnd Strainer	CI	10	10	\$3.81
845-4PPK	Inside 4" PVC - 4-1/2" Rnd Strainer	CI	10	10	\$3.81



847-2

### Gripper™

#### Stainless Steel Pipe Strainers

Item Number	Item Description	Pkg Type	Min Qty	Case Qty	Price
847-2	Fits 2" Pipe	B	20	20	\$7.61
847-2PK1	Fits 2" Pipe, Clamshell	CI	5	5	\$9.11
847-3	Fits 3" Pipe	B	20	20	\$8.02
847-3PK1	Fits 3" Pipe, Clamshell	CI	10	10	\$9.52
847-4	Fits 4" Pipe	B	10	10	\$8.42
847-4PK1	Fits 4" Pipe, Clamshell	CI	10	10	\$9.92



847-7

### Replacelt™

#### Adjustable Stainless Steel Replacement Strainer

Item Number	Item Description	Pkg Type	Min Qty	Case Qty	Price
847-7	7-1/4" Diameter, Clamshell	CI	10	10	\$40.42
847-7B	7-1/4" Diameter	BI	20	20	\$33.23
847-9	9-1/4" Diameter	BI	1	10	\$80.04

## Cast Iron Floor Drains

## Residential Floor Drains

### Philadelphia Style Fresh Air Vent

#### Cast Iron Inside-Caulk Connection

Item Number	Item Description	Pkg Type	Min Qty	Case Qty	Price
869-V4	4"	BI	1	4	\$49.02



869-V4

### Pittsburgh Style Floor Drain

#### Cast Iron Inside-Caulk Connection

Item Number	Item Description	Pkg Type	Min Qty	Case Qty	Price
844-04IQ	4"	BI	1	4	\$45.59



844-04IQ

### St. Louis Style Floor Drain

#### Cast Iron Inside-Caulk Connection

Item Number	Item Description	Pkg Type	Min Qty	Case Qty	Price
844-02SL	2"	BI	1	1	\$16.27
844-04SL	3"	BI	1	1	\$49.20
844-0SL	4"	BI	1	1	\$34.05



844-02SL

Supply

Drainage

Support

Specialties

Appendix



801-A2

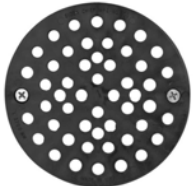

801-A



801-DR2

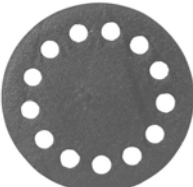

866-S2I

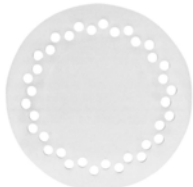

866-3S

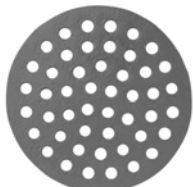

844-02G

### Strainers for Weld One / Quad Drain

Item Number	Item Description	Pkg Type	Min Qty	Case Qty	Price
<b>NEW PATTERN</b>					
801-A2	6-1/8" Diameter, Rnd, Black Polypro	BI	1	25	\$6.82
801-P2	6-1/8" Diameter, Rnd, White Polypro	BI	1	25	\$6.82
801-P2PK	6-1/8" Diameter, Rnd, White Polypro	BI	10	10	\$7.07
801-PG2	6-1/8" Diameter, Rnd, Gray Polypro	BI	1	25	\$6.82
<b>CLASSIC PATTERN</b>					
801-A	6-3/4" Diameter, Rnd, Black Poly	BI	1	25	\$6.82
801-APK	6-3/4" Diameter, Rnd, Black Polypro	CI	10	10	\$7.07
801-P	6-3/4" Diameter, Rnd, White Polypro	BI	1	25	\$6.82
801-PPK	6-3/4" Diameter, Rnd, White Polypro	CI	10	10	\$7.07
<b>CAST METAL RING &amp; STRAINER</b>					
801-DR2	6-1/2" Diameter, Rnd, Ductile Iron	BI	1	10	\$32.59
801-NQ2	7" Diameter, Sqr, Nikl-Brnz	BI	1	10	\$103.22
801-NR2	6-1/2" Diameter, Rnd, Nikl-Brnz	BI	1	10	\$63.99
<b>801-SQ2</b>	7" Diameter, Sqr, Stnls Steel	BI	1	10	\$103.22
801-SR2	6-1/2" Diameter, Rnd, Stnls Steel	BI	1	10	\$63.99

### Strainers for Bell Trap Drain

Item Number	Item Description	Pkg Type	Min Qty	Case Qty	Price
<b>STRAINERS FOR 6X6 DRAINS</b>					
866-2S	4-9/16" Diameter, Rnd, PVC	BI	1	20	\$9.24
866-S2I	4-7/8" Diameter, Rnd, Cast Iron	BI	1	10	\$12.20
<b>STRAINERS FOR 9X9 DRAINS</b>					
866-3S	7-3/4" Diameter, Rnd, PVC	BI	1	20	\$13.29
866-S3I	6-3/4" Diameter, Rnd, Cast Iron	BI	1	10	\$20.31

### Strainers for City-Style Drains

Item Number	Item Description	Pkg Type	Min Qty	Case Qty	Price
<b>PITTSBURGH STYLE</b>					
844-S4	6-3/4" Diameter, Rnd Epoxy Coated Cast Iron	BI	1	40	\$10.51
<b>ST. LOUIS STYLE</b>					
844-02G	4-7/16" Diameter, Rnd Epoxy Coated Cast Iron	BI	1	10	\$7.97
844-04G	8-5/8" Diameter, Rnd Epoxy Coated Cast Iron	BI	1	10	\$22.46
844-0G	6-3/8" Diameter, Rnd Epoxy Coated Cast Iron	BI	1	10	\$10.88



**Strainers for City-Style Drains (Cont)**

Item Number	Item Description	Pkg Type	Min Qty	Case Qty	Price
<b>PHILADELPHIA STYLE</b>					
869-SV4	6" Diameter, Rnd Epoxy Coated Cast Iron w/ Set Screw	Bl	10	10	\$22.23



869-SV4

**General-Purpose Cast Iron Strainers**

Item Number	Item Description	Pkg Type	Min Qty	Case Qty	Price
846-S11PK	6-5/8" Diameter	Cl	3	3	\$14.14
846-S13PK	6-7/8" Diameter	Cl	3	3	\$15.29
846-S15PK	7" Diameter	Cl	3	3	\$15.71
846-S17PK	8" Diameter	Cl	3	3	\$20.01
846-S19PK	8-7/8" Diameter	Cl	3	3	\$27.47
846-S1PK	4-3/8" Diameter	Cl	3	3	\$7.06
846-S3PK	5" Diameter	Cl	3	3	\$7.46
846-S5PK	6" Diameter	Cl	3	3	\$11.38
846-S7PK	6-1/4" Diameter	Cl	3	3	\$12.17
846-S9PK	6-1/2" Diameter	Cl	3	3	\$13.34



846-S1PK

Supply

Drainage

Support

Specialties

Appendix



# Closet Flanges

**Knockout Closet Flanges**

**Open Closet Flanges**

**Push-In Closet Flanges**

**Offset Closet Flanges**

**Specialty Flanges**

**Repair Rings**



Sioux Chief offers one of the most complete and innovative lines of closet flanges in the industry with models available to suit almost any application.



**883-PT**  
Page 437



**884-PTM**  
Page 437



**886-P**  
Page 438



**887-PM**  
Page 438



**886-GP**  
Page 439



**886-GI**  
Page 439



**889-POM**  
Page 440



**889-45PM**  
Page 440



**890-I42**  
Page 441



**868-7P**  
Page 441



**886-MR**  
Page 442



**886-R**  
Page 442



**886-ER**  
Page 442

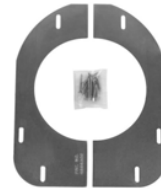

**490-11322**  
Page 443

**TKO™**

**PVC/ABS Sch. 40 Connection**

**Related Products**

Closet Specialties p 631

Item Number	Item Description	Pkg Type	Min Qty	Case Qty	Price
<b>ONE-PIECE PLASTIC RING</b>					
883-AT	3" Hub/Inside 4", ABS, Flush To Floor	BI	25	25	\$4.67
883-ATPK	3" Hub/Inside 4", ABS, Flush To Floor	CI	8	8	\$5.17
883-PT	3" Hub/Inside 4", PVC, Flush To Floor	BI	25	25	\$4.67
883-PTPK	3" Hub/Inside 4", PVC, Flush To Floor	CI	8	8	\$5.17
886-PT30	3" Sch 30 Hub, PVC	BI	25	25	\$7.32
<b>STAINLESS STEEL SWIVEL RING</b>					
884-ATM	3" Hub/Inside 4", ABS, Flush To Floor, 2-1/2" Tailpiece	BI	24	24	\$9.66
884-ATMPK	3" Hub/Inside 4", ABS, Flush To Floor, 2-1/2" Tailpiece	CI	8	8	\$10.16
884-PTM	3" Hub/Inside 4", PVC, Flush To Floor, 2-1/2" Tailpiece	BI	24	24	\$9.66
884-PTMPK	3" Hub/Inside 4", PVC, Flush To Floor, 2-1/2" Tailpiece	CI	8	8	\$10.16
886-4ATM	4" Hub, ABS, Flush To Floor	BI	25	25	\$12.97
886-4ATMPK	4" Hub, ABS, Flush To Floor	CI	8	8	\$13.47
886-4ATMSPK	4" Spigot, ABS, Flush To Floor	CI	8	8	\$13.47
886-4PTM	4" Hub, PVC, Flush To Floor	BI	25	25	\$12.97
886-4PTMPK	4" Hub, PVC, Flush To Floor	CI	8	8	\$13.47
886-4PTMSPK	4" Spigot, PVC, Flush To Floor	CI	8	8	\$13.47
886-ATMS	3" Spigot, ABS	BI	25	25	\$14.83
886-ATMSPK	3" Spigot, ABS	CI	8	8	\$15.33
886-PTM30	3" Sch 30 Hub, PVC	BI	25	25	\$12.24
886-PTMS	3" Spigot, PVC	BI	25	25	\$14.83
886-PTMSPK	3" Spigot, PVC	CI	8	8	\$15.33
888-ATM	Inside 3", ABS	BI	25	25	\$9.20
888-ATMPK	Inside 3", ABS	CI	8	8	\$9.70
888-PTM	Inside 3", PVC	BI	25	25	\$9.20
888-PTMPK	Inside 3", PVC	CI	8	8	\$9.70



883-AT



884-PTM

Supply

Drainage

Support

Specialties

Appendix

## Open Flanges

## PVC/ABS Sch. 40 Connection



886-4P



888-AM

Item Number	Item Description	Pkg Type	Min Qty	Case Qty	Price
<b>ONE-PIECE PLASTIC RING</b>					
886-4A	4" Hub, ABS, Flush To Floor	BI	25	25	\$7.50
886-4P	4" Hub, PVC, Flush To Floor	BI	25	25	\$7.50
886-4PPK	4" Hub, PVC, Flush To Floor	CI	6	6	\$8.00
886-A	3" Hub/Inside 4", ABS, Flush To Floor	BI	20	20	\$3.59
886-APK	3" Hub/Inside 4", ABS, Flush To Floor	CI	10	10	\$4.09
886-P	3" Hub/Inside 4", PVC, Flush To Floor	BI	20	20	\$3.59
886-PPK	3" Hub/Inside 4", PVC, Flush To Floor	CI	10	10	\$4.09
888-A	Inside 3", ABS	BI	20	20	\$5.79
888-APK	Inside 3", ABS	CI	10	10	\$6.29
888-P	Inside 3", PVC	BI	20	20	\$5.79
888-PPK	Inside 3", PVC	CI	10	10	\$6.29
<b>STAINLESS STEEL SWIVEL RING</b>					
886-4AM	4" Hub, ABS, Flush To Floor	BI	25	25	\$12.59
886-4AMSPK	4" Spigot, ABS, Flush To Floor	CI	6	6	\$13.09
886-4PM	4" Hub, PVC, Flush To Floor	BI	25	25	\$12.59
886-4PMSPK	4" Spigot, PVC, Flush To Floor	CI	6	6	\$13.09
887-AM	3" Hub/Inside 4", ABS, Flush To Floor	BI	25	25	\$9.36
887-PM	3" Hub/Inside 4", PVC, Flush To Floor	BI	25	25	\$9.36
888-AM	Inside 3", ABS, Flush To Floor	BI	12	12	\$13.33
888-PM	Inside 3", PVC, Flush To Floor	BI	12	12	\$13.33

Supply

Drainage

Support

Specialties

Appendix

**PushTite™**

**Inside-Pipe Gasket Connection**

**Related Products**

PlumbPerfect™ Closet Bolts p 631

Item Number	Item Description	Pkg Type	Min Qty	Case Qty	Price
<b>INSIDE 3" DWV PIPE</b>					
888-GAM	Black ABS	BI	6	6	\$32.86
888-GPM	White ABS	CI	6	6	\$32.86
<b>INSIDE 4" DWV PIPE</b>					
886-GA	Black ABS	BI	5	5	\$31.01
886-GI	Cast Iron	CI	5	5	\$59.31
886-GP	White ABS	CI	5	5	\$31.01
887-GAM	Black ABS - SS Swivel Ring	BI	6	6	\$27.36
887-GPM	White ABS - SS Swivel Ring	CI	6	6	\$27.36
887-GPTMK	PushTite Kit: 886-GP, Wax Ring, Closet Bolts, & Shims	CI	1	1	\$41.76



888-GPM



886-GI

Supply

Drainage

Support

Specialties

Appendix

Supply

Drainage

Support

Specialties

Appendix



889-AOM



889-POTM



889-GPOM



889-45AM

**FullFlush™**

**PVC/ABS Sch. 40 Hub Connection**

Item Number	Item Description	Pkg Type	Min Qty	Case Qty	Price
<b>OPEN OFFSET</b>					
889-AOM	3" Hub/Inside 4", ABS	BI	20	20	\$15.13
889-AOMPK	3" Hub/Inside 4", ABS	CI	6	6	\$15.63
889-POM	3" Hub/Inside 4", PVC	BI	20	20	\$15.13
889-POMPK	3" Hub/Inside 4", PVC	CI	6	6	\$15.63
<b>TKO™ OFFSET</b>					
889-AOTM	3" Hub/Inside 4", ABS	BI	20	20	\$16.20
889-POTM	3" Hub/Inside 4", PVC	BI	20	20	\$16.20

**FullFlush™**

**Inside-Pipe Gasket Connection**

Item Number	Item Description	Pkg Type	Min Qty	Case Qty	Price
889-GAOM	Inside 4", ABS	BI	5	5	\$36.01
889-GPOM	Inside 4", PVC	BI	5	5	\$36.01

**DropKick™**

**PVC/ABS Sch. 40 Spigot Connection**

Item Number	Item Description	Pkg Type	Min Qty	Case Qty	Price
889-45AM	3", ABS	BI	20	20	\$21.60
889-45AMPK2	3", ABS	CI	6	6	\$22.10
889-45PM	3", PVC	BI	20	20	\$21.60
889-45PMPK2	3", PVC	CI	6	6	\$22.10



**Cast Iron Closet Flanges**

**4" Compression Gasket Connection**

Item Number	Item Description	Pkg Type	Min Qty	Case Qty	Price
890-142	Over 4" Comp., Cast Iron	BI	4	4	\$30.32



890-142

**Brass Closet Flange Rings**

**for Lead Pipe Connection**

Item Number	Item Description	Pkg Type	Min Qty	Case Qty	Price
890-4BDPK	Over 4" Lead, Cast Brass	CI	10	10	\$41.32
890-4BPK	Over 4" Lead, Cast Brass	CI	10	10	\$30.74



890-4BDPK

**Urinal Flange Kit**

**2" PVC/ABS Sch. 40 Connection**

Item Number	Item Description	Pkg Type	Min Qty	Case Qty	Price
868-5A	2" Hub, ABS	BI	10	10	\$17.86
868-5P	2" Hub, PVC	BI	10	10	\$17.86
868-7A	Inside 2", ABS	BI	10	10	\$17.27
868-7P	Inside 2", PVC	BI	10	10	\$17.27
868-9A	2" Spigot, ABS	BI	10	10	\$16.96
868-9P	2" Spigot, PVC	BI	10	10	\$16.96



868-5A

Supply

Drainage

Support

Specialties

Appendix

Supply

Drainage

Support

Specialties

Appendix



886-MR

**Ringer™**

**Stainless Steel Repair Ring**

**Related Products**

Closet Repair Items - Bolts, Caps, Shims, Wax, Etc. p 631

Item Number	Item Description	Pkg Type	Min Qty	Case Qty	Price
886-MR	Stnls Steel Closet Ring	CI	20	20	\$8.24



886-MRM

**Two-Piece Repair Ring**

**Galvanized Steel Repair Ring**

Item Number	Item Description	Pkg Type	Min Qty	Case Qty	Price
886-MRM	Two-Piece Flange Repair Ring Kit, 1/Card	CI	8	8	\$24.67

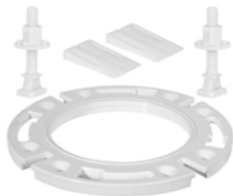

886-411

**Raise-A-Ring™**

**Closet Flange Extension Ring**

Item Number	Item Description	Pkg Type	Min Qty	Case Qty	Price
886-411	Raise-A-Ring Kit: One 886-R Ring w/ Closet Bolts And Two Shims, Bagged	CI	20	20	\$7.16
886-R	7/16" Thick Flange Extension Ring, Carded	CI	20	20	\$4.49
886-RQ	1/4" Thick Flange Extension Ring	CI	20	20	\$3.12
886-RQK	Raise-A-Ring Kit: Three 886-Rq Rings w/ Closet Bolts, Bagged	BI	25	25	\$10.53



886-ER

**QuickSpacer™**

**Closet Flange Spacer Ring**

Item Number	Item Description	Pkg Type	Min Qty	Case Qty	Price
886-ER	3/4" Closet Flange Spacer Ring	BI	25	25	\$2.89



490-11320

**Save-A-Flange™**

**Broken Flange Repair Kit**

Item Number	Item Description	Pkg Type	Min Qty	Case Qty	Price
490-11320	Closet Flange Repair Kit	BI	1	10	\$7.76

### Closet Flange Floor Support Galvanized Steel Support Plates

Item Number	Item Description	Pkg Type	Min Qty	Case Qty	Price
490-11322	Floor Flange Support For Closet Flange, 1/Bag	Cl	1	10	\$24.31

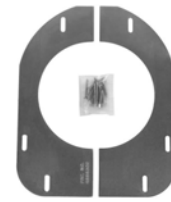

490-11322

Supply

Drainage

Support

Specialties

Appendix



# Backwater Valves

**ProCheck™ Shallow/Deep Access**

**Shallow Access**

**Accessories**



The ProCheck™ backwater valve is adaptable for shallow or deep-bury applications. The unique flapper also creates a much tighter seal than other backwater valves.



**ProCheck™**

**PVC/ABS Sch. 40 Hub Connection**

· For horizontal installations only

Item Number	Item Description	Pkg Type	Min Qty	Case Qty	Price
<b>PVC/ABS SCH. 40 HUB CONNECTION</b>					
869-S3A	3" ABS Hub	BI	4	4	\$49.84
869-S3APK	3" ABS Hub	CI	2	2	\$52.34
869-S3AS	3" ABS Hub w/ Shallow Access Sleeve Kit	BI	1	1	\$86.01
869-S3P	3" PVC Hub	BI	4	4	\$49.84
869-S3PPK	3" PVC Hub	CI	2	2	\$52.34
869-S3PS	3" PVC Hub w/ Shallow Access Sleeve Kit	BI	1	1	\$86.01
869-S4A	4" ABS Hub	BI	4	4	\$63.42
869-S4APK	4" ABS Hub	CI	2	2	\$65.92
869-S4AS	4" ABS Hub w/ Shallow Access Sleeve Kit	BI	1	1	\$98.55
869-S4P	4" PVC Hub	BI	4	4	\$63.42
869-S4PPK	4" PVC Hub	CI	2	2	\$65.92
869-S4PS	4" PVC Hub w/ Shallow Access Sleeve Kit	BI	1	1	\$98.55
<b>ACCESSORIES</b>					
869-S4ADB	ABS Deep-Bury Adapter Kit	BI	1	1	\$75.51
869-S4PDB	PVC Deep-Bury Adapter Kit	BI	1	1	\$75.51
869-SF3	Flapper & Carrier For 3" Backwater Valve	BI	10	10	\$13.20
869-SF4	Flapper & Carrier For 4" Backwater Valve	BI	10	10	\$15.04
869-SSK	Shallow Access Sleeve Kit - Collar/Sleeve/Lid	BI	1	1	\$66.63
869-SSL	Turn-Lock Collar & Lid For 16" Shallow Access Sleeve	BI	4	4	\$16.89
869-SVLB	Threaded Lid For Backwater Valve, Black w/ O-Ring	BI	10	10	\$9.08
869-SVLW	Threaded Lid For Backwater Valve, White w/ O-Ring	BI	10	10	\$9.08



869-S3P



869-S4AS



869-S4ADB

Supply

Drainage

Support

Specialties

Appendix



869-2P



869-23



803-2PK2

## DWV Backwater Valve

### PVC/ABS Sch. 40 Hub Connection

· For horizontal installations only

Item Number	Item Description	Pkg Type	Min Qty	Case Qty	Price
<b>PVC/ABS SCH. 40 HUB CONNECTION</b>					
869-2A	2" ABS Hub	BI	1	8	\$35.12
869-2P	2" PVC Hub	BI	1	8	\$35.12
869-2PS	2" PVC Hub w/ Extension Sleeve Kit	BI	1	1	\$44.59
869-6P	6" PVC Hub	B	1	1	\$268.65
<b>ACCESSORIES</b>					
869-23	Extension Sleeve Kit For 2" Valve; Includes Sleeve, Locking Collar And Lid	BI	1	1	\$22.03
869-60	O-Ring For 6" Threaded Lid	BI	1	10	\$18.26
869-61	Flapper & O-Ring For 6" Valve	BI	1	10	\$44.10
869-6P1	6" White PVC Threaded Lid	BI	1	2	\$106.59

## Backup Float Valve

### Inside-Pipe Compression Connection

· For vertical installations only

Item Number	Item Description	Pkg Type	Min Qty	Case Qty	Price
803-2PK2	2" Backup Float Valve, Bagged	CI	12	12	\$51.91
803-3PK2	3" Backup Float Valve, Bagged	CI	12	12	\$34.02
803-4PK2	4" Backup Float Valve, Bagged	CI	12	12	\$39.99



# Air Admittance Valves

**TurboVent™**

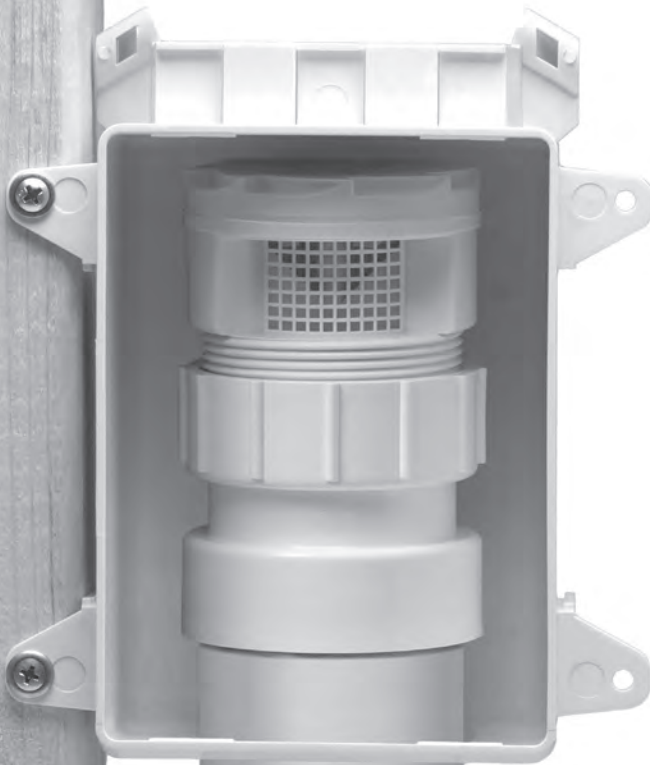

Sioux Chief's TurboVent™ is designed for reliability with a self-cleaning seal and engineered for performance in branch or stack applications.

The unique design responds quickly to allow air into the DWV system and seals positively to prevent sewer gas from entering the living space.



**MIP Thread Connection**

**Contractor Packs**

- Actuating device within the unit spins with activation, keeping the seal free of dust and debris
- Quick opening at .01" negative pressure. Positive seal with 13 psig of back pressure
- Seal threads with PTFE tape - Do Not use pipe dope.
- Install upright/vertically, in accessible locations only.



250-11

Item Number	Item Description	Pkg Type	Min Qty	Case Qty	Price
250-11	TurboVent™ AAV Only - 1-1/2" MIP Adapter, 6/Bag	BI	1	4	\$113.42
250-12	TurboVent™ AAV Only - 2" MIP Adapter, 6/Bag	BI	1	4	\$113.42

Supply

Drainage

Support

Specialties

Appendix

**PVC Sch. 40 Hub Connection**

- Actuating device within the unit spins with activation, keeping the seal free of dust and debris
- Quick opening at .01" negative pressure. Positive seal with 13 psig of back pressure
- Seal threads with PTFE tape - Do Not use pipe dope.
- Install upright/vertically, in accessible locations only.



250-11P



250-122PB



250-11PC



250-11TW



250-696122P

Item Number	Item Description	Pkg Type	Min Qty	Case Qty	Price
<b>INDIVIDUALLY BOXED</b>					
250-11P	TurboVent™ AAV w/ 1-1/2" Adapter	BI	1	6	\$25.73
250-122P	TurboVent™ AAV w/ 1-1/2" - 2" Dual Fit Adapter	BI	1	6	\$26.93
250-12P	TurboVent™ AAV w/ 2" Adapter	BI	1	6	\$26.93
<b>BULK PACK</b>					
250-122PB	TurboVent™ AAV w/ 1-1/2" - 2" Dual Fit Adapter	BI	50	50	\$20.04
<b>CONTRACTOR PACKS</b>					
250-11PC	TurboVent™ AAV w/ 1-1/2" Adapter, 6/Bag	BI	1	8	\$123.83
250-122PC	TurboVent™ AAV w/ 1-1/2" - 2" Dual Fit Adapter, 6/Bag	BI	1	8	\$123.83
250-12PC	TurboVent™ AAV w/ 2" Adapter, 6/Bag	BI	1	8	\$123.83
<b>TUBULAR CONNECTION KIT</b>					
250-11TW	TurboVent™ AAV w/ 1-1/2" MIP Adapter & Tubular Waste Arm Extension	CI	1	6	\$31.71
<b>WITH OXBOX™ ACCESS BOX</b>					
250-696122P	TurboVent™ AAV w/ 1-1/2" - 2" Dual Fit Adapter & OxBox™ Kit	BI	1	6	\$34.11
250-696R122P	TurboVent™ AAV w/ 1-1/2" - 2" Dual Fit Adapter & Fire Rated OxBox™ Kit	BI	1	6	\$86.74
696-11P	TurboVent™ AAV w/ 1-1/2" Hub Adapter & OxBox™ Kit	BI	1	6	\$35.65
696-12P	TurboVent™ AAV w/ 2" Hub Adapter & OxBox™ Kit	BI	1	6	\$36.65

Supply

Drainage

Support

Specialties

Appendix

## ABS Sch. 40 Hub Connection

- Do not use pipe dope
- Actuating device within the unit spins with activation, keeping the seal free of dust and debris
- Quick opening at .01" negative pressure. Positive seal with 13 psig of back pressure
- Protective debris cover ships with each unit

Item Number	Item Description	Pkg Type	Min Qty	Case Qty	Price
<b>INDIVIDUALLY BOXED</b>					
250-11A	TurboVent™ AAV w/ 1-1/2" Adapter	BI	1	6	\$25.73
250-12A	TurboVent™ AAV w/ 2" Adapter	BI	1	6	\$26.93
<b>BULK PACK</b>					
250-122AB	TurboVent™ AAV w/ 1-1/2" - 2" Dual Fit Adapter	BI	50	50	\$20.04
<b>CONTRACTOR PACKS</b>					
250-11AC	TurboVent™ AAV w/ 1-1/2" Adapter, 6/Bag	BI	1	8	\$123.83
250-122AC	TurboVent™ AAV w/ 1-1/2" - 2" Dual Fit Adapter, 6/Bag	BI	1	8	\$123.83
250-12AC	TurboVent™ AAV w/ 2" Adapter, 6/Bag	BI	1	8	\$123.83
<b>TUBULAR CONNECTION KIT</b>					
250-11TB	TurboVent™ AAV w/ 1-1/2" MIP Adapter	CI	1	6	\$31.71
<b>WITH OXBOX™ ACCESS BOX</b>					
250-696122A	TurboVent™ AAV w/ 1-1/2" - 2" Dual Fit Adapter	BI	1	6	\$34.11
<b>250-696R122A</b>	TurboVent™ AAV w/ 1-1/2" - 2" Dual Fit Adapter	BI	1	6	\$86.74
696-11A	TurboVent™ AAV w/ 1-1/2" Hub Adapter & OxBox™ Kit	BI	1	6	\$35.65
696-12A	TurboVent™ AAV w/ 2" Hub Adapter & OxBox™ Kit	BI	1	6	\$36.65

## Accessories

Item Number	Item Description	Pkg Type	Min Qty	Case Qty	Price
696-1F	Single Frame For OxBox™	B	10	10	\$2.30
696-7	OxBox - Single Box w/ Hole For 2" Sch. 40 Pipe	B	10	10	\$5.91
696-LC	Louvered Frame Insert	B	10	10	\$4.73
<b>842-712A</b>	1-1/2" - 2" ABS Hub × 2" FIP Dual Fit Adapter	BI	10	10	\$3.52
842-712P	1-1/2" - 2" PVC Hub × 2" FIP Dual Fit Adapter	BI	10	10	\$3.52



250-122AB



250-12AC



250-696122A



842-712P

Supply

Drainage

Support

Specialties

Appendix



# Residential Accessories

The SmartSaddle™ allows a new DWV line to be retro-fit into an existing 3" or 4" stack. The low-profile design uses stainless steel bands, making it perfect for stacks close to walls or other obstructions







**SmartSaddle™**

Item Number	Item Description	Pkg Type	Min Qty	Case Qty	Price
891-0312P	3" Sch. 40 Trunk, 1-1/2" Hub × 2" Spgt.	Cl	5	5	\$18.73
891-033P	3" Sch. 40 Trunk, 3" Hub × 4" Inside Fit	Cl	5	5	\$19.78
891-0412P	4" Sch. 40 Trunk, 1-1/2" Hub × 2" Spgt.	Cl	5	5	\$20.14
891-043P	4" Sch. 40 Trunk, 3" Hub × 4" Inside Fit	Cl	5	5	\$21.91
891-044P	4" Sch. 40 Trunk, 4" Hub	Cl	5	5	\$22.25



891-0312P

**Condensate Trap**

Item Number	Item Description	Pkg Type	Min Qty	Case Qty	Price
867-30PK	P-Trap, 8" Long × 2-1/2" Drop	Cl	25	25	\$4.83
867-35PK	Running Trap, 10-3/4 Long × 2" Drop	Cl	25	25	\$4.83



867-30PK

**PVC Vent Cap**

Item Number	Item Description	Pkg Type	Min Qty	Case Qty	Price
869-V34	Fits Over 3" Or 4" DWV Pipe w/ Two Set Screws	Cl	4	4	\$19.97



869-V34

**Pipe Bore Adapter**

Item Number	Item Description	Pkg Type	Min Qty	Case Qty	Price
880	4" To 6" Rolling O-Ring Adapter	B	25	25	\$13.22



880

Supply

Drainage

Support

Specialties

Appendix



# **Testing**

**Test Devices**

**Gauges & Accessories**

# Testing

## Test Devices

Test devices designed to seal the DWV system temporarily, for pressure tests, or permanently to provide occasional access to the system for maintenance. Mechanical, inflatable, and glue-on devices available.

## Gauges & Accessories

A variety of pressure gauges are available for both testing or permanent installation. Test assemblies combine gauges with convenient fittings for easy connection.

# Test Devices

**TestTitan™**

**T-Cone™**

**TeePee™**

**GripTip™**

**HardHat™**

**Flexible Test Caps**

**Knockout Test Plugs**

**QuickPlug™**

**Shower Arm  
Test Plug**





**882-2P**  
Page 463



**882-ST302**  
Page 463



**882-95**  
Page 464



**881-54**  
Page 464



**882-TT2**  
Page 464



**882-ES34**  
Page 465



**880-81**  
Page 465



**881-10C**  
Page 465



**881-02H**  
Page 465



**880-01P**  
Page 466



**880-1**  
Page 466



**881-3**  
Page 466



**880-012**  
Page 466



**234-QP2**  
Page 467



**988-6GT**  
Page 465



**882-647**  
Page 467

**TestTitan™**

**Mechanical Test Plug**

· Not intended for permanent use

Item Number	Item Description	Pkg Type	Min Qty	Case Qty	Price
<b>PIPE &amp; CLEANOUT PLUGS</b>					
882-1	1-1/2", for DWV Pipe/FIP Threads	Cl	10	10	\$4.55
882-2	2", for DWV Pipe/FIP Threads	Cl	10	10	\$4.55
882-3	3", for DWV Pipe/FIP Threads	Cl	10	10	\$6.84
882-35	3-1/2", for FIP Threads	Cl	10	10	\$8.46
882-4	4", for DWV Pipe/FIP Threads	Cl	10	10	\$8.46
882-41	4", for FIP Threads	Cl	10	10	\$11.07
<b>PNEUMATIC TEST PLUGS WITH AIR VALVE</b>					
882-1P	1-1/2", for DWV Pipe/FIP Threads	B	10	10	\$17.55
882-2P	2", for DWV Pipe/FIP Threads	B	10	10	\$17.55
882-3P	3", for DWV Pipe/FIP Threads	B	10	10	\$19.84
882-4P	4", for DWV Pipe/FIP Threads	B	10	10	\$21.47
<b>ACCESSORIES</b>					
882-115	Brass Fill & Drain Valve - FHT × FHT	Bl	1	25	\$28.06



882-1



882-2P

**T-Cone™**

**Mechanical Test Plug**

· Not intended for permanent use

Item Number	Item Description	Pkg Type	Min Qty	Case Qty	Price
<b>PIPE PLUGS</b>					
882-CS202	2" Flush-Head Pipe Plug, 2.067" Gasket O.D.	B	10	100	\$5.46
882-CS302	3" Flush-Head Pipe Plug, 3.068" Gasket O.D.	B	10	100	\$6.51
882-CS402	4" Flush-Head Pipe Plug, 4.026" Gasket O.D.	B	10	100	\$10.32
882-ST152	1-1/2" Raised-Head Pipe Plug, 1.61" Gasket O.D.	B	10	100	\$5.85
882-ST202	2" Raised-Head Pipe Plug, 2.067" Gasket O.D.	B	10	100	\$5.85
882-ST302	3" Raised-Head Pipe Plug, 3.068" Gasket O.D.	B	10	100	\$6.98
882-ST402	4" Raised-Head Pipe Plug, 4.026" Gasket O.D.	B	10	100	\$11.08
882-ST602	6" Raised-Head Pipe Plug, 6.065" Gasket O.D.	B	10	10	\$17.35
882-ST802	8" Raised-Head Pipe Plug, 7.981" Gasket O.D.	B	10	10	\$35.90
<b>SOCKET-FIT PLUGS</b>					
882-ST300	3" Raised-Head Socket Plug, 3.50" Gasket O.D.	B	10	100	\$8.52
<b>CLEANOUT PLUGS</b>					
882-EB152	1-1/2" Raised-Head Cleanout Plug, 1.78" Gasket O.D.	B	10	100	\$5.46
882-EB220	2" Raised-Head Cleanout Plug, 2.255" Gasket O.D.	B	10	100	\$5.46
882-EB320	3" Raised-Head Cleanout Plug, 3.378" Gasket O.D.	B	10	100	\$8.74
882-EB350	3-1/2" Raised-Head Cleanout Plug, 3.85" Gasket O.D.	B	10	100	\$10.58
882-EB420	4" Raised-Head Cleanout Plug, 4.336" Gasket O.D.	B	10	100	\$11.89



882-CS302



882-ST302

Supply

Drainage

Support

Specialties

Appendix



882-96

### HandTite™

#### Mechanical Test Plug

· Not intended for permanent use

Item Number	Item Description	Pkg Type	Min Qty	Case Qty	Price
882-95	5" Test Plug	B	1	30	\$42.92
882-96	6" Test Plug	B	1	30	\$46.83
882-98	8" Test Plug	B	1	12	\$101.45



881-54

### TeePee™

#### Mechanical Test Tool

Item Number	Item Description	Pkg Type	Min Qty	Case Qty	Price
<b>CLEANOUT TEE TEST TOOL</b>					
881-52	2" Mechanical Test Tool	B	1	5	\$71.54
881-53	3" Mechanical Test Tool	B	1	5	\$81.29
881-54	4" Mechanical Test Tool	B	1	1	\$94.31
881-56	6" Mechanical Test Tool	B	1	1	\$260.12
881-58	8" Mechanical Test Tool	B	1	1	\$608.03
881-510	10" Mechanical Test Tool	B	1	1	\$786.87
<b>REPLACEMENT SEAL</b>					
881-01-2	2" Plug Replacement Seal	BI	5	5	\$29.27
881-01-3	3" Plug Replacement Seal	BI	5	5	\$39.03
881-01-4	4" Plug Replacement Seal	BI	5	5	\$48.79
<b>881-01-6</b>	6" Plug Replacement Seal	BI	1	5	\$71.54
<b>881-01-8</b>	8" Plug Replacement Seal	BI	2	2	\$96.39
<b>881-01-10</b>	10" Plug Replacement Seal	B	1	1	\$175.34



882-TT2

### Inflatable Cleanout Tee Plug

· Max test pressure: 5 PSIG air, 30 FT-HD

Item Number	Item Description	Pkg Type	Min Qty	Case Qty	Price
882-TT2	2" Inflatable Plug	BI	1	48	\$66.58
882-TT3	3" Inflatable Plug	BI	1	18	\$74.01
882-TT4	4" Inflatable Plug	BI	1	8	\$85.51



## Inflatable Test Plug

• Max test pressure: 10 PSIG air, 30 FT-HD

Item Number	Item Description	Pkg Type	Min Qty	Case Qty	Price
<b>SINGLE-STAGE PLUG</b>					
882-ES12	1 1/2"-2" × 5 1/2" Long For 1.17" - 2.25" Pipe	Bl	1	1	\$62.63
882-ES23	2"-3" × 5" Long For 1.75" - 3.25" Pipe	Bl	1	1	\$66.11
882-ES34	3"-4" × 7 1/4" Long For 2.88" - 4.25" Pipe	Bl	1	1	\$66.11
882-ES46	4"-6" × 10 1/4" Long For 3.77" - 6.25" Pipe	Bl	1	1	\$149.61
<b>DUAL-STAGE PLUG</b>					
882-EL23	2"-3" × 22" Long For 1.75" - 3.25" Pipe	Bl	1	1	\$173.96
882-EL34	3"-4" × 25" Long For 2.88" - 4.25" Pipe	Bl	1	1	\$208.75
882-EL46	4"-6" × 29 1/2" Long For 3.77" - 6.25" Pipe	Bl	1	1	\$417.49



882-ES34

## GripTip™

• Not intended for permanent use

Item Number	Item Description	Pkg Type	Min Qty	Case Qty	Price
<b>OVER-PIPE TEST CAPS</b>					
880-81	1-1/2" Test Cap, White	B	25	200	\$0.48
880-81C	1-1/2" Test Cap, Magenta	B	25	200	\$0.51
880-81PK	1-1/2" Test Cap, White	Cl	50	50	\$0.73
880-82	2" Test Cap, White	B	25	100	\$0.54
880-82C	2" Test Cap, Magenta	B	25	100	\$0.57
880-82PK	2" Test Cap, White	Cl	50	50	\$0.79
880-83	3" Test Cap, White	B	10	50	\$0.88
880-83C	3" Test Cap, Magenta	B	10	50	\$0.90
880-83PK	3" Test Cap, White	Cl	25	25	\$1.13
880-84	4" Test Cap, White	B	10	50	\$1.07
880-84C	4" Test Cap, Magenta	B	10	50	\$1.09
880-84PK	4" Test Cap, White	Cl	25	25	\$1.32
<b>INSIDE-PIPE TEST PLUGS</b>					
881-10	1-1/2" Test Plug, White	B	25	200	\$0.45
881-10C	1-1/2" Test Plug, Magenta	B	25	200	\$0.49
881-12	2" Test Plug, White	B	25	100	\$0.52
881-12C	2" Test Plug, Magenta	B	25	100	\$0.54
881-13	3" Test Plug, White	B	10	50	\$0.69
881-13C	3" Test Plug, Magenta	B	10	50	\$0.73
881-14	4" Test Plug, White	B	10	50	\$0.93
881-14C	4" Test Plug, Magenta	B	10	50	\$0.95
<b>TUBULAR TEST NUT</b>					
230-9506GT	PVC 1-1/2 Hub Trap Adapter w/ GripTip Test Nut	B	25	25	\$1.73
988-6GT	1-1/2" Trap Adapter Nut w/ GripTip	B	25	25	\$0.88
<b>ACCESSORIES</b>					
881-02A	Air Test Fitting 15 PSI Gauge 5/8" O.D. Comp × Air Filler Valve	B	1	10	\$35.77
881-02FP	Replacement 5/8" Poly Ferrule	B	100	1000	\$0.77
881-02H	Water Test Valve 5/8" O.D. Comp × Female Swivel Hose Thread	B	1	25	\$22.11



880-81



881-10C



881-02A



881-02H



880-02A

### HardHat™

· Not intended for permanent use

Item Number	Item Description	Pkg Type	Min Qty	Case Qty	Price
<b>PVC TEST CAPS</b>					
880-01P	1-1/2" Sch. 40 Pipe	B	50	500	\$0.58
880-02P	2" Sch. 40 Pipe	B	25	500	\$0.58
880-03P	3" Sch. 40 Pipe	B	20	200	\$0.81
880-04P	4" Sch. 40 Pipe	B	25	100	\$0.90
<b>ABS TEST CAPS</b>					
880-01A	1-1/2" Sch. 40 Pipe	B	50	500	\$0.58
880-02A	2" Sch. 40 Pipe	B	25	500	\$0.58
880-03A	3" Sch. 40 Pipe	B	20	200	\$0.81
880-04A	4" Sch. 40 Pipe	B	25	100	\$0.90

### Flexible PVC Test Caps



880-1

Item Number	Item Description	Pkg Type	Min Qty	Case Qty	Price
880-1	1-1/2"	B	25	25	\$4.73
880-2	2"	B	25	25	\$4.92
880-3	3"	B	25	25	\$6.44
880-4	4"	B	25	25	\$7.80

### Knockout Test Plugs



881-3

Item Number	Item Description	Pkg Type	Min Qty	Case Qty	Price
881-1	1-1/2" Plug	B	100	1000	\$0.41
881-2	2" Plug	B	100	1000	\$0.52
881-3	3" Plug	B	50	500	\$0.78
881-4	4" Plug	B	50	500	\$0.89

### Dual-Fit Test Caps



880-012

Item Number	Item Description	Pkg Type	Min Qty	Case Qty	Price
880-012	1-1/2" And 2" Sch. 40 Cap	B	100	500	\$1.07
880-034	3" And 4" Sch. 40 Cap	B	50	250	\$1.83

**QuickPlug™**

Item Number	Item Description	Pkg Type	Min Qty	Case Qty	Price
234-QP	1-1/2" Trap Adapter Test Plug	B	25	100	\$1.09
234-QP2	1-1/4" Trap Adapter Test Plug	B	25	100	\$1.09



234-QP2

**GripTip™**

**Trap Adapter Test Nut**

Item Number	Item Description	Pkg Type	Min Qty	Case Qty	Price
988-6GT	1-1/2" Trap Adapter Nut w/ GripTip	B	25	25	\$0.88



988-6GT

**Shower Arm Test Plug**

Item Number	Item Description	Pkg Type	Min Qty	Case Qty	Price
882-647	1/2" MIP Reuseable Test Plug	Bl	6	24	\$3.36
882-647W	882-647 Replacement Washer, 25/Bag	B	1	20	\$9.06



882-647

Supply

Drainage

Support

Specialties

Appendix



# Gauges & Accessories

**Test Gauge Assemblies**

**Test Gauges**

**Hand Pump**





**Test Gauge Assemblies**

Item Number	Item Description	Pkg Type	Min Qty	Case Qty	Price
<b>FIP X AIR VALVE</b>					
355-05PK2	Air Valve Fitting Only, 3/4" FIP, Clamshell	Cl	1	10	\$15.23
355-15PK1	0-15 Lb. Gas Test Fitting, 3/4" FIP, Clamshell	Cl	1	10	\$42.30
355-30PK1	0-30 Lb. Gas Test Fitting, 3/4" FIP, Clamshell	Cl	1	10	\$42.30
355-60PK1	0-60 Lb. Gas Test Fitting, 3/4" FIP, Clamshell	Cl	1	10	\$42.30
355-100PK1	0-100 Lb. Gas Test Fitting, 3/4" FIP, Clamshell	Cl	1	10	\$31.10
<b>COMPRESSION X AIR VALVE</b>					
881-02A	Air Test Fitting 15 PSI Gauge 5/8" O.D. Comp x Air Filler Valve	B	1	10	\$35.77
882-110	Air Test Fitting 100 PSI Gauge 5/8" O.D. Comp x Air Filler Valve	B	1	6	\$36.74
<b>HOSE THREAD CONNECTION</b>					
360-300PK1	300 PSI Water Test Gauge	B	1	10	\$33.39
882-105	Air/Water Test Fitting 300 PSI Gauge, Female Swivel Hose Connections	B	1	6	\$88.12



355-15PK1



881-02A



882-105

**Test Gauges**

Item Number	Item Description	Pkg Type	Min Qty	Case Qty	Price
356-100PK1	0-100 PSI Pressure Gauge 1 Lb. Grad, Clamshell	Cl	1	10	\$19.02
356-300PK1	0-300 PSI Pressure Gauge 10 Lb. Grad, Clamshell	Cl	1	10	\$19.02
356-30PK1	0-30 PSI Pressure Gauge 1/2 Lb. Grad, Clamshell	Cl	1	10	\$19.02
356-60PK1	0-60 PSI Pressure Gauge 1 Lb. Grad, Clamshell	Cl	1	10	\$13.99
360-15PK1	0-15 PSI Pressure Gauge 1/2 Lb. Grad, Clamshell	Cl	1	10	\$19.02



356-100PK1

**Hand Pump**

Item Number	Item Description	Pkg Type	Min Qty	Case Qty	Price
882-EHPG	High-Pressure Hand Pump w/ Pressure Gauge	Bl	1	1	\$86.01



882-EHPG

Supply

Drainage

Support

Specialties

Appendix





# Support

Supply Hangers

DWV Hangers

Brackets



# **Supply Hangers**

**Plastic CTS**

**Metal CTS/IPS**

**Anchors & Fasteners**

# Supply Hangers

## Plastic CTS

Durable, engineered plastic clamps for CTS tubing. Unique and innovative designs, made from corrosion and impact resistant polymers to ensure long-lasting performance. All Plastic CTS hangers are 100% compatible with PEX, copper and CPVC.

## Metal CTS/IPS

Metal tubing hangers offer the strength, durability and heat-resistance of steel when required for specific applications. Copper and zinc plating protect against corrosion.

## Anchors & Fasteners

Anchors, screws, bands, and other hardware for use with supply hangers.

# Plastic CTS

**PickUp™ Talon, TubeTalon™, TwinTalon™**

**SiouxStrap™, PadLock™, Totem™, EZ Tube Clamp**

**EZ Suspension, EZ Glide Tube Insulator**

**Suspensulator™, PipeEye™, BiFolator,™**

**MainBlock™, TouchDown™**

**TD+™ Strut Clamp**

**HangsTuff Jr.™**

**Single Hole  
Tube Strap**





**556-3**  
Page 479



**555-2**  
Page 479



**555-23**  
Page 480



**551-3**  
Page 480



**551-P2Q**  
Page 481



**552-A2**  
Page 481



**559-2**  
Page 482



**557-2Q**  
Page 482

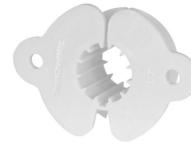

**558-2**  
Page 483



**558-E2**  
Page 483



**558-M23**  
Page 483



**558-23**  
Page 484



**550-11Q**  
Page 485



**550-2111**  
Page 485



**553-3W**  
Page 486



**500-2**  
Page 489



**550-02**  
Page 486



**523-32**  
Page 490



**506-34**  
Page 490



**512-36PK**  
Page 490



**590-10**  
Page 495



**590-4411**  
Page 495



**612-2S**  
Page 496



**554-608**  
Page 496



**574-72**  
Page 496

**PickUp Talon™**

**Isolating Drive Hook**

· Install in alternating directions to secure piping

Item Number	Item Description	Pkg Type	Min Qty	Case Qty	Price
<b>BLACK</b>					
556-2	1/2" CTS w/ Nail	B	100	1000	\$0.09
556-2BKT	1/2" CTS w/ Nail, 1800/bucket	B	1	1	\$169.60
556-2PK2	1/2" CTS w/ Nail, 10/Bag	Cl	10	10	\$1.67
556-2PK3	1/2" CTS w/ Nail, (Contr Pack), 100/Bag	Cl	1	10	\$9.95
556-2S	1/2" CTS w/ Screw	B	100	1000	\$0.41
556-3	3/4" CTS w/ Nail	B	100	1000	\$0.15
556-3BKT	3/4" CTS w/ Nail, 1000/bucket	B	1	1	\$151.00
556-3PK2	3/4" CTS w/ Nail, 10/Bag	Cl	10	10	\$2.22
556-3PK3	3/4" CTS w/ Nail, (Contr Pack), 100/Bag	Cl	1	10	\$14.70
556-3S	3/4" CTS w/ Screw	B	100	1000	\$0.47
556-4	1" CTS w/ Nail	B	50	500	\$0.42
556-4BKT	1" CTS w/ Nail, 500/bucket	B	1	1	\$214.00
556-4PK2	1" CTS w/ Nail, 10/Bag	Cl	10	10	\$4.95
556-4PK3	1" CTS w/ Nail, (Contr Pack), 50/Bag	Cl	1	10	\$21.00
556-5	1-1/4" CTS w/ Nail	B	250	250	\$0.75
556-5S	1-1/4" CTS w/ Screw	B	25	100	\$1.15
<b>IVORY</b>					
556-4C	1" CTS w/ Nail	B	50	500	\$0.41



556-2



556-2BKT



556-2C

**TubeTalon™**

**Drive Hook**

· Install in alternating directions to secure piping

Item Number	Item Description	Pkg Type	Min Qty	Case Qty	Price
555-1	3/8" CTS w/ Nail	B	100	1000	\$0.16
555-2	1/2" CTS w/ Nail	B	100	1000	\$0.09
555-2BKT	1/2" CTS w/ Nail, 2200/bucket	B	1	1	\$206.40
555-3	3/4" CTS w/ Nail	B	100	1000	\$0.17
555-3BKT	3/4" CTS w/ Nail, 1,100/bucket	B	1	1	\$191.00
555-4	1" CTS w/ Nail	B	50	500	\$0.43
555-4BKT	1" CTS w/ Nail, 600/bucket	B	1	1	\$262.00



555-2



555-2BKT

**TwinTalon™**

**Double-Duty Drive Hook**

Item Number	Item Description	Pkg Type	Min Qty	Case Qty	Price
555-23	1/2" - 3/4" CTS w/ Nail	B	100	1000	\$0.14
555-23BKT	1/2"-3/4" CTS w/ Nail, 950/bucket	B	1	1	\$140.80
555-23PK2	1/2" - 3/4" CTS w/ Nail, 10/Bag	CI	10	10	\$2.19
555-23PK3	1/2" - 3/4" CTS w/ Nail, (Contr Pack), 100/Bag	BI	1	10	\$14.40
555-23S	1/2" - 3/4" CTS w/ Screw	B	100	1000	\$0.43
555-623	1/2" - 3/4" CTS w/ Short 1-5/8" Nail	B	100	1000	\$0.25
555-623PK2	1/2" - 3/4" CTS w/ Short 1-5/8" Nail, 10/Bag	CI	10	10	\$3.21



555-23



555-23BKT

**SiouxStrap™**

**Full Clamp Tube Hanger**

Item Number	Item Description	Pkg Type	Min Qty	Case Qty	Price
<b>BLACK</b>					
551-2	1/2" CTS w/ Nail	B	100	1000	\$0.18
551-2BKT	1/2" CTS w/ Nail, 1200/bucket	B	1	1	\$218.80
551-2PK2	1/2" CTS w/ Nail, 10/Bag	CI	20	20	\$2.54
551-3	3/4" CTS w/ Nail	B	50	500	\$0.26
551-3BKT	3/4" CTS w/ Nail, 700/bucket	B	1	1	\$186.00
551-3PK2	3/4" CTS w/ Nail, 10/Bag	CI	20	20	\$3.35
551-4	1" CTS w/ Nail	B	25	250	\$0.62
551-4BKT	1" CTS w/ Nail, 400/bucket	B	1	1	\$252.00
551-4PK2	1" CTS w/ Nail, 10/Bag	CI	20	20	\$6.95
<b>IVORY</b>					
551-2C	1/2" CTS w/ Nail	B	100	1000	\$0.19
551-3C	3/4" CTS w/ Nail	B	50	500	\$0.26



551-2



551-3BKT



551-2C

Supply

Drainage

Support

Specialties

Appendix



**PadLock™**

**Full Clamp Tube Strap**

Item Number	Item Description	Pkg Type	Min Qty	Case Qty	Price
<b>STANDARD</b>					
551-P2	1/2" CTS w/ Nail	B	100	1000	\$0.25
551-P2PK3	1/2" CTS w/ Nail, (Contr Pack), 100/Bag	Cl	1	10	\$24.60
551-P2S	1/2" CTS w/ Screw	B	100	1000	\$0.42
551-P3	3/4" CTS w/ Nail	B	50	500	\$0.37
551-P3PK3	3/4" CTS w/ Nail, (Contr Pack), 50/Bag	Cl	1	10	\$18.50
551-P3S	3/4" CTS w/ Screw	B	50	500	\$0.58
<b>ACOUSTICAL</b>					
551-P2Q	1/2" CTS PipeDown™ Padlock™ w/ Drill Tip Screw	B	25	25	\$2.82
551-P3Q	3/4" CTS PipeDown™ Padlock™ w/ Drill Tip Screw	B	25	25	\$3.32
551-P4Q	1" CTS PipeDown™ Padlock™ w/ Drill Tip Screw	B	25	25	\$4.14
551-P5Q	1-1/4" CTS PipeDown™ Padlock™ w/ Drill Tip Screw, Contr Pack	B	25	25	\$5.22



551-P2



551-P2Q

**Totem™**

**Offset CTS Hanger**

Item Number	Item Description	Pkg Type	Min Qty	Case Qty	Price
<b>SINGLE</b>					
552-A2	1/2" CTS w/ Nail	B	50	50	\$0.30
552-A3	3/4" CTS w/ Nail	B	50	50	\$0.38
<b>TWIN</b>					
552-B22	1/2" × 1/2" CTS w/ Nail	B	50	50	\$0.41
552-B23	1/2" × 3/4" CTS w/ Nail	B	50	50	\$0.44
552-B33	3/4" × 3/4" CTS w/ Nail	B	50	50	\$0.47
<b>STACKED</b>					
552-C22	1/2" × 1/2" CTS w/ Nail	B	50	50	\$0.41
552-C23	1/2" × 3/4" CTS w/ Nail	B	50	50	\$0.44
552-C33	3/4" × 3/4" CTS w/ Nail	B	50	50	\$0.47



552-A2



552-B23



552-C22

Supply

Drainage

Support

Specialties

Appendix

**EZ Glide™ Tube Clamp**

**Tube Clamp**



559-2

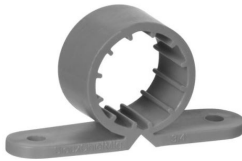

559F3

Item Number	Item Description	Pkg Type	Min Qty	Case Qty	Price
<b>STANDARD</b>					
559-2	1/2" CTS	B	100	1000	\$0.31
559-2PK2	1/2" CTS, 5/Bag	CI	10	10	\$2.30
559-3	3/4" CTS	B	50	1000	\$0.32
559-3PK2	3/4" CTS, 5/Bag	CI	10	10	\$2.35
559-4	1" CTS	B	50	500	\$0.71
559-4PK2	1" CTS, 5/Bag	CI	10	10	\$4.30
559-5	1-1/4" CTS	B	25	250	\$0.91
559-5PK2	1-1/4" CTS, 5/Bag	CI	10	10	\$5.30
559-6	1-1/2" CTS	B	25	250	\$1.44
559-6PK2	1-1/2" CTS, 5/Bag	CI	10	10	\$7.95
559-7	2" CTS	B	25	250	\$1.58
559-7PK2	2" CTS, 5/Bag	CI	10	10	\$8.65
<b>PLENUM-RATED</b>					
559F2	E84 1/2" CTS	B	100	1000	\$1.72
559F3	E84 3/4" CTS	B	50	500	\$2.04
559F4	E84 1" CTS	B	50	500	\$3.90
559F5	E84 1-1/4" CTS	B	10	10	\$4.80
<b>559F6</b>	E84 1-1/2" CTS	B	10	10	\$4.80
559F7	E84 2" CTS	B	10	10	\$5.74

**EZ Glide™ Suspension Clamp**

**Suspension Clamp**



557-2



557-3Q

Item Number	Item Description	Pkg Type	Min Qty	Case Qty	Price
<b>STANDARD</b>					
557-2	1/2" CTS	B	100	1000	\$0.31
557-2PK2	1/2" CTS, 5/Bag	CI	10	10	\$2.30
557-3	3/4" CTS	B	100	1000	\$0.32
557-3PK2	3/4" CTS, 5/Bag	CI	10	10	\$2.35
557-4	1" CTS	B	50	500	\$0.71
557-4PK2	1" CTS, 5/Bag	CI	10	10	\$4.30
557-5	1-1/4" CTS	B	25	250	\$1.30
557-5PK2	1-1/4" CTS, 5/Bag	CI	10	10	\$7.25
557-6	1-1/2" CTS	B	25	250	\$1.45
557-6PK2	1-1/2" CTS, 5/Bag	CI	10	10	\$8.00
557-7	2" CTS	B	25	250	\$1.88
557-7PK2	2" CTS, 5/Bag	CI	10	10	\$10.15
<b>ACOUSTICAL</b>					
557-2Q	PipeDown™ 1/2" CTS Thru-Stud/Suspension Clamp, Contr Pack	B	50	50	\$2.99
557-3Q	PipeDown™ 3/4" CTS Thru-Stud/Suspension Clamp, Contr Pack	B	50	50	\$3.57
557-4Q	PipeDown™ 1" CTS Thru-Stud/Suspension Clamp, Contr Pack	B	25	25	\$7.23
557-5Q	PipeDown™ 1-1/4" CTS Thru-Stud/Suspension Clamp, Contr Pack	B	25	25	\$8.74

Supply

Drainage

Support

Specialties

Appendix

## EZ Glide™ Suspension Clamp (Cont)

### Suspension Clamp

Item Number	Item Description	Pkg Type	Min Qty	Case Qty	Price
<b>PLENUM-RATED</b>					
557F2	E84 1/2" CTS	B	100	1000	\$1.72
557F3	E84 3/4" CTS	B	50	500	\$2.04
557F4	E84 1" CTS	B	50	500	\$2.80
557F5	E84 1-1/4" CTS	B	10	10	\$3.90
557F6	E84 1-1/2" CTS	B	10	10	\$4.80
557F7	E84 2" CTS	B	10	10	\$5.74



C557F2

## EZ Glide™ Tube Insulator

Item Number	Item Description	Pkg Type	Min Qty	Case Qty	Price
558-2	1/2" CTS	B	50	500	\$0.48
558-2PK2	1/2" CTS, 5/Bag	Cl	10	10	\$3.15
558-3	3/4" CTS	B	50	500	\$0.49
558-3PK2	3/4" CTS, 5/Bag	Cl	10	10	\$3.20
558-4	1" CTS	B	25	250	\$0.51

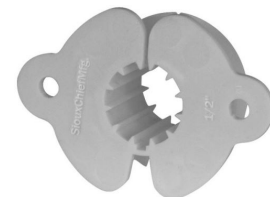

558-2

## Suspensulator™

### Tube Suspension Clamp & Insulator

Item Number	Item Description	Pkg Type	Min Qty	Case Qty	Price
558-E1	3/8" CTS	B	50	500	\$0.46
558-E2	1/2" CTS	B	50	500	\$0.36
558-E2PK2	1/2" CTS, 5/Bag	Cl	10	10	\$2.55
558-E3	3/4" CTS	B	50	500	\$0.37
558-E3PK2	3/4" CTS, 5/Bag	Cl	10	10	\$2.60
558-E4	1" CTS	B	25	250	\$0.49
558-E4PK2	1" CTS, 5/Bag	Cl	10	10	\$3.20



558-E3

## PipeEye™

### Metal Stud Insulator

· Fits 1-11/32" stud punch hole

Item Number	Item Description	Pkg Type	Min Qty	Case Qty	Price
<b>STANDARD</b>					
558-M23	1/2" - 3/4" CTS Black	B	100	1000	\$0.32
558-M23H	1/2" - 3/4" CTS Red, Contr Pack	B	100	1000	\$0.32
558-M23PK2	1/2" - 3/4" CTS Black, Contr Pack, 5/Bag	Cl	10	10	\$2.35
558-M4	1" CTS, Black	B	25	250	\$0.38
558-M4H	1" CTS, Red	B	50	1000	\$0.38



558-M23

**PipeEye™ (Cont)****Metal Stud Insulator**

558-M23R

Item Number	Item Description	Pkg Type	Min Qty	Case Qty	Price
<b>FLAME RETARDANT &amp; GLUEABLE</b>					
558-M23R	1/2" - 3/4" CTS White	B	100	1000	\$0.38
558-M4R	1" CTS White	B	25	250	\$0.43

**BiFolator™****Reversible Tube Insulator**

558-23

Item Number	Item Description	Pkg Type	Min Qty	Case Qty	Price
558-23	1/2" & 3/4" CTS, Flexible LDPE (Ivory)	B	100	1000	\$0.32
558-23B	1/2" & 3/4" CTS, Rigid HDPE (Black)	B	100	1000	\$0.32

**MainBlock™****1-1/2" Offset CTS Pipe Clamp**

525-33

Item Number	Item Description	Pkg Type	Min Qty	Case Qty	Price
525-32C	1/2" CTS w/ Screws, Contr Pack, 1/Bag	BI	1	25	\$6.38
525-33	3/4" CTS w/ Screws, 1/Bag	B	1	25	\$6.58
525-33C	3/4" CTS w/ Screws, Contr Pack, 1/Bag	BI	1	25	\$6.58
525-34	1" CTS w/ Screws, 1/Bag	B	1	25	\$6.75
525-34C	1" CTS w/ Screws, Contr Pack, 1/Bag	BI	1	25	\$6.75
525-35	1-1/4" CTS w/ Screws, 1/Bag	B	1	25	\$7.18
525-35C	1-1/4" CTS w/ Screws, 1/Bag	X	1	25	\$7.18

**TouchDown™**

**Universal Pipe Clamp**

· For 1/4" - 1" CTS and 1/8" - 1" Sch. 40 pipe

Item Number	Item Description	Pkg Type	Min Qty	Case Qty	Price
<b>STANDARD</b>					
550-11	1 Bridge, 1 Base, 1 Screw/Bag	B	100	100	\$0.82
550-11PK2	5 Bridges, 5 Bases, 5 Screws/Bag	Cl	1	10	\$4.85
550-12	Contractor Pack: 100 Bridges, 100 Bases, 100 Screws (Bulk)	B	1	1	\$61.34
<b>BEAM CLAMP</b>					
550-11E	1 Bridge, 1 Base w/ Attached Beam Clamp/Bag	Bl	100	100	\$4.28
<b>ACOUSTICAL CLAMP</b>					
550-11Q	PipeDown™ 1 Bridge, 1 Base, 1 Screw, 2 Inserts/Bag	B	100	100	\$1.92
550-11QPK2	PipeDown™ 10 Bridges, 10 Bases, 10 Screws, 20 Inserts/Bag	Cl	1	10	\$19.95
<b>PLENUM-RATED</b>					
550F11	E84 1 Bridge, 1 Base, 1 Screw/Bag	Bl	25	100	\$4.15



550-11



550-11E



550-11Q



550F11

**TD+™**

**Large Universal Pipe Clamp**

· One clamp fits 1/2" CTS tube thru 2" IPS (steel or plastic)

**Related Products**

TD+™ Commercial Overhead Hangers p 536

Item Number	Item Description	Pkg Type	Min Qty	Case Qty	Price
<b>STANDARD</b>					
550-2111	TD+ Clamp Base, Bridge And Screws, 1/Bag	Bl	50	50	\$3.57
550-2111PK3	50 Bases, 50 Bridges, 100 Screws (Contr Pack) Bulk	B	1	1	\$178.50
550-2112	TD+ Clamp Base, 2 Bridges And Screws	Bl	1	25	\$4.53



550-2112

Supply

Drainage

Support

Specialties

Appendix

**HangsTuff Jr.™**

Item Number	Item Description	Pkg Type	Min Qty	Case Qty	Price
553-22W	1/2" × 1/2" CTS	B	50	150	\$1.34
553-23W	1/2" × 3/4" CTS	B	50	150	\$1.49
553-2W	1/2" CTS	CI	50	50	\$0.90
553-33W	3/4" × 3/4" CTS	B	50	150	\$1.49
553-3W	3/4" CTS	CI	50	50	\$0.99
553-4W	1" CTS	CI	50	50	\$1.11
553-5W	1-1/4" CTS	CI	50	50	\$1.24



**Single Hole Tube Strap**

Item Number	Item Description	Pkg Type	Min Qty	Case Qty	Price
550-02	1/2" CTS, 100/Bag	BI	1	10	\$18.48

Supply

Drainage

Support

Specialties

Appendix

# **Metal CTS/IPS**

**Two-Hole Tube Strap**

**Vinyl-Coated Steel Clamp**

**Wire Pipe Hooks**

**Milford/Natick Hangers**







2-Hole Tube Strap

Item Number	Item Description	Pkg Type	Min Qty	Case Qty	Price
<b>COPPER</b>					
500-2	1/2" CTS w/ Nails	B	100	500	\$0.52
500-3	3/4" CTS w/ Nails	B	100	500	\$0.60
<b>COPPER-PLATED</b>					
501-0	1/4" CTS w/ Nails	B	100	500	\$0.19
501-1	3/8" CTS w/ Nails	B	100	500	\$0.20
501-2	1/2" CTS w/ Nails	B	100	500	\$0.21
501-2PK	1/2" CTS	CI	100	100	\$0.46
501-2PK2	1/2" CTS, 10/Bag	CI	10	10	\$2.87
501-2PK3	1/2" CTS, (Contr Pack), 100/Bag	BI	1	10	\$21.20
501-3	3/4" CTS w/ Nails	B	100	500	\$0.26
501-3PK	3/4" CTS	CI	100	100	\$0.51
501-3PK2	3/4" CTS, 10/Bag	CI	10	10	\$3.35
501-3PK3	3/4" CTS, (Contr Pack), 100/Bag	BI	1	10	\$26.00
501-4	1" CTS w/ Nails	B	100	100	\$0.36
501-4PK	1" CTS	CI	100	100	\$0.61
501-5	1-1/4" CTS w/ Nails	B	100	100	\$0.54
501-5PK	1-1/4" CTS	CI	100	100	\$0.79
501-6	1-1/2" CTS w/ Nails	B	100	100	\$0.59
501-6PK	1-1/2" CTS	CI	100	100	\$0.84
501-7	2" CTS w/ Nails	B	100	100	\$0.64
<b>GALVANIZED</b>					
502-1	3/8" IPS	B	100	100	\$0.22
502-2	1/2" IPS	B	100	100	\$0.25
502-2PK2	1/2" IPS, 10/Bag	CI	10	10	\$3.25
502-3	3/4" IPS	B	100	100	\$0.30
502-3PK2	3/4" IPS, 10/Bag	CI	10	10	\$3.75
502-4	1" IPS	B	100	100	\$0.45
502-4PK2	1" IPS, 4/Bag	CI	10	10	\$2.55
502-5	1-1/4" IPS	B	50	50	\$0.63
502-5PK2	1-1/4" IPS, 4/Bag	CI	10	10	\$3.27
502-6	1-1/2" IPS	B	50	50	\$0.68
502-6PK2	1-1/2" IPS, 4/Bag	CI	10	10	\$3.47
502-7	2" IPS	B	50	50	\$0.92
502-75	2-1/2" IPS	B	25	25	\$1.89
502-7PK	2" IPS	CI	50	50	\$1.16
502-7PK2	2" IPS, 4/Bag	CI	10	10	\$4.43
502-8	3" IPS	B	25	25	\$2.27
502-8PK	3" IPS	CI	15	15	\$2.52
502-9	4" IPS	B	25	25	\$2.73
502-9PK	4" IPS	CI	10	10	\$2.98



500-2



501-2



502-2

Supply

Drainage

Support

Specialties

Appendix



523-32

### Vinyl-coated Steel Clamp with Screw

- Not for use with CPVC pipe or fittings
- Complies with National Fuel Gas Code for supporting CSST

Item Number	Item Description	Pkg Type	Min Qty	Case Qty	Price
523-31	3/8" Nominal w/ Screw	B	100	1000	\$1.16
523-32	1/2" Nominal w/ Screw	B	100	1000	\$1.27
523-33	3/4" Nominal w/ Screw	B	50	500	\$1.33
523-34	1" Nominal w/ Screw	B	50	500	\$1.42



506-34



506-36C



506-34P

### Wire Pipe Hook

- Vinyl-coated models are not for use with CPVC pipe or fittings

Item Number	Item Description	Pkg Type	Min Qty	Case Qty	Price
<b>PLAIN STEEL</b>					
506-26	1/2" IPS × 6"	B	50	500	\$0.44
506-26PK2	1/2" IPS × 6" 5/Pack	CI	5	5	\$4.60
506-34	3/4" IPS × 4"	B	50	500	\$0.37
506-36	3/4" IPS × 6"	B	50	500	\$0.47
506-36PK2	3/4" IPS × 6" 5/Pack	CI	5	5	\$4.80
506-46	1" IPS × 6"	B	50	500	\$0.50
506-46PK2	1" IPS × 6" 5/Pack	CI	5	5	\$5.10
506-56	1-1/4" IPS × 6"	B	50	500	\$0.59
506-66	1-1/2" IPS × 6"	B	50	500	\$0.63
<b>COPPER-PLATED STEEL</b>					
506-26C	1/2" IPS × 6"	B	50	500	\$0.59
506-26CPK2	1/2" IPS × 6" 5/Pack	CI	5	5	\$3.70
506-36C	3/4" IPS × 6"	B	50	500	\$0.61
506-36CPK2	3/4" IPS × 6" 5/Pack	CI	5	5	\$3.80
506-46C	1" IPS × 6"	B	50	500	\$0.62
506-46CPK2	1" IPS × 6" 5/Pack	CI	5	5	\$3.85
<b>VINYL-COATED STEEL</b>					
506-26P	1/2" IPS × 6"	B	50	500	\$0.77
506-34P	3/4" IPS × 4"	B	50	500	\$0.66
506-36P	3/4" IPS × 6"	B	50	500	\$0.81
506-38P	3/4" IPS × 8"	B	50	500	\$0.83
506-46P	1" IPS × 6"	B	50	500	\$0.87

### Milford Hanger

#### Epoxy-Coated Steel



512-36PK

Item Number	Item Description	Pkg Type	Min Qty	Case Qty	Price
512-26PK	1/2" CTS × 6"	BI	50	50	\$2.59
512-36PK	3/4" CTS × 6"	BI	50	50	\$2.72
512-46PK	1" CTS × 6"	BI	50	50	\$2.93

**Natick Hanger**

**Epoxy-Coated Steel**

Item Number	Item Description	Pkg Type	Min Qty	Case Qty	Price
513-26PK	1/2" CTS × 6"	BI	25	25	\$3.47
513-36PK	3/4" CTS × 6"	BI	25	25	\$3.56



513-26PK

Supply

Drainage

Support

Specialties

Appendix



# **Anchors & Fasteners**

**Anchors, Screws & Fasteners**

**Thread Rod Anchors**

**StainlessStar™**

**Cable Ties**

**Stainless Steel  
Bands**





**Anchors, Screws and Fasteners**

Item Number	Item Description	Pkg Type	Min Qty	Case Qty	Price
<b>ANCHORS</b>					
590-10	Kit: 100 #10×1"X 5/16" Hex/Phillips Screws, 100 Plastic Anchors And One 1/4" Carbide Bit	Bl	1	10	\$14.36
<b>SCREWS</b>					
591-06B	#6 × 1" Yellow Zinc-Plated, Coarse-Thread Wood Screw, 100/Bag	Bl	1	10	\$3.56
591-081	#8 × 1" Zinc-Plated Drill-Tip Phillips Screw, 100/Bag	B	1	10	\$7.64



590-10



591-06B

**Sioux Chief Sammys - Thread Rod Anchors**

Accepts 3/8" Thread Rod

· UL & FM listed

Item Number	Item Description	Pkg Type	Min Qty	Case Qty	Price
<b>WOOD APPLICATIONS</b>					
590-4411	1/4" × 2" Screw, Vertical, 25/Box	Bl	1	5	\$45.48
590-4411-3	1/4" × 3" Screw, Vertical, 25/Box	Bl	1	5	\$47.14
590-4421	1/4" × 2" Screw, Horizontal, 25/Box	Bl	1	5	\$56.29
<b>CONCRETE APPLICATIONS</b>					
590-4412	1/4" × 1-3/4" Screw, Vertical, 25/Box	Bl	1	5	\$52.51
<b>STEEL BEAM APPLICATIONS</b>					
590-4413	1/4" × 1-1/4" Screw, Vertical, 25/Box	Bl	1	5	\$46.30
590-4423	1/4" × 1-1/4" Screw, Horizontal, w/ Nut, 25/Box	Bl	1	5	\$68.23
<b>INSTALLATION TOOLS</b>					
590-44ND1	Nut Driver #14 For Vertical Anchors (Black), 1/Bag	Bl	1	12	\$24.25
590-44ND2	Nut Driver #14SW For Horizontal Anchors (Red), 1/Bag	Bl	1	12	\$24.25



590-4411



590-4412



590-4413

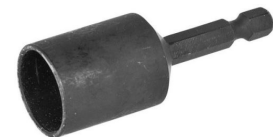

590-44ND1

Supply

Drainage

Support

Specialties

Appendix

## StainlessStar™

## Tube Locking One-Way Push Nut



612-2S

- 430 stainless steel
- For copper tube only

Item Number	Item Description	Pkg Type	Min Qty	Case Qty	Price
612-2S	1/2" Copper Tube	B	50	500	\$2.04
612-2SPK2	1/2" Copper Tube, 5/Bag	BI	10	10	\$10.50
612-3S	3/4" Copper Tube	B	25	250	\$2.14
612-3SPK2	3/4" Copper Tube, 5/Bag	BI	10	10	\$11.00
612-4S	1" Copper Tube	B	25	250	\$2.49

## Cable Ties

## Durable Non-Corrosive Nylon



554-08



554-608

Item Number	Item Description	Pkg Type	Min Qty	Case Qty	Price
<b>STANDARD</b>					
554-08	8" × 3/16"	B	100	2500	\$0.09
554-14	14-1/2" × 3/16"	B	100	1000	\$0.24
554-14H	14-1/2" × 5/16"	B	100	1000	\$0.47
554-21	21" × 5/16"	B	50	500	\$0.74
554-36	36" × 5/16"	B	50	250	\$1.01
<b>MOUNTING (USE #10 SCREW OR NAIL)</b>					
554-608	8" × 3/16"	B	500	500	\$0.30
554-614	14" × 3/16"	B	100	1000	\$0.44

## Stainless Steel Bands



574-72

- Band sizes refer to maximum diameter

Item Number	Item Description	Pkg Type	Min Qty	Case Qty	Price
574-710	10" Diameter Snap-Lock Stainless Steel Band	B	10	10	\$7.29
574-713	13" Diameter Snap-Lock Stainless Steel Band	B	10	10	\$9.84
574-72	5" Diameter Standard Stainless Steel Band	B	50	50	\$3.01
574-74	4" Diameter Snap-Lock Stainless Steel Band	B	50	50	\$3.78
574-75	5" Diameter Snap-Lock Stainless Steel Band	B	50	50	\$4.70
574-77	7" Diameter Snap-Lock Stainless Steel Band	B	50	50	\$5.36



# **DWV Hangers**

**Extension Hangers**

**Hanger Straps**

**Ground Stakes**

# DWV Hangers

## Extension Hangers

Strong, rigid extension hangers for DWV pipe. Made from corrosion and impact resistant polymers, or coated steel, hangers are designed to make properly supporting DWV lines faster and easier. Select items designed in accordance with IAPMO PS 95-2018e3 Standard for Pipe Support Hangers and Hooks.

## Hanger Straps

Hanger strap is available in plastic and metal, as well as our innovative ApeTape™ woven poly fabric strap. ApeTape™ is strong, highly flexible, and corrosion proof. Available in 10, 25, 50 or 100-ft rolls for any job size. Select items designed in accordance with IAPMO PS 95-2018e3 Standard for Pipe Support Hangers and Hooks.

## Ground Stakes

Ground stakes to prevent on-grade DWV pipes from moving, shifting or floating during concrete pours. Available with a plastic head, or an all-steel version.

# Extension Hangers

**HangsTuff™**

**Swivel J-Hanger™**

**Gas Vent Pipe Support**

**ZipStick™**

**Metal DWV**

**StickEm Up™**



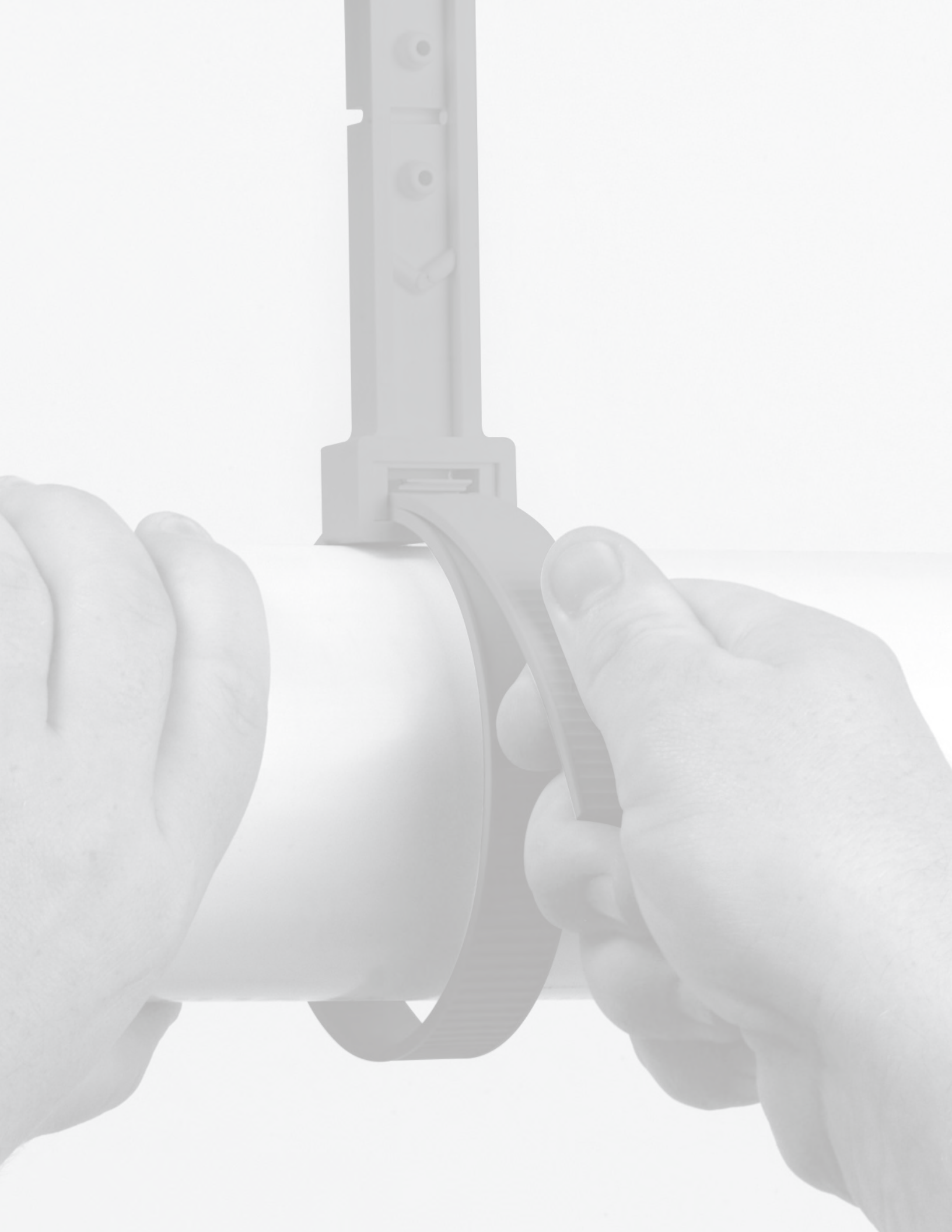

**HangsTuff™**

**DWV Pipe Hanger**

Item Number	Item Description	Pkg Type	Min Qty	Case Qty	Price
<b>WHITE</b>					
553-6W	1-1/2" Sch. 40, w/ Pre-Loaded Nails	BI	50	50	\$1.11
553-6WM25	1-1/2" Sch. 40, Megapac: 25 Hooks And 50 Bulk Nails Per Bag	BI	10	10	\$25.97
553-7W	2" Sch. 40, w/ Pre-Loaded Nails	BI	50	50	\$1.16
553-7WM25	2" Sch. 40, Megapac: 25 Hooks And 50 Bulk Nails Per Bag	BI	10	10	\$27.53
553-830W	3" Sch. 30, w/ Pre-Loaded Nails	BI	50	50	\$1.47
553-8W	3" Sch. 40 w/ Pre-Loaded Nails	BI	50	50	\$1.32
553-8WM25	3" Sch. 40 Megapac: 25 Hooks And 50 Bulk Nails Per Bag	BI	10	10	\$31.27
553-9W	4" Sch. 40, w/ Pre-Loaded Nails	BI	25	25	\$1.49
<b>ACCESSORIES</b>					
521-210	3/8" ATR Extension Stainless Steel L-Bracket w/ Screws	BI	25	25	\$2.04



**Swivel J-Hanger™**

**DWV Hanger**

Item Number	Item Description	Pkg Type	Min Qty	Case Qty	Price
553-6WZ	1-1/2" Sch 40, Nails Included	B	25	100	\$1.68
553-6WZPK2	1-1/2" Sch 40, Nails Included, 4/Bag	BI	1	5	\$7.47
553-7WZ	2" Sch 40, Nails Included	B	25	100	\$1.75
553-7WZPK2	2" Sch 40, Nails Included, 4/Bag	BI	1	5	\$7.75
553-8WZ	3" Sch 40, Nails Included	B	25	100	\$2.13
553-8WZPK2	3" Sch 40, Nails Included, 4/Bag	BI	1	5	\$9.27
553-9WZ	4" Sch 40, Nails Included	B	25	100	\$2.27
553-9WZPK2	4" Sch 40, Nails Included, 4/Bag	BI	1	5	\$9.83



**Gas Vent Pipe Support**

**Type B Pipe Support**

• Pivoting foot with 1½" or 3" offset

Item Number	Item Description	Pkg Type	Min Qty	Case Qty	Price
549-808	3" Metal Vent Support	B	6	6	\$8.55
549-809	4" Metal Vent Support	B	6	6	\$9.08
549-810	5" Metal Vent Support	B	6	6	\$10.10
549-811	6" Metal Vent Support	B	6	6	\$11.19



549-808



553-014

### ZipStick™ Universal Pipe Hanger

Item Number	Item Description	Pkg Type	Min Qty	Case Qty	Price
<b>GRAY</b>					
553-014	14"	B	100	100	\$3.47
553-014PK	14"	BI	25	25	\$3.72
553-026	26"	B	50	50	\$5.41
553-STRP	Strap Only	B	50	50	\$1.82
<b>L-BRACKET ACCESSORY</b>					
521-210	3/8" ATR Extension Stainless Steel L-Bracket w/ Screws	BI	25	25	\$2.04



521-210

### Metal DWV Hanger

· Vinyl-coated models are not for use with CPVC pipe or fittings

Item Number	Item Description	Pkg Type	Min Qty	Case Qty	Price
<b>GALVANIZED</b>					
510-6PK	1-1/2" Sch 40	CI	20	20	\$3.22
510-7PK	2" Sch 40	CI	20	20	\$3.44
510-8PK	3" Sch 40	CI	20	20	\$5.24
510-9PK	4" Sch 40	CI	20	20	\$5.67
<b>VINYL-COATED GALVANIZED STEEL</b>					
510-6VPK	1-1/2" Sch 40	CI	10	10	\$5.77
510-7VPK	2" Sch 40	CI	10	10	\$7.55
510-8VPK	3" Sch 40	CI	10	10	\$8.51
510-9VPK	4" Sch 40	CI	10	10	\$10.06



510-7PK



510-6VPK



549-712

### StickEm Up™ Dual-Sized DWV Stanchion Pipe Support

· Ideal for PVC vent piping

Item Number	Item Description	Pkg Type	Min Qty	Case Qty	Price
549-712	1-1/2"- 2" Sch 40	B	50	50	\$2.53
549-734	3"- 4" Sch 40	B	25	25	\$2.61

# Hanger Straps

ApeTape™

Plastic

Metal



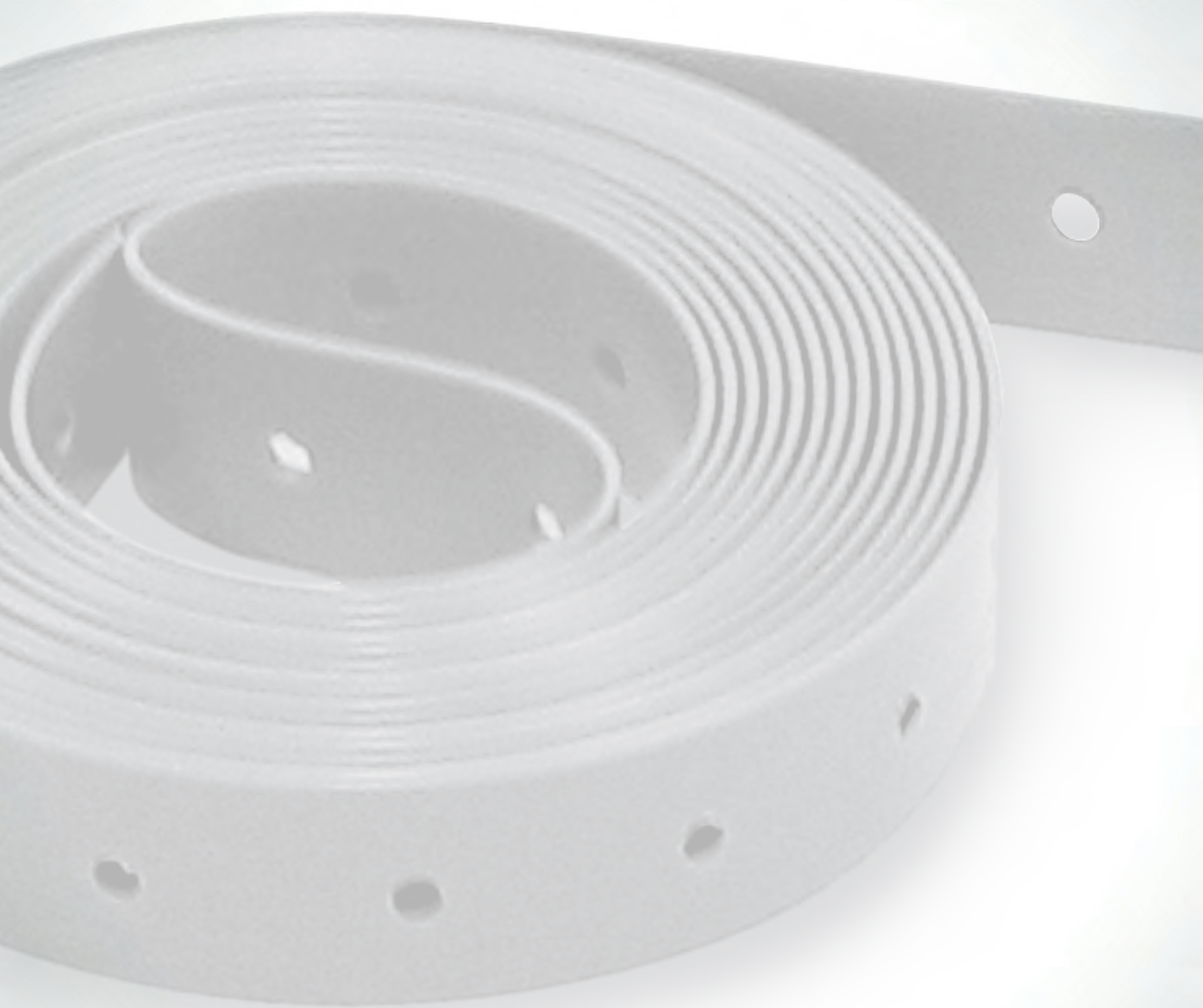



**ApeTape™**

**Woven Polypropylene Hanger Strap**

Item Number	Item Description	Pkg Type	Min Qty	Case Qty	Price
554-100W	5/8" × 100', 1/Bag	BI	1	20	\$16.24
554-25W	5/8" × 25', 1/Bag	BI	1	20	\$4.65



554-100W

**Plastic Hanger Strap**

**Polypropylene with 1/8" Holes**

- Not recommended for use below 32°F
- Maximum load rating: 20-lbs.

Item Number	Item Description	Pkg Type	Min Qty	Case Qty	Price
554-100	3/4" × 100', 1/Bag	BI	1	20	\$17.13
554-10PK2	3/4" × 10', 1/Bag	CI	10	10	\$3.02
554-25	3/4" × 25', 1/Bag	BI	1	20	\$5.03



554-100

**Metal Hanger Strap**

- Wear gloves and eye protection

Item Number	Item Description	Pkg Type	Min Qty	Case Qty	Price
<b>GALVANIZED STEEL WITH ALTERNATING 1/4" AND 3/16" HOLES</b>					
524-10	3/4" × 10' Coil, 24-Ga	B	50	50	\$3.02
524-100	3/4" × 100' Coil 24-Ga, 1/Box	B	5	5	\$28.50
524-1022PK2	3/4" × 10' Coil 22-Ga, 1/Bag	CI	10	50	\$4.12
524-10PK	3/4" × 10' Coil 24-Ga IBC	BI	50	50	\$3.27
524-10PK2	3/4" × 10' Coil 24-Ga, 1/Bag	CI	10	10	\$3.52
524-50	3/4" × 50' Coil 24-Ga, 1/Box	B	10	10	\$14.27
524-50PK3	3/4" × 50' Coil 24-Ga, (Contr Pack), 1/Box	BI	1	10	\$14.27
528-10	3/4" × 10' Coil, 28-Ga	B	50	50	\$2.95
528-100	3/4" × 100' Coil, 28-Ga, 1/Box	B	5	5	\$27.13
528-10PK	3/4" × 10' Coil, 28-Ga IBC	BI	50	50	\$3.20
528-10PK2	3/4" × 10' Coil, 28-Ga, 1/Bag	CI	10	10	\$3.45
528-25PK2	3/4" × 25' Coil, 28-Ga, 1/Bag	CI	1	12	\$6.83
528-50	3/4" × 50' Coil, 28-Ga, 1/Box	B	10	10	\$13.57
<b>COPPER-PLATED STEEL WITH ALTERNATING 1/4" AND 3/16" HOLES</b>					
524-10CPK2	3/4" × 10' Coil, 24-Ga, 1/Bag	CI	10	10	\$9.64



524-10



524-10CPK2



# Ground Stakes

Tomahawk™

Simple and effective - the Tomahawk™ keeps ground-rough DWV pipe securely in place before and during the concrete pour.





**Tomahawk™**

**DWV Ground Stake**

Item Number	Item Description	Pkg Type	Min Qty	Case Qty	Price
<b>POLYETHYLENE HEAD</b>					
535-914	3/8" × 14" Rebar w/ Poly Head	B	25	25	\$4.21
535-926	3/8" × 26" Rebar w/ Poly Head	B	25	25	\$5.74
535-9P	Poly Head Only (Fits #3 Rebar)	B	50	50	\$0.98
<b>ALL STEEL</b>					
535-14	3/8" × 14" All Steel	B	25	25	\$5.30



Supply

Drainage

Support

Specialties

Appendix



# **Brackets**

**Stub Out Brackets**

**Bend Supports**

**Universal Brackets**

**Adjustable/Multi-Purpose  
Brackets**

**Commercial Brackets**

**Overhead Brackets**

**Manifold Brackets**

**Stud Guards & Safety Plates**

**Water Heater Accessories**

# Brackets

## Stub Out Brackets

Sioux Chief offers a multitude of easy-to-install stub out brackets, which offer a cost-effective solution to time spent on the job site finding/measuring/cutting blocks of wood.

## Bend Supports

Plastic and metal bend supports available for use with 1/2" and 3/4" PEX tube. Bend supports help prevent kinks in PEX tube and allow tighter-radius bends without using elbow fittings.

## Universal Brackets

Sioux Chief's PowerBar™ system adjusts 'telescopically' to accommodate almost any stud or joist opening. Acoustical models reduce the transfer of waterline noise to the building members.

## Adjustable/Multi-Purpose Brackets

Cost-effective galvanized or copper-plated flat and adjustable brackets available for a variety of applications.

## Commercial Brackets

Brackets designed to meet the demands of commercial projects. Mini Strut options offer an alternative to standard strut products. Unique clamps and other accessories available, including the TD+™ system.

## Overhead Brackets

Simple, galvanized and copper-plated clamps for hanging and supporting pipe/tube overhead. Threaded rod, anchors, and other accessories available.

## Manifold Brackets

Wall-mounted bracket with integral offset for securing dual manifolds having connecting tubes on the same side.

## Stud Guards & Safety Plates

Guards and plates offer code-required protection of plumbing lines inside walls or support for notched studs.

## Water Heater Accessories

Easy-to-assemble, galvanized water heater stands keep appliances off the floor, and convenient support kits hold expansion tanks securely in place where needed.



# Stub Out Brackets

**StrongArm™**

**Edge™ Bracket**

**SecureAll™**

**Stub Out Brackets**

**Stub Out Brackets  
with Stud Guard**

**Solder Straps**

Sioux Chief's popular StrongArm™ bracket bends to mount in standard, narrow, or oddly-shaped stud cavities, while the unique LockBlock™ device keeps any copper, PEX, or CPVC stub out *rock* solid.

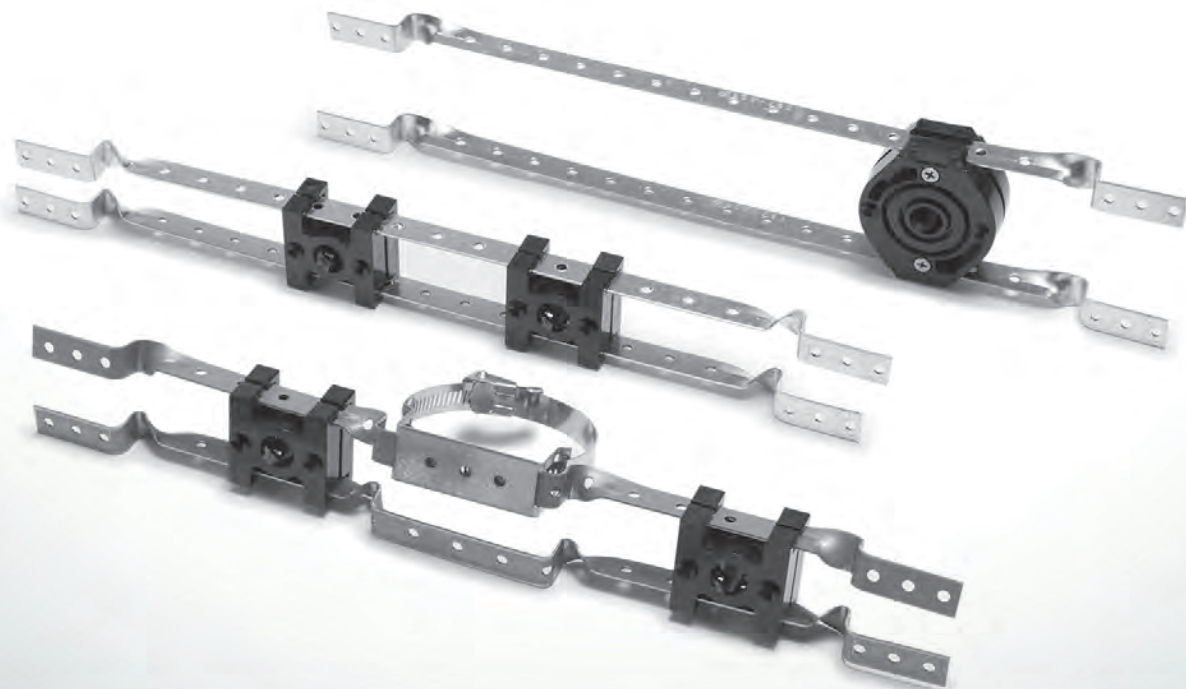



**525-1612**  
Page 515



**525-P2M1**  
Page 515



**525-B2**  
Page 516



**525-16WLB**  
Page 516



**525-WLB**  
Page 516



**525-162PBV**  
Page 516



**520-EC2**  
Page 517



**521-851**  
Page 517



**521-118**  
Page 517



**521-3725B**  
Page 517



**521-6416**  
Page 518

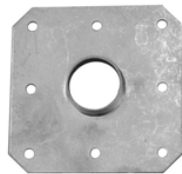

**505-24**  
Page 518



**550-MP2**  
Page 521



**550-PC2**  
Page 521



**550-FP2**  
Page 521



**523-2414**  
Page 525



**522-5501**  
Page 526



**523-712W**  
Page 526



**520-616**  
Page 529

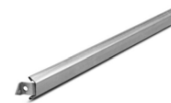

**520-19**  
Page 529



**525-02**  
Page 529



**525-6920**  
Page 529



**525-20B**  
Page 516

**StrongArm™**

**LockBlock™ or PEX Bend LockBlock™**

Item Number	Item Description	Pkg Type	Min Qty	Case Qty	Price
<b>BRACKET ASSEMBLIES FOR 16" STUD BAYS</b>					
525-1612	Twisted Brackets w/ One 1/2" Lockblock™	B	25	25	\$5.46
525-1613	Twisted Brackets w/ One 3/4" Lockblock™	B	25	25	\$5.85
525-1614	Twisted Brackets w/ One 1" Lockblock™	B	25	25	\$5.99
525-161PB	Twisted Brackets w/ One 1/2" PEX Bend Lockblock™	BI	25	25	\$7.47
525-161PBL	L-Bent Brackets w/ One 1/2" PEX Bend Lockblock™	B	25	25	\$7.47
525-161PBPk	Twisted Brackets w/ One 1/2" PEX Bend Lockblock™	CI	10	10	\$10.22
525-1622	Twisted Brackets w/ Two 1/2" Lockblock™	B	25	25	\$6.80
525-1622L	L-Bent Brackets w/ Two 1/2" Lockblock™	B	25	25	\$6.80
525-1622PK1	Twisted Brackets w/ Two 1/2" Lockblock™	CI	10	10	\$9.55
525-1623	Twisted Brackets w/ Two 3/4" Lockblock™	B	25	25	\$8.17
525-1624	Twisted Brackets w/ Two 1" Lockblock™	B	25	25	\$8.47
525-162PB	Twisted Brackets w/ Two 1/2" PEX Bend Lockblocks	BI	25	25	\$8.95
525-162PBL	L-Bent Brackets w/ Two 1/2" PEX Bend Lockblocks	B	25	25	\$8.95
525-162PBPk	Twisted Brackets Assembly w/ Two 1/2" PEX Bend Lockblock™	CI	10	10	\$11.70
<b>BRACKET ASSEMBLIES FOR 24" STUD BAYS</b>					
525-2412	Twisted Brackets w/ One 1/2" Lockblock™	B	25	25	\$6.21
525-2413	Twisted Brackets w/ One 3/4" Lockblock™	B	25	25	\$6.45
525-241PB	Twisted Brackets w/ One 1/2" PEX Bend Lockblock™	B	25	25	\$8.36
525-241PBL	L-Bent Brackets w/ One 1/2" PEX Bend Lockblock™	B	25	25	\$8.36
525-2422	Twisted Brackets w/ Two 1/2" Lockblock™	B	25	25	\$7.54
525-242PB	Twisted Brackets w/ Two 1/2" PEX Bend Lockblock™	B	25	25	\$9.79
525-242PBL	L-Bent Brackets w/ Two 1/2" PEX Bend Lockblock™	B	25	25	\$9.63
<b>KITS</b>					
525-B2M1	Bagged Kit: One 1/2" Lockblock™ w/ Galvanized Face Plate	BI	25	25	\$4.19
525-B2S	Bagged Kit: One 1/2" Lockblock™ w/ Two 2-1/2" Drill-Tip Screws	BI	1	50	\$2.75
525-B3S	Bagged Kit: One 3/4" Lockblock™ w/ Two 2-1/2" Drill-Tip Screws	BI	1	50	\$3.24
525-P2M1	Bagged Kit: One 1/2" PEX Bend Lockblock™ w/ Galvanized Face Plate	BI	25	25	\$4.79

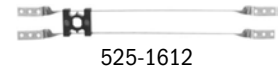

525-1612



525-241PBL



525-P2M1

Supply

Drainage

Support

Specialties

Appendix



525-B2

### StrongArm™ (Cont)

#### LockBlock™ or PEX Bend LockBlock™

Item Number	Item Description	Pkg Type	Min Qty	Case Qty	Price
<b>ACCESSORIES AND BULK COMPONENTS</b>					
525-16T	Twisted Bracket For 16" Stud Bays	B	100	100	\$1.71
525-20B	L-Bent Bracket For 16" Stud Bays	B	100	100	\$1.63
525-24T	Twisted Bracket For 24" Stud Bays	B	100	100	\$1.91
525-27B	L-Bent Bracket For 24" Stud Bays	B	100	100	\$1.93
525-B2	1/2" Lockblock™ w/ Screws	B	50	50	\$1.76
525-B3	3/4" Lockblock™ w/ Screws	B	50	50	\$1.98
525-B4	1" Lockblock™ w/ Screws	B	50	50	\$2.19
525-P2	1/2" PEX Bend Only	B	50	50	\$1.63
525-P22	1/2" PEX Bend Lockblock™ (3-Piece Assembly)	B	50	50	\$2.57
525-P2M	Lockblock™ Face Plate	B	25	100	\$2.19
525-P2PK	1/2" PEX Bend Only	CI	10	10	\$1.88
591-06B	#6 × 1" Yellow Zinc-Plated, Coarse-Thread Wood Screw, 100/Bag	BI	1	10	\$3.56
591-081	#8 × 1" Zinc-Plated Drill-Tip Phillips Screw, 100/Bag	B	1	10	\$7.64



525-16WLB



525-WLB

### StrongArm™

#### Shower WallNut™ LockBlock™

Related Products  
Shower WallNut™ p 640

Item Number	Item Description	Pkg Type	Min Qty	Case Qty	Price
525-16WLB	Twisted Brackets w/ One Shower WallNut™ Lockblock™ For 1/2" Copper Ell	B	25	25	\$6.92
<b>BULK COMPONENTS</b>					
525-WLB	1/2" Shower WallNut™ Lockblock™	B	50	50	\$2.54



525-1622V



525-162PBV

### StrongArm™

#### Vent Support

Item Number	Item Description	Pkg Type	Min Qty	Case Qty	Price
<b>WITH LOCKBLOCK™</b>					
525-1622V	Vent Pipe Assembly: SaddleUp™ Clamp, S/S Band & Two 1/2" Lockblock™	B	25	25	\$11.80
<b>WITH PEX BEND LOCKBLOCK™</b>					
525-162PBV	Vent Pipe Assembly: SaddleUp™ Clamp, S/S Band & Two 1/2" PEX Bend Lockblock™	B	25	25	\$13.95

**Edge™ Support System**

**Copper-Plated and Galvanized Angle Brackets**

Item Number	Item Description	Pkg Type	Min Qty	Case Qty	Price
<b>COMPONENTS</b>					
520-E16	Galvanized Bracket For 16" Stud Bays	B	100	100	\$1.63
520-E24	Galvanized Bracket For 24" Stud Bays	B	100	100	\$2.67
520-EC2	1/2" CTS Edge Clamp	B	100	1000	\$0.55
520-EC3	3/4" CTS Edge Clamp	B	100	1000	\$0.59

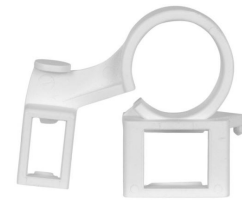

520-EC2

**Secure-All™**

**Copper-Plated Stub Out Bracket**

Item Number	Item Description	Pkg Type	Min Qty	Case Qty	Price
521-851	2" x 20" 18-Ga. For 1/2", 3/4" And 1" Copper, Extruded Holes	B	50	50	\$6.36
521-851PK	2" x 20" 18-Ga. For 1/2", 3/4" And 1" Copper, Extruded Holes	Cl	25	25	\$6.86
521-852	2-3/8" x 26" 18-Ga. For 1/2", 3/4" And 1" Copper, Extruded Holes	B	50	50	\$7.76



521-851

**Stub Out Bracket**

· Heat the tube, not the bracket

**Related Products**

PipeEye™ Insulators p 483

Item Number	Item Description	Pkg Type	Min Qty	Case Qty	Price
<b>COPPER-PLATED</b>					
521-118	1-1/4" x 20" 16-Ga. For 1/2" Copper	B	50	50	\$5.81
521-118R	1-1/4" x 20" 16-Ga. For 1/2" Copper w/ Extruded Holes	B	25	25	\$6.14
521-126	1-1/4" x 26" 16-Ga. For 1/2" Copper	B	50	50	\$8.75
521-810	1-3/4" x 20" 16-Ga. For 1/2", 3/4" And 1" Copper	B	50	50	\$6.91
521-810PK	1-3/4" x 20" 16-Ga. For 1/2", 3/4" And 1" Copper	Cl	50	50	\$7.41
521-820	1-3/4" x 20" 24-Ga. For 1/2", 3/4" And 1" Copper w/ Extruded Holes	B	50	50	\$6.52
<b>GALVANIZED - FOR USE WITH PIPEEYE™ INSULATORS</b>					
521-318	2" x 20" 14-Ga.	B	50	50	\$4.84
521-360	2" x 26" 14-Ga.	B	50	50	\$5.87
521-3725B	3" x 4-3/4" L-Bracket, 14-Ga.	B	100	100	\$2.14



521-118



521-3725B

Supply

Drainage

Support

Specialties

Appendix



521-6416

### Stub Out Bracket with Stud Guard

#### Copper-Plated

Item Number	Item Description	Pkg Type	Min Qty	Case Qty	Price
521-6415	1/2" Or 3/4" Copper, Extruded Holes & Nail Spikes, 16-Ga	B	25	25	\$4.63
521-6416	1/2" Or 3/4" Copper, Extruded Holes & Pre-Drilled Holes, 16-Ga.	B	25	25	\$4.63

### Solder Straps

#### Copper-eared Tube Hanger

Item Number	Item Description	Pkg Type	Min Qty	Case Qty	Price
<b>SQUARE O™ STRAP</b>					
505-24	1/2" Copper	B	100	100	\$0.80
505-34	3/4" Copper	B	100	100	\$0.85
505-44	1" Copper	B	50	50	\$0.99
<b>SOLDER O™ STRAP</b>					
505-29	1/2" Copper	B	100	100	\$0.98
505-39	3/4" Copper	B	100	100	\$1.07
505-49	1" Copper	B	50	50	\$1.27
<b>SOLDER C™ STRAP</b>					
505-5	1-1/4" Copper	B	25	100	\$1.51



505-24



505-39



505-5

# Bend Supports

**SideWinder™**

**Simple Bend Support**

**PEXChair™**

**PEX Sleeve**

**PEX Bend Support**







**SideWinder™**

**Related Products**

StrongArm™ w/ PEX Bend LockBlock™ p 515

Item Number	Item Description	Pkg Type	Min Qty	Case Qty	Price
<b>METAL BEND SUPPORTS</b>					
550-M2	Metal 1/2" PEX Bend Support	B	50	50	\$1.61
550-M2PK	Metal 1/2" PEX Bend Support	Cl	10	10	\$2.36
550-M3	Metal 3/4" PEX Bend Support	B	25	25	\$2.75
550-M3PK	Metal 3/4" PEX Bend Support	Cl	10	10	\$3.50
550-MP2	Metal 1/2" PEX Bend Support w/ Plate	B	25	25	\$5.34
550-MP2PK	Metal 1/2" PEX Bend Support w/ Plate	Cl	10	10	\$6.09
550-MP3	Metal 3/4" PEX Bend Support w/ Plate	B	25	25	\$6.14



550-MP2

**Simple Bend Support**

Item Number	Item Description	Pkg Type	Min Qty	Case Qty	Price
550-PB2	Plastic 1/2" PEX Bend Support	B	50	50	\$1.33
550-PB3	Plastic 3/4" PEX Bend Support	B	50	50	\$3.59



550-PB2

**PexChair™**

Item Number	Item Description	Pkg Type	Min Qty	Case Qty	Price
550-PC2	1/2" PEXchair™ Slab Organizer	B	10	10	\$14.13



550-PC2

**Through-Floor Protective Sleeve**

· Protects tube through sub-floor going directly to fixture

Item Number	Item Description	Pkg Type	Min Qty	Case Qty	Price
550-FP2	1/2" CTS Protective Floor Sleeve	B	25	25	\$6.12
550-FP2S	1/2" CTS Protective Floor Sleeve (Short)	B	25	25	\$5.67



550-FP2

Supply

Drainage

Support

Specialties

Appendix



# Universal Brackets

**PowerBar™**

Sioux Chief's PowerBar™ is designed for ultimate versatility with preloaded, multi-size TouchDown™ clamps. Adjustable and fixed-length brackets with a full line of accessories make it perfect for nearly any application.

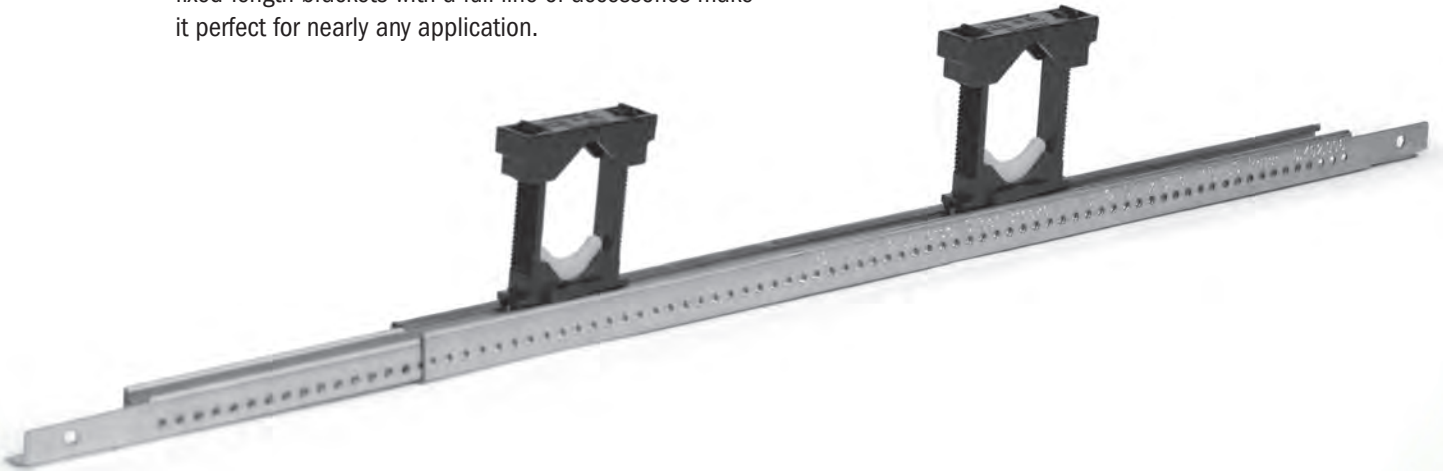



UNIVERSAL SLIDE  
PEND  
SOUX CHIEF MFG.

UNIVERSAL SLIDE  
SOUX CHIEF MFG.

**PowerBar™**

**Universal Slider Bracket**

· Clamps 1/4" - 1" CTS tube & 1/8" - 1" Sch. 40 pipe

Item Number	Item Description	Pkg Type	Min Qty	Case Qty	Price
<b>9" - 16" ADJUSTABILITY</b>					
523-16	Bracket Only	B	50	50	\$4.18
523-1604	1 Bracket, 6 Drill-Tip Screws	B	50	50	\$4.67
523-1610	1 Bracket, 1 TouchDown Clamp	B	50	50	\$5.21
523-1614	1 Bracket, 1 TouchDown Clamp w/ Screws	B	50	50	\$5.70
523-1620	1 Bracket, 2 TouchDown Clamps	B	50	50	\$5.86
523-1620PK1	1 Bracket, 2 TouchDown Clamps	Cl	10	10	\$8.61
523-1624	1 Bracket, 2 TouchDown Clamps w/ Screws	B	50	50	\$6.33
523-1630	1 Bracket, 3 TouchDown Clamps	B	50	50	\$6.87
523-1634	1 Bracket, 3 TouchDown Clamps w/ Screws	B	50	50	\$7.43
<b>14" - 26" ADJUSTABILITY</b>					
523-24	Bracket Only	B	50	50	\$5.42
523-2404	1 Bracket, 6 Drill-Tip Screws	B	50	50	\$5.93
523-2414	1 Bracket, 1 TouchDown Clamp w/ Screws	B	50	50	\$6.98
523-2420	1 Bracket, 2 TouchDown Clamps	B	50	50	\$7.07
523-2424	1 Bracket, 2 TouchDown Clamps w/ Screws	B	50	50	\$7.66
523-2434	1 Bracket, 3 TouchDown Clamps w/ Screws	B	50	50	\$8.76
523F2424	Plenum-Rated Assembly: 1 Bracket, Two E84 Clamps w/ Screws	B	50	50	\$9.92
<b>KITS AND CONTRACTOR PACKS</b>					
523-162001	9"-16" Contr Pack 50 Brackets w/2 Clamps And 100 Bridges (Bulk) (No Screws)	B	1	1	\$284.77
523-162401	9"-16" Contr Pack 50 Brackets w/2 Clamps, 100 Bridges And 200 Screws (Bulk)	B	1	1	\$295.33
523-1K52000	Lav/Vent Assembly: 1 Bracket, 2 Clamps, 1 SaddleUp™ Clamp And S/S Band	B	10	10	\$9.53
523-242001	14"-24" Contr Pack 50 Brackets w/2 Clamps And 100 Bridges (Bulk) (No Screws)	B	1	1	\$347.43
523-242401	14"-24" Contr Pack 50 Brackets w/2 Clamps, 100 Bridges And 200 Screws (Bulk)	B	1	1	\$357.89
523-VLK1	Vent Loop Kit Assembly w/ 1 Clamp And 2 ComboSaddles	Bl	25	25	\$10.94
523-VLK2	Vent Loop Kit Assembly w/ 2 Clamps And 2 ComboSaddles	Bl	25	25	\$11.44

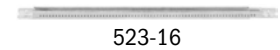

523-16

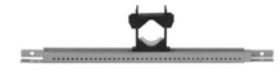

523-2414



523-VLK2

Supply

Drainage

Support

Specialties

Appendix

Supply

Drainage

Support

Specialties

Appendix



522-100B



523-1634Q

**PowerBar™**

**Acoustical**

Item Number	Item Description	Pkg Type	Min Qty	Case Qty	Price
522-100B	PipeDown™, 100 Inserts/Bag (Not For Use w/ Plenum-Rated Models)	B	1	10	\$46.57
522-100BPK2	PipeDown™, 10 Inserts/Bag (Not For Use w/ Plenum-Rated Models)	BI	1	10	\$5.16
523-1614Q	PipeDown™ Assembly: 1 Bracket, 1 Clamp w/ Cushions & Screws	B	25	25	\$6.96
523-1624Q	PipeDown™ Assembly: 1 Bracket, 2 Clamps w/ Cushions & Screws	B	25	25	\$7.38
523-1634Q	PipeDown™ Assembly: 1 Bracket, 3 Clamps w/ Cushions & Screws	B	25	25	\$9.15
523-16DEQ	PipeDown™ Assembly: 1 Bracket w/ 2 DE-90 Cushions	B	25	25	\$13.29
523-2424Q	PipeDown™ Assembly: 1 Bracket, 2 Clamps w/ Cushions & Screws	B	25	25	\$8.61
523-2434Q	PipeDown™ Assembly: 1 Bracket, 3 Clamps w/ Cushions & Screws	B	25	25	\$9.61
523-5500Q	PipeDown™ Acoustical TouchDown™ Clamp (Bulk)	B	100	100	\$1.39
523-5501Q	PipeDown™ Acoustical TouchDown™ Clamp (1 Set/Bag)	B	100	100	\$1.85
523-DEQ	PipeDown™ DE-90 Cushion (Bagged Set), 1 Pair/Bag	BI	1	25	\$8.40
523-DEQ50	PipeDown™ DE-90 Cushion Kit (Contr Pack), 50/Bag	B	1	4	\$27.41

**PowerBar™**

**Accessories and Bulk Components**

Item Number	Item Description	Pkg Type	Min Qty	Case Qty	Price
522-101	100 Bridges Only	B	100	100	\$0.25
522-102	100 Base Inserts Only	B	100	100	\$0.41
522-5500	100 Bases, 100 Bridges, 100 Base Inserts (Bulk)	B	100	100	\$0.64
522-5501	1 Bridge, 1 Clamp Base, 1 Base Insert (1 Set/Bag)	B	100	100	\$1.10
523-01	Ratchet-Locking ZipStrap™ w/ PowerBar Foot Adapter And Screw	B	10	50	\$2.69
523-1	SaddleUp™ Galvanized DWV Clamp	B	50	50	\$1.55
523-712W	ComboSaddle Fits 1-1/2" - 2" DWV	B	10	50	\$1.46
523-734W	ComboSaddle Fits 3"- 4" DWV	B	10	50	\$1.59
523F5500	Plenumsafe™ 100 Bases, 100 Bridges, 100 Base Inserts (Bulk)	B	100	100	\$2.62



522-5501



523-712W

# Adjustable & Multi-Purpose

**WiderSlider™**

**Slider™**

**SimpleStrap™**

**Support/Hyco Bars**



The durable WiderSlider™ bracket is made from galvanized 22-gauge steel. Pilot holes make it easier to install drop-ear elbows or other clamps. Bendable end tabs allow the bracket to set inside the stud cavity.





**WiderSlider™**

**Adjustable Multi-Purpose Bracket**

Item Number	Item Description	Pkg Type	Min Qty	Case Qty	Price
<b>9" - 15"</b>					
520-616	9" - 15" Galvanized Bracket	B	50	50	\$4.78
520-616PK	9" - 15" Galvanized Bracket	BI	50	50	\$4.96
<b>13" - 23"</b>					
520-626	13"-23" Galvanized Bracket	B	50	50	\$6.29
520-626PK	13"-23" Galvanized Bracket	BI	10	10	\$6.54



520-616



520-626

**Slider™**

**Adjustable Multi-Purpose Bracket**

Item Number	Item Description	Pkg Type	Min Qty	Case Qty	Price
<b>12" - 19"</b>					
520-19	12"-19" Galvanized, Self-Nailing	B	50	50	\$2.07
520-19C	12"-19" Copper Plated, Self-Nailing	B	50	50	\$4.12
520-19CPK	12"-19" Copper Plated, Self-Nailing	CI	25	25	\$4.37
520-19PK	12"-19" Galvanized, Self-Nailing	CI	50	50	\$2.32
520-19T	12"-19" Galvanized, Flat Tabs And Pilot Holes	B	50	50	\$2.35
520-19TC	12"-19" Copper Plated, Flat Tabs And Pilot Holes	B	50	50	\$4.17
520-419	12"-19" Galvanized, Self-Nailing And Pilot Holes	B	50	50	\$4.56
520-419T	12"-19" Galvanized, Flat Tabs And Pilot Holes	B	50	50	\$4.56
520-419TC	12" - 19" Copper Plated, Flat Tabs And Pilot Holes	B	50	50	\$5.93
<b>19" - 24"</b>					
520-24	19"-24" Galvanized, 3-Piece Assembly	B	25	25	\$2.80

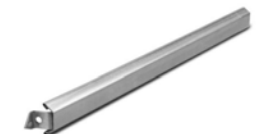

520-19



520-419

**SimpleStrap™**

**Cost-Effective Stub Out Bracket**

• Compatible with Copper, PEX or CPVC

Item Number	Item Description	Pkg Type	Min Qty	Case Qty	Price
<b>CLAMPS</b>					
525-02	1/2" CTS Simplestrap™	B	100	1000	\$0.56
525-02G	1/2" CTS Simplestrap™, Glueable To CPVC	B	100	1000	\$0.56
525-03	3/4" CTS Simplestrap™	B	100	1000	\$0.63
525-2002PK2	Kit: 20" Galvanized Bracket w/ Two 1/2" CTS Straps	BI	50	50	\$3.89
<b>BRACKETS</b>					
525-6920	Flat Bracket, 20"	B	100	100	\$1.90
525-6926	Flat Bracket, 26"	B	100	100	\$2.25



525-02



525-6920

Supply

Drainage

Support

Specialties

Appendix

**Support Bracket**

**Multi-Purpose Galvanized Bracket**



525-20B

Item Number	Item Description	Pkg Type	Min Qty	Case Qty	Price
<b>L-BENT</b>					
525-20B	L-Bent Bracket For 16" Stud Bays	B	100	100	\$1.63
525-27B	L-Bent Bracket For 24" Stud Bays	B	100	100	\$1.93
<b>FLAT</b>					
525-6920	Flat Bracket, 20"	B	100	100	\$1.90
525-6926	Flat Bracket, 26"	B	100	100	\$2.25

Supply

Drainage

Support

Specialties

Appendix

# Commercial Brackets

**Bell Hanger**

**Carrier Bracket**

**Chase Bracket**

**PipeTitan™**

**PowerBar™ Mini Strut**

**SaddleUp™**

**TD+™ Universal Clamp**

**Acoustical**

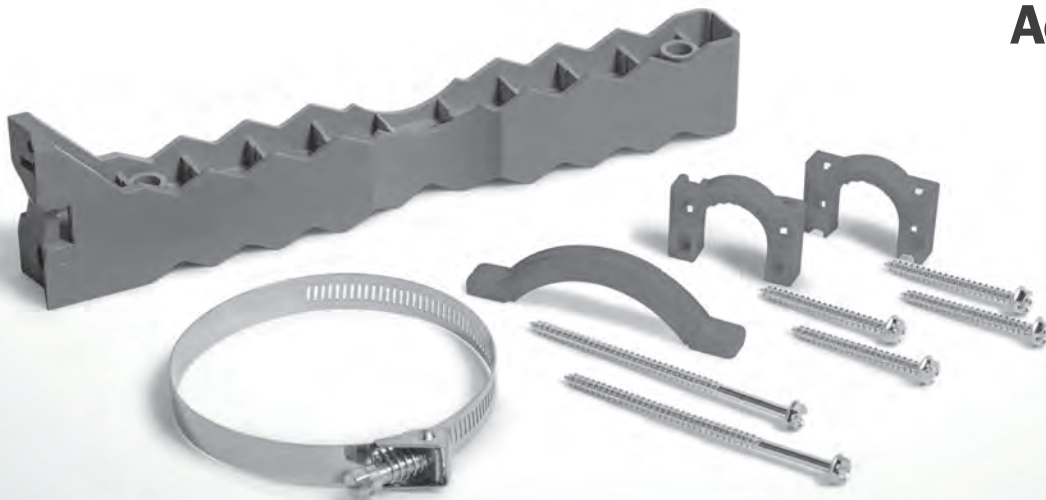



**508-2B**  
Page 533



**521-729**  
Page 533



**521-723**  
Page 533



**521-110**  
Page 534



**570-20**  
Page 534



**523-2MS2**  
Page 535



**523-1B**  
Page 535



**550-2111**  
Page 536

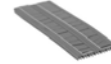

**575-102Q**  
Page 538

## CTS Bell Hanger

### Copper-Plated Steel

- Mounting screw included

Item Number	Item Description	Pkg Type	Min Qty	Case Qty	Price
508-2B	1/2" CTS, Bulk	B	25	25	\$2.79
508-2PK	1/2" CTS, 1/Bag	Cl	25	25	\$2.97
508-3B	3/4" CTS, Bulk	B	25	25	\$3.00
508-3PK	3/4" CTS, 1/Bag	Cl	25	25	\$3.04
508-4B	1" CTS, Bulk	B	25	25	\$3.17
508-4PK	1" CTS, 1/Bag	Cl	25	25	\$3.18



508-2B

## Carrier Bracket

### Copper-Plated

- Flush Valve Stubout bracket for wall-hung water closets

#### Related Products

Sweat Stub Out p 113

Item Number	Item Description	Pkg Type	Min Qty	Case Qty	Price
521-725	1" CTS × 4-1/2" Offset Centerline, Washers Included	B	5	5	\$16.55
521-728	1" CTS × 4-1/2" Offset Centerline For Prefab, Washers Included	B	5	5	\$16.55
521-729	1" CTS × 4-3/4" Double Offset Centerline, Washers Included	B	5	5	\$16.55
521-730	Carrier Bracket Height Extension Bracket	B	5	5	\$12.95



521-725

## ChaseBracket™

### Copper-Plated

- Supports copper water headers up to 3" diameter

Item Number	Item Description	Pkg Type	Min Qty	Case Qty	Price
521-723	J-Hook w/ 5" Stainless Snap-Lock Band, 16-Ga.	Bl	25	25	\$10.46
521-723BB	J-Hook Only 16-Ga.	B	25	25	\$10.13



521-723BB

Supply

Drainage

Support

Specialties

Appendix

Supply



521-110

### Commercial Alignment Bracket

#### Copper-Plated

Item Number	Item Description	Pkg Type	Min Qty	Case Qty	Price
521-110	Positioning Bracket For 1/2" Stub Outs On 4" Or 8" Centers	B	25	25	\$11.17
521-111	Stabilizing Combo Bracket For 1/2" And 3/4" Vertical Runs In Walls 3-1/2" Or Wider	B	50	50	\$12.05
521-112	Mid-Span Multi-Purpose Bracket w/ 3/4" Notches On 6" Centerline	B	50	50	\$11.87
521-113	Mid-Span Multi-Purpose Bracket w/ 3/4" Notches On 8" Centerline	B	50	50	\$11.87

Drainage

Support



570-22

### PipeTitan™

#### Universal Bracketing System

- Compatible with copper, PEX and CPVC
- Flame Retardant (Red) - Complies with UL94-V0

Item Number	Item Description	Pkg Type	Min Qty	Case Qty	Price
<b>STANDARD (GREEN)</b>					
570	Bracket Only	B	24	24	\$4.60
570-10	Kit: Bracket, 2 Straps, 1 Clamp	BI	24	24	\$8.66
570-20	Kit: Bracket, 2 Straps, 1 Clamp w/ 5" S/S Band	BI	24	24	\$10.46
570-22	Kit: Bracket, 2 Straps, 1 Clamp w/ 5" S/S Snap-Lock Band	BI	24	24	\$11.60
570-24	Kit: Bracket, 2 Straps, 1 Clamp w/ 7" S/S Snap-Lock Band	BI	24	24	\$12.46
<b>FLAME RETARDANT (RED)</b>					
572	Bracket Only	B	24	24	\$6.84
572-20	Kit: Fr Bracket, 2 Straps, 1 Clamp w/ 5" S/S Band	BI	24	24	\$13.69
572-22	Kit: Fr Bracket, 2 Straps 1 Clamp, w/ 5" S/S Snap-Lock Band	BI	24	24	\$14.96
572-24	Kit: Fr Bracket, 2 Straps 1 Clamp w/ 7" S/S Snap-Lock Band	BI	24	24	\$15.34
<b>CLAMPS, STRAPS, &amp; STAINLESS STEEL BANDS</b>					
570-53	Small Tube Strap w/ Screws	BI	50	1000	\$1.24
570-58	Large Pipe Clamp w/ Screws	BI	50	50	\$1.68
572-53	Fr Small Tube Strap w/ Screws	BI	50	250	\$1.48
574-72	5" Diameter Standard Stainless Steel Band	B	50	50	\$3.01
574-74	4" Diameter Snap-Lock Stainless Steel Band	B	50	50	\$3.78
574-75	5" Diameter Snap-Lock Stainless Steel Band	B	50	50	\$4.70
574-77	7" Diameter Snap-Lock Stainless Steel Band	B	50	50	\$5.36

Specialties



572-20

Appendix



570-53



570-58

**PowerBar™ Mini Strut**

**Suspension Support Bracket; Use with 3/8" Threaded Rod**

• Clamps 1/4" - 1" CTS tube & 1/8" - 1" Sch. 40 pipe

Item Number	Item Description	Pkg Type	Min Qty	Case Qty	Price
<b>LIGHT DUTY POWERBAR™ MINI STRUT (20-GA)</b>					
523-2MS	1 Bracket, 13-5/8"	B	50	50	\$2.76
523-2MS2	1 Bracket, 2 TouchDown Clamps	B	50	50	\$4.49
523-2MS3	1 Bracket, 3 TouchDown Clamps	B	50	50	\$5.02
523-2MS4	1 Bracket, 4 TouchDown Clamps	B	50	50	\$5.69
<b>HEAVY DUTY POWERBAR™ MINI STRUT (16-GA)</b>					
523-3MSL	Long Bracket Only, 26"	B	25	25	\$7.63
523-3MSS	Short Bracket Only, 15"	B	25	25	\$3.90
523-3MSS2	Short Bracket, 15" w/ 2 TouchDown Clamps	B	25	25	\$6.68
523-3MSS3	Short Bracket, 15" w/ 3 TouchDown Clamps	B	25	25	\$7.27
<b>TOUCHDOWN™ CLAMP</b>					
522-5500	100 Bases, 100 Bridges, 100 Base Inserts (Bulk)	B	100	100	\$0.64
522-5501	1 Bridge, 1 Clamp Base, 1 Base Insert (1 Set/Bag)	B	100	100	\$1.10
523F5500	Plenumsafe™ 100 Bases, 100 Bridges, 100 Base Inserts (Bulk)	B	100	100	\$2.62
<b>POWERBAR™ MINI STRUT CLAMPS (COPPER-PLATED)</b>					
523-3MS2C	1/2" CTS w/ #8 × 3/4" Screw	B	25	100	\$1.09
523-3MS3C	3/4" CTS w/ #8 × 3/4" Screw	B	25	100	\$1.12
523-3MS4C	1" CTS w/ 5/16-18 Bolt	B	10	50	\$1.46
523-3MS5C	1-1/4" CTS w/ 5/16-18 Bolt	B	10	50	\$1.71
523-3MS6C	1-1/2" CTS w/ 5/16-18 Bolt	B	10	50	\$1.99
523-3MS7C	2" CTS w/ 5/16-18 Bolt	B	10	50	\$2.26
<b>POWERBAR™ MINI STRUT CLAMPS (ZINC-PLATED)</b>					
523-3MS2G	1/2" IPS w/ #8 × 3/4" Screw	B	25	100	\$1.04
523-3MS3G	3/4" IPS w/ #8 × 3/4" Screw	B	25	100	\$1.07
523-3MS4G	1" IPS w/ 5/16-18 Bolt	B	10	50	\$1.40
523-3MS5G	1-1/4" IPS w/ 5/16-18 Bolt	B	10	50	\$1.62
523-3MS6G	1-1/2" IPS w/ 5/16-18 Bolt	B	10	10	\$1.90
523-3MS7G	2" IPS w/ 5/16-18 Bolt	B	10	10	\$2.16
523-3MS8G	3" IPS w/ 5/16-18 Bolt	B	10	10	\$2.69
523-3MS9G	4" IPS w/ 5/16-18 Bolt	B	10	10	\$3.15



523-2MS2



523-3MSS3



522-5501



523-3MS2C



523-3MS4G

**SaddleUp™**

**DWV Saddle Clamp**

Item Number	Item Description	Pkg Type	Min Qty	Case Qty	Price
<b>SADDLE-UP™ CLAMPS</b>					
523-1	SaddleUp™ Galvanized DWV Clamp	B	50	50	\$1.55
523-1B	Clamp w/ 5" Snap-Lock S/S Band	B	5	50	\$5.26
523-1C	Clamp w/ 4" Snap-Lock S/S Band	B	5	50	\$4.90
523-1D	Clamp w/ 3" Snap-Lock S/S Band	B	5	50	\$4.54



523-1

**SaddleUp™ (Cont)**

**DWV Saddle Clamp**



523-1B

Item Number	Item Description	Pkg Type	Min Qty	Case Qty	Price
<b>BULK STAINLESS STEEL BANDS</b>					
574-72	5" Diameter Standard Stainless Steel Band	B	50	50	\$3.01
574-74	4" Diameter Snap-Lock Stainless Steel Band	B	50	50	\$3.78
574-75	5" Diameter Snap-Lock Stainless Steel Band	B	50	50	\$4.70
574-77	7" Diameter Snap-Lock Stainless Steel Band	B	50	50	\$5.36
574-710	10" Diameter Snap-Lock Stainless Steel Band	B	10	10	\$7.29
574-713	13" Diameter Snap-Lock Stainless Steel Band	B	10	10	\$9.84

**TD+™ Universal Clamps**

· Clamps 1/2" CTS through 2" IPS



550-2111



550-2121



550-3131

Item Number	Item Description	Pkg Type	Min Qty	Case Qty	Price
<b>TD+™ FLAT BASE CLAMP</b>					
550-2111	TD+ Clamp Base, Bridge And Screws, 1/Bag	BI	50	50	\$3.57
550-2111PK2	1 Base, 1 Bridge, 2 Screws, 10/Box	CI	10	10	\$4.32
550-2111PK3	50 Bases, 50 Bridges, 100 Screws (Contr Pack) Bulk	B	1	1	\$178.50
550-2112	TD+ Clamp Base, 2 Bridges And Screws	BI	1	25	\$4.53
550-2113	1 Base, 3 Bridges, 2 Screws	BI	1	25	\$5.47
<b>TD+ STRUT BASE CLAMP</b>					
550-210	Bridge Only	B	25	250	\$1.28
550-2121	1 Base, 1 Bridge, 1/Bag	BI	50	50	\$4.14
550-2121PK3	50 Bases, 50 Bridges, (Contr Pack) Bulk	B	1	1	\$207.00
550-2122	1 Base, 2 Bridges	BI	1	25	\$5.02
<b>3/8" THREADED ROD</b>					
550-3131	1 Base, 1 Bridge, 1/Bag	BI	50	50	\$4.14
550-3131PK3	50 Bases, 50 Bridges, (Contr Pack) Bulk	BI	1	1	\$207.00
550-3132	1 Base, 2 Bridges	BI	25	25	\$5.02

Supply

Drainage

Support

Specialties

Appendix



**TD+™ Plenum-Rated Universal Clamps**

Item Number	Item Description	Pkg Type	Min Qty	Case Qty	Price
<b>PIPE CLAMP</b>					
550F3111	TD+ Clamp Base, Bridge And Screws	Bl	25	25	\$10.99
<b>STRUT CLAMP</b>					
550F3121	1 Base, 1 Bridge, 1/Bag	Bl	10	10	\$11.22
550F3121PK3	50 Bases, 50 Bridges, (Contr Pack) Bulk	Bl	1	1	\$561.00
<b>3/8" THREADED ROD</b>					
550F3131	1 Base, 1 Bridge, 1/Bag	Bl	10	10	\$11.22
550F3131PK3	50 Bases, 50 Bridges, (Contr Pack) Bulk	Bl	1	1	\$561.00



550F3111



550F3121



550F3131

**Acoustical TD+™ Universal Clamps**

· Clamps 1/2" CTS through 2" IPS

Item Number	Item Description	Pkg Type	Min Qty	Case Qty	Price
<b>PIPE CLAMP</b>					
550-2111Q	TD+ Clamp, 1 Base, 1 Bridge, 2 Screws, 2 PipeDown™ Cushions	Bl	1	50	\$5.41
550-2111QPK2	TD+ Clamp, 1 Base, 1 Bridge, 2 Screws, 2 PipeDown™ Cushions, 10/Box	Cl	10	10	\$6.16
550-2112Q	TD+ Clamp, 1 Base, 2 Bridges, 2 Screws, 4 PipeDown™ Cushions	Bl	1	25	\$6.43
<b>STRUT CLAMP</b>					
550-2121Q	TD+ Clamp, 1 Base, 1 Bridge, 2 PipeDown™ Cushions	Bl	1	25	\$6.29
550-2122Q	TD+ Clamp, 1 Base, 2 Bridges, 4 PipeDown™ Cushions	Bl	1	25	\$7.26
<b>ACCESSORIES</b>					
550-214QPK2	PipeDown™ Acoustical Cushion, 10/Bag	Cl	1	10	\$13.98
550-214QPK3	PipeDown™ Acoustical Cushion (Contr Pack), 50/Bag	Bl	1	4	\$55.99



550-2111Q



550-2112Q

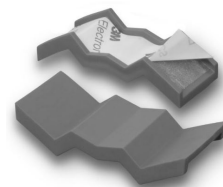

550-214QPK2

Supply

Drainage

Support

Specialties

Appendix

**Acoustical Isolation Accessories**

· CPVC compatible adhesive



575-100Q



575-510Q

Item Number	Item Description	Pkg Type	Min Qty	Case Qty	Price
<b>FELT &amp; LINER</b>					
575-100Q	2-1/4" × 100' × 1/8" Self-Adhesive Felt (Roll)	B	1	12	\$86.11
575-101Q	3/4" W × 25' (Roll)	B	1	10	\$109.91
575-102Q	2" W × 25' Self-Adhesive (Roll)	B	1	10	\$273.83
<b>CUSHIONS</b>					
575-510Q	PipeDown™ 2" × 2" × 3/4" Bumperpad™	B	25	25	\$2.04
575-511Q	PipeDown™ 2" × 2" × 3/4" Bumperpad™ w/ Flat Plate	B	25	25	\$4.31
575-512Q	PipeDown™ 2" × 2" × 3/4" Bumperpad™ w/ Formed Plate	B	25	25	\$4.31

Supply

Drainage

Support

Specialties

Appendix

**Manifold Bracket**

**Plastic**

Item Number	Item Description	Pkg Type	Min Qty	Case Qty	Price
550-AMB	PEX Manifold Bracket w/ Components, 1 Pair/Bag	BI	10	10	\$31.05



550-AMB

Supply

Drainage

Support

Specialties

Appendix

### Roof Top Block

Item Number	Item Description	Pkg Type	Min Qty	Case Qty	Price
<b>ROOF TOP BLOCK SUPPORT BRACKET</b>					
543-21	TakeOff™ Roof Top Support Block - Adjustable Bracket	B	8	8	\$19.00
<b>ACCESSORIES</b>					
543-21R	Roller Support Assembly Kit for 3/8" Thread Rod	BI	8	8	\$10.50



543-21



543-21R

Supply

Drainage

Support

Specialties

Appendix

# Overhead Brackets

**PipeEye™ Suspension Bracket**

**Beam Clamps & Connectors**

**Adjustable Swivel/Loop**

**Clevis Hangers**

**Split-Ring Hangers**

**Strut Clamps**

**Cushion Clamps**

**Saddle Shields**

**Sioux Chief  
Sammys**





## PipeEye™ Suspension Bracket

### Galvanized Steel

· Use with PipeEye™ insulators

#### Related Products

PipeEye™ Insulators p 483

Item Number	Item Description	Pkg Type	Min Qty	Case Qty	Price
521-557	Single Hole	B	25	25	\$1.67
521-558	Double Hole	B	25	25	\$1.85
521-559	Quadruple Hole	B	25	25	\$2.46

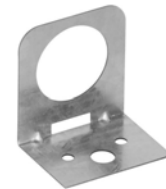

521-557

## Beam Clamp & Connector Products

### Accepts 3/8" Thread Rod

Item Number	Item Description	Pkg Type	Min Qty	Case Qty	Price
<b>TOP PLATE CONNECTOR</b>					
541-CB	Copper-Plated Steel (Bulk)	B	25	25	\$2.85
541-CPK2	Copper-Plated Steel, 1/Bag	CI	20	20	\$3.18
541-GB	Zinc-Plated Steel (Bulk)	B	25	25	\$2.26
541-GPK2	Zinc-Plated Steel, 1/Bag	CI	20	20	\$2.52
<b>TOP BEAM CLAMP (IMPORT)</b>					
542-PK2	Ductile Iron, 1/Bag	CI	10	10	\$4.37



541-CB



542-PK2

## Adjustable Swivel/Loop

Item Number	Item Description	Pkg Type	Min Qty	Case Qty	Price
<b>GALVANIZED</b>					
514-G02	1/2" IPS	B	100	100	\$0.92
514-G03	3/4" IPS	B	100	100	\$0.96
514-G04	1" IPS	B	100	100	\$1.00
514-G05	1-1/4" IPS	B	100	100	\$1.08
514-G06	1-1/2" IPS	B	100	100	\$1.09
514-G07	2" IPS	B	100	100	\$1.19
<b>ACOUSTICAL</b>					
514-G02Q	1/2" CTS	B	50	50	\$3.82
514-G03Q	3/4" CTS	B	50	50	\$4.03
514-G04Q	1" CTS	B	25	25	\$4.23
514-G05Q	1-1/4" CTS	B	25	25	\$4.66
514-G06Q	1-1/2" CTS	B	25	25	\$5.21
514-G07Q	2" CTS	B	10	10	\$5.55

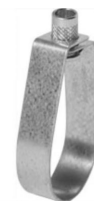

514-G02



514-G02Q



515-2CPK2



515-2GPK2

### Clevis hanger

· Complies with MSS-SP58 Type 1 requirements

Item Number	Item Description	Pkg Type	Min Qty	Case Qty	Price
<b>COPPER-PLATED</b>					
515-2CPK2	1/2" CTS, 1/Bag	CI	10	10	\$2.68
515-3CPK2	3/4" CTS, 1/Bag	CI	10	10	\$2.72
515-4CPK2	1" CTS, 1/Bag	CI	10	10	\$2.77
515-5CPK2	1-1/4" CTS, 1/Bag	CI	10	10	\$3.01
515-6CPK2	1-1/2" CTS, 1/Bag	CI	10	10	\$3.20
515-7CPK2	2" CTS, 1/Bag	CI	10	10	\$3.68
<b>GALVANIZED</b>					
515-2GPK2	1/2" IPS, 1/Bag	CI	10	10	\$2.39
515-3GPK2	3/4" IPS, 1/Bag	CI	10	10	\$2.48
515-4GPK2	1" IPS, 1/Bag	CI	10	10	\$2.49
515-5GPK2	1-1/4" IPS, 1/Bag	CI	10	10	\$2.85
515-6GPK2	1-1/2" IPS, 1/Bag	CI	10	10	\$3.24
515-7GPK2	2" IPS, 1/Bag	CI	10	10	\$4.06
515-8GPK2	2-1/2" IPS, 1/Bag	CI	10	10	\$5.48
515-9GPK2	3" IPS, 1/Bag	CI	10	10	\$6.17
515-10GPK2	4" IPS, 1/Bag	CI	10	10	\$6.63

### Split Ring Hanger

· Complies with MSS-SP58 Type 13 requirements



516-2CPK2



516-2GPK2



516-2CB

Item Number	Item Description	Pkg Type	Min Qty	Case Qty	Price
<b>EPOXY-COATED IRON W/ CU COLOR (IMPORTED)</b>					
516-2CPK2	1/2" CTS, 1/Bag	CI	20	20	\$2.74
516-3CPK2	3/4" CTS, 1/Bag	CI	20	20	\$2.90
516-4CPK2	1" CTS, 1/Bag	CI	10	10	\$3.35
516-5CPK2	1-1/4" CTS, 1/Bag	CI	10	10	\$3.84
516-6CPK2	1-1/2" CTS, 1/Bag	CI	10	10	\$4.23
516-7CPK2	2" CTS, 1/Bag	CI	10	10	\$5.01
<b>GALVANIZED IRON (IMPORTED)</b>					
516-2GPK2	1/2" IPS, 1/Bag	CI	20	20	\$2.47
516-3GPK2	3/4" IPS, 1/Bag	CI	20	20	\$2.80
516-4GPK2	1" IPS, 1/Bag	CI	10	10	\$2.90
516-5GPK2	1-1/4" IPS, 1/Bag	CI	10	10	\$3.79
516-6GPK2	1-1/2" IPS, 1/Bag	CI	10	10	\$4.15
516-7GPK2	2" IPS, 1/Bag	CI	10	10	\$4.53
<b>COPPER-PLATED STEEL (DOMESTIC)</b>					
516-2CB	1/2" CTS	B	100	100	\$3.42
516-4CB	1" CTS	B	100	100	\$3.69
516-5CB	1-1/4" CTS	B	100	100	\$4.11
516-6CB	1-1/2" CTS	B	100	100	\$4.45
516-7CB	2" CTS	B	100	100	\$5.13



## Split Ring Hanger (Cont)

Item Number	Item Description	Pkg Type	Min Qty	Case Qty	Price
<b>GALVANIZED STEEL (DOMESTIC)</b>					
516-2GB	1/2" IPS	B	100	100	\$3.56
516-3GB	3/4" IPS	B	100	100	\$3.69
516-4GB	1" IPS	B	100	100	\$4.06
516-5GB	1-1/4" IPS	B	100	100	\$4.55



516-4GB

## Strut Clamps

Item Number	Item Description	Pkg Type	Min Qty	Case Qty	Price
<b>COPPER ZINC DICHROMATE</b>					
517-C02	1/2" CTS, 1/Bag	BI	100	100	\$1.37
517-C03	3/4" CTS, 1/Bag	BI	100	100	\$1.51
517-C04	1" CTS, 1/Bag	BI	100	100	\$1.64
517-C05	1-1/4" CTS, 1/Bag	BI	50	50	\$1.82
517-C06	1-1/2" CTS, 1/Bag	BI	50	50	\$2.07
517-C07	2" CTS, 1/Bag	BI	50	50	\$2.47
517-C08	2-1/2" CTS, 1/Bag	BI	50	50	\$3.24
517-C09	3" CTS, 1/Bag	BI	50	50	\$3.36
517-C10	4" CTS, 1/Bag	BI	25	25	\$4.94
<b>ZINC-PLATED</b>					
517-G02	1/2" IPS, 1/Bag	BI	100	100	\$1.08
517-G03	3/4" IPS, 1/Bag	BI	100	100	\$1.18
517-G04	1" IPS, 1/Bag	BI	100	100	\$1.25
517-G05	1-1/4" IPS, 1/Bag	BI	100	100	\$1.30
517-G06	1-1/2" IPS, 1/Bag	BI	50	50	\$1.95
517-G07	2" IPS, 1/Bag	BI	50	50	\$2.07
517-G08	2-1/2" IPS, 1/Bag	BI	50	50	\$2.30
517-G09	3" IPS, 1/Bag	BI	25	25	\$2.86
517-G10	4" IPS, 1/Bag	BI	25	25	\$3.37



517-C02



517-G02

## Copper Tube Cushion Clamps

Item Number	Item Description	Pkg Type	Min Qty	Case Qty	Price
<b>STEEL CLAMP WITH TPR CUSHION/ISOLATOR</b>					
517-I062PK2	1/2" CTS (.625 O.D.), 1/Bag	BI	1	25	\$4.90
517-I087PK2	3/4" CTS (.875 O.D.), 1/Bag	BI	1	25	\$5.14
517-I112PK2	1" CTS (1.125 O.D.), 1/Bag	BI	1	20	\$5.63
517-I137PK2	1-1/4" CTS (1.375 O.D.), 1/Bag	BI	1	20	\$6.38
517-I162PK2	1-1/2" CTS (1.625 O.D.), 1/Bag	BI	1	20	\$7.56
517-I212PK2	2" CTS (2.125 O.D.), 1/Bag	BI	1	10	\$10.51



517-I062PK2

## Sioux Chief Sammys - Thread Rod Anchors

### Accepts 3/8" Thread Rod

Item Number	Item Description	Pkg Type	Min Qty	Case Qty	Price
<b>WOOD APPLICATIONS</b>					
590-4411	1/4" x 2" Screw, Vertical, 25/Box	BI	1	5	\$45.48
590-4411-3	1/4" x 3" Screw, Vertical, 25/Box	BI	1	5	\$47.14
590-4421	1/4" x 2" Screw, Horizontal, 25/Box	BI	1	5	\$56.29
<b>CONCRETE APPLICATIONS</b>					
590-4412	1/4" x 1-3/4" Screw, Vertical, 25/Box	BI	1	5	\$52.51
<b>STEEL BEAM APPLICATIONS</b>					
590-4413	1/4" x 1-1/4" Screw, Vertical, 25/Box	BI	1	5	\$46.30
590-4423	1/4" x 1-1/4" Screw, Horizontal, w/ Nut, 25/Box	BI	1	5	\$68.23
<b>INSTALLATION TOOLS</b>					
590-44ND1	Nut Driver #14 For Vertical Anchors (Black), 1/Bag	BI	1	12	\$24.25
590-44ND2	Nut Driver #14SW For Horizontal Anchors (Red), 1/Bag	BI	1	12	\$24.25



Supply

Drainage

Support

Specialties

Appendix

# **Stud Guards & Safety Plates**

**Stud Guards**

**Stud Shoe**

**Shield Plate**





**Stud Guard**

**Self-Nailing**

Item Number	Item Description	Pkg Type	Min Qty	Case Qty	Price
530-163	1-1/2" x 3", 16-Ga	B	100	100	\$0.49
530-1635	3" x 5", 16-Ga	B	100	100	\$1.19
530-163PK	1-1/2" x 3", 16-Ga IBC	BI	100	100	\$0.74
530-166	1-1/2" x 6", 16-Ga	B	100	100	\$0.74
530-166PK	1-1/2" x 6", 16-Ga IBC	CI	100	100	\$0.99
530-166PK3	1-1/2" x 6", 16-Ga, (Contr Pack), 100/Box	BI	1	1	\$74.00
530-169	1-1/2" x 9, 16-Ga	B	50	50	\$1.42
536-35	3" x 5", 16-Ga w/ Offset Nail Spikes	B	100	100	\$1.19
536-36	3-1/2" x 6", 16-Ga	B	50	50	\$1.71
536-56E	5" x 6", 16-Ga w/ Offset Nail Spikes	B	50	50	\$3.44
536-58	5" x 8", 16-Ga w/ Nail Spikes And 6 Nail Holes	B	50	50	\$3.67
536-68E	6" x 8", 16-Ga w/ Offset Nail Spikes	B	50	50	\$8.21



530-163

**Stud Guard**

**Metal Studs**

Item Number	Item Description	Pkg Type	Min Qty	Case Qty	Price
530-6M	1-1/2" x 6", 16-Ga w/ Nail Holes	B	100	100	\$0.74



530-6M

**Stud Shoe**

· Meets IRC 602.6 requirements

Item Number	Item Description	Pkg Type	Min Qty	Case Qty	Price
533-1	Single, 16-Ga	B	25	25	\$5.25
533-2	Double, 16-Ga	B	25	25	\$8.36
533-3	Triple, 16-Ga	B	10	10	\$9.53



533-1

Supply

Drainage

Support

Specialties

Appendix

Shield Plate

Item Number	Item Description	Pkg Type	Min Qty	Case Qty	Price
536-09	1-1/2" x 9" w/ 8 Holes 16-Ga	B	50	50	\$1.30
536-12	1-1/2" x 12" w/ 8 Holes 16-Ga	B	50	50	\$1.65
536-18	1-1/2" x 18" w/ 16 Holes 16-Ga	B	50	50	\$2.51
536-612	6" x 12" w/ 16 Holes 16-Ga	B	25	25	\$5.65
536-616	6" x 16" w/ 2 Holes 16-Ga. Galvanized	B	25	25	\$7.62
536-85	5" x 8" w/ 6 Holes 16-Ga	BI	50	50	\$3.59
538-09	1-1/2" x 9" w/ 8 Holes 18-Ga	B	50	50	\$1.15
538-09PK	1-1/2" x 9" w/ 8 Holes 18-Ga	BI	50	50	\$1.65
538-12	1-1/2" x 12" w/ 8 Holes 18-Ga	B	50	50	\$1.38
538-18	1-1/2" x 18" w/ 16 Holes 18-Ga	B	50	50	\$2.15
539-18	3-1/2" x 18" w/ 16 Holes 16-Ga	B	25	25	\$5.02
539-518	5" x 18" w/ 16 Holes 16-Ga	B	25	25	\$7.86
539-6	3-1/2" x 6" w/ 6 Holes 16-Ga	B	50	50	\$1.80



Supply

Drainage

Support

Specialties

Appendix

# **Water Heater Accessories**

**Water Heater Stands**

**Expansion Tank Support Kits**







## Water Heater Stand

- Meets National Fuel Gas Code requirements

Item Number	Item Description	Pkg Type	Min Qty	Case Qty	Price
598-010	21 × 21 × 18 Standard For 30-50-Gal Units	BI	1	1	\$95.66
598-011	21 × 21 × 18 Fast Assembly For 30-50 Gal Units	BI	1	1	\$95.66
598-012	24 × 24 × 18 Heavy Duty For 50-100 Gal Units	BI	1	1	\$192.20

## Expansion Tank Support Kits

- 2-gallon and 5-gallon options for vertical and horizontal installations

Item Number	Item Description	Pkg Type	Min Qty	Case Qty	Price
<b>SADDLEUP™ EXPANSION TANK SUPPORT KIT</b>					
598-0210	10" Max Diameter Band, Bracket And Screws - Contractor Pack	B	10	10	\$8.68
598-0210PK1	Kit: 10" Max Diameter Band, Bracket And Screws, 1/Bag	BI	1	25	\$11.43
598-0210PK2	Kit: 10" Max Diameter Band, Bracket And Screws, 2/Bag	BI	1	25	\$20.11
598-0213	13" Max Diameter Band, Bracket And Screws - Contractor Pack	B	10	10	\$9.84
598-0213PK1	Kit: 13" Max Diameter Band, Bracket And Screws, 1/Bag	BI	1	25	\$12.59
598-0213PK2	Kit: 13" Max Diameter Band, Bracket And Screws, 2/Bag	BI	1	25	\$22.43
<b>TANK™ BRACKET</b>					
598-022	2 pc. TANK Bracket - Leg/Foot/Ties, 1/Bag	BI	10	10	\$24.00
598-023	3 pc. TANK Bracket - Leg/Foot/Arm/Ties, 1/Bag	BI	10	10	\$28.50



598-0210



598-022



598-023



# Specialties

**Tubular**

**Plumbing Specialties**

**Tubing & Hose**

**Tubing/Hose Fittings**

**Tools & Chemicals**

**»» Making it in America**



**Tubular**

**Plastic Tubular**

**Metal Tubular**

**Basket Strainers  
& Sink Drains**

**Bath Waste Drains**

# Tubular

## Plastic Tubular

White and black polypropylene tubular products designed in accordance with ASTM F409 Standard Specification for Thermoplastic Accessible and Replaceable Plastic Tube and Tubular Fittings.

## Metal Tubular

Brass and chrome-plated brass tubular products designed in accordance with ASME A112.18.2/CSA B125.2 Standard for Plumbing Waste Fittings.

## Basket Strainers & Sink Drains

A wide selection of basket strainer options for kitchen sinks, including KiwkFit™, Specification™ and BigBoy™ designs. Lavatory sink drains and drains for bar sinks also available.

## Bath Waste Drains

Brass and plastic waste/overflow fittings for bathtubs in trip-lever Ezy Touch® and Twist-N-Close™ designs. Chrome, satin nickel, and other finish options available.

# Plastic Tubular

**P-Traps**

**S-Traps**

**End Outlets**

**Center Outlets**

**Disposer Wastes**

**Sink Tailpieces  
& Extensions**

**Dishwasher Tailpieces**

**Waste Arms**

**Flexible Fittings**

**Accessories**





**230-0206101**  
Page 561



**230-0226301**  
Page 561



**230-0908101**  
Page 562



**230-1005101**  
Page 562



**230-1506101**  
Page 562



**230-181616101**  
Page 563



**230-270616101**  
Page 564



**230-290616201**  
Page 564



**230-320616101**  
Page 565



**230-40060450**  
Page 565



**230-450506132**  
Page 566



**230-58060825**  
Page 566



**230-600607101**  
Page 567



**230-8006125**  
Page 568



**230-8506101**  
Page 568



**231-1506101**  
Page 569



**988-5000**  
Page 570



**P-Traps**

**Standard**

• 1-1/2" P-traps include a 1-1/2" x 1-1/4" reducing slip joint washer

Item Number	Item Description	Pkg Type	Min Qty	Case Qty	Price
<b>LESS ADAPTER</b>					
230-0105101	1-1/4" w/ Poly Washer, White, 1/Bag	BI	25	25	\$2.18
230-0105201	1-1/4" w/ Soft Washer, White, 1/Bag	BI	25	25	\$2.18
230-0106101	1-1/2" w/ Poly Washer, White, 1/Bag	BI	50	50	\$2.20
230-0106201	1-1/2" w/ Soft Washer, White, 1/Bag	BI	50	50	\$2.20
230-0115101	1-1/4" w/ Poly Washer, Black, 1/Bag	BI	25	25	\$2.18
230-0115201	1-1/4" w/ Soft Washer, Black, 1/Bag	BI	25	25	\$2.18
<b>WITH THREADED ADAPTER</b>					
230-0206101	1-1/2" w/ PVC Trap Adapter & Poly Washers, White, 1/Bag	BI	50	50	\$2.22
230-0206201	1-1/2" w/ PVC Trap Adapter & Soft Washers, White, 1/Bag	BI	50	50	\$2.22
230-0316101	1-1/2" w/ ABS Trap Adapter & Poly Washers, Black, 1/Bag	BI	50	50	\$2.22
230-0316201	1-1/2" w/ ABS Trap Adapter & Soft Washers, Black, 1/Bag	BI	50	50	\$2.22
<b>WITH THREADED ADAPTER &amp; DEEP ESCUTCHEON</b>					
230-0226301	1-1/2" PVC Trap Adapter, Deep Escutcheon & Poly Washers, Chromed ABS, 1/Bag	BI	25	25	\$16.32
<b>WITH SOLVENT WELD ADAPTER</b>					
230-0406101	1-1/2" w/ PVC Solvent Weld Trap Adapter, PVC Wall Bend & Poly Washers, White, 1/Bag	BI	50	50	\$3.90
230-0406201	1-1/2" w/ PVC Solvent Weld Trap Adapter, PVC Wall Bend & Soft Washers, White, 1/Bag	BI	50	50	\$3.45
230-0516150	1-1/2" w/ ABS Solvent Weld Trap Adapter, ABS Wall Bend & Poly Washers, Black 1/Bag	BI	50	50	\$3.90



230-0105101



230-0206101



230-0226301



230-0406101

**P-Traps**

**Reversible**

• 1-1/2" P-traps include a 1-1/2" x 1-1/4" reducing slip joint washer

Item Number	Item Description	Pkg Type	Min Qty	Case Qty	Price
<b>WITH THREADED ADAPTER</b>					
230-0706101	1-1/2" w/ PVC Trap Adapter & Poly Washers, White, 1/Bag	BI	50	50	\$2.58
230-0706201	1-1/2" w/ PVC Trap Adapter & Soft Washers, White, 1/Bag	BI	50	50	\$2.58
230-0716101	1-1/2" w/ ABS Trap Adapter & Poly Washers, Black, 1/Bag	BI	50	50	\$2.58
230-0716201	1-1/2" w/ ABS Trap Adapter & Soft Washers, Black, 1/Bag	BI	50	50	\$2.58
230-0806101	1-1/2" w/ ABS Trap Adapter & Poly Washers, White, 1/Bag	BI	50	50	\$2.97
230-0806201	1-1/2" w/ ABS Trap Adapter & Soft Washers, White, 1/Bag	BI	50	50	\$2.97
<b>WITH THREADED ADAPTER &amp; DEEP ESCUTCHEON</b>					
230-0706401	1-1/2" w/ PVC Trap Adapter, Soft Washer & Deep Poly Escutcheon White, 1/Bag	BI	50	50	\$3.66



230-0706101



230-0706401

Supply

Drainage

Support

Specialties

Appendix

Supply

Drainage

Support

Specialties

Appendix



230-0908101



230-1005101



230-1106101



230-1106301



230-1505101



230-170607101

### P-Traps

#### Repair

· 1-1/2" P-traps include a 1-1/2" x 1-1/4" reducing slip joint washer

Item Number	Item Description	Pkg Type	Min Qty	Case Qty	Price
230-0908101	1-1/2" w/ Poly Washers, White, 1/Bag	BI	12	12	\$10.57
230-0918101	1-1/2" w/ Poly Washers, Black, 1/Bag	BI	12	12	\$10.57

### S-Traps

· 1-1/2" S-traps include a 1-1/2" x 1-1/4" reducing slip joint washer

Item Number	Item Description	Pkg Type	Min Qty	Case Qty	Price
<b>LESS ADAPTER</b>					
230-1005101	1-1/4" w/ Poly Washers, White, 1/Bag	BI	10	10	\$7.59
230-1005201	1-1/4" w/ Soft Washers, White, 1/Bag	BI	10	10	\$7.97
230-1015101	1-1/4" w/ Poly Washers, Black, 1/Bag	BI	10	10	\$7.59
230-106101	1-1/2" w/ Poly Washers, White, 1/Bag	BI	10	10	\$8.00
<b>WITH THREADED ADAPTER</b>					
230-1106101	1-1/2" w/ PVC Trap Adapter & Poly Washers, White, 1/Bag	BI	10	10	\$8.61
230-1106201	1-1/2" w/ PVC Trap Adapter & Soft Washers, White, 1/Bag	BI	10	10	\$8.78
230-1116101	1-1/2" w/ ABS Trap Adapter & Poly Washers, Black, 1/Bag	BI	10	10	\$8.94
<b>WITH THREADED ADAPTER &amp; DEEP ESCUTCHEON</b>					
230-1106301	1-1/2" w/ PVC Trap Adapter, Deep Poly Escutcheon & Poly Washers, White, 1/Bag	BI	10	10	\$9.61

### Trap Accessories

Item Number	Item Description	Pkg Type	Min Qty	Case Qty	Price
<b>J-BEND</b>					
230-1505101	1-1/4" w/ Poly Washers, White, 1/Bag	BI	12	12	\$2.73
230-1506101	1-1/2" w/ Poly Washers, White, 1/Bag	BI	25	25	\$2.73
230-1516101	1-1/2" w/ Poly Washers, Black, 1/Bag	BI	25	25	\$2.73
<b>SINK TRAP J-BEND</b>					
230-1606101	1-1/2" w/ Poly Washers, White, 1/Bag	BI	12	12	\$3.56
230-1616101	1-1/2" w/ Poly Washers, Black, 1/Bag	BI	12	12	\$3.56
<b>WALL BEND</b>					
230-170507101	1-1/4" x 7", White, 1/Bag	BI	25	25	\$1.88
230-170607101	1-1/2" x 7", White, 1/Bag	BI	25	25	\$1.88

End Outlets

Telescoping

· End Outlets supplied with baffle tee

Item Number	Item Description	Pkg Type	Min Qty	Case Qty	Price
<b>ALL-PURPOSE</b>					
230-170616101	1-1/2" x 16" w/ Poly Washers, White, 1/Bag	BI	25	25	\$9.12
230-170616201	1-1/2" x 16" w/ Soft Washers, White, 1/Bag	BI	25	25	\$9.34
230-171616101	1-1/2" x 16" w/ Poly Washers, Black, 1/Bag	BI	25	25	\$9.57
230-180616101	1-1/2" x 16" w/ 1/2" Dishwasher Branch & Poly Washers, White, 1/Bag	BI	25	25	\$10.99
230-180616201	1-1/2" x 16" w/ 1/2" Dishwasher Branch & Soft Washers, White, 1/Bag	BI	25	25	\$11.27
230-181616101	1-1/2" x 16" w/ 1/2" Dishwasher Branch & Poly Washers, Black, 1/Bag	BI	25	25	\$11.01
230-190616101	1-1/2" x 16" w/ 3/4" Dishwasher Branch & Poly Washers, White, 1/Bag	BI	25	25	\$10.99
230-190616201	1-1/2" x 16" w/ 3/4" Dishwasher Branch & Soft Washers, White, 1/Bag	BI	25	25	\$11.27
230-191616101	1-1/2" x 16" w/ 3/4" Dishwasher Branch & Poly Washers, Black, 1/Bag	BI	25	25	\$11.01
<b>SLIP JOINT</b>					
230-200616101	1-1/2" x 16" w/ Poly Washers, White, 1/Bag	BI	25	25	\$7.72
230-200616201	1-1/2" x 16" w/ Soft Washers, White, 1/Bag	BI	25	25	\$7.92
230-201616101	1-1/2" x 16" w/ Poly Washers, Black, 1/Bag	BI	25	25	\$7.92
230-210616101	1-1/2" x 16" w/ 1/2" Dishwasher Branch & Poly Washers, White, 1/Bag	BI	25	25	\$8.31
230-210616201	1-1/2" x 16" w/ 1/2" Dishwasher Branch & Soft Washers, White, 1/Bag	BI	25	25	\$8.56
230-220616101	1-1/2" x 16" w/ 3/4" Dishwasher Branch & Poly Washers, White, 1/Bag	BI	10	10	\$8.31
230-220616201	1-1/2" x 16" w/ 3/4" Dishwasher Branch & Soft Washers, White, 1/Bag	BI	25	25	\$8.56
<b>DIRECT CONNECT</b>					
230-230616101	1-1/2" x 16" w/ Poly Washers, White, 1/Bag	BI	25	25	\$7.72
230-230616201	1-1/2" x 16" w/ Soft Washers, White, 1/Bag	BI	25	25	\$7.92
230-231616101	1-1/2" x 16" w/ Poly Washers, Black, 1/Bag	BI	25	25	\$7.92
230-240616101	1-1/2" x 16" w/ 1/2" Dishwasher Branch & Poly Washers, White, 1/Bag	BI	25	25	\$8.57
230-240616201	1-1/2" x 16" w/ 1/2" Dishwasher Branch & Soft Washers, White, 1/Bag	BI	25	25	\$8.77
230-241616101	1-1/2" x 16" w/ 1/2" Dishwasher Branch & Poly Washers, Black, 1/Bag	BI	25	25	\$8.77
230-250616101	1-1/2" x 16" w/ 3/4" Dishwasher Branch & Poly Washers, White, 1/Bag	BI	25	25	\$8.57
230-250616201	1-1/2" x 16" w/ 3/4" Dishwasher Branch & Soft Washers, White, 1/Bag	BI	25	25	\$8.77
230-251616101	1-1/2" x 16" w/ 3/4" Dishwasher Branch & Poly Washers, Black, 1/Bag	BI	25	25	\$8.77



230-170616101



230-181616101



230-200616101



230-240616201

Supply

Drainage

Support

Specialties

Appendix

Supply



230-2606101

Drainage



230-270616101

Support



230-280616101

Specialties

Appendix



230-2906101



230-300616101



230-310616101

## End Outlets

### Non-Telescoping

· End Outlets supplied with baffle tee

Item Number	Item Description	Pkg Type	Min Qty	Case Qty	Price
<b>ALL-PURPOSE</b>					
230-2606101	1-1/2" x 16" w/ Poly Washers, White, 1/Bag	BI	20	20	\$5.63
230-2606201	1-1/2" x 16" w/ Soft Washers, White, 1/Bag	BI	20	20	\$5.63
230-261616101	1-1/2" x 16" w/ Poly Washers, Black, 1/Bag	BI	25	25	\$5.78
<b>SLIP JOINT</b>					
230-270616101	1-1/2" x 16" w/ Poly Washers, White, 1/Bag	BI	25	25	\$5.52
230-270616201	1-1/2" x 16" w/ Soft Washers, White, 1/Bag	BI	25	25	\$5.66
230-270621101	1-1/2" x 21" w/ Poly Washers, White, 1/Bag	BI	25	25	\$15.18
230-270625101	1-1/2" x 25" w/ Poly Washers, White, 1/Bag	BI	25	25	\$16.77
230-271616101	1-1/2" x 16" w/ Poly Washers, Black, 1/Bag	BI	25	25	\$5.66
230-271616201	1-1/2" x 16" w/ Soft Washers, Black, 1/Bag	BI	25	25	\$5.66
230-271621101	1-1/2" x 21" w/ Poly Washers, Black, 1/Bag	BI	25	25	\$15.18
230-271625101	1-1/2" x 25" w/ Poly Washers, Black, 1/Bag	BI	25	25	\$16.77
<b>DIRECT CONNECT</b>					
230-280616101	1-1/2" x 16" w/ Poly Washers, White, 1/Bag	BI	25	25	\$5.41
230-280616201	1-1/2" x 16" w/ Soft Washers, White, 1/Bag	BI	25	25	\$5.53
230-281616101	1-1/2" x 16" w/ Poly Washers, Black, 1/Bag	BI	25	25	\$5.53

## Center Outlets

· Center Outlets supplied with baffle tee

Item Number	Item Description	Pkg Type	Min Qty	Case Qty	Price
<b>ALL-PURPOSE</b>					
230-2906101	1-1/2" x 16" w/ Poly Washers, White, 1/Bag	BI	10	10	\$7.30
230-290616201	1-1/2" x 16" w/ Soft Washers, White, 1/Bag	BI	25	25	\$7.48
230-291616101	1-1/2" x 16" w/ Poly Washers, Black, 1/Bag	BI	25	25	\$7.48
<b>SLIP JOINT</b>					
230-300616101	1-1/2" x 16" w/ Poly Washers, White, 1/Bag	BI	25	25	\$6.76
230-300616201	1-1/2" x 16" w/ Soft Washers, White, 1/Bag	BI	25	25	\$6.94
230-300621101	1-1/2" x 21" w/ Poly Washers, White, 1/Bag	BI	25	25	\$8.85
230-300625101	1-1/2" x 25" w/ Poly Washers, White, 1/Bag	BI	25	25	\$11.93
230-301616101	1-1/2" x 16" w/ Poly Washers, Black, 1/Bag	BI	25	25	\$6.94
230-301621101	1-1/2" x 21" w/ Poly Washers, Black, 1/Bag	BI	25	25	\$8.85
230-301625101	1-1/2" x 25" w/ Poly Washers, Black, 1/Bag	BI	25	25	\$11.93
<b>DIRECT CONNECT</b>					
230-310616101	1-1/2" x 16" w/ Poly Washers, White, 1/Bag	BI	25	25	\$6.76
230-310616201	1-1/2" x 16" w/ Soft Washers, White, 1/Bag	BI	25	25	\$6.94
230-311616101	1-1/2" x 16" w/ Poly Washers, Black, 1/Bag	BI	25	25	\$6.94

### Disposer Waste

· Disposer Wastes supplied with baffle tee

Item Number	Item Description	Pkg Type	Min Qty	Case Qty	Price
<b>DIRECT CONNECT - TELESCOPING</b>					
230-320616101	1-1/2" x 16" w/ Poly Washers & ISE® Gasket, White, 1/Bag	BI	25	25	\$6.55
230-320616201	1-1/2" x 16" w/ Soft Washers & ISE® Gasket, White, 1/Bag	BI	25	25	\$6.88
230-321616101	1-1/2" x 16" w/ Poly Washers & ISE® Gasket, Black, 1/Bag	BI	25	25	\$6.88
<b>DIRECT CONNECT - NON-TELESCOPING</b>					
230-330616101	1-1/2" x 16" w/ Poly Washers & ISE® Gasket, White, 1/Bag	BI	25	25	\$5.51
230-330616201	1-1/2" x 16" w/ Soft Washers & ISE® Gasket, White, 1/Bag	BI	25	25	\$5.97
230-331616101	1-1/2" x 16" w/ Poly Washers & ISE® Gasket, Black, 1/Bag	BI	25	25	\$5.97



230-320616101



230-330616101

### Sink Tailpieces

Item Number	Item Description	Pkg Type	Min Qty	Case Qty	Price
<b>FLANGED</b>					
230-40060125	1-1/2" x 1-1/4", White	BI	25	25	\$0.94
230-40060450	1-1/2" x 4", White	BI	50	50	\$1.26
230-40060650	1-1/2" x 6", White	BI	50	50	\$1.29
230-40060825	1-1/2" x 8", White	BI	25	25	\$1.29
230-40061225	1-1/2" x 12", White	BI	25	25	\$1.85
230-40160450	1-1/2" x 4", Black	BI	50	50	\$0.94
230-40160650	1-1/2" x 6", Black	BI	50	50	\$1.44
230-40160825	1-1/2" x 8", Black	BI	25	25	\$1.44
230-40161225	1-1/2" x 12", Black	BI	25	25	\$1.85
<b>DOUBLE FLANGED</b>					
230-41061625	1-1/2" x 16", White	BI	25	25	\$2.25
230-41161625	1-1/2" x 16", Black	BI	25	25	\$2.25



230-40060450



230-41061625

### Sink Tailpiece/Extension

Item Number	Item Description	Pkg Type	Min Qty	Case Qty	Price
<b>FLANGE x SLIP JOINT</b>					
230-44061625	1-1/2" x 16" w/ Soft Washer, White, 1/Bag	BI	25	25	\$2.72



230-44061625

Supply

Drainage

Support

Specialties

Appendix

**Extensions**

Item Number	Item Description	Pkg Type	Min Qty	Case Qty	Price
<b>SLIP EXTENSION</b>					
230-450506132	1-1/4" x 6" w/ Poly Washer, White, 1/Bag	BI	32	32	\$2.53
230-450506232	1-1/4" x 6" w/ Soft Washer, White, 1/Bag	BI	32	32	\$2.58
230-450508125	1-1/4" x 8" w/ Poly Washer, White, 1/Bag	BI	25	25	\$2.93
230-450508225	1-1/4" x 8" w/ Soft Washer, White, 1/Bag	BI	25	25	\$3.00
230-450512116	1-1/4" x 12" w/ Poly Washer, White, 1/Bag	BI	16	16	\$3.54
230-450512216	1-1/4" x 12" w/ Soft Washer, White, 1/Bag	BI	16	16	\$3.63
230-450606132	1-1/2" x 6" w/ Poly Washer, White, 1/Bag	BI	32	32	\$2.09
230-450606232	1-1/2" x 6" w/ Soft Washer, White, 1/Bag	BI	32	32	\$2.14
230-450608116	1-1/2" x 8" w/ Poly Washer, White, 1/Bag	BI	16	16	\$2.25
230-450608216	1-1/2" x 8" w/ Soft Washer, White, 1/Bag	BI	16	16	\$2.31
230-450612116	1-1/2" x 12" w/ Poly Washer, White, 1/Bag	BI	16	16	\$2.47
230-450612216	1-1/2" x 12" w/ Soft Washer, White, 1/Bag	BI	16	16	\$2.53
230-451506132	1-1/4" x 6" w/ Poly Washer, Black, 1/Bag	BI	32	32	\$2.58
230-451606132	1-1/2" x 6" w/ Poly Washer, Black, 1/Bag	BI	32	32	\$2.18
230-451608116	1-1/2" x 8" w/ Poly Washer, Black, 1/Bag	BI	16	16	\$2.39
230-451608216	1-1/2" x 8" w/ Soft Washer, Black, 1/Bag	BI	16	16	\$2.45
230-451612116	1-1/2" x 12" w/ Poly Washer, Black, 1/Bag	BI	16	16	\$2.64
<b>DOUBLE SLIP EXTENSION</b>					
230-460516125	1-1/4" x 16" w/ Poly Washers, White, 1/Bag	BI	25	25	\$4.32
230-460516225	1-1/4" x 16" w/ Soft Washers, White, 1/Bag	BI	25	25	\$4.32
230-460616125	1-1/2" x 16" w/ Poly Washers, White, 1/Bag	BI	25	25	\$2.81
230-460616225	1-1/2" x 16" w/ Soft Washers, White, 1/Bag	BI	25	25	\$3.27
230-461516125	1-1/4" x 16" w/ Poly Washers, Black, 1/Bag	BI	25	25	\$4.32
230-461616125	1-1/2" x 16" w/ Poly Washers, Black, 1/Bag	BI	25	25	\$3.31
230-461616225	1-1/2" x 16" w/ Soft Washers, Black, 1/Bag	BI	25	25	\$3.36
<b>SOLVENT WELD EXTENSION</b>					
230-47050650	1-1/4" x 6", PVC	BI	50	50	\$2.47
230-47050825	1-1/4" x 8", PVC	BI	25	25	\$2.54
230-47051225	1-1/4" x 12", PVC	BI	25	25	\$2.76
230-47060825	1-1/2" x 8", PVC	BI	25	25	\$3.39
230-47061225	1-1/2" x 12", PVC	BI	25	25	\$3.40
230-47150850	1-1/4" x 8", ABS	BI	50	50	\$2.62
230-47160625	1-1/2" x 6", ABS	BI	25	25	\$3.46
230-47161225	1-1/2" x 12", ABS	BI	25	25	\$3.48
<b>DOUBLE SOLVENT WELD EXTENSION</b>					
230-48061625	1-1/2" x 16", PVC	BI	25	25	\$4.90

**Dishwasher Tailpieces**

Item Number	Item Description	Pkg Type	Min Qty	Case Qty	Price
<b>ALL-PURPOSE</b>					
230-57060825	1-1/2" x 8" x 1/2" Branch w/ Poly Washers, White, 1/Bag	BI	25	25	\$5.08
230-58060825	1-1/2" x 8" x 3/4" Branch w/ Poly Washers, White, 1/Bag	BI	25	25	\$5.08

Supply

Drainage

Support

Specialties

Appendix



230-450506132



230-460516125



230-47050650



230-48061625



230-57060825

### Dishwasher Tailpieces (Cont)

Item Number	Item Description	Pkg Type	Min Qty	Case Qty	Price
<b>SLIP JOINT</b>					
230-530608225	1-1/2" x 8" x 1/2" Branch w/ Soft Washer, White, 1/Bag	Bl	25	25	\$2.71
230-53060825	1-1/2" x 8" x 1/2" Branch w/ Poly Washer, White, 1/Bag	Bl	25	25	\$2.60
230-53160825	1-1/2" x 8" x 1/2" Branch w/ Poly Washer, Black, 1/Bag	Bl	25	25	\$3.17
230-550608225	1-1/2" x 8" x 3/4" Branch w/ Soft Washer, White, 1/Bag	Bl	25	25	\$2.71
230-55060825	1-1/2" x 8" x 3/4" Branch w/ Poly Washer, White, 1/Bag	Bl	25	25	\$2.60
230-55160825	1-1/2" x 8" x 3/4" Branch w/ Poly Washer, Black, 1/Bag	Bl	25	25	\$3.17
<b>DIRECT CONNECT</b>					
230-54060825	1-1/2" x 8" x 1/2" Branch w/ Poly Washer, White, 1/Bag	Bl	25	25	\$2.67
230-54160825	1-1/2" x 8" x 1/2" Branch w/ Poly Washer, Black, 1/Bag	Bl	25	25	\$3.17
230-56060825	1-1/2" x 8" x 3/4" Branch w/ Poly Washer, White, 1/Bag	Bl	25	25	\$2.43
230-56160825	1-1/2" x 8" x 3/4" Branch w/ Poly Washer, Black, 1/Bag	Bl	25	25	\$3.17



230-53060825



230-54060825

### Waste Arms

Item Number	Item Description	Pkg Type	Min Qty	Case Qty	Price
<b>SLIP JOINT</b>					
230-600607101	1-1/2" x 7" w/ Poly Washer, White, 1/Bag	Bl	25	25	\$3.08
230-600609125	1-1/2" x 9-1/2" w/ Poly Washer, White, 1/Bag	Bl	25	25	\$3.76
230-600611125	1-1/2" x 11-1/2" w/ Poly Washer, White, 1/Bag	Bl	25	25	\$4.57
230-600615125	1-1/2" x 15" w/ Poly Washer, White, 1/Bag	Bl	25	25	\$5.92
230-600624125	1-1/2" x 24" w/ Poly Washer, White, 1/Bag	Bl	25	25	\$7.20
230-60160725	1-1/2" x 7" w/ Poly Washer, Black, 1/Bag	Bl	25	25	\$3.15
230-60160925	1-1/2" x 9-1/2" w/ Poly Washer, Black, 1/Bag	Bl	25	25	\$3.84
230-601611125	1-1/2" x 11-1/2" w/ Poly Washer, Black, 1/Bag	Bl	25	25	\$4.71
230-601615125	1-1/2" x 15" w/ Poly Washer, Black, 1/Bag	Bl	25	25	\$6.07
<b>DIRECT CONNECT</b>					
230-61060725	1-1/2" x 7" w/ Poly Washer, White, 1/Bag	Bl	25	25	\$3.08
230-61060925	1-1/2" x 9-1/2" w/ Poly Washer, White, 1/Bag	Bl	25	25	\$3.76
230-61061225	1-1/2" x 11-1/2" w/ Poly Washer, White, 1/Bag	Bl	25	25	\$4.57
230-61061525	1-1/2" x 15" w/ Poly Washer, White, 1/Bag	Bl	25	25	\$5.92
230-61160725	1-1/2" x 7" w/ Poly Washer, Black, 1/Bag	Bl	25	25	\$3.15
230-61160925	1-1/2" x 9-1/2" w/ Poly Washer, Black, 1/Bag	Bl	25	25	\$3.84
230-61161125	1-1/2" x 11-1/2" w/ Poly Washer, Black, 1/Bag	Bl	25	25	\$4.71
230-61161525	1-1/2" x 15" w/ Poly Washer, Black, 1/Bag	Bl	25	25	\$6.07



230-600607101



230-61060725

Supply

Drainage

Support

Specialties

Appendix

**Tubular Fittings**

Item Number	Item Description	Pkg Type	Min Qty	Case Qty	Price
<b>COUPLINGS</b>					
230-8006125	1-1/2" w/ Poly Washers, White, 1/Bag	BI	25	25	\$3.42
230-8016125	1-1/2" w/ Poly Washers, Black, 1/Bag	BI	25	25	\$3.51
<b>ELBOWS</b>					
230-8206125	1-1/2" 90 Degree Elbow w/ Poly Washers, White, 1/Bag	BI	25	25	\$3.37
230-8216125	1-1/2" 90 Degree Elbow w/ Poly Washers, Black, 1/Bag	BI	25	25	\$3.37
230-8406101	1-1/2" 45 Degree Elbow w/ Poly Washers, White, 1/Bag	BI	25	25	\$3.83
<b>TEE SLIP JOINT</b>					
230-8506101	1-1/2" w/ Poly Washers, White, 1/Bag	BI	25	25	\$3.29
230-8516101	1-1/2" w/ Poly Washers, Black, 1/Bag	BI	25	25	\$3.29
<b>TEE - CENTER OUTLET SLIP JOINT</b>					
230-860625	1-1/2" w/ Poly Washers, White, 1/Bag	BI	25	25	\$2.58
230-861625	1-1/2" w/ Poly Washers, Black, 1/Bag	BI	25	25	\$2.58
<b>TEE - END OUTLET SLIP JOINT</b>					
230-8706125	1-1/2" w/ Poly Washers, White, 1/Bag	BI	25	25	\$3.88
230-8716125	1-1/2" w/ Poly Washers, Black, 1/Bag	BI	25	25	\$4.32
<b>TEE - END OUTLET DIRECT CONNECT</b>					
230-8806125	1-1/2" w/ Poly Washers, White, 1/Bag	BI	25	25	\$3.88
230-8816125	1-1/2" w/ Poly Washers, Black, 1/Bag	BI	25	25	\$4.32
<b>DOUBLE OFFSET</b>					
230-9006101	1-1/2" w/ Poly Washers, White, 1/Bag	BI	25	25	\$8.47
<b>THREADED TRAP ADAPTER</b>					
230-9506101	PVC 1-1/2" Sch. 40 Hub w/ Nut & Poly Washer, White, 1/Bag	BI	25	25	\$1.74
230-9506GT	PVC 1-1/2 Hub Trap Adapter w/ GripTip Test Nut	B	25	25	\$1.73
230-9506SGT	PVC 1-1/2 Spigot Trap Adapter w/ GripTip Test Nut	B	25	25	\$1.98
230-9516101	ABS 1-1/2" Sch. 40 Hub w/ Nut & Poly Washer, Black, 1/Bag	BI	25	25	\$2.21
988-6GT	1-1/2" Trap Adapter Nut w/ GripTip	B	25	25	\$0.88



230-8006125



230-8206125



230-8506101



230-860625



230-9006101



230-9506GT

Supply

Drainage

Support

Specialties

Appendix



**Flexible Fittings**

Item Number	Item Description	Pkg Type	Min Qty	Case Qty	Price
<b>J-BEND</b>					
231-1506101	1-1/2" Or 1-1/4" w/ Poly Washers, White, 1/Bag	Bl	25	25	\$10.61
<b>FLANGED TAILPIECE</b>					
231-4006101	1-1/2", White, 1/Bag	Bl	15	15	\$6.71
<b>SLIP EXTENSION</b>					
231-4505101	1-1/4" w/ Poly Washer, White, 1/Bag	Bl	15	15	\$9.45
231-4506101	1-1/2" w/ Poly Washer, White, 1/Bag	Bl	15	15	\$9.45
<b>COUPLING</b>					
231-4606101	1-1/2" w/ Poly Washers, White, 1/Bag	Bl	25	25	\$10.61



231-1506101



231-4006101



231-4505101



231-4606101

Supply

Drainage

Support

Specialties

Appendix

**Plastic Tubular Accessories**

Item Number	Item Description	Pkg Type	Min Qty	Case Qty	Price
<b>SLIP NUTS</b>					
988-5000	1-1/4" , White	B	100	1000	\$0.31
988-5100	1-1/4" , Black	B	100	1000	\$0.36
988-6	1-1/2" , White	B	100	1000	\$0.31
988-6100	1-1/2" , Black	B	100	1000	\$0.36
<b>FLANGED TAILPIECE WASHERS</b>					
991-6	1-1/2" Polyethylene	B	100	1000	\$0.17
991-6S	1-1/2" Red, Soft TPV	B	100	1000	\$0.29
<b>BEVELED SLIP JOINT WASHERS</b>					
996-500	1-1/4" Polyethylene	B	100	1000	\$0.13
996-5S	1-1/4" Red, Soft TPV	B	100	1000	\$0.23
996-6	1-1/2" Polyethylene	B	100	1000	\$0.17
996-6S	1-1/2" Red, Soft TPV	B	100	1000	\$0.20
<b>REDUCING WASHERS</b>					
996-8	1-1/2" × 1-1/4" Polyethylene	B	100	1000	\$0.13
996-8S	1-1/2" × 1-1/4" Red, Soft TPV	B	100	1000	\$0.23
<b>DISPOSAL WASHER</b>					
290-20180	Replacement In-Sink-Erator Disposal Elbow Gasket Only	B	5	25	\$0.93
<b>TUBULAR TEST NUT</b>					
988-6GT	1-1/2" Trap Adapter Nut w/ GripTip	B	25	25	\$0.88
<b>TRAP ADAPTER TEST PLUG</b>					
234-QP	1-1/2" Trap Adapter Test Plug	B	25	100	\$1.09
234-QP2	1-1/4" Trap Adapter Test Plug	B	25	100	\$1.09



988-5000



991-6



996-500



996-6



996-8



290-20180



988-6GT

Supply

Drainage

Support

Specialties

Appendix

# Metal Tubular

**P-Traps**

**S-Traps**

**End Outlets**

**Center Outlets**

**Disposer Wastes**

**Sink Tailpieces  
& Extensions**

**Branch Tailpieces**

**Waste Arms**

**Threaded Tube**

**Accessories**





**240-0151C04**  
Page 573



**240-08648R104**  
Page 574



**240-20825C04**  
Page 575



**240-1052C04**  
Page 576



**240-1151C04**  
Page 577



**240-1551C12**  
Page 577



**240-276116C04**  
Page 578



**240-316116C04**  
Page 579



**240-336213C04**  
Page 579



**240-405104C50**  
Page 579



**240-465115C16**  
Page 581



**200-064**  
Page 582



**213-060**  
Page 583



**240-486124C04**  
Page 584



**240-616107C01**  
Page 585



**240-705206C50**  
Page 585



**240-8051C25**  
Page 586



**981-6**  
Page 587



**270-525**  
Page 588



**274-5**  
Page 588



**240-996208R116**  
Page 588

**P-Traps**

**Shallow Escutcheon**

Item Number	Item Description	Pkg Type	Min Qty	Case Qty	Price
<b>WITH SHALLOW ESCUTCHEON</b>					
240-0151C04	1-1/4" 22ga, Chrome, 1/Box	Bl	1	25	\$23.74
240-015212C04	1-1/4" w/ 12" Wall Tube, 20ga, Chrome, 1/Box	Bl	1	25	\$38.60
240-0152C04	1-1/4", 20ga, Chrome, 1/Box	Bl	1	25	\$27.28
240-015312C04	1-1/4" w/ 12" Wall Tube, 17ga, Chrome, 1/Box	Bl	1	25	\$40.21
240-01531C04	1-1/4" w/ Brass Nuts, 17ga, Chrome, 1/Box	Bl	1	25	\$39.78
240-0153C04	1-1/4", 17ga, Chrome, 1/Box	Bl	1	25	\$30.23
240-0161C04	1-1/2", 22ga, Chrome, 1/Box	Bl	1	25	\$29.51
240-0161R104	1-1/2", 22ga, Rough Brass, 1/Box	Bl	1	25	\$29.25
240-016215C04	1-1/2" w/ 12" Wall Tube, 20ga, Chrome, 1/Box	Bl	1	25	\$41.84
240-01621C04	1-1/2" w/ Brass Nuts, 20ga, Chrome, 1/Box	Bl	1	25	\$42.56
240-0162C04	1-1/2", 20ga, Chrome, 1/Box	Bl	1	25	\$37.95
240-0162R104	1-1/2", 20ga, Rough Brass, 1/Box	Bl	1	25	\$31.16
240-0163121C04	1-1/2" w/ 12" Wall Tube & Brass Nuts, 17ga, Chrome, 1/Box	Bl	1	25	\$52.82
240-016312C04	1-1/2" w/ 12" Wall Tube, 17ga, Chrome, 1/Box	Bl	1	25	\$48.03
240-01631C04	1-1/2" w/ Brass Nuts, 17ga, Chrome, 1/Box	Bl	1	25	\$46.46
240-0163C04	1-1/2", 17ga, Chrome, 1/Box	Bl	1	25	\$42.45
240-0163R104	1-1/2", 17ga, Rough Brass, 1/Box	Bl	1	25	\$37.62
<b>WITH CLEANOUT &amp; SHALLOW ESCUTCHEON</b>					
240-0452C04	1-1/4", 20ga, Chrome, 1/Box	Bl	1	25	\$37.11
240-0453C04	1-1/4", 17ga, Chrome, 1/Box	Bl	1	25	\$39.75
240-0454C04	1-1/4" w/ Cast Body, 17ga, Chrome, 1/Box	Bl	1	25	\$44.95
240-04571C04	1-1/4" w/ Cast Body & Brass Nuts, 17ga, Chrome, 1/Box	Bl	1	25	\$49.23
240-0462C04	1-1/2", 20ga, Chrome, 1/Box	Bl	1	25	\$41.80
240-04631C04	1-1/2" w/ Brass Nuts, 17ga, Chrome, 1/Box	Bl	1	25	\$45.36
240-0463C04	1-1/2", 17ga, Chrome, 1/Box	Bl	1	25	\$41.84
240-0464C04	1-1/2" w/ Cast Body, 17ga, Chrome, 1/Box	Bl	1	25	\$52.79
240-0467C04	1-1/2" w/ Cast Body & Brass Nuts, 17ga, Chrome, 1/Box	Bl	1	25	\$56.28
240-0487C04	1-1/2" x 1-1/4" w/ Cast Body, 17ga, Chrome, 1/Box	Bl	1	25	\$52.65
<b>LOW-INLET WITH SHALLOW ESCUTCHEON</b>					
240-01539C04	1-1/4" Low Inlet, 17ga, Chrome, 1/Box	Bl	1	25	\$43.25
240-01639C04	1-1/2" Low Inlet, 17ga Chrome, 1/Box	Bl	1	25	\$49.43
<b>CHOKE NECK WITH SHALLOW ESCUTCHEON</b>					
240-01831C04	1-1/2" x 1-1/4" w/ Brass Nuts, 17ga, Chrome, 1/Box	Bl	1	25	\$40.71
<b>GROUND JOINT WITH SHALLOW ESCUTCHEON</b>					
240-06631C04	1-1/2" w/ Brass Nuts, 17ga, Chrome, 1/Box	Bl	1	25	\$41.26



240-0151C04



240-0452C04



240-01539C04



240-01831C04



240-06631C04

Supply

Drainage

Support

Specialties

Appendix

Supply



240-0252C04

Drainage



240-0553C04

Support

Specialties

Appendix



240-03531C04



240-05B531C04



240-08648R104

**P-Traps**

**Deep Bell Escutcheon**

Item Number	Item Description	Pkg Type	Min Qty	Case Qty	Price
<b>WITH DEEP BELL ESCUTCHEON</b>					
240-0252C04	1-1/4", 20ga, Chrome, 1/Box	BI	1	25	\$28.34
240-025315C04	1-1/4" w/ 12" Wall Tube, 17ga, Chrome, 1/Box	BI	1	25	\$40.21
240-02531C04	1-1/4" w/ Brass Nuts, 17ga, Chrome, 1/Box	BI	1	25	\$40.94
240-0253C04	1-1/4", 17ga, Chrome, 1/Box	BI	1	25	\$31.11
240-0261C04	1-1/2", 22ga, Chrome, 1/Box	BI	1	25	\$33.01
240-0262C04	1-1/2", 20ga, Chrome, 1/Box	BI	1	25	\$38.80
240-026312C04	1-1/2" w/ 12" Wall Tube, 17ga, Chrome, 1/Box	BI	1	25	\$42.79
240-02631C04	1-1/2" w/ Brass Nuts, 17ga, Chrome, 1/Box	BI	1	25	\$42.02
240-0263C04	1-1/2", 17ga, Chrome, 1/Box	BI	1	25	\$38.48
<b>WITH CLEANOUT &amp; DEEP BELL ESCUTCHEON</b>					
240-0553C04	1-1/4", 17ga, Chrome, 1/Box	BI	1	25	\$46.53
240-05541C04	1-1/4" w/ Cast Body & Brass Nuts, 17ga, Chrome, 1/Box	BI	1	25	\$57.75
240-0554C04	1-1/4" w/ Cast Body, 17ga, Chrome, 1/Box	BI	1	25	\$50.23
240-0563C04	1-1/2", 17ga, Chrome, 1/Box	BI	1	25	\$46.35
240-0564C04	1-1/2" w/ Cast Body, 17ga, Chrome, 1/Box	BI	1	25	\$63.35

**P-Traps**

**Deep Box Escutcheon**

Item Number	Item Description	Pkg Type	Min Qty	Case Qty	Price
<b>WITH DEEP BOX ESCUTCHEON</b>					
240-03531C04	1-1/4" w/ Brass Nuts, 17ga, Chrome, 1/Box	BI	1	25	\$35.83
240-0353C04	1-1/4", 17ga, Chrome, 1/Box	BI	1	25	\$31.79
240-03631C04	1-1/2" w/ Brass Nuts, 17ga, Chrome, 1/Box	BI	1	25	\$41.76
240-0363C04	1-1/2", 17ga, Chrome, 1/Box	BI	1	25	\$39.18
<b>WITH CLEANOUT &amp; DEEP BOX ESCUTCHEON</b>					
240-05B531C04	1-1/4" w/ Brass Nuts, 17ga, Chrome, 1/Box	BI	1	25	\$41.14
240-05B631C04	1-1/2" w/ Brass Nuts, 17ga, Chrome, 1/Box	BI	1	25	\$47.10

**P-Traps**

**Regulation**

Item Number	Item Description	Pkg Type	Min Qty	Case Qty	Price
<b>REGULATION P-TRAPS</b>					
240-08648R104	L.A. Trap, 1-1/2" Slip Joint x 1-1/2" FIP, Cast Brass, Rough Brass, 1/Box	BI	1	5	\$49.56
240-08688R104	L.A. Trap, 1-1/2" Slip Joint x 1-1/2" Sweat, Cast Brass, Rough Brass, 1/Box	BI	1	5	\$49.97
240-08848C04	L.A. Trap, 1-1/4" Slip Joint x 1-1/2" FIP, Cast Brass, Chrome, 1/Box	BI	1	5	\$67.07
240-08948R104	L.A. Trap, 1-1/2" Slip Joint x 2" FIP, Cast Brass, Rough Brass, 1/Box	BI	1	5	\$114.55

**P-Traps (Cont)**

**Regulation**

Item Number	Item Description	Pkg Type	Min Qty	Case Qty	Price
<b>WITH CLEANOUT</b>					
240-09648R104	L.A. Trap, 1-1/2" Slip Joint x 1-1/2" FIP, Cast Brass, Rough Brass, 1/Box	BI	1	5	\$58.39
240-09847C04	N.Y. Trap, 1-1/4" Slip Joint x 1-1/2" FIP, Cast Brass, Chrome, 1/Box	BI	1	5	\$68.32
240-09847R104	N.Y. Trap, 1-1/4" Slip Joint x 1-1/2" FIP, Cast Brass, Rough Brass, 1/Box	BI	1	5	\$49.69
240-09848C04	L.A. Trap, 1-1/4" Slip Joint x 1-1/2" FIP, Cast Brass, Chrome, 1/Box	BI	1	5	\$72.74
240-09947C04	N.Y. Trap, 1-1/2" Slip Joint x 2" FIP, Cast Brass, Chrome, 1/Box	BI	1	5	\$74.86
240-09947R104	N.Y. Trap 1-1/2" Slip Joint x 2" FIP, Cast Brass, Rough Brass, 1/Box	BI	1	5	\$54.25
240-09988R104	L.A. Trap, 1-1/2" Slip Joint x 2" Sweat, Cast Brass, Rough Brass, 1/Box	BI	1	5	\$101.56



240-09847R104

**P-Traps**

**Utility Traps**

Item Number	Item Description	Pkg Type	Min Qty	Case Qty	Price
<b>UTILITY P-TRAPS</b>					
240-19875C04	Milwaukee Trap, 1-1/4" Slip Joint x 1-1/2" MIP, 17ga, Chrome, 1/Box	BI	1	25	\$57.57
<b>WITH CLEANOUT</b>					
240-20825C04	Milwaukee Trap, 1-1/4" Slip Joint x 1-1/2" MIP, 20ga, Chrome, 1/Box	BI	1	25	\$54.27
240-20835C04	Milwaukee Trap, 1-1/4" Slip Joint x 1-1/2" MIP, 17ga, Chrome, 1/Box	BI	1	25	\$61.26



240-19875C04



240-20825C04

**P-Traps**

**Adjustable Sink Trap**

Item Number	Item Description	Pkg Type	Min Qty	Case Qty	Price
240-2267C04	Swivel Sink Trap, 1-1/2" Slip Joint x 1-1/2" FIP, 17ga, Chrome, 1/Box	BI	1	25	\$36.25
240-22836C04	Washington Swivel Sink Trap, 1-1/4" Slip Joint x 1-1/2" FIP, 20ga, Chrome, 1/Box	BI	1	25	\$32.92
240-22873C04	Swivel Sink Trap, 1-1/4" Slip Joint X 1-1/2" PVC With Cover, 17ga, Chrome 1/Box	BI	1	10	\$48.03
240-2287C04	L.A. Swivel Sink Trap, 1-1/4" Slip Joint x 1-1/2" FIP, 17ga, Chrome, 1/Box	BI	1	25	\$60.51



240-2267C04

Supply

Drainage

Support

Specialties

Appendix

Supply

Drainage

Support

Specialties

Appendix



240-9394R104

**P-Traps**

**Swing Tee**

Item Number	Item Description	Pkg Type	Min Qty	Case Qty	Price
240-9394R104	1-1/2" Slip Joint × 1-1/2" Slip Joint × 2" FIP w/ Cleanout, Rough Cast Brass, 1/Box	BI	1	15	\$85.49

**P-Traps**

**Low-Seal Bath Trap**



240-9464R104

Item Number	Item Description	Pkg Type	Min Qty	Case Qty	Price
240-9464R104	1-1/2" FIP × 1-1/2" FIP, Rough Cast Brass, 1/Box	BI	1	25	\$32.91

**P-Traps**

**Repair P-Trap**



240-1052C04

Item Number	Item Description	Pkg Type	Min Qty	Case Qty	Price
240-1052C04	1-1/4", 20ga, Chrome, 1/Box	BI	1	25	\$34.40
240-1062C04	1-1/2", 20ga, Chrome, 1/Box	BI	1	25	\$39.26



**S-Traps**

Item Number	Item Description	Pkg Type	Min Qty	Case Qty	Price
<b>WITH SHALLOW ESCUTCHEON</b>					
240-1151C04	1-1/4", 22ga, Chrome, 1/Box	Bl	1	12	\$44.28
240-1152C04	1-1/4", 20ga, Chrome, 1/Box	Bl	1	12	\$46.57
240-1153C04	1-1/4", 17ga, Chrome, 1/Box	Bl	1	12	\$53.47
240-1161C04	1-1/2", 22ga, Chrome, 1/Box	Bl	1	12	\$48.58
240-1162C04	1-1/2", 20ga, Chrome, 1/Box	Bl	1	12	\$51.41
240-1163C04	1-1/2", 17ga, Chrome, 1/Box	Bl	1	12	\$59.93
<b>WITH CLEANOUT &amp; SHALLOW ESCUTCHEON</b>					
240-1453C04	1-1/4", 17ga, Chrome, 1/Box	Bl	1	12	\$66.33
240-1463C04	1-1/2", 17ga, Chrome, 1/Box	Bl	1	12	\$73.79
<b>DEEP BELL ESCUTCHEON</b>					
240-12531C04	1-1/4" w/ Brass Nuts, 17ga, Chrome, 1/Box	Bl	1	12	\$55.18
240-12631C04	1-1/2" w/ Brass Nuts, 17ga, Chrome, 1/Box	Bl	1	12	\$60.94
<b>DEEP BOX ESCUTCHEON</b>					
240-1352C04	1-1/4", 20ga, Chrome, 1/Box	Bl	1	12	\$46.51
240-13531C04	1-1/4" w/ Brass Nuts, 17ga, Chrome, 1/Box	Bl	1	12	\$57.24
240-1353C04	1-1/4", 17ga, Chrome, 1/Box	Bl	1	12	\$51.37
240-1362C04	1-1/2", 20ga, Chrome, 1/Box	Bl	1	12	\$50.35
240-13631C04	1-1/2" w/ Brass Nuts, 17ga, Chrome, 1/Box	Bl	1	12	\$60.94
<b>WASHING MACHINE TRAPS</b>					
240-1861C04	1-1/2", 22ga, Chrome, 1/Box	Bl	1	12	\$63.35



240-1151C04



240-1453C04



240-12531C04



240-13531C04



240-1861C04

**Trap Accessories**

Item Number	Item Description	Pkg Type	Min Qty	Case Qty	Price
<b>J-BENDS FOR P-TRAPS &amp; S-TRAPS</b>					
240-1551C12	1-1/4", 22ga, Chrome, 1/Box	Bl	1	12	\$17.27
240-1552C04	1-1/4", 20ga, Chrome, 1/Box	Bl	1	25	\$19.03
240-1553C04	1-1/4", 17ga, Chrome, 1/Box	Bl	1	25	\$23.51
240-1561C01	1-1/2", 22ga, Chrome, 1/Box	Bl	1	12	\$20.27
240-1562C04	1-1/2", 20ga, Chrome, 1/Box	Bl	1	25	\$22.46
240-1563C04	1-1/2", 17ga, Chrome, 1/Box	Bl	1	25	\$24.63



240-1551C12

Supply

Drainage

Support

Specialties

Appendix

Trap Accessories (Cont)

Item Number	Item Description	Pkg Type	Min Qty	Case Qty	Price
<b>J-BENDS FOR S-TRAPS</b>					
240-1661C04	1-1/2", 22ga, Chrome, 1/Box	BI	1	25	\$17.38
240-1662C04	1-1/2", 20ga, Chrome, 1/Box	BI	1	25	\$22.17
240-1663C04	1-1/2", 17ga, Chrome, 1/Box	BI	1	25	\$24.99
<b>LOW-INLET J-BENDS</b>					
240-2163C04	1-1/2" Low-Inlet, 17ga, Chrome, 1/Box	BI	1	25	\$24.60
<b>WALL BENDS</b>					
240-175107C24	1-1/4" x 7", 22ga, Chrome, 1/Bag	BI	1	24	\$10.78
240-176107C24	1-1/2" x 7", 22ga, Chrome, 1/Bag	BI	1	24	\$12.39
240-176212C24	1-1/2" x 12", 20ga, Chrome, 1/Bag	BI	1	24	\$18.79
240-176307C24	1-1/2" x 7", 17ga, Chrome, 1/Bag	BI	1	24	\$16.38
<b>COVER TUBE - WIDE BELL</b>					
240-98720625	2" x 6", Chrome, 1/Bag	BI	1	100	\$18.03

Supply

Drainage

Support

Specialties

Appendix



240-1661C04



240-2163C04



240-175107C24



240-98720625



240-276116C04



240-286116C04

End Outlets

· End Outlets supplied with baffle tee

Item Number	Item Description	Pkg Type	Min Qty	Case Qty	Price
<b>SLIP JOINT</b>					
240-276116C04	1-1/2" x 16", 22ga, Chrome, 1/Box	BI	1	25	\$52.15
240-276121C04	1-1/2" x 21", 22ga, Chrome, 1/Box	BI	1	25	\$60.17
240-276216C04	1-1/2" x 16", 20ga, Chrome, 1/Box	BI	1	25	\$56.31
240-276221C04	1-1/2" x 21", 20ga, Chrome, 1/Box	BI	1	25	\$64.67
240-276316C04	1-1/2" x 16", 17ga, Chrome, 1/Box	BI	1	25	\$61.93
240-276321C04	1-1/2" x 21", 17ga, Chrome, 1/Box	BI	1	25	\$71.36
<b>DIRECT CONNECT</b>					
240-286116C04	1-1/2" x 16", 22ga, Chrome, 1/Box	BI	1	25	\$54.52
240-286216C04	1-1/2" x 16", 20ga, Chrome, 1/Box	BI	1	25	\$60.21
240-286316C04	1-1/2" x 16" w/ Brass Nuts, 17ga, Chrome, 1/Box	BI	1	25	\$67.05

**Center Outlets**

· Center Outlets supplied with baffle tee

Item Number	Item Description	Pkg Type	Min Qty	Case Qty	Price
<b>SLIP JOINT</b>					
240-306116C04	1-1/2" × 16", 22ga, Chrome, 1/Box	Bl	1	25	\$53.04
240-306121C04	1-1/2" × 21", 22ga, Chrome, 1/Box	Bl	1	25	\$61.05
240-3062161C04	1-1/2" × 21", 20ga, Chrome, 1/Box	Bl	1	25	\$69.77
240-306216C04	1-1/2" × 16", 20ga, Chrome, 1/Box	Bl	1	25	\$61.82
240-3063161C04	1-1/2" × 16" w/ Brass Nuts, 17ga, Chrome, 1/Box	Bl	1	25	\$67.71
<b>DIRECT CONNECT</b>					
240-316116C04	1-1/2" × 16", 22ga, Chrome, 1/Box	Bl	1	25	\$56.41
240-316216C04	1-1/2" × 16", 20ga, Chrome, 1/Box	Bl	1	25	\$62.22
240-316316C04	1-1/2" × 16", 17ga, Chrome, 1/Box	Bl	1	25	\$67.71

**Disposer Waste**

Item Number	Item Description	Pkg Type	Min Qty	Case Qty	Price
240-336213C04	1-1/2" × 13", 20ga, w/ ISE® Gasket, Chrome, 1/Box	Bl	1	25	\$63.58
240-336313C04	1-1/2" × 13", 17ga, w/ ISE® Gasket, Chrome, 1/Box	Bl	1	25	\$71.53

**Sink Tailpieces**

Item Number	Item Description	Pkg Type	Min Qty	Case Qty	Price
<b>REDUCING FLANGED</b>					
240-405104C50	1-1/2" × 1-1/4" × 4", 22ga, Chrome, 1/Bag	Bl	1	50	\$7.25
240-405106C50	1-1/2" × 1-1/4" × 6", 22ga, Chrome, 1/Bag	Bl	1	50	\$8.32
240-405108C25	1-1/2" × 1-1/4" × 8", 22ga, Chrome, 1/Bag	Bl	1	25	\$10.75
240-405112C25	1-1/2" × 1-1/4" × 12", 22ga, Chrome, 1/Bag	Bl	1	25	\$14.78



240-306116C04



240-316116C04



240-336213C04



240-405104C50

Supply

Drainage

Support

Specialties

Appendix

**Sink Tailpieces (Cont)**

Item Number	Item Description	Pkg Type	Min Qty	Case Qty	Price
<b>SINGLE FLANGED</b>					
240-406104C50	1-1/2" x 4", 22ga, Chrome, 1/Bag	BI	1	50	\$6.84
240-406106C50	1-1/2" x 6", 22ga, Chrome, 1/Bag	BI	1	50	\$7.73
240-406106R150	1-1/2" x 6", 22ga, Rough Brass, 1/Bag	BI	1	50	\$8.67
240-406108C25	1-1/2" x 8", 22ga, Chrome, 1/Bag	BI	1	25	\$11.41
240-406108R125	1-1/2" x 8", 22ga, Rough Brass, 1/Bag	BI	1	25	\$13.33
240-406112C25	1-1/2" x 12", 22ga, Chrome, 1/Bag	BI	1	25	\$15.09
240-406112R125	1-1/2" x 12", 22ga, Rough Brass, 1/Bag	BI	1	25	\$14.18
240-406118R125	1-1/2" x 18", 22ga, Rough Brass, 1/Bag	BI	1	25	\$21.69
240-406124R125	1-1/2" x 24", 22ga, Rough Brass, 1/Bag	BI	1	25	\$28.97
240-406204C50	1-1/2" x 4", 20ga, Chrome, 1/Bag	BI	1	50	\$7.99
240-406206C50	1-1/2" x 6", 20ga, Chrome, 1/Bag	BI	1	50	\$8.72
240-406206R150	1-1/2" x 6", 20ga, Rough Brass, 1/Bag	BI	1	50	\$7.48
240-406208C25	1-1/2" x 8", 20ga, Chrome, 1/Bag	BI	1	25	\$11.09
240-406212C25	1-1/2" x 12", 20ga, Chrome, 1/Bag	BI	1	25	\$18.00
240-406212R125	1-1/2" x 12", 20ga, Rough Brass, 1/Bag	BI	1	25	\$13.85
240-406306C50	1-1/2" x 6", 17ga, Chrome, 1/Bag	BI	1	50	\$12.27
240-406308C25	1-1/2" x 8", 17ga, Chrome, 1/Bag	BI	1	25	\$16.30
240-406308R125	1-1/2" x 8", 17ga, Rough Brass, 1/Bag	BI	1	25	\$14.48
240-406312C25	1-1/2" x 12", 17ga, Chrome, 1/Bag	BI	1	25	\$19.46
240-406312R125	1-1/2" x 12", 17ga, Rough Brass, 1/Bag	BI	1	25	\$16.45
<b>DOUBLE FLANGED</b>					
240-416116C25	1-1/2" x 16", 22ga, Chrome, 1/Bag	BI	1	25	\$20.86
240-416216C25	1-1/2" x 16", 20ga, Chrome, 1/Bag	BI	1	25	\$28.69
240-416316C25	1-1/2" x 16", 17ga, Chrome, 1/Bag	BI	1	25	\$34.53



Supply

Drainage

Support

Specialties

Appendix

**Extensions**

Item Number	Item Description	Pkg Type	Min Qty	Case Qty	Price
<b>SLIP</b>					
240-455106C32	1-1/4" x 6", 22ga, Chrome, 1/Bag	Bl	1	32	\$11.07
240-455108C16	1-1/4" x 8", 22ga, Chrome, 1/Bag	Bl	1	16	\$12.65
240-455112C16	1-1/4" x 12", 22ga, Chrome, 1/Bag	Bl	1	16	\$15.97
240-455112R116	1-1/4" x 12", 22ga, Rough Brass, 1/Bag	Bl	1	16	\$11.51
240-455206C32	1-1/4" x 6", 20ga, Chrome, 1/Bag	Bl	1	32	\$14.77
240-455208C16	1-1/4" x 8", 20ga, Chrome, 1/Bag	Bl	1	16	\$19.25
240-455212C16	1-1/4" x 12", 20ga, Chrome, 1/Bag	Bl	1	16	\$22.51
240-455306C32	1-1/4" x 6", 17ga, Chrome, 1/Bag	Bl	1	32	\$16.97
240-455308C16	1-1/4" x 8", 17ga, Chrome, 1/Bag	Bl	1	16	\$19.05
240-455312C16	1-1/4" x 12", 17ga, Chrome, 1/Bag	Bl	1	16	\$25.23
240-456106C32	1-1/2" x 6", 22ga, Chrome, 1/Bag	Bl	1	32	\$12.65
240-456108C16	1-1/2" x 8", 22ga, Chrome, 1/Bag	Bl	1	16	\$14.21
240-4561106C32	1-1/2" x 6" w/ Brass Nuts, 22ga, Chrome, 1/Bag	Bl	1	32	\$14.80
240-4561112C16	1-1/2" x 12" w/ Brass Nuts, 22ga, Chrome, 1/Bag	Bl	1	16	\$19.05
240-456112C16	1-1/2" x 12", 22ga, Chrome, 1/Bag	Bl	1	16	\$17.96
240-456112R106	1-1/2" x 12", 22ga, Rough Brass, 1/Bag	Bl	1	16	\$16.64
240-456206C16	1-1/2" x 6", 20ga, Chrome, 1/Bag	Bl	1	16	\$14.37
240-456208C16	1-1/2" x 8", 20ga, Chrome, 1/Bag	Bl	1	16	\$16.35
240-456212C16	1-1/2" x 12", 20ga, Chrome, 1/Bag	Bl	1	16	\$23.98
240-456306C32	1-1/2" x 6", 17ga, Chrome, 1/Bag	Bl	1	32	\$15.84
240-456308C16	1-1/2" x 8", 17ga, Chrome, 1/Bag	Bl	1	16	\$19.01
240-4563121C16	1-1/2" x 12" w/ Brass Nuts, 17ga, Chrome, 1/Bag	Bl	1	16	\$24.33
240-4563121R116	1-1/2" x 12" w/ Brass Nuts, 17ga, Rough Brass, 1/Bag	Bl	1	16	\$22.70
240-456312C16	1-1/2" x 12", 17ga, Chrome, 1/Bag	Bl	1	16	\$24.33
<b>DOUBLE SLIP</b>					
240-465115C16	1-1/4" x 16", 22ga, Chrome, 1/Bag	Bl	1	16	\$21.21
240-466116C16	1-1/2" x 16", 22ga, Chrome, 1/Bag	Bl	1	16	\$23.65
240-466216C16	1-1/2" x 16", 20ga, Chrome, 1/Bag	Bl	1	16	\$35.52
<b>SOLDER JOINT</b>					
240-475106C50	1-1/4" x 6", 22ga, Chrome, 1/Bag	Bl	1	50	\$9.17
240-475108C25	1-1/4" x 8", 22ga, Chrome, 1/Bag	Bl	1	25	\$11.34
240-475112C25	1-1/4" x 12", 22ga, Chrome, 1/Bag	Bl	1	25	\$15.98
240-476106C01	1-1/2" x 6", 22ga, Chrome, 1/Bag	Bl	1	25	\$13.55
240-476108C25	1-1/2" x 8", 22ga, Chrome, 1/Bag	Bl	1	25	\$15.98
240-476112C25	1-1/2" x 12", 22ga, Chrome, 1/Bag	Bl	1	25	\$20.15
240-476212C25	1-1/2" x 12", 20ga, Chrome, 1/Bag	Bl	1	25	\$23.96



Supply

Drainage

Support

Specialties

Appendix



200-064



206-066

## Branch Tailpieces

### LongBranch™ Dishwasher Tailpieces

- Downward inlet eliminates splash-up
- Long 1/2" nominal copper branch provides work space for easy sweat or hose clamp connection
- Quality copper and brass construction. Made in the USA

#### Related Products

Trap-Ease™ Primer Tailpiece p 162

Item Number	Item Description	Pkg Type	Min Qty	Case Qty	Price
<b>DOMESTIC - 1/2" DIRECT CONNECT</b>					
200-062	1-1/2" x 6" x 1/2" Branch w/ Die Cast Zinc Nut, 22ga, Rough Brass	B	25	25	\$14.50
200-064	1-1/2" x 6" x 1/2" Branch w/ Solid Brass Nut, 22ga, Rough Brass	B	25	25	\$15.35
200-066	1-1/2" x 6" x 1/2" Branch w/ Solid Brass Nut, 22ga, Chrome	B	25	25	\$19.51
200-082	1-1/2" x 8" x 1/2" Branch w/ Die Cast Zinc Nut, 22ga, Rough Brass	B	25	25	\$15.32
200-084	1-1/2" x 8" x 1/2" Branch w/ Solid Brass Nut, 22ga, Rough Brass	B	25	25	\$18.05
200-122	1-1/2" x 12" x 1/2" Branch w/ Die Cast Zinc Nut, 22ga, Rough Brass	B	25	25	\$20.20
200-124	1-1/2" x 12" x 1/2" Branch w/ Solid Brass Nut, 22ga, Domestic, Rough Brass	B	25	25	\$21.03
<b>DOMESTIC - 1/2" SLIP JOINT</b>					
206-064	1-1/2" x 6" x 1/2" Branch w/ Solid Brass Nut, 22ga, Rough Brass	B	25	25	\$20.66
206-066	1-1/2" x 6" x 1/2" Branch w/ Solid Brass Nut, 22ga, Chrome	B	25	25	\$26.66
206-084	1-1/2" x 8" x 1/2" Branch w/ Solid Brass Nut, 22ga, Rough Brass	B	25	25	\$24.06

## Branch Tailpieces

### Dishwasher



210-064



216-086

Item Number	Item Description	Pkg Type	Min Qty	Case Qty	Price
<b>DOMESTIC - DIRECT CONNECT</b>					
210-064	1-1/2" x 6" x 3/4" Branch w/ Solid Brass Nut, 22ga, Rough Brass	B	25	25	\$15.33
210-066	1-1/2" x 6" x 3/4" Branch w/ Solid Brass Nut, 22ga, Chrome	B	25	25	\$20.27
210-084	1-1/2" x 8" x 3/4" Branch w/ Solid Brass Nut, 22ga, Rough Brass	B	25	25	\$17.13
210-086	1-1/2" x 8" x 3/4" Branch w/ Solid Brass Nut, 22ga, Chrome	B	25	25	\$19.69
210-122	1-1/2" x 12" x 3/4" Branch w/ Die Cast Zinc Nut, 22ga, Rough Brass	B	25	25	\$21.84
<b>DOMESTIC - SLIP JOINT</b>					
216-084	1-1/2" x 8" x 3/4" Branch w/ Solid Brass Nut, 22ga, Rough Brass	B	25	25	\$22.61
216-086	1-1/2" x 8" x 3/4" Branch w/ Solid Brass Nut, 22ga, Chrome	B	25	25	\$24.07

## Branch Tailpieces (Cont)

### Dishwasher

Item Number	Item Description	Pkg Type	Min Qty	Case Qty	Price
<b>IMPORT - DIRECT CONNECT</b>					
207-06325	1-1/2" x 6" x 1/2" Branch w/ Brass Nut, 22ga, Chrome, 1/Bag	B	25	25	\$26.58
207-08325	1-1/2" x 8" x 1/2" Branch w/ Die Cast Zinc Nut, 22ga, Chrome, 1/Bag	BI	25	25	\$20.37
207-08425	1-1/2" X 8" X 1/2" Branch w/ Brass Nut - Chrome	BI	25	25	\$27.73
207-12225	1-1/2" x 12" x 1/2" Branch w/ Die Cast Zinc Nut, 22ga, Rough Brass, 1/Bag	B	25	25	\$15.40
207-12425	1-1/2" x 12" x 1/2" Branch w/ Solid Brass Nut, 17ga, Rough Brass	B	25	25	\$33.27
210-12225	1-1/2" x 12" x 3/4" Branch w/ Die Cast Zinc Nut, 22ga, Rough Brass	B	1	25	\$18.49
210-38625	1-1/2" x 8" x Dual Branch ( 1/2" CTS x 3/4" MHT) w/ Die Cast Zinc Nut, 22ga, Chrome	B	25	25	\$24.28
<b>IMPORT - LONG BRANCH™ DIRECT CONNECT</b>					
200-12225	1-1/2" x 12" x 1/2" Branch w/ Solid Brass Nut, 22ga, Imported, Rough Brass	B	25	25	\$14.44
<b>IMPORT - ALL PURPOSE</b>					
210-28625	1-1/2" x 8" x 3/4" Branch w/ Die Cast Zinc Nut, 22ga, Chrome, 1/Bag	B	25	25	\$26.61



## Branch Tailpieces

### Lavatory

· For condensate drain

Item Number	Item Description	Pkg Type	Min Qty	Case Qty	Price
<b>DOMESTIC - FINE THREAD</b>					
213-060	1-1/4" x 6" x 3/4" Branch, 20ga, Rough Brass	B	25	25	\$18.06
213-068	1-1/4" x 6" x 3/4" Branch, 20ga, Chrome	B	25	25	\$23.52
<b>DOMESTIC - FINE THREAD x FINE THREAD</b>					
213-061	1-1/4" x 6" x 3/4" Branch, 20ga, Rough Brass	B	25	25	\$18.52
<b>DOMESTIC - SLIP JOINT</b>					
215-064	1-1/4" x 6" x 3/4" Branch, 22ga, Rough Brass	B	25	25	\$19.58
215-066	1-1/4" x 6" x 3/4" Branch, 22ga, Chrome	B	25	25	\$25.23





213-069

## Branch Tailpieces

### MajorTee™

· Branch is higher than standard tailpieces - keeps high and out of sight

Item Number	Item Description	Pkg Type	Min Qty	Case Qty	Price
<b>DOMESTIC - FINE THREAD</b>					
213-067	1-1/4" × 6" × 3/4" MIP Branch, Rough Brass	B	25	25	\$23.97
213-069	1-1/4" × 6" × 3/4" Branch, Rough Brass	B	25	25	\$17.63



240-486124C04

## Waste Arms

### Straight Basin

Item Number	Item Description	Pkg Type	Min Qty	Case Qty	Price
240-486124C04	1-1/2" × 24", 22ga, Chrome, 1/Box	BI	1	12	\$31.13



240-606107C01

## Waste Arms

### Waste Bend

Item Number	Item Description	Pkg Type	Min Qty	Case Qty	Price
<b>SLIP JOINT</b>					
240-606107C01	1-1/2" × 7", 22ga, Chrome, 1/Bag	BI	1	25	\$16.19
240-606108R124	1-1/2" × 8", 22ga, Rough Brass, 1/Bag	BI	1	24	\$16.06
240-606111C24	1-1/2" × 11-1/2", 22ga, Chrome, 1/Bag	BI	1	24	\$20.05
240-606111R124	1-1/2" × 11-1/2", 22ga, Rough Brass, 1/Bag	BI	1	24	\$20.48
240-606115C24	1-1/2" × 15", 22ga, Chrome, 1/Bag	BI	1	24	\$25.00
240-606118R124	1-1/2" × 18", 22ga, Rough Brass, 1/Bag	BI	1	24	\$24.29
240-606124R124	1-1/2" × 24", 22ga, Rough Brass, 1/Bag	BI	1	24	\$32.55
240-606136R124	1-1/2" × 36", 22ga, Rough Brass, 1/Bag	BI	1	24	\$39.07
240-606211C24	1-1/2" × 11-1/2", 20ga, Chrome, 1/Bag	BI	1	24	\$29.37
240-606215C24	1-1/2" × 15", 20ga, Chrome, 1/Bag	BI	1	24	\$33.86
240-606224R124	1-1/2" × 24", 20ga, Rough Brass, 1/Bag	BI	1	24	\$43.85
240-6063111C24	1-1/2" × 11-1/2" w/ Brass Nut, 17ga, Chrome, 1/Bag	BI	1	24	\$29.41
240-6063112R124	1-1/2" × 12" w/ Brass Nut, 17ga, Rough Brass, 1/Bag	BI	1	24	\$31.39
240-6063181R124	1-1/2" × 18" w/ Brass Nut, 17ga, Rough Brass, 1/Bag	BI	1	24	\$41.07
240-6063241C24	1-1/2" × 24" w/ Brass Nut, 17ga, Chrome, 1/Bag	BI	1	24	\$60.58
240-6063241R124	1-1/2" × 24" w/ Brass Nut, 17ga, Rough Brass, 1/Bag	BI	1	24	\$52.59
240-606324R124	1-1/2" × 24", 17ga, Rough Brass, 1/Bag	BI	1	24	\$50.12



**Waste Arms (Cont)**

**Waste Bend**

Item Number	Item Description	Pkg Type	Min Qty	Case Qty	Price
<b>DIRECT CONNECT</b>					
240-616107C01	1-1/2" x 7", 22ga, Chrome, 1/Bag	Bl	1	24	\$12.78
240-616111C24	1-1/2" x 11-1/2", 22ga, Chrome, 1/Bag	Bl	1	24	\$18.21
240-616111R124	1-1/2" x 11-1/2", 22ga, Rough Brass, 1/Bag	Bl	1	24	\$15.05
240-616115C24	1-1/2" x 15", 22ga, Chrome, 1/Bag	Bl	1	24	\$21.78
240-616115R124	1-1/2" x 15", 22ga, Rough Brass, 1/Bag	Bl	1	24	\$16.26
240-616124C24	1-1/2" x 24", 22ga, Chrome, 1/Bag	Bl	1	24	\$31.74
240-616124R124	1-1/2" x 24", 22ga, Rough Brass, 1/Bag	Bl	1	24	\$23.03
240-616215C24	1-1/2" x 15", 20ga, Chrome, 1/Bag	Bl	1	24	\$35.53
240-616311C24	1-1/2" x 11", 17ga, Chrome, 1/Bag	Bl	1	24	\$30.36
240-616311R124	1-1/2" x 11-1/2", 17ga, Rough Brass, 1/Bag	Bl	1	24	\$26.53
<b>SLIP JOINT x DIRECT CONNECT</b>					
240-626124R120	1-1/2" x 24", 22ga, Rough Brass, 1/Bag	Bl	1	20	\$28.23
<b>PLAIN END</b>					
240-636312R124	1-1/2" x 12" x 12", 17ga, Rough Brass, 1/Bag	Bl	1	24	\$45.46
240-636316R116	1-1/2" x 16" x 18", 17ga, Rough Brass, 1/Bag	Bl	1	16	\$72.23



240-616107C01



240-626124R120



240-636312R124

**Threaded Tube**

Item Number	Item Description	Pkg Type	Min Qty	Case Qty	Price
<b>THREAD BOTH ENDS</b>					
240-703212C25	1-3/8" x 12", 20ga, Chrome, 1/Bag	Bl	1	25	\$18.68
240-705206C50	1-1/4" x 6", 20ga, Chrome, 1/Bag	Bl	1	50	\$8.46
240-705208C25	1-1/4" x 8", 20ga, Chrome, 1/Bag	Bl	1	25	\$11.40
240-705212C25	1-1/4" x 12", 20ga, Chrome, 1/Bag	Bl	1	25	\$13.66
240-705212R125	1-1/4" x 12", 20ga, Rough Brass, 1/Bag	Bl	1	25	\$12.19
240-705312C25	1-1/4" x 12", 17ga, Chrome, 1/Bag	Bl	1	25	\$20.11
240-705312R125	1-1/4" x 12", 17ga, Rough Brass, 1/Bag	Bl	1	25	\$17.08
240-705318C25	1-1/4" x 18", 17ga, Chrome, 1/Bag	Bl	1	25	\$24.49
240-706206C06	1-1/2" x 6", 20ga, Chrome, 1/Bag	Bl	1	50	\$11.28
240-706208C25	1-1/2" x 8", 20ga, Chrome, 1/Bag	Bl	1	25	\$13.57
240-706212C25	1-1/2" x 12", 20ga, Chrome, 1/Bag	Bl	1	25	\$15.85
240-706212R125	1-1/2" x 12", 20ga, Rough Brass, 1/Bag	Bl	1	25	\$13.40
240-706218R125	1-1/2" x 18", 20ga, Rough Brass, 1/Bag	Bl	1	25	\$20.52
240-706224R125	1-1/2" x 24", 20ga, Rough Brass, 1/Bag	Bl	1	25	\$27.48
240-706312C25	1-1/2" x 12", 17ga, Chrome, 1/Bag	Bl	1	25	\$23.28
240-706312R125	1-1/2" x 12", 17ga, Rough Brass, 1/Bag	Bl	1	25	\$20.08
240-706318R125	1-1/2" x 18", 17ga, Rough Brass, 1/Bag	Bl	1	25	\$25.54
<b>THREAD ONE END</b>					
240-718108C25	1-1/2" x 1-1/4" x 8", 20ga, Chrome	Bl	1	25	\$15.43



240-705206C50



240-718108C25

Supply

Drainage

Support

Specialties

Appendix

**Tubular Fittings**

Item Number	Item Description	Pkg Type	Min Qty	Case Qty	Price
<b>COUPLING</b>					
240-8051C25	1-1/4", 22ga, Chrome, 1/Bag	BI	1	25	\$10.01
240-8061C25	1-1/2", 22ga, Chrome, 1/Bag	BI	1	25	\$12.16
<b>ELBOW (90) - SLIP JOINT</b>					
240-8251C25	1-1/4", 22ga, Chrome, 1/Bag	BI	1	25	\$29.91
240-8261C25	1-1/2", 22ga, Chrome, 1/Bag	BI	1	25	\$26.85
<b>ELBOW (90) - SLIP JOINT × PLAIN END</b>					
240-825106C01	1-1/4" × 6", 22ga, Chrome, 1/Bag	BI	1	24	\$15.43
240-825108C01	1-1/4" × 8", 22ga, Chrome, 1/Bag	BI	1	12	\$18.16
240-825112C01	1-1/4" × 12", 22ga, Chrome, 1/Bag	BI	1	12	\$20.45
240-825112R101	1-1/4" X 12", 22ga, Rough Brass 1/Bag	BI	1	24	\$12.30
240-826112C01	1-1/2" X 12", 22ga, Chrome 1/Bag	BI	1	12	\$17.42
<b>ELBOW (45) - SLIP JOINT</b>					
240-8451C25	1-1/4", 22ga, Chrome, 1/Bag	BI	1	25	\$19.58
240-8461C25	1-1/2", 22ga, Chrome, 1/Bag	BI	1	50	\$20.20
<b>TEE SLIP JOINT</b>					
240-8561R112	1-1/2", Rough Cast Brass, 1/Bag	BI	1	12	\$23.29
240-8564C01	1-1/2", Cast Brass, Chrome, 1/Bag	BI	1	12	\$30.84
<b>TEE - CENTER OUTLET - SLIP JOINT</b>					
240-8664C12	1-1/2", Cast Brass, Chrome, 1/Bag	BI	1	12	\$35.45
<b>TEE - END OUTLET - SLIP JOINT</b>					
240-8764C06	1-1/2", Cast Brass, Chrome, 1/Bag	BI	1	12	\$35.45
<b>TEE - END OUTLET - DIRECT CONNECT</b>					
240-8864C12	1-1/2", Cast Brass, Chrome, 1/Bag	BI	1	12	\$35.78
<b>TEE - DOUBLE OFFSET - SLIP JOINT</b>					
240-9051C50	1-1/4", 22ga, Chrome, 1/Bag	BI	1	50	\$21.91
240-9051R150	1-1/4", 22ga, Rough Brass, 1/Bag	BI	1	50	\$19.22
240-9052C50	1-1/4", 20ga, Chrome, 1/Bag	BI	1	50	\$27.24
240-9061C25	1-1/2", 22ga, Chrome, 1/Bag	BI	1	50	\$23.77
240-9061R150	1-1/2", 22ga, Rough Brass, 1/Bag	BI	1	50	\$20.58
240-9062C50	1-1/2", 20ga, Chrome, 1/Bag	BI	1	50	\$29.72
240-90631C50	1-1/2" w/ Brass Nuts, 17ga, Chrome, 1/Bag	BI	1	50	\$38.09
240-90631R150	1-1/2" w/ Brass Nutss, 17ga, Rough Brass, 1/Bag	BI	1	50	\$32.32



240-8051C25



240-8251C25



240-825112R101



240-8451C25



240-8561R112



240-8664C12

Supply

Drainage

Support

Specialties

Appendix

**Metal Tubular Accessories**

**Nuts & Washers**

Item Number	Item Description	Pkg Type	Min Qty	Case Qty	Price
<b>SLIP NUTS - SOLID BRASS</b>					
980-5	1-1/4", Chrome Plated Brass	B	100	100	\$2.65
980-6	1-1/2", Chrome Plated Brass	B	100	100	\$3.07
980-7	2", Chrome Plated Brass w/ Washer, 1/Bag	Bl	10	10	\$7.27
980-8	1-1/2" x 1-1/4", Chrome Plated Brass	B	100	100	\$3.24
981-5	1-1/4", Rough Brass	B	100	100	\$2.45
981-6	1-1/2", Rough Brass	B	100	100	\$2.76
981-7	2", Rough Brass w/ Washer, 1/Bag	Bl	10	10	\$6.71
981-8	1-1/2" x 1-1/4", Rough Brass	B	50	500	\$3.02
<b>SLIP NUTS - ZINC</b>					
985-5	1-1/4", Chrome Plated Zinc	B	100	100	\$1.31
985-6	1-1/2", Chrome Plated Zinc	B	100	100	\$1.43
985-8	1-1/2" x 1-1/4", Chrome Plated Zinc	B	100	100	\$1.81
986-6	1-1/2", Brass Plated Zinc	B	100	100	\$1.25
<b>SQUARE-CUT SLIP JOINT WASHERS</b>					
995-20320	1-1/4", 25/Bag	B	25	200	\$0.33
995-20330	1-1/2", 25/Bag	B	25	200	\$0.29
995-20335	1-1/2" X 1-1/4", 25/Bag	B	25	200	\$0.31
995-20340	2", 1/Bag	B	25	200	\$0.29
995-5	1-1/4", 100/Bag	B	100	1000	\$0.33
995-6	1-1/2", 100/Bag	B	100	1000	\$0.28
995-8	1-1/2" x 1-1/4", 100/Bag	B	100	1000	\$0.35
<b>CLOTH-INSERTED TAILPIECE WASHERS</b>					
990-20385	1-1/2", 25/Bag	B	25	300	\$0.57
990-7	1-1/2", 100/Bag	B	100	1000	\$0.54
<b>SOFT RED WASHERS - SLIP JOINT</b>					
996-5S	1-1/4" Red, Soft TPV	B	100	1000	\$0.23
996-6S	1-1/2" Red, Soft TPV	B	100	1000	\$0.20
996-8S	1-1/2" x 1-1/4" Red, Soft TPV	B	100	1000	\$0.23
<b>SOFT RED WASHERS - TAILPIECE</b>					
991-6S	1-1/2" Red, Soft TPV	B	100	1000	\$0.29



981-6



985-5



995-20320



990-20385



996-8S

Supply

Drainage

Support

Specialties

Appendix



270-525



274-5



240-996208R116

## Metal Tubular Accessories

### Desanco Fittings & Adapters

· DWV slip joint adapter sweats to copper DWV pipe to make slip joint connections

Item Number	Item Description	Pkg Type	Min Qty	Case Qty	Price
<b>DESANCO FITTINGS</b>					
270-525	1-1/4" OD × 1-1/4" MIP w/ Brass Ferrule & Die Cast Zinc Nut, 1/Bag	B	25	100	\$12.87
270-6	1-1/2" OD × 1-1/2" MIP w/ Brass Ferrule & Brass Nut, 1/Bag	B	25	25	\$13.22
272-5625	1-1/4" OD × 1-1/2" FIP w/ Brass Ferrule & Die Cast Zinc Nut, 1/Bag	B	25	100	\$14.95
272-6	1-1/2" OD × 1-1/2" FIP w/ Brass Ferrule & Brass Nut, 1/Bag	B	25	25	\$13.80
<b>DWV SLIP JOINT ADAPTER</b>					
274-5	1-1/4" FSWT × 1-1/4" NPSM Thread, Brass	B	10	100	\$7.33
274-6	1-1/2" FSWT × 1-1/2" NPSM Thread, Brass	B	10	100	\$7.40
274-7	2" FSWT × 2" NPSM Thread, Brass	B	10	100	\$7.53

## Metal Tubular Accessories

### Sink Funnel

Item Number	Item Description	Pkg Type	Min Qty	Case Qty	Price
240-996208R116	1-1/2" × 8", Rough Brass, 1/Bag	BI	1	50	\$22.14

# Basket Strainers & Sink Drains

**Basket Strainers**

**Lav/Sink Drains**

Sioux Chief offers a wide variety of basket strainers, including popular designs like KwikFit™, Specification™, Champion® BigBoy™, Lok-Spin®, and many others.





**245-16440C04**  
Page 591



**245-16470C04**  
Page 591



**245-12832C04**  
Page 592



**245-16530C04**  
Page 592



**245-16462C04**  
Page 592



**245-13640C04**  
Page 593



**245-12530C04**  
Page 593



**245-52100C04**  
Page 594



**290-20553C04**  
Page 594



**290-20515C04**  
Page 594



**290-20630C04**  
Page 595



**290-20200**  
Page 595

**Basket Strainers**

**KwikFit™**

- Deep drawn 304 stainless steel with rolled threads to specification tolerances
- Fits 3-1/2" to 4" drain openings

**Related Products**

NoPutty™ Gaskets p 625

Item Number	Item Description	Pkg Type	Min Qty	Case Qty	Price
245-16440C04	Cup Style, Spring Post Basket, Stainless Steel w/ Zinc Nuts, Chrome, 1/Box	Bl	1	20	\$13.20



245-16440C04

**Basket Strainers**

**Specification™**

- Heavyweight “cup style” 304 stainless steel strainer with deep cut threads
- Brass knob and stainless steel clip closure basket

Item Number	Item Description	Pkg Type	Min Qty	Case Qty	Price
245-16450C04	Deep Cup Style, Spring Post Basket, Stainless Steel w/ Zinc Nuts, Chrome, 1/Box	Bl	1	20	\$24.70
245-16452C04	Deep Cup Style, Spring Post Basket, Stainless Steel w/ 2 Brass Nuts, Chrome, 1/Box	Bl	1	20	\$33.97



245-16450C04

**Basket Strainers**

**Ball-Lok™**

- 304 stainless steel body with bright stainless steel basket. Chrome-plated brass knob and stem

Item Number	Item Description	Pkg Type	Min Qty	Case Qty	Price
245-16520C04	Cup Style, Snap Post Basket, Stainless Steel, Zinc Nuts, Chrome 1/Box	Bl	1	50	\$21.86
245-16522C04	Cup Style, Snap Post Basket, Stainless Steel w/ 2 Brass Nuts, Chrome, 1/Box	Bl	1	50	\$28.15



245-12732C04

**Basket Strainers**

**BigBoy™**

- Buffed and polished, heavy duty stainless steel with deep cut threads

Item Number	Item Description	Pkg Type	Min Qty	Case Qty	Price
245-16470C04	Back Nut Style, Spring Post Basket, Stainless Steel w/ Zinc Nuts, Chrome, 1/Box	Bl	1	50	\$15.28



245-16471C04

Supply

Drainage

Support

Specialties

Appendix

Supply

Drainage

Support

Specialties

Appendix



245-16540C04

### Basket Strainers

#### Champion®

- Deep cut 14 pitch locknut threads
- Spring steel clip closure with chrome-plated brass knob

Item Number	Item Description	Pkg Type	Min Qty	Case Qty	Price
245-16540C04	Back Nut Style, Spring Post Basket, Stainless Steel w/ Zinc Nuts, Chrome, 1/Box	BI	1	50	\$19.65



245-12832C04

### Basket Strainers

#### ProBrite™

Item Number	Item Description	Pkg Type	Min Qty	Case Qty	Price
245-12832C04	CBX Back Nut Style, Rubber Seal Basket, Cast Brass With 2 Brass Nuts, Bright Chrome 1/Box	BI	1	5	\$37.48
245-16550C04	FPX Back Nut Style, Four Prong Basket, Stainless Steel w/ Zinc Nuts, Bright Chrome, 1/Box	BI	1	50	\$30.87
245-16560C04	SPX Back Nut Style, Stick Post Basket, Stainless Steel w/ Zinc Nuts, Bright Chrome, 1/Box	BI	1	50	\$30.87



245-16530C04

### Basket Strainers

#### Lok-Spin®

- 304 stainless steel body with bright stainless steel basket
- Positive seating metal stopper with chrome-plated knob and brass stem

Item Number	Item Description	Pkg Type	Min Qty	Case Qty	Price
245-16530C04	Back Nut Style, Stainless Steel w/ Zinc Nuts, Chrome, 1/Box	BI	1	24	\$26.06



245-16462C04

### Basket Strainers

#### EezOn™

- Features a special triangular retainer with thumb screws.
- All 304 stainless steel.

Item Number	Item Description	Pkg Type	Min Qty	Case Qty	Price
245-16460C04	Thumbscrew Installation, Spring Post Basket, Stainless Steel w/ Zinc Nut, Chrome, 1/Box	BI	1	50	\$15.51
245-16462C04	Thumbscrew Installation, Spring Post Basket, Stainless Steel w/ Brass Nut, Chrome, 1/Box	BI	1	50	\$16.63



**Basket Strainers**

**SweetHeart™**

- All wearing parts are made of durable stainless steel

Item Number	Item Description	Pkg Type	Min Qty	Case Qty	Price
245-13640C04	Back Nut Style, Fixed Post Basket, Polypro Body & Nuts, Chrome, 1/Box	Bl	1	50	\$9.57



245-13640C04

**Basket Strainers**

**Duo Sink**

- All stainless steel strainer and basket with chrome plated stem
- Deep cut 14 pitch locknut threads

Item Number	Item Description	Pkg Type	Min Qty	Case Qty	Price
245-12930C04	Back Nut Style, Fixed Post Basket, Stainless Steel w/ Zinc Nuts, Chrome, 1/Box	Bl	1	50	\$11.76



245-12930C04

**Basket Strainers**

**SIG Strainer™**

- Designed for commercial installations

Item Number	Item Description	Pkg Type	Min Qty	Case Qty	Price
245-12530C04	"SIG" Snap-In-Grid Flat Sink Strainer, Stainless Steel w/ Zinc Nuts, Chrome, 1/Box	Bl	1	50	\$13.61



245-12530C04

**Basket Strainers**

**Designer Series Double Cup**

Item Number	Item Description	Pkg Type	Min Qty	Case Qty	Price
245-16950B204	Cup Style, Celcon® Biscuit Finish Insert & Basket, 1/Clamshell	Bl	1	5	\$33.75



245-16950B204

Supply

Drainage

Support

Specialties

Appendix

Supply

Drainage

Support

Specialties

Appendix



245-56400C01



245-52100C04



245-96401C01



245-96520C01



290-20553C04



290-20515C04

## Basket Strainers

### Junior™ Bar Sink

· Perfect for bar sinks, mobile homes and travel trailers

Item Number	Item Description	Pkg Type	Min Qty	Case Qty	Price
245-56400C01	3-In-1 Strainer w/ Duplex, Grid And Plug, Stainless Steel w/ Zinc Nuts, For 2-1/2" Opening, Chrome, 1/Bag	BI	25	100	\$10.26
<b>DEEP-CUP BAR SINK</b>					
245-52100C04	Deep Bail Basket, Stainless Steel w/ Zinc Nuts, For 2-1/2" Opening, Chrome, 1/Bag	BI	1	100	\$36.34

## Basket Strainers

### Replacement Baskets

Item Number	Item Description	Pkg Type	Min Qty	Case Qty	Price
245-96401C01	Fit All Drop Post Replacement Basket For Probrite™ CBX, Chrome, 1/Bag	BI	1	50	\$7.66
245-96440C01	Long Spring Post Replacement Basket For Kwik-Fit™, Chrome, 1/Bag	BI	1	25	\$7.66
245-96490C04	Stick Post Replacement Basket For Pro-Brite™ SPX & Duo Basket, Chrome, 1/Bag	BI	1	50	\$7.66
245-96520C01	Snap Post Replacement Basket For Ball-Lok™, Chrome, 1/Bag	BI	1	50	\$11.56
245-96540C01	Short Spring Post Replacement Basket For Big Boy™, Champion®, Specification™ & EezOn™, Chrome, 1/Bag	BI	1	50	\$7.11
245-99649C04	Junior Replacement Basket, Chrome, 1/Box	BI	1	10	\$7.32

## Lav Sink Drains

Item Number	Item Description	Pkg Type	Min Qty	Case Qty	Price
<b>POP-UP</b>					
290-20553C04	Cast Brass Body w/ Overflow, 1-1/4" × 4" 20ga Tailpiece, Chrome, 1/Box	BI	1	50	\$36.16
<b>FIXED GRID</b>					
290-20514C04	1-1/4" × 8" w/ Overflow, Cast Brass Body w/ 17ga Tailpiece And Brass Nut, Chrome, 1/Box	BI	1	25	\$23.38
290-20515C04	Wheelchair Open Grid Strainer, Cast Brass Body w/ 17ga Offset Tailpiece, Overflow, Chrome, 1/Box	BI	1	25	\$43.88

**Lav Sink Drains**

**PO Plug Drain**

· Patent Overflow Plugs (with overflow)

Item Number	Item Description	Pkg Type	Min Qty	Case Qty	Price
<b>METAL - ONE-PIECE WITH OVERFLOW</b>					
290-20630C04	PO Plug Drain (w/ Overflow), 1-1/4" x 5", One Piece w/ Stopper And Chain, Chrome, 1/Box	Bl	1	50	\$31.64
290-20632C04	PO Plug Drain (w/ Overflow), 1-1/4" x 8", One Piece w/ Stopper And Chain, Chrome, 1/Box	Bl	1	50	\$30.26
<b>METAL TWO-PIECE WITH OVERFLOW</b>					
290-206322C04	PO Plug Drain (w/ Overflow), 1-1/4" x 8", Two Piece w/ Stopper And Chain, Chrome, 1/Box	Bl	1	50	\$41.77
290-630223C04	PO Plug Drain (w/ Overflow), 1-1/4" x 5", Two Piece w/ Stopper And Chain, Chrome, 1/Box	Bl	1	50	\$21.59
290-634223C04	PO Plug Drain (w/ Overflow), 1-1/4" x 12", Two Piece w/ Stopper And Chain, Chrome, 1/Box	Bl	1	25	\$31.90
<b>PLASTIC ONE-PIECE WITH OVERFLOW</b>					
290-363020C01	PO Plug Drain (w/ Overflow), 1-1/4" x 5", Polypro w/ Stopper And Chain, Polished Stainless, 1/Bag	Bl	1	25	\$8.99
290-3650501	PO Plug Drain (w/ Overflow), 1-1/4" x 5", ABS w/ Stopper And Chain, Polished Stainless, 1/Bag	Bl	1	50	\$8.99



290-20630C04



290-363020C01

**Lav Sink Drains**

**CO Plug Drain**

· Center Outlet Plugs (without overflow)

Item Number	Item Description	Pkg Type	Min Qty	Case Qty	Price
<b>METAL ONE-PIECE LESS OVERFLOW</b>					
290-20635C04	C.O. Plug Drain (Less Overflow), 1-1/4" x 5", One Piece w/ Stopper And Chain, Chrome, 1/Box	Bl	1	50	\$32.68
<b>PLASTIC ONE-PIECE LESS OVERFLOW</b>					
290-363520C01	CO Plug Drain (Less Overflow), 1-1/4" x 5", Polypro w/ Stopper And Chain, Polished Stainless, 1/Bag	Bl	1	25	\$8.99



290-20635C04

**Lav Sink Drains**

**Industrial Sink Plug**

· All brass industrial sink plug complete as shown with 1" tailpiece and brass stopper

Item Number	Item Description	Pkg Type	Min Qty	Case Qty	Price
290-20200	Sink Plug 1", Rough Brass	Bl	1	10	\$33.88



290-20200

Supply

Drainage

Support

Specialties

Appendix



# **Bath Waste Drains**

**Brass Waste & Overflows**

**Plastic Waste & Overflows**

**Accessories**





**973-2015C04**  
Page 599



**973-2319C04**  
Page 599



**973-3102C04**  
Page 599



**973-3702C04**  
Page 600



**973-3900C04**  
Page 600



**973-0600C04**  
Page 600







**973-5401C04**  
Page 601



**973-6101C01**  
Page 602



**973-9000C01**  
Page 602

 <b>973-0600C04</b> Page 600	 <b>973-5401C04</b> Page 601	 <b>973-6101C01</b> Page 602	 <b>973-9000C01</b> Page 602	

**Brass Waste & Overflows**

**Trip Lever**

Item Number	Item Description	Pkg Type	Min Qty	Case Qty	Price
973-2015C04	17ga w/ Brass Linkage & Drop Cylinder, Chrome, 1/Box	BI	1	10	\$109.00
973-3015C04	20ga w/ Brass Linkage & Drop Cylinder, Chrome, 1/Box	BI	1	16	\$74.43
973-3015PB04	20ga w/ Brass Linkage & Drop Cylinder, Polished Brass, 1/Box	BI	1	16	\$74.43
973-3015SN04	20ga w/ Brass Linkage & Drop Cylinder, Satin Nickel, 1/Box	BI	1	4	\$94.49
<b>ROMAN TUB WASTE &amp; OVERFLOW</b>					
973-3016C04	20ga w/ Brass Linkage & Drop Cylinder w/ 9" Shoe, Chrome, 1/Box	BI	1	3	\$116.88



**Brass Waste & Overflows**

**Ezy Touch®**

· Reemed Tee intended for above-the-floor applications

Item Number	Item Description	Pkg Type	Min Qty	Case Qty	Price
973-2302C04	17ga, Brass Drain Spud & 2-Hole Faceplate, Chrome, 1/Box	BI	1	12	\$114.57
973-3302C04	20ga, Brass Drain Spud & 2-Hole Faceplate, Chrome, 1/Box	BI	1	12	\$90.72
<b>WITH REEMED TEE</b>					
973-2319C04	17ga, Brass Drain Spud & 2-Hole Faceplate, Chrome, 1/Box	BI	1	10	\$112.37



**Brass Waste & Overflows**

**Twist-N-Close™**

Item Number	Item Description	Pkg Type	Min Qty	Case Qty	Price
973-3102C04	20ga, Brass Drain Spud & 2-Hole Faceplate, Chrome, 1/Box	BI	4	16	\$93.58



Supply

Drainage

Support

Specialties

Appendix

Supply

Drainage

Support

Specialties

Appendix



973-3702C04

### Brass Waste & Overflows

#### Chain & Stopper

- 1-1/2" or 1-3/8" drain and overflow for both 1-1/2" or 1-3/8" systems
- Exposed trim is chrome-plated

Item Number	Item Description	Pkg Type	Min Qty	Case Qty	Price
973-3702C04	20ga, Chain, Stopper & 2-Hole Faceplate, Chrome, 1/Box	BI	1	3	\$66.52



973-3900C04

### Brass Waste & Overflows

#### Standing Waste

Item Number	Item Description	Pkg Type	Min Qty	Case Qty	Price
973-3900C04	20ga, 1-1/2" FIP Connection, Chrome, 1/Box	BI	1	10	\$111.90



973-0600C04

### Plastic Waste & Overflows

#### Cable Drive

Item Number	Item Description	Pkg Type	Min Qty	Case Qty	Price
<b>WHITE POLYPROPYLENE</b>					
973-0600C04	Tubular, Chrome Trim, 1/Box	BI	1	3	\$74.47
973-0600SN/RB04	Tubular, Includes Satin Nickel & Oil-Rubbed Bronze Trim, 1/Box	BI	1	3	\$118.02



973-0010C01



973-1010SN04

### Plastic Waste & Overflows

#### Trip Lever

Item Number	Item Description	Pkg Type	Min Qty	Case Qty	Price
<b>WHITE POLY</b>					
973-0010C01	Tubular, Plastic Linkage & Drop Cylinder, Chrome, 1/Bag	BI	8	8	\$22.00
973-0010PB04	Plastic Linkage & Drop Cylinder, White, Polished Brass, 1/Box	BI	4	4	\$46.15
973-0010SN04	Plastic Linkage & Drop Cylinder, White, Satin Nickel, 1/Box	BI	4	4	\$46.15
973-0015C04	Tubular, Brass Linkage, Plastic Drop Cylinder & Chrome Trim, 1/Box	BI	8	8	\$27.27
973-0015RB04	Tubular, Brass Linkage, Plastic Drop Cylinder & Oil-Rubbed Bronze Trim, 1/Box	BI	1	8	\$52.79
<b>BLACK POLY</b>					
973-1010PB04	Tubular, Brass Linkage, Plastic Drop Cylinder & Polished Brass Trim, 1/Box	BI	4	4	\$46.15
973-1010SN04	Tubular, Brass Linkage, Plastic Drop Cylinder & Satin Nickel Trim, 1/Box	BI	4	4	\$46.15



**Plastic Waste & Overflows**

**Ezy Touch®**

Item Number	Item Description	Pkg Type	Min Qty	Case Qty	Price
<b>WHITE POLY</b>					
973-0302C04	Tubular, Brass Drain Spud & 2-Hole Faceplate, Chrome, 1/Box	BI	1	8	\$31.00
973-0402C04	Tubular, Zinc Drain Spud & 2-Hole Faceplate, Chrome, 1/Bag	BI	8	8	\$28.63
<b>WITH PIPE &amp; TEE</b>					
973-6301C04	PVC Full Kit w/ Brass Drain Spud & 1-Hole Faceplate, Chrome, 1/Box	BI	8	8	\$33.06
973-8301C01	ABS Full Kit w/ Brass Drain Spud & 1-Hole Faceplate, Chrome, 1/Bag	BI	1	8	\$33.06
973-8301PB04	ABS Full Kit w/ Brass Drain Spud & 1-Hole Faceplate, Polished Brass, 1/Box	BI	4	4	\$64.89
<b>HALF KIT</b>					
973-5401C04	PVC w/ Zinc Drain Spud & 1-Hole Faceplate, Chrome, 1/Box	BI	1	12	\$22.23
973-7401C04	ABS w/ Zinc Drain Spud & 1-Hole Faceplate, Chrome, 1/Box	BI	1	12	\$26.77



973-0302C04



973-6301C04



973-5401C04

Supply

Drainage

Support

Specialties

Appendix

**Plastic Waste & Overflows**

**Twist-N-Close™**

· Half kits contain a top elbow, shoe elbow and all trim



Item Number	Item Description	Pkg Type	Min Qty	Case Qty	Price
<b>WHITE POLY</b>					
973-0102C04	Tubular, Brass Drain Spud & 2-Hole Faceplate, Chrome, 1/Box	BI	1	12	\$34.93
973-0202C04	Tubular, Zinc Drain Spud & 2-Hole Faceplate, Chrome, 1/Box	BI	8	8	\$26.36
<b>WITH PIPE &amp; TEE</b>					
973-6101C01	PVC Full Kit w/ Brass Drain Spud & 1-Hole Faceplate, Chrome, 1/Bag	BI	8	8	\$33.06
<b>HALF KIT</b>					
973-5201C01	PVC w/ Zinc Drain Spud & 1-Hole Faceplate, Chrome, 1/Bag	BI	8	8	\$22.23
973-5202C04	PVC w/ Zinc Drain Spud & 2-Hole Faceplate, Chrome, 1/Box	BI	8	8	\$23.34
973-7201C01	ABS w/ Zinc Drain Spud & 1-Hole Faceplate, Chrome, 1/Bag	BI	8	8	\$22.23
<b>HALF KIT WITH TEST</b>					
973-5104C01	PVC w/ Brass Drain Spud & 1-Hole Faceplate, Chrome, 1/Bag	BI	1	24	\$26.77

**Bath Waste Accessories**

Item Number	Item Description	Pkg Type	Min Qty	Case Qty	Price
<b>OVERFLOW REPAIR</b>					
973-9000C01	Trip Lever Faceplate (Brass) With Screws, Chrome, 1/Bag	BI	1	25	\$19.41
973-9015R101	Brass Linkage For Trip Lever Waste & Overflow, 1/Bag	BI	6	120	\$6.55
974-60100	Trip Lever Faceplate (Zinc ) With Screws, Chrome, 1/Bag	BI	1	20	\$8.37
974-60101	Tub Faceplate w/ Screw, 1-Hole, Chrome, 1/Bag	BI	1	10	\$7.06
974-60102	Tub Faceplate w/ Screws, 2-Hole, Chrome, 1/Bag	BI	1	12	\$6.11
974-60116	Tub Overflow Sponge Gasket	B	12	120	\$1.51

Supply

Drainage

Support

Specialties

Appendix

**Bath Waste Accessories (Cont)**

Item Number	Item Description	Pkg Type	Min Qty	Case Qty	Price
<b>TUB WASTE REPAIR</b>					
973-9090C04	Heavy Gauge Bath Drain Spud w/ Grid Strainer, Chrome, 1/Bag	Bl	1	1	\$20.62
973-9097C01	Brass Tub Shoe With 1-1/2" OD x 4-5/8" Tube & Chrome Strainer, 1/Bag	Bl	1	20	\$37.41
973-9099C01	Bath Drain Grid Strainer Only w/ Screw, Chrome, 1/Bag	Bl	1	20	\$2.54
973-9100C04	Twist-N-Close™ Drain Assembly In Heavy Gauge Brass Drain Spud, Chrome, 1/Box	Bl	1	12	\$17.97
973-9300C04	Ezy Touch® Drain Assembly In Heavy Gauge Brass Drain Spud, Chrome, 1/Box	Bl	1	12	\$17.97
973-9392C04	Ezy Touch® Replacement Stopper Assembly, Chrome, 1/Bag	Bl	10	200	\$9.63
973-9601	Bathtub Drain Shoe Gasket, 1/Bag	Bl	1	25	\$1.18



973-9090C04



973-9601

Supply

Drainage

Support

Specialties

Appendix



# **Plumbing Specialties**

**Supply Stops & Kits**

**Supply Tubes**

**Lav/Sink Specialties**

**Closet Specialties**

**Tub/Shower Specialties**

# Plumbing Specialties

## Supply Stops & Kits

Straight and angle stop valves with quarter-turn and multi-turn designs. Select items designed in accordance with A112.18.1/CSA B125.1 - 2018 Standard for Plumbing Supply Fittings and ANSI/NSF 14.

## Supply Tubes

Flexible, water-supply connectors for sinks, toilets, dishwashers and other plumbing fixtures.

## Lav/Sink Specialties

Chrome-plated and plastic escutcheons, and other accessories.

## Closet Specialties

Closet bolts, gaskets and toilet repair items.

## Tub/Shower Specialties

Tub spouts, including the innovative SmartSpout™, shower arms and other accessories.

# Supply Stops & Kits

**Quarter-Turn Bar Stock**

**Quarter-Turn Forged Angle Stops**

**Quarter-Turn Forged Straight Stops**

**Multi-Turn Angle Stops**

**Multi-Turn Straight Stops**

**Add-A-Valve Fittings**





**130-G2C1C**  
Page 609

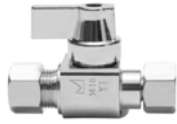

**129-G1RETRO**  
Page 609



**129-G2W1C**  
Page 609



**132-G2C0C04**  
Page 610



**132-G2C1C04**  
Page 610



**131-G2Q1C04**  
Page 611



**132-G2C1CLH04**  
Page 610



**131-G2X1C04**  
Page 611



**131-G0Y3HR101**  
Page 611



**134-G2C0C04**  
Page 612



**134-G2C1C1C04**  
Page 612



**134-G2C1C1CDH04**  
Page 612



**134-G2C1CLK04**  
Page 612



**134-G2S1CE5LK04**  
Page 612



**133-G2C1C1CDHR104**  
Page 613



**133-GZ2M2FR104**  
Page 613



**909-99100201**  
Page 613



**283-S04112C00**  
Page 617



**283-S06112C50**  
Page 617



**281-072**  
Page 618



**289-IMK04**  
Page 618



**637-B23HWP**  
Page 618



**290-20480**  
Page 618



Quarter-Turn Bar Stock

· Chrome-plated with lever handles

Item Number	Item Description	Pkg Type	Min Qty	Case Qty	Price
<b>ANGLE</b>					
130-G1F1C	3/8" FIP × 3/8" OD Comp., Chrome, 1/Bag	BI	24	144	\$11.90
130-G2C0C	5/8" OD Comp. × 1/4" OD Comp., Chrome, 1/Bag	BI	24	144	\$12.86
130-G2C1C	5/8" OD Comp. × 3/8" OD Comp., Chrome, 1/Bag	BI	24	144	\$10.29
130-G2F1C	1/2" FIP × 3/8" OD Comp., Chrome, 1/Bag	BI	24	144	\$11.90
130-G2S1C	1/2" (5/8" OD) SWT. × 3/8" OD Comp., Chrome, 1/Bag	BI	24	144	\$11.28
130-G2V1C	1/2" CPVC × 3/8" OD Comp., Chrome, 1/Bag	BI	24	144	\$13.89
130-G2W0C	1/2" PEX F1960 × 1/4" OD Comp., Chrome, 1/Bag	BI	24	144	\$14.70
130-G2W1C	1/2" PEX F1960 × 3/8" OD Comp., Chrome, 1/Bag	BI	24	144	\$13.01
130-G2X0C	1/2" PEX F1807 × 1/4" OD Comp., Chrome, 1/Bag	BI	24	144	\$12.86
130-G2X1C	1/2" PEX F1807 × 3/8" OD Comp., Chrome, 1/Bag	BI	24	144	\$9.72
<b>STRAIGHT</b>					
129-G1C1C	3/8" OD Comp. × 3/8" OD Comp., Chrome, 1/Bag	BI	24	144	\$13.08
129-G1F1C	3/8" FIP × 3/8" OD Comp., Chrome, 1/Bag	BI	24	144	\$11.90
129-G1RETRO	3/8" Swivel Comp. × 3/8" OD Comp., Chrome, 1/Bag	BI	24	144	\$13.41
129-G2C0C	5/8" OD Comp. × 1/4" OD Comp., Chrome, 1/Bag	BI	24	144	\$12.22
129-G2C1C	5/8" OD Comp. × 3/8" OD Comp., Chrome, 1/Bag	BI	24	144	\$10.11
129-G2F1C	1/2" FIP × 3/8" OD Comp., Chrome, 1/Bag	BI	24	144	\$11.90
129-G2S1C	1/2" SWT. × 3/8" OD Comp., Chrome, 1/Bag	BI	24	144	\$11.03
129-G2V1C	1/2" CPVC × 3/8" OD Comp., Chrome, 1/Bag	BI	24	144	\$13.95
129-G2W0C	1/2" PEX F1960 × 1/4" OD Comp., Chrome, 1/Bag	BI	24	144	\$15.15
129-G2W1C	1/2" PEX F1960 × 3/8" OD Comp., Chrome, 1/Bag	BI	24	144	\$13.05
129-G2X0C	1/2" PEX F1807 × 1/4" OD Comp., Chrome, 1/Bag	BI	24	144	\$12.47
129-G2X1C	1/2" PEX F1807 × 3/8" OD Comp., Chrome, 1/Bag	BI	24	144	\$9.99



130-G2C1C



130-G2W1C

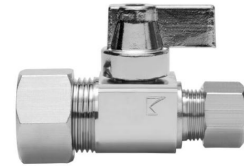

129-G2C1C

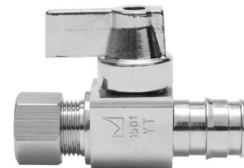

129-G2W1C

Supply

Drainage

Support

Specialties

Appendix

## Quarter-Turn Forged Angle Stops

### KwikStop®

- Quarter Turn on and off
- Chrome-plated with large conventional handles



132-G2C0C04



132-G2F0C01



132-G2X1C04



132-G2C1CLH04

Item Number	Item Description	Pkg Type	Min Qty	Case Qty	Price
<b>STANDARD</b>					
132-G1F1C04	3/8" FIP × 3/8" OD Comp., Chrome, 1/Box	BI	20	240	\$10.92
132-G1Q1C04	3/8" PDQ (1/2" OD Push Fit) × 3/8" OD Comp., Chrome, 1/Box	BI	1	32	\$12.53
132-G2C0C04	5/8" OD Comp. × 1/4" OD Comp., Chrome, 1/Box	BI	20	240	\$13.99
132-G2C1C04	5/8" OD Comp. × 3/8" OD Comp., Chrome, 1/Box	BI	20	240	\$11.02
132-G2C1C09	5/8" OD Comp. × 3/8" OD Comp. w/ PEX Insert, Chrome, 1/Bag	BI	10	50	\$12.24
132-G2C1CN104	5/8" OD Comp. × 3/8" OD Comp. Less 3/8" Comp. Nut, Chrome, 1/Box	BI	20	240	\$10.47
132-G2C2C04	5/8" OD Comp. × 1/2" OD Comp., Chrome, 1/Box	BI	20	240	\$13.96
132-G2C2M01	5/8" OD Comp. × 1/2" MIP (7/16" OD), Chrome, 1/Bag	BI	1	30	\$16.62
132-G2F0C01	1/2" FIP × 1/4" OD Comp., Chrome, 1/Bag	BI	1	30	\$13.56
132-G2F1C04	1/2" FIP × 3/8" OD Comp., Chrome, 1/Box	BI	20	240	\$12.24
132-G2F2C04	1/2" FIP × 1/2" OD Comp., Chrome, 1/Box	BI	20	240	\$17.49
132-G2F2M01	1/2" FIP × 1/2" MIP (7/16" OD), Chrome, 1/Bag	BI	5	30	\$14.69
132-G2Q1C04	1/2" PDQ (5/8" OD Push Fit) × 3/8" OD Comp., Chrome, 1/Box	BI	1	32	\$12.24
132-G2S1C04	1/2" SWT. × 3/8" OD Comp., Chrome, 1/Box	BI	20	240	\$11.60
132-G2S1CE504	1/2" SWT. × 3/8" OD Comp. w/ 5" Extension & Escutcheon, Chrome, 1/Box	BI	10	120	\$15.10
132-G2V1C04	1/2" CPVC × 3/8" OD Comp., Chrome, 1/Box	BI	20	120	\$14.36
132-G2X1C04	1/2" PEX F1807 × 3/8" OD Comp., Chrome, 1/Box	BI	5	30	\$10.47
<b>DUAL-OUTLET</b>					
132-G2C1C0C01	5/8" OD Comp. × 3/8" OD Comp. × 1/4" OD Comp., Chrome, 1/Bag	BI	5	30	\$17.05
132-G2C1C1C04	5/8" OD Comp. × 3/8" OD Comp. × 3/8" OD Comp., Chrome, 1/Box	BI	20	240	\$15.72
132-G2F1C0C01	1/2" FIP × 3/8" OD Comp. × 1/4" OD Comp., Chrome, 1/Bag	BI	5	30	\$16.62
132-G2F1C1C04	1/2" FIP × 3/8" OD Comp. × 3/8" OD Comp., Chrome, 1/Box	BI	20	240	\$16.62
648QGD220A	1/2" PDQ (5/8" OD Push Fit) × 3/8" OD Comp. × 3/8" OD Comp., Chrome, 1/Bag	BI	12	12	\$31.42
<b>LOOSE HANDLE</b>					
132-G2C1CLH04	5/8" OD Comp. × 3/8" OD Comp., Chrome, 1/Box	BI	20	240	\$16.62

Supply

Drainage

Support

Specialties

Appendix

## Quarter-Turn Forged Straight Stops

### KwikStop®

- Quarter Turn on and off
- Chrome-plated with large conventional handles

Item Number	Item Description	Pkg Type	Min Qty	Case Qty	Price
131-GOY3HR101	1/4-Turn, 1/4" Swiv. Comp. X 3/4" MHT, Brass, 1/Bag	BI	5	60	\$9.29
131-G1F1C04	3/8" FIP x 3/8" OD Comp., Chrome, 1/Box	BI	20	240	\$11.37
131-G1Q1C04	3/8" PDQ (1/2" OD Push Fit) x 3/8" OD Comp., Chrome, 1/Box	BI	1	32	\$12.53
131-G2C1C04	5/8" OD Comp. x 3/8" OD Comp., Chrome, 1/Box	BI	20	240	\$10.72
131-G2C1C09	5/8" OD Comp. x 3/8" OD Comp. w/ PEX Insert, Chrome, 1/Bag	BI	1	50	\$12.24
131-G2F1C04	1/2" FIP x 3/8" OD Comp., Chrome, 1/Box	BI	20	240	\$10.85
131-G2Q1C04	1/2" PDQ (5/8" OD Push Fit) x 3/8" OD Comp., Chrome, 1/Box	BI	1	32	\$12.24
131-G2S1C04	1/2" SWT. x 3/8" OD Comp., Chrome, 1/Box	BI	20	240	\$10.63
131-G2S1CE504	1/2" SWT. x 3/8" OD Comp. w/ 5" Extension & Escutcheon, Chrome, 1/Box	BI	10	120	\$15.10
131-G2V1C04	1/2" CPVC x 3/8" OD Comp., Chrome, 1/Box	BI	20	120	\$14.82
131-G2X1C04	1/2" PEX F1807 x 3/8" OD Comp., Chrome, 1/Box	BI	1	30	\$10.19
131-G2X2M01	1/2" PEX F1807 X 1/2" MIP, Chrome 1/Bag	BI	5	30	\$8.26
131-G2X2X04	1/2" PEX F1807 x 1/2" PEX F1807, Chrome, 1/Box	BI	20	240	\$10.47
131-GRETRO01	3/8" Swivel Comp. x 3/8" OD Comp., Chrome, 1/Bag	BI	5	30	\$14.52



131-G2C1C04



131-G2X1C04



131-GOY3HR101

Supply

Drainage

Support

Specialties

Appendix

Multi-Turn Angle Stops

· Chrome-plated and rough brass valves

Item Number	Item Description	Pkg Type	Min Qty	Case Qty	Price
<b>STANDARD</b>					
134-G1F1C04	3/8" FIP × 3/8" OD Comp., Chrome, 1/Box	BI	1	50	\$13.34
134-G2C0C04	5/8" OD Comp. × 1/4" OD Comp., Chrome, 1/Box	BI	1	50	\$13.34
134-G2C0CR104	5/8" OD Comp. × 1/4" OD Comp., Rough Brass, 1/Box	BI	1	50	\$13.11
134-G2C1C04	5/8" OD Comp. × 3/8" OD Comp., Chrome, 1/Box	BI	1	50	\$10.95
134-G2C1CE504	5/8" OD Comp. × 3/8" OD Comp. w/ 5" Extension & Escutcheon, Chrome, 1/Box	BI	1	50	\$15.60
134-G2C1CR104	5/8" OD Comp. × 3/8" OD Comp., Rough Brass, 1/Box	BI	1	50	\$10.77
134-G2C2C04	5/8" OD Comp. × 1/2" OD Comp., Chrome, 1/Box	BI	1	50	\$14.86
134-G2C2M04	5/8" OD Comp. × 1/2" MIP (7/16" OD), Chrome, 1/Box	BI	1	50	\$17.05
134-G2F1C04	1/2" FIP × 3/8" OD Comp., Chrome, 1/Box	BI	1	50	\$12.20
134-G2F2C04	1/2" FIP × 1/2" OD Comp., Chrome, 1/Box	BI	1	50	\$21.43
134-G2F2M04	1/2" FIP × 1/2" MIP & (7/16" OD), Chrome, 1/Box	BI	1	50	\$14.86
134-G2S0CR104	1/2" SWT. × 1/4" OD Comp., Rough Brass, 1/Box	BI	1	50	\$19.68
134-G2S1C04	1/2" SWT. × 3/8" OD Comp., Chrome, 1/Box	BI	1	50	\$10.63
134-G2S1CE504	1/2" SWT. × 3/8" OD Comp. w/ 5" Extension & Escutcheon, Chrome, 1/Box	BI	1	50	\$15.17
134-G2S1CR104	1/2" SWT. × 3/8" OD Comp., Rough Brass, 1/Box	BI	1	50	\$10.42
134-G2V1C04	1/2" CPVC × 3/8" OD Comp., Chrome, 1/Box	BI	1	50	\$14.02
134-G2V1CR104	1/2" CPVC × 3/8" OD Comp., Rough Brass, 1/Box	BI	1	50	\$13.81
134-G2X1C04	1/2" PEX F1807 × 3/8" OD Comp., Chrome, 1/Box	BI	1	50	\$9.74
648XG2FA	1/2" F1807 PEX × 3/8" OD Comp	B	5	60	\$10.74
<b>3-WAY</b>					
134-G2C1C1C04	5/8" OD Comp. × 3/8" OD Comp. × 3/8" OD Comp., Chrome, 1/Box	BI	1	30	\$17.44
134-G2C1C1CR104	5/8" OD Comp. × 3/8" OD Comp. × 3/8" OD Comp., Rough Brass, 1/Box	BI	1	30	\$17.20
134-G2F1C1C04	1/2" FIP × 3/8" OD Comp. × 3/8" OD Comp., Chrome, 1/Box	BI	1	30	\$13.99
134-G2F1C1CR104	1/2" FIP × 3/8" OD Comp. × 3/8" OD Comp., Rough Brass, 1/Box	BI	1	30	\$13.81
<b>2-HANDLE</b>					
134-G2C1C0CDHR104	5/8" OD Comp. × 3/8" OD Comp. × 1/4" OD Comp., Rough Brass, 1/Box	BI	1	50	\$26.57
134-G2C1C1CDH04	5/8" OD Comp. × 3/8" OD Comp. × 3/8" OD Comp., Chrome, 1/Box	BI	1	50	\$26.57
134-G2C1C1CDHR104	5/8" OD Comp. × 3/8" OD Comp. × 3/8" OD Comp., Rough Brass, 1/Box	BI	1	50	\$26.42
<b>LOOSE KEY</b>					
134-G2C1CLK04	5/8" OD × 3/8" OD Comp., Chrome, 1/Box	BI	1	50	\$15.79
134-G2F1CLK04	1/2" FIP × 3/8" OD Comp., Chrome, 1/Box	BI	1	50	\$16.37
134-G2F2CLK04	1/2" FIP × 1/2" OD Comp., Chrome, 1/Box	BI	1	50	\$34.38
134-G2S1CE5LK04	1/2" SWT. × 3/8" OD Comp. w/ 5" Extension & Escutcheon, Chrome, 1/Box	BI	1	50	\$21.43
134-G2S1CLK04	1/2" SWT. × 3/8" OD Comp., Chrome, 1/Box	BI	1	50	\$14.73



134-G2C0C04



134-G2X1C04



134-G2V1C04



134-G2C1C1C04



134-G2C1C1CDH04



134-G2C1CLK04

Supply

Drainage

Support

Specialties

Appendix

Multi-Turn Straight Stops

· Chrome-plated and rough brass valves

Item Number	Item Description	Pkg Type	Min Qty	Case Qty	Price
<b>STANDARD</b>					
133-G1F1C04	3/8" FIP x 3/8" OD Comp., Chrome, 1/Box	BI	1	50	\$13.81
133-G2C1C04	5/8" OD Comp. x 3/8" OD Comp., Chrome, 1/Box	BI	1	50	\$13.03
133-G2C1CR104	5/8" OD Comp. x 3/8" OD Comp., Rough Brass, 1/Box	BI	1	50	\$10.62
133-G2F1C04	1/2" FIP x 3/8" OD Comp., Chrome, 1/Box	BI	1	50	\$12.30
133-G2S1C04	1/2" SWT. x 3/8" OD Comp., Chrome, 1/Box	BI	1	50	\$12.92
133-G2S1CE504	1/2" SWT. x 3/8" OD Comp. w/ 5" Extension & Escutcheon, Chrome, 1/Box	BI	1	50	\$15.17
133-G2S1CR104	1/2" SWT. x 3/8" OD Comp., Rough Brass, 1/Box	BI	1	50	\$12.75
133-G2V1C04	1/2" CPVC x 3/8" OD Comp., Chrome, 1/Box	BI	1	50	\$16.18
133-G2V1CR104	1/2" CPVC x 3/8" OD Comp., Rough Brass, 1/Box	BI	1	50	\$16.01
133-G2X1C04	1/2" PEX F1807 x 3/8" OD Comp., Chrome, 1/Box	BI	1	50	\$10.81
<b>2-HANDLE</b>					
133-G2C1C1CDHR104	5/8" OD Comp. x 3/8" OD Comp. x 3/8" OD Comp., Rough Brass, 1/Box	BI	1	50	\$23.24
<b>INTEGRAL SLOT</b>					
133-GZ2M2FR104	1/2" MIP x 1/2" FIP w/ Slotted Stem, Rough Brass, 1/Box	BI	1	20	\$15.60
133-GZ2S2SR104	1/2" FSWT. x 1/2" MSWT. w/ Slotted Stem, Rough Brass, 1/Box	BI	1	50	\$11.80



133-G2X1C04



133-G2C1C1CDHR104



133-GZ2M2FR104

Add-A-Valve Fitting

· Easily adapts one supply stop outlet into two

Item Number	Item Description	Pkg Type	Min Qty	Case Qty	Price
<b>STANDARD COMPRESSION</b>					
907-2120200201	1/2" Swivel Comp. x 1/2" OD Comp. x 1/4" OD Comp., Rough Brass, 1/Bag	BI	5	60	\$19.08
907-221602	1/2" Swivel Comp. x 3/8" OD Comp. x 1/4" OD Comp., Rough Brass, 1/Bag	B	10	120	\$14.41
907-981001	3/8" Swivel Comp. x 3/8" OD Comp. x 3/8" OD Comp., Rough Brass, 1/Bag	BI	5	60	\$13.34
<b>ANDER-LIGN® COMPRESSION</b>					
909-991001	3/8" Swivel Comp. x 3/8" OD Comp. x 3/8" OD Comp., Rough Brass, 1/Bag	BI	5	60	\$11.29
909-99100201	3/8" Swivel Comp. x 3/8" OD Comp. x 1/4" OD Comp., Rough Brass, 1/Bag	BI	5	60	\$10.21



907-981001



909-99100201



# Supply Tubes

**Lav/Sink Supply**

**Toilet Supply**

**Ice Maker Supply & Kits**

**Dishwasher Elbow Connectors**

**Washers & Gaskets**







Lav/Sink Supply

- PEX tubes supplied with plastic ferrules
- Smooth Flexible Supply Tubes

Item Number	Item Description	Pkg Type	Min Qty	Case Qty	Price
<b>COPPER</b>					
283-S04112C00	3/8" OD × 12", Chrome	B	25	100	\$4.90
283-S04112R100	3/8" OD × 12", Unplated	B	25	100	\$4.66
283-S04116C00	3/8" OD × 16", Chrome	B	25	100	\$6.56
283-S04120C00	3/8" OD × 20", Chrome	B	25	100	\$7.56
283-S04120R100	3/8" OD × 20", Unplated	B	25	100	\$7.14
283-S04130C50	3/8" OD × 30", Chrome	B	25	100	\$12.06
283-S04130R150	3/8" OD × 30", Unplated	B	25	100	\$11.47
283-S04136C50	3/8" OD × 36", Chrome	B	25	100	\$13.28
283-S04136R100	3/8" OD × 36", Unplated	B	25	100	\$11.76
<b>COPPER COMPRESSION TUBE EXTENSION</b>					
283-S06112C50	3/8" OD × 12" Comp. × Tube, Chrome	B	25	100	\$8.07
283-S06112R150	3/8" OD × 12" Comp. × Tube, Unplated	B	25	100	\$6.45
283-S06120C50	3/8" OD × 20" Comp. × Tube, Chrome	B	25	100	\$11.42
283-S06120R150	3/8" OD × 20" Comp. × Tube, Unplated	B	25	100	\$8.61
<b>COPPER SOLDER TUBE EXTENSION</b>					
283-S05112R150	3/8" OD × 12" MSWT × FSWT, Unplated	B	50	50	\$3.27
283-S05120R150	3/8" OD × 20" MSWT × FSWT, Unplated	B	50	50	\$5.19
<b>PEX</b>					
285-100	Ferrule, Poly 3/8" For PEX Riser	B	100	10000	\$0.18
285-S0412000	3/8" OD × 20" w/ Nylon Ferrule, PEX	B	100	100	\$1.31
285-S0413000	3/8" OD × 30" w/ Nylon Ferrule, PEX	B	100	100	\$1.79
285-S0413600	3/8" OD × 36" w/ Nylon Ferrule, PEX	B	100	100	\$2.05



283-S04112C00



283-S06112C50



283-S05112R150



285-S0412000

Toilet Supply

- PEX tubes supplied with plastic ferrules
- Smooth Flexible Supply Tubes

Item Number	Item Description	Pkg Type	Min Qty	Case Qty	Price
<b>COPPER</b>					
283-T24112C00	3/8" × 12" w/ Rubber Nose Cone, Chrome	B	25	100	\$7.42
283-T24120C00	3/8" × 20" w/ Rubber Nose Cone, Chrome	B	25	100	\$9.85
283-T25112C00	3/8" × 12" w/ Flat Washer, Chrome	B	25	100	\$6.29
283-T25116C00	3/8" × 16" w/ Flat Washer, Chrome	B	25	100	\$7.15
283-T25120C00	3/8" × 20" w/ Flat Washer, Chrome	B	25	100	\$8.59
<b>PEX</b>					
285-T2411200	3/8" OD × 12" w/ Nylon Ferrule, PEX	B	100	100	\$1.07
285-T2412000	3/8" OD × 20" w/ Nylon Ferrule, PEX	B	100	100	\$1.31
285-100	Ferrule, Poly 3/8" For PEX Riser	B	100	10000	\$0.18



283-T24112C00



285-T2411200

Supply

Drainage

Support

Specialties

Appendix



281-072



901-03020W00501



289-IMK04



637-B23HWP



290-20480

## Ice Maker Supply & Kits

### Related Products

Needle Valves - Saddle Valves p 752

Item Number	Item Description	Pkg Type	Min Qty	Case Qty	Price
<b>BRAIDED STAINLESS</b>					
281-072	Stainless Steel Connector 1/4" x 1/4" x 72", 1/Bag	BI	1	12	\$12.05
<b>POLYETHYLENE</b>					
901-03020W00251	1/4" OD x 17/100" ID (1/25" Wall) 25' Coil	CI	10	10	\$5.38
901-03020W00501	1/4" OD x 17/100" ID (1/25" Wall) 50' Coil	CI	5	5	\$9.84
901-03020W01001	1/4" OD x 17/100" ID (1/25" Wall) 100' Coil	BI	1	1	\$17.90
901-03020W01005	1/4" OD x 17/100" ID (1/25" Wall) 100' Reel	BI	1	1	\$17.90
901-03020W04005	1/4" OD X 17/100" ID (1/25" Wall), 400' Reel	BI	1	1	\$52.37
<b>PEX</b>					
289-IMK04	PEX Quick Connect Kit, 1/Bag	BI	5	5	\$38.92

## Dishwasher Supply & Kits

Item Number	Item Description	Pkg Type	Min Qty	Case Qty	Price
<b>DISHWASHER ELBOW CONNECTOR</b>					
637-B23HWP	3/4" Female Hose Thread x 3/8" OD Comp., Rough Brass, 1/Bag	BI	5	20	\$8.59
637-G23H	3/4" Female Hose Thread x 3/8" OD Comp., Short Radius, Heavy-Duty Hose Nut, Rough Brass, 1/Bag	B	20	20	\$7.49

## Washers & Gaskets

Item Number	Item Description	Pkg Type	Min Qty	Case Qty	Price
290-20480	Deluxe Lavatory Washer 3/8" Tall w/ Brass Friction Ring	B	50	500	\$0.91
290-20482	Deluxe Closet Washer 7/16" Tall w/ Brass Friction Ring	B	50	500	\$0.91
291-30500	3/4" Garden Hose Washer	B	12	240	\$0.35

# **Lav/Sink Specialties**

**Poly Escutcheons**

**Metal Escutcheons**

**Sink/Faucet Repair**

**Dishwasher/Disposal Drain**

**Accessories**





**920-1W**  
Page 621



**926-2**  
Page 621



**910-2**  
Page 622



**923-2326C00**  
Page 623



**923-2322C00**  
Page 623



**923-1612C01**  
Page 624



**290-21104**  
Page 624



**291-30380**  
Page 624



**961-20155**  
Page 625



**242-10**  
Page 625



**905**  
Page 626



**902**  
Page 626



**249**  
Page 627



**290-20180**  
Page 627



**974-95650304**  
Page 627

## Polypropylene Escutcheons

### TrimTite™ Escutcheons

- Corrosion proof and wont scratch tube
- Attractive appliance white color
- 922 Series are 3" Deep with extra wide 4" base

Item Number	Item Description	Pkg Type	Min Qty	Case Qty	Price
<b>SHALLOW CTS</b>					
920-1W	3/8" CTS (1/2" OD), White	B	50	500	\$0.16
920-2W	1/2" CTS (5/8" OD), White	B	25	250	\$0.22
920-2WPK2	1/2" CTS (5/8" OD), White, 2/Bag	Cl	10	10	\$0.95
920-3W	3/4" CTS (7/8" OD), White	B	25	250	\$0.24
920-3WPK2	3/4" CTS (7/8" OD), White, 2/Bag	Cl	10	10	\$0.99
920-4W	1" CTS (1-1/8" OD), White	B	20	100	\$0.51
920-4WPK2	1" CTS (1-1/8" OD), White, 2/Bag	Cl	1	1	\$1.52
<b>SHALLOW IPS</b>					
921-2W	1/2" IPS, White	B	50	500	\$0.24
921-2WPK2	1/2" IPS, White, 2/Bag	Cl	10	10	\$0.99
921-3W	3/4" IPS, White	B	50	500	\$0.26
921-3WPK2	3/4" IPS, White, 2/Bag	Cl	10	10	\$1.02
921-4W	1" IPS, White	B	20	100	\$0.47
921-4WPK2	1" IPS, White, 2/Bag	Cl	10	10	\$1.44
921-6W	1-1/2" IPS, White	B	20	100	\$0.45
921-6WPK2	1-1/2" IPS, White, 1/Bag	Cl	10	10	\$0.95
921-7W	2" IPS, White	B	20	100	\$0.47
921-7WPK2	2" IPS, White, 1/Bag	Cl	10	10	\$0.97
<b>DEEP TUBULAR</b>					
922-5W	1-1/4" OD Tubular, White	B	25	25	\$1.00
922-5WPK2	1-1/4" OD Tubular, White	Cl	10	10	\$1.50
922-6W	1-1/2" OD Tubular, White	B	25	25	\$1.00
922-6WPK2	1-1/2" OD Tubular, White	Cl	10	10	\$1.50



920-1W



921-6W



922-5W

## Polypropylene Escutcheons

### SnapOne™ Escutcheons

- Split for pre-piped jobs
- 100% rust proof

Item Number	Item Description	Pkg Type	Min Qty	Case Qty	Price
<b>CTS</b>					
926-2	1/2" CTS (5/8" OD), Chrome, 1/Bag	Bl	12	120	\$1.38
926-2W	1/2" CTS (5/8" OD), White, 1/Bag	Bl	12	120	\$0.90
926-3	3/4" CTS (7/8" OD), Chrome, 1/Bag	Bl	12	120	\$1.41
926-3W	3/4" CTS (7/8" OD), White, 1/Bag	Bl	12	120	\$0.95
926-4	1" CTS (1-1/8" OD), Chrome, 1/Bag	Bl	12	120	\$1.53
926-4W	1" CTS (1-1/8" OD), White, 1/Bag	Bl	12	120	\$1.11



926-2

## Polypropylene Escutcheons (Cont)

### SnapOne™ Escutcheons



927-2W

Item Number	Item Description	Pkg Type	Min Qty	Case Qty	Price
<b>IPS</b>					
927-2	1/2" IPS, Chrome, 1/Bag	BI	12	120	\$1.38
927-2W	1/2" IPS , White, 1/Bag	BI	12	120	\$0.94
927-3	3/4" IPS, Chrome, 1/Bag	BI	12	120	\$1.51
927-3W	3/4" IPS , White, 1/Bag	BI	12	120	\$0.95
927-4	1" IPS, Chrome, 1/Bag	BI	12	120	\$1.61
927-4W	1" IPS , White, 1/Bag	BI	12	120	\$1.10
927-5	1-1/4" IPS, Chrome, 1/Bag	BI	12	120	\$2.19
927-6	1-1/2" IPS, Chrome, 1/Bag	BI	12	120	\$2.27
927-6W	1-1/2" IPS , White, 1/Bag	BI	12	120	\$1.31
927-7	2" IPS, Chrome, 1/Bag	BI	12	120	\$2.53
927-7W	2" IPS , White, 1/Bag	BI	12	120	\$1.30
927-8W	3" IPS , White, 1/Bag	BI	12	120	\$2.45

## Metal Escutcheons

### Shallow Escutcheons

- Chrome-plated steel
- Sure grip fit



910-2



911-4



923-1036C00

Item Number	Item Description	Pkg Type	Min Qty	Case Qty	Price
<b>SHALLOW CTS</b>					
910-2	1/2" CTS (5/8" OD), Chrome	BI	25	250	\$0.58
910-3	3/4" CTS (7/8" OD), Chrome	BI	25	250	\$0.63
<b>SHALLOW IPS</b>					
911-1	3/8" IPS, Chrome	BI	25	250	\$0.70
911-2	1/2" IPS, Chrome	BI	25	250	\$0.58
911-3	3/4" IPS, Chrome	BI	25	250	\$0.72
911-4	1" IPS, Chrome	BI	25	250	\$0.83
911-6	1-1/2" IPS, Chrome	BI	25	250	\$0.99
911-6D	1-1/2" IPS Deluxe, Chrome, 1/Bag	BI	25	250	\$1.36
911-7	2" IPS, Chrome	BI	25	250	\$1.66
<b>SHALLOW TUBULAR</b>					
923-1036C00	1-1/2" OD Tubular, Chrome	BI	12	120	\$0.77

Supply

Drainage

Support

Specialties

Appendix

**Metal Escutcheons**

**Deep Box**

- Chrome-plated steel
- Sure grip fit

Item Number	Item Description	Pkg Type	Min Qty	Case Qty	Price
<b>IPS</b>					
923-2326C00	1-1/2" IPS, Chrome	BI	5	100	\$2.72
<b>TUBULAR</b>					
923-2335C00	1-1/4" OD Tubular, Chrome	BI	5	100	\$2.49
923-2336C00	1-1/2" OD Tubular, Chrome	BI	5	100	\$2.13



923-2326C00



923-2335C00

**Metal Escutcheons**

**Deep Bell**

- Chrome-plated steel
- Sure grip fit

Item Number	Item Description	Pkg Type	Min Qty	Case Qty	Price
<b>IPS</b>					
923-2321C00	3/8" IPS, Chrome	BI	25	100	\$2.82
923-2322C00	1/2" IPS, Chrome	BI	25	100	\$3.66
<b>TUBULAR</b>					
923-2435C00	1-1/4" OD Tubular × 3" Base, Chrome	BI	25	25	\$2.49
923-2436C00	1-1/2" OD Tubular × 3" Base, Chrome	BI	25	25	\$2.72
<b>CAST BRASS - IPS</b>					
923-2521C04	3/8" IPS, Cast Brass w/ Set Screw, Chrome, 1/Bag	BI	1	200	\$8.84
923-2522C04	1/2" IPS, Cast Brass w/ Set Screw, Chrome, 1/Bag	BI	1	200	\$9.62
923-2525C04	1-1/4" IPS, Cast Brass w/ Set Screw, Chrome, 1/Bag	BI	1	200	\$13.44
923-2526C04	1-1/2" IPS, Cast Brass w/ Set Screw, Chrome, 1/Bag	BI	1	200	\$14.27
923-2527C04	2" IPS, Cast Brass w/ Set Screw, Chrome, 1/Bag	BI	1	200	\$16.39
<b>CAST BRASS - TUBULAR</b>					
923-2536C04	1-1/2" OD Tubular, Cast Brass w/ Set Screw, Chrome, 1/Bag	BI	1	200	\$14.27



923-2322C00



923-2435C00



923-2522C04

Supply

Drainage

Support

Specialties

Appendix

Supply

Drainage

Support

Specialties

Appendix



923-1612C01



923-1625C01



290-21104



291-30380

## Metal Escutcheons

### Hinged Floor & Ceiling Plates

- Chrome-plated steel
- Split for pre-piped jobs

Item Number	Item Description	Pkg Type	Min Qty	Case Qty	Price
<b>CTS</b>					
923-1612C01	1/2" CTS (5/8" OD), Chrome, 1/Bag	BI	12	12	\$2.12
923-1613C01	3/4" CTS (7/8" OD), Chrome, 1/Bag	BI	12	12	\$2.44
923-1614C01	1" CTS (1-1/8" OD), Chrome, 1/Bag	BI	12	120	\$2.49
923-1615C01	1-1/4" CTS (1-3/8" OD), Chrome, 1/Bag	BI	12	12	\$2.83
923-1616C01	1-1/2" CTS (1-5/8" OD), Chrome, 1/Bag	BI	12	12	\$2.83
<b>IPS</b>					
923-1622C01	1/2" IPS, Chrome, 1/Bag	BI	12	12	\$2.05
923-1623C01	3/4" IPS, Chrome, 1/Bag	BI	12	12	\$2.77
923-1624C01	1" IPS, Chrome, 1/Bag	BI	12	12	\$2.27
923-1625C01	1-1/4" IPS, Chrome, 1/Bag	BI	12	12	\$2.83
923-1626C01	1-1/2" IPS, Chrome, 1/Bag	BI	12	12	\$2.32
923-1627C01	2" IPS, Chrome, 1/Bag	BI	12	12	\$3.32

## Sink/Faucet Repair

### Faucet Aerators

- 2.2 GPM maximum
- Chrome-plated brass

Item Number	Item Description	Pkg Type	Min Qty	Case Qty	Price
290-21100	Dual 15/16"-27 Thread Male × 55/64"-27 Thread Female, Non-Slotted, Chrome	BI	6	48	\$3.52
290-21104	Small 13/16"-27 Thread Male, Non-Slotted, Chrome	BI	6	48	\$3.75
290-21110	Aerator Adapter - Dual 15/16"-27 Thread Male × 55/64"-27 Thread Female × 3/4" MHT, Chrome	BI	5	250	\$6.10

## Sink/Faucet Repair

### O-Rings

- 12-Compartment plastic box

Item Number	Item Description	Pkg Type	Min Qty	Case Qty	Price
291-30380	Buna-N O-Rings, 150-Piece Kit	BI	1	10	\$37.07



## Sink/Faucet Repair

### Faucet Hole Covers

Item Number	Item Description	Pkg Type	Min Qty	Case Qty	Price
961-20155	Plastic, 1-3/4" w/ O-Ring And Wing Nut , White	BI	1	25	\$3.89
961-6	Metal, 1-3/4" w/ Toggle Nut, Chrome	B	25	25	\$2.23
961-7	Metal, 2" w/ Wing Nut, Chrome	B	25	25	\$2.76



961-20155

## Sink/Faucet Repair

### NoPutty™ Gaskets

- Replaces plumber's putty, won't dry out, stain or smudge
- Self adhesive eliminates mess
- Creates a tight seal on all finishes & materials
- Fits all standard drain attachments
- Stands up to the toughest commercial cleaners
- Allows you to pre-fab fixtures



290-20320

#### Related Products

Basket Strainers and Sink Drains p 591

Item Number	Item Description	Pkg Type	Min Qty	Case Qty	Price
<b>KITCHEN SINK &amp; SHOWER DRAIN</b>					
290-20320	4-1/4" OD x 3-3/8" ID	B	100	1000	\$1.49
290-20320PK2	4-1/4" OD x 3-3/8" ID, 4/Bag	CI	1	12	\$6.71
<b>KITCHEN HOSE SPRAY</b>					
290-20322	2" OD x 1-1/2" ID	B	100	1000	\$1.15
290-20322PK2	2" OD x 1-1/2" ID, 4/Bag	CI	1	12	\$5.35
<b>BATHUB &amp; BAR SINK</b>					
290-20324	2-3/4" OD x 2" ID	B	100	1000	\$1.15
290-20324PK2	2-3/4" OD x 2" ID, 4/Bag	CI	1	12	\$5.35

## Sink/Faucet Repair

### Kitchen Hose Spray

- Universal coupling connection: 1/8" MIP with 1/8" FIP x 1/4" FIP

Item Number	Item Description	Pkg Type	Min Qty	Case Qty	Price
242-10	Spray Head & Hose Kit w/ Universal Connection, Black, 1/Bag	BI	1	10	\$16.65
242-20	Hose Guide, Plastic w/ Polished Stainless Steel Skirt, Black, 1/Bag	BI	1	100	\$2.72
242-20102	Spray Head & Hose Kit w/ Universal Connection, White, 1/Bag	BI	1	10	\$18.50
242-20116	Hose Guide, Plastic w/ Polished Stainless Steel Skirt, White, 1/Bag	BI	1	25	\$3.68
242-25	Universal Spray Head Only, Black, 1/Bag	BI	1	10	\$8.82



242-10

Supply

Drainage

Support

Specialties

Appendix



905



900-04258N00505



IMG\_0273

## Dishwasher/Disposal Drain

### Drain Hose

- EPDM hose has maximum operating temperature of 225°F
- Vinyl hose has maximum operating temperature of 185°F
- 5/8" connects dishwasher pump to air gap inlet, directly to a 5/8" branch tailpiece or to a disposal tap-in (with a connector kit 902 & 90201)
- 7/8" connects the air gap outlet to branch tailpiece or to a disposal tap-in

Item Number	Item Description	Pkg Type	Min Qty	Case Qty	Price
<b>EPDM HOSE</b>					
900-12256N00101	5/8" ID × 7/8" OD (1/8" Wall) Black 10' Coil	BI	10	5	\$21.25
905	Dishwasher Drain Hose 5/8" ID × 50' Coil, EZ Dispenser Box (Unit of Measure Per Box)	B	1	1	\$108.62
905-PK	Dishwasher Drain Hose 5/8" ID × 50' Coil, EZ Dispenser Box (Unit of Measure Per Foot)	B	50	50	\$2.22
906	Dishwasher Drain Hose 7/8" ID × 50' Coil, EZ Dispenser Box (Unit of Measure Per Box)	B	1	1	\$182.86
906-PK	Dishwasher Drain Hose 7/8" ID × 50' Coil, EZ Dispenser Box (Unit of Measure Per Foot)	B	50	50	\$3.71
<b>BRAIDED VINYL HOSE</b>					
900-04258N00101	Dishwasher Drain Hose 5/8" × 1" OD (3/16" Wall), 10' Coil	BI	10	10	\$22.40
900-04258N00505	Dishwasher Drain Hose 5/8" × 1" OD (3/16" Wall), 50' Reel	BI	1	1	\$93.30
900-04338N00021	7/8" ID × 1-1/4" OD (3/16" Wall) × 2'	BI	12	12	\$5.98
900-04338N00101	Dishwasher Drain Hose 7/8" ID × 1-1/4" OD (3/16" Wall), × 10' Coil	BI	5	5	\$29.86
900-04338N00255	Dishwasher Drain Hose 7/8" ID × 1-1/4" OD (3/16" Wall), × 25' Reel	BI	1	1	\$66.76

## Dishwasher/Disposal Drain

### Dishwasher Adapter

Item Number	Item Description	Pkg Type	Min Qty	Case Qty	Price
902	Black Elastomer Universal Adapter w/ 2 Stainless Worm Clamps, Bagged	BI	50	50	\$4.26
90201	Universal Dishwasher/Disposal Connector w/ 4 Clamps, Bagged	B	5	100	\$3.15

## Dishwasher/Disposal Drain

### Dishwasher Air Gaps

- Uniquely designed inlet tube and inner cup eliminates spitting/dischage action

Item Number	Item Description	Pkg Type	Min Qty	Case Qty	Price
241-20135	Economy Air Gap w/ Poly Cap, 1/2" Inlet And 3/4" Outlet, Chrome, 1/Box	B	1	48	\$4.63
249	Heavy-Duty Air Gap w/ Brass Cap, 1/2" Inlet And 3/4" Outlet, Chrome, 1/Bag	BI	25	25	\$12.77
249-20135	Economy Air Gap w/ Poly Cap, 1/2" Inlet And 3/4" Outlet, Chrome, 1/Box	BI	1	50	\$6.28



249

## Dishwasher/Disposal Drain

### Auto Vent

- For secondary venting only. Each drainage system must have a main vent stack
- To be installed in a readily accesible location with free flow of air, never in a sealed wall cavity.
- Sealing disc of auto vent must be located at least 6" above the top of the trap arm.

Item Number	Item Description	Pkg Type	Min Qty	Case Qty	Price
239	Trap Vent ABS 1-1/2" MPT	B	50	50	\$3.80
239PK2	Trap Vent ABS 1-1/2" MPT, 1/Bag	CI	10	10	\$4.55



239

## Dishwasher/Disposal Drain

### Disposal Drain

Item Number	Item Description	Pkg Type	Min Qty	Case Qty	Price
290-20180	Replacement In-Sink-Erator Disposal Elbow Gasket Only	B	5	25	\$0.93
290-20185	1-1/2" x 7" Disposal Waste Elbow, 1/Bag	BI	1	12	\$4.17



290-20180

## Lav/Sink Accessories

### Lavatory Legs

- Length - 28"

Item Number	Item Description	Pkg Type	Min Qty	Case Qty	Price
974-95650004	Lavatory (China Or Iron) Basin Legs, Chrome, 2/Box	BI	1	12	\$48.76
974-95650304	Lavatory (China Only) Basin Legs, Chrome, 2/Box	BI	1	12	\$47.14



974-95650304



# Closet Specialties

**Closet Bolts**

**Bolt Caps**

**Wedgelt™**

**Closet Bowl Gaskets**

**Tank-to-Bowl Repair**

**Toilet Fill Valves**

**Toilet Flush Valves**

**Tank Handles**

**Miscellaneous**



The PlumbPerfect™ is the original nylon closet bolt - and is Made in the USA.  
Beware of look-alikes, the PlumbPerfect has a tensile strength of over 1,100 lbs. per bolt.



**416-PB**  
Page 631



**425**  
Page 631



**440-2W**  
Page 631

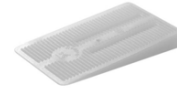

**460-10**  
Page 632



**402-10**  
Page 632



**490-10555**  
Page 633



**490-1080M2KIT**  
Page 634



**490-10465**  
Page 634



**490-11100**  
Page 635



**490-10700**  
Page 636



**490-10108**  
Page 636

**Closet Bolts**

**Solid Brass Bolts**

- Nickel-plated steel nut and zinc-plated washer included

Item Number	Item Description	Pkg Type	Min Qty	Case Qty	Price
410-PB	1/4" × 2-1/4", 2/Bag	BI	50	50	\$2.52
411-PB	1/4" × 3-1/2", 2/Bag	BI	50	50	\$3.34
415-PB	5/16" × 1-3/4", 2/Bag	BI	50	50	\$3.27
416-PB	5/16" × 2-1/4", 2/Bag	BI	50	50	\$3.90
417	1/4"-20", 7/16" Hex Nut, Nickel-Plated Steel	B	100	1000	\$0.18
418	5/16"-18", 9/16" Hex Nut, Nickel-Plated Steel	BI	100	1000	\$0.31
419	5/16" Washer, Nickel-Plated Steel	B	100	5000	\$0.20
<b>SNAPIT™ SOLID BRASS BOLTS</b>					
412-PB	1/4" × 2-1/4" With Captive Washer, 2/Bag	BI	50	50	\$3.01
414-PB	5/16" × 2-1/4" With Captive Washer, 2/Bag	BI	50	50	\$4.31



410-PB



412-PB

**PlumbPerfect™**

**Glass-Filled Nylon**

- Tensile strength exceeds 1,100 lbs. per bolt
- Thread design provides increased strength and smoother, faster threading.
- 100% corrosion proof bolts are available in convenient 2-1/2" and 3-1/2" lengths.
- Bolt base loads into any flange and open end nut fits 1/2" sockets
- Base design keeps bolt upright and does not allow bolt to spin in flange



425

Item Number	Item Description	Pkg Type	Min Qty	Case Qty	Price
425	2-1/2" Bolts w/ Open Nut, Bulk Box	B	100	100	\$0.58
425-PB	2-1/2" Bolts w/ Open Nut, 2/Bag	BI	50	50	\$1.22
427	3-1/2" Bolts w/ Open Nut, Bulk	B	100	100	\$0.68
427-PB	3-1/2" Bolts w/ Open Nut, 2/Bag	BI	50	50	\$1.40

**SmartCap™**

**Bolt Caps**

- Taller cap eliminates the need to cut bolts
- Base creates a tight seal that helps provide a continuous sanitary seal between base and toilet
- Cap threads onto base and is less likely to get lost or knocked off



440-2W



442-2B

Item Number	Item Description	Pkg Type	Min Qty	Case Qty	Price
<b>WHITE</b>					
440-2W	Cap w/ 425-PB Bolts, 2/Bag	CI	1	25	\$3.40
442-2W	Cap Only, 2/Bag	CI	1	25	\$2.28
<b>BONE</b>					
442-2B	Cap Only, 2/Bag	CI	25	25	\$2.63

Supply

Drainage

Support

Specialties

Appendix



490-11240

### Closet Bolt Cover Cap

Item Number	Item Description	Pkg Type	Min Qty	Case Qty	Price
490-11240	Economy Cap, White, 2/Bag	BI	25	500	\$1.61

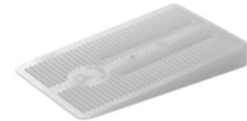

460-10



460-11310

### Wedgelt™

#### Closet Shims

- Stiff polypropylene is drivable
- Soft rubber-like PVC is easy to trim and resists slipping on tile floors
- Corrosion Proof
- Interlocking for stability and stacking

Item Number	Item Description	Pkg Type	Min Qty	Case Qty	Price
<b>STIFF POLYPROPYLENE</b>					
460-10	Closet Wedge, Bulk	B	100	1000	\$0.29
460-10J	Closet Wedge, 10/Bag, 20 Bar-Coded Bags In A Dispenser Box	BI	1	1	\$69.91
460-11300	Closet Wedge, 10/Bag	B	1	10	\$3.75
<b>SOFT PVC</b>					
460-11310	Closet Wedge, 10/Bag	B	1	10	\$4.76
460-20	Closet Wedge, Bulk	B	100	1000	\$0.44
460-20J	Closet Wedge, 10/Bag, 20 Bar-Coded Bags In A Dispenser Box	BI	1	1	\$89.19



402-10



402-427

### Closet Bowl Gaskets

#### Wax

- Plastic flange extends discharge opening
- Gasket forms a watertight, gas-tight and odor-tight seal
- Fits 3" and 4" waste lines
- Meets Fed spec TT-P-1536A

Item Number	Item Description	Pkg Type	Min Qty	Case Qty	Price
<b>GASKET ONLY</b>					
402-10	Gasket w/ Poly Flange, 1/Box	B	24	24	\$3.53
<b>GASKET KITS</b>					
402-410	(1) Gasket With Poly Flange, (2) 410-PB 1/4" × 2-1/4" Solid Brass Bolts & (2) 460-20 Soft PVC Wedges, 1/Kit	BI	24	24	\$6.12
402-427	(1) Gasket With Poly Flange, (2) 427-PB PlumbPerfect™ 3-1/2" Bolts, 1/Kit	BI	24	24	\$5.93
402-440	(1) Gasket With Poly Flange, (2) 425-PB PlumbPerfect™ 2-1/2" Bolts & (2) Smart Caps, 1/Kit	BI	24	24	\$9.14



**Closet Bowl Gaskets**

**Waxless Foam**

• Pre-drilled holes on wide flange model holds bolts upright, eliminating the need to double nut

Item Number	Item Description	Pkg Type	Min Qty	Case Qty	Price
490-10540	5-3/8" OD x 3-3/8" ID x 9/16" High, Sponge Rubber	B	10	10	\$8.28
490-10541	5-1/4" OD x 3-7/16" ID x 1/2" High, Sponge Rubber	B	10	10	\$6.99
490-10542	5-3/8" OD x 3-1/2" ID x 3/4" High, Sponge Rubber	B	10	10	\$8.19
490-10543	5-5/8" OD x 3-1/2" ID x 1" High, Sponge Rubber	B	10	10	\$9.60
<b>WITH CLOSET BOLT HOLES</b>					
490-10545	6-3/4" OD x 3-1/2" ID x 3/8" High, Sponge Rubber	B	10	10	\$7.52
490-10546	6-3/4" OD x 3-1/2" ID x 9/16" High, Sponge Rubber	B	10	10	\$9.33
490-10547	6-3/4" OD x 3-1/2" ID x 3/4" High, Sponge Rubber	B	10	10	\$10.37
490-10548	6-3/4" OD x 3-1/2" ID x 1" High, Sponge Rubber	B	10	10	\$13.92



490-10540



490-10545

**Tank-To-Bowl Repair**

Item Number	Item Description	Pkg Type	Min Qty	Case Qty	Price
<b>BOLTS</b>					
452-PB	23/32" Head, 2/Bag	BI	50	50	\$6.61
490-10500	Deluxe w/ 7/8" Head, 2/Bag	BI	1	50	\$10.17
<b>KITS</b>					
490-10555	Universal Kit Includes Gasket And 2 Bolts, 1/Bag	BI	1	25	\$9.57
490-10560	American Standard Kit Includes Gasket And 2 Bolts, 1/Bag	BI	1	25	\$10.05
490-10565	Gerber Kit Includes Gasket And 2 Bolts, 1/Bag	BI	1	25	\$9.57
490-10570	Kohler Kit Includes Gasket And 3 Bolts, 1/Bag	BI	1	25	\$13.31
490-10572	Kohler Kit Includes Sponge Rubber Gasket And 3 Bolts, 1/Bag	BI	1	25	\$13.40
490-10575	Eljer Kit Includes Gasket And 2 Bolts, 1/Bag	BI	1	25	\$9.57
490-10585	Mansfield Kit Includes Gasket And 3 Bolts, 1/Bag	BI	1	25	\$13.61
<b>GASKETS</b>					
490-10656	Universal	BI	25	25	\$1.68
490-10661	American Standard	BI	25	25	\$2.09
490-10666	Gerber	BI	25	25	\$2.27
490-10673	Kohler Green	BI	25	25	\$1.68
490-10676	Eljer	BI	25	25	\$2.24



452-PB



490-10555



490-10661

Supply

Drainage

Support

Specialties

Appendix



490-1080M2KIT

## Toilet Tank Fill Valves

### Governor™

- The Sioux Chief Governor™ 80M2 toilet fill valve is a triple function device; a toilet tank fill valve, an anti-siphon backflow preventer and a thermal expansion pressure relief valve.
- Limits the domestic water system's preset static pressure, protects the temperature and pressure relief valve on the water heater, reduces the requirement for a thermal expansion tank or an auxiliary relief valve.
- Relief valve set at 80psi

Item Number	Item Description	Pkg Type	Min Qty	Case Qty	Price
490-1080M2KIT	Governor 80M2 Adjustable Toilet Fill Valve & Flapper Kit, 1/Clamshell	BI	1	5	\$46.27

## Toilet Tank Fill Valves

### Anti-Siphon



490-10465

Item Number	Item Description	Pkg Type	Min Qty	Case Qty	Price
490-10465	8-1/2" Hoov-R-Line Replacement	BI	1	12	\$17.99

## Toilet Tank Flush Valves



490-11150

Item Number	Item Description	Pkg Type	Min Qty	Case Qty	Price
<b>FLUSH VALVES</b>					
490-11150	8" w/ Flapper	BI	1	12	\$10.41
490-11151	10" w/ Flapper	BI	1	12	\$10.75
<b>ACCESSORIES</b>					
490-11152	Universal Gasket Only For Flush Valve	BI	5	25	\$3.58

## ELJER Touch Flush KIT



490-10325

Item Number	Item Description	Pkg Type	Min Qty	Case Qty	Price
490-10325	Eljer Touch Flush Tank Ball And Handle Set	BI	1	12	\$12.18

**Tank Handles**

Item Number	Item Description	Pkg Type	Min Qty	Case Qty	Price
490-11100	Universal Metal Handle w/ Die Cast Nut & Cushion Washer, Chrome, 1/Bag	Bl	1	25	\$5.66
490-11120	Deluxe Metal Handle w/ Brass Nut & Cushion Washer, Chrome, 1/Bag	Bl	1	15	\$11.78
490-11140	Mansfield ABS, Chrome, 1/Bag	Bl	1	12	\$8.65
490-11157	American Standard ABS Neo Mount, Chrome, 1/Bag	Bl	1	12	\$8.22
490-11159	Eljer Side Mount w/ Brass Arm, Chrome, 1/Bag	Bl	1	12	\$11.01

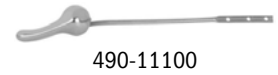

**Ringer™**

**Stainless Steel Repair Ring**

Item Number	Item Description	Pkg Type	Min Qty	Case Qty	Price
886-MR	Stnlis Steel Closet Ring	Cl	20	20	\$8.24



**Two-Piece Repair Ring**

**Galvanized Steel Repair Ring**

Item Number	Item Description	Pkg Type	Min Qty	Case Qty	Price
886-MRM	Two-Piece Flange Repair Ring Kit, 1/Card	Cl	8	8	\$24.67

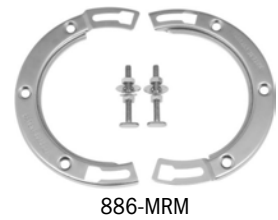

**Raise-A-Ring™**

**Closet Flange Extension Ring**

Item Number	Item Description	Pkg Type	Min Qty	Case Qty	Price
886-411	Raise-A-Ring Kit: One 886-R Ring w/ Closet Bolts And Two Shims, Bagged	Cl	20	20	\$7.16
886-R	7/16" Thick Flange Extension Ring, Carded	Cl	20	20	\$4.49
886-RQ	1/4" Thick Flange Extension Ring	Cl	20	20	\$3.12
886-RQK	Raise-A-Ring Kit: Three 886-Rq Rings w/ Closet Bolts, Bagged	Bl	25	25	\$10.53



**QuickSpacer™**

**Closet Flange Spacer Ring**

Item Number	Item Description	Pkg Type	Min Qty	Case Qty	Price
886-ER	3/4" Closet Flange Spacer Ring	Bl	25	25	\$2.89



Supply

Drainage

Support

Specialties

Appendix

Supply

Drainage

Support

Specialties

Appendix



490-11320

### Save-A-Flange™

#### Broken Flange Repair Kit

Item Number	Item Description	Pkg Type	Min Qty	Case Qty	Price
490-11320	Closet Flange Repair Kit	BI	1	10	\$7.76



490-11322

### Closet Flange Floor Support

#### Galvanized Steel Support Plates

Item Number	Item Description	Pkg Type	Min Qty	Case Qty	Price
490-11322	Floor Flange Support For Closet Flange, 1/Bag	CI	1	10	\$24.31



490-11520

### Misc Closet Repair

Item Number	Item Description	Pkg Type	Min Qty	Case Qty	Price
<b>SPUD GASKET</b>					
490-11520	1-1/4" Urinal Spud Gasket Only	B	5	25	\$1.45
490-11522	1-1/2" Closet Spud Gasket Only	B	5	25	\$1.38
490-11530	1" x 3/4" Urinal Spud Gasket Only	B	5	25	\$2.21



490-10700

<b>SLOAN VACUUM BREAKER</b>					
490-10700	Sloan Vacuum Breaker Kit	BI	1	12	\$3.02



490-10108

<b>FLAPPERS</b>					
490-10108	Blue Vinyl Chemical Resistant Flapper w/ 9" Stainless Steel Chain And Hook	BI	1	25	\$5.18
490-10110	Clear Vinyl Chemical Resistant 3-Way Flapper w/ 9" Stainless Steel Chain And Hook	BI	1	25	\$4.84
490-10112	Clear Vinyl Chemical Resistant 1.6 GPF Flapper w/ 4 Orifices, 9" Stainless Steel Chain And Hook	BI	1	25	\$8.74
490-10115	Kohler Round Replacement Flapper w/ 8" Stainless Steel Chain And Hook For 1 Pc. Toilets	BI	1	25	\$6.55
490-10117	Kohler Rialto One-Piece Replacement Flapper	BI	1	25	\$6.87
490-10120	ABS Flapper w/ TPR Seal, Replaces Kohler, American Standard And Coast.	BI	1	25	\$6.40
490-10121	ABS New Style 1.6 GPF Flapper w/ TPR Seal, Replaces Kohler And Coast.	BI	1	25	\$7.41
490-10122	TPR Seal Only For 490-10120 Flapper, 1/Bag	BI	1	25	\$1.43



490-10206

<b>REPLACEMENT PARTS</b>					
490-10206	Replacement 3" Tank Ball For Douglas Flush Valve	BI	1	25	\$4.97
490-10211	Replacement Tank Ball For Eljer Touch-Flush	BI	1	50	\$3.32
490-10302	American Standard Flush Valve Disc, Snap-On	BI	1	25	\$5.66
490-10312	American Standard Flush Valve Disc, Screw-On	BI	1	25	\$5.44
490-10320	American Standard Flush Valve Seal	BI	1	50	\$2.41
490-10340	Mansfield Old Style Flush Valve Gasket	BI	1	25	\$5.29
490-10341	Mansfield New Style Flush Valve Gasket	BI	1	25	\$2.75
490-10451	Float Ball Poly Bulk	BI	24	24	\$1.94

# **Tub/Shower Specialties**

**Tub Spouts**

**DrySeal™ Pipe Collar**

**Shower WallNut™**

**Shower Arms**

**Shower Heads**

**Add-A-Shower**



The innovative SmartSpout™ tightens flush to the finished wall - No Gap!  
The patented design installs over copper tube and uses an internal mechanism  
to pull itself tightly to the wall so no caulking is needed.



**972-36**  
**Page 639**



**972-100**  
**Page 639**



**616-02C**  
**Page 640**



**974-60306**  
**Page 640**



**974-60300**  
**Page 641**



**974-68200301**  
**Page 641**

Tub Spouts

SmartSpout™

- Installs directly onto 1/2" copper stub out with #2 Phillips driver
- Slip-fit convenience; secure, clean, tight to finished wall eliminating the need to caulk.
- 5-1/4" overall length in three finish options
- Free DySeal™ Pipe Collar included with every SmartSpout™
- Optional copper extension available; reduced end fits inside Type M or Type L copper



972-36



972-32RB



972-3RAKIT

Item Number	Item Description	Pkg Type	Min Qty	Case Qty	Price
<b>WITH DIVERTER</b>					
972-36	5/8" OD Slip Connect, Chrome, 1/Box	Bl	1	18	\$39.43
972-361PK2	5/8" OD Slip Connect & Adapter Kit, Chrome, 1/Clamshell	Bl	6	6	\$47.43
972-362PK2	5/8" OD Slip Connect & Adapter Kit, Satin Nickel, 1/Clamshell	Bl	6	6	\$55.43
972-363PK2	5/8" OD Slip Connect & Adapter Kit, Oil-Rubbed Bronze, 1/Clamshell	Bl	6	6	\$56.93
972-36RB	5/8" OD Slip Connect, Oil-Rubbed Bronze, 1/Box	Bl	1	18	\$47.81
972-36SN	5/8" OD Slip Connect, Satin Nickel, 1/Box	Bl	1	18	\$47.81
<b>NON-DIVERTER</b>					
972-32	5/8" OD Slip Connect, Chrome, 1/Box	Bl	1	18	\$35.46
972-32RB	5/8" OD Slip Connect, Oil-Rubbed Bronze, 1/Box	Bl	1	18	\$41.88
972-32SN	5/8" OD Slip Connect, Satin Nickel, 1/Box	Bl	1	18	\$41.88
<b>REPAIR ADAPTER</b>					
972-3RA	1/2" CTS Extension Only, 5/Bag	B	1	10	\$13.23

Tub Spouts

Standard

Item Number	Item Description	Pkg Type	Min Qty	Case Qty	Price
<b>WITH DIVERTER</b>					
972-15	1/2" FIP At Nose, Chrome, 1/Box	B	1	50	\$22.93
972-35	5/8" OD Slip Connect w/ 1-3/8" Adjustment, Chrome, 1/Box	B	1	50	\$29.58
<b>NON-DIVERTER</b>					
972-10	1/2" FIP At Nose, Chrome, 1/Box	B	1	50	\$12.45
972-20	3/4" FIP Connection At Nose (w/ 3/4"X 1/2" Bushing), Chrome, 1/Box	B	1	50	\$12.88
972-30	5/8" OD Slip Connect w/ 1-3/8" Adjustment, Chrome, 1/Box	B	1	50	\$23.15
<b>ACCESSORIES</b>					
972-100	Brass Escutcheon w/ Foam Gasket, Chrome, 1/Bag	Bl	1	12	\$14.43



972-35



972-10



972-100

Supply

Drainage

Support

Specialties

Appendix

Supply

Drainage

Support

Specialties

Appendix



928-2

### DrySeal™ Pipe Collar

- Thin, tapered design compresses tightly to wall creating a watertight seal around pipe or tube
- Helps keep moisture out of wall cavity which helps prevent mold growth

Item Number	Item Description	Pkg Type	Min Qty	Case Qty	Price
<b>CTS</b>					
928-2	1/2" CTS	B	50	500	\$0.27
928-2PK2	1/2" CTS, 10/Bag	BI	25	25	\$3.50
928-3	3/4" CTS	B	50	500	\$0.27
<b>IPS</b>					
928-12	1/2" IPS	B	50	500	\$0.27
928-12PK2	1/2" IPS, 10/Bag	BI	25	25	\$3.50
928-13	3/4" IPS	B	50	50	\$0.27
<b>SHOWER ARM</b>					
928-125	1/2" Shower Arm	B	50	500	\$0.27
928-125PK2	1/2" Shower Arm, 10/Bag	BI	25	25	\$3.50



616-02C

307-625

### Shower WallNut™

- Warning: the Shower WallNut™ system MUST be installed using a copper stub out and #525-16WLB bracket for warranty coverage.
- DO NOT use thread sealant or P.T.F.E. tape on Shower WallNut™ end of shower arm
- Stub out to shower arm connection is made outside the finished wall ensuring there are no hidden leaks behind the finished wall.
- Stub out with copper tube just like other fixtures
- Shower arm installation tool allows for easier install with no external damage

#### Related Products

Shower WallNut™ LockBlock™ p 516

Item Number	Item Description	Pkg Type	Min Qty	Case Qty	Price
<b>SHOWER ARM ADAPTER</b>					
616-02BM	Shower Arm Adapter, Matte Black, 1/Bag	BI	1	25	\$24.65
616-02C	Shower Arm Adapter, Chrome, 1/Bag	BI	25	25	\$9.17
616-02RB	Shower Arm Adapter, Oil-Rubbed Brnz, 1/Bag	BI	1	25	\$26.37
616-02SN	Shower Arm Adapter, Satin Nickel, 1/Bag	BI	1	25	\$26.37
<b>TOOLS</b>					
307-616	Shower WallNut Removal Tool	BI	1	10	\$39.08
307-625	Shower Arm Installation Tool	BI	1	6	\$11.06

### Shower Arms & Escutcheons



974-60306

Item Number	Item Description	Pkg Type	Min Qty	Case Qty	Price
974-60306	6" Brass Shower Arm, Chrome	BI	1	25	\$10.68
974-60308	8" Brass Shower Arm, Chrome	BI	1	25	\$12.29



**Shower Arms & Escutcheons (Cont)**

Item Number	Item Description	Pkg Type	Min Qty	Case Qty	Price
<b>ESCUTCHEONS</b>					
974-60310	Shower Arm Flange w/ Set Screw, Chrome, 1/Bag	Bl	1	10	\$4.35
<b>"S" ARM</b>					
974-60315	10" Brass S-Pattern Shower Arm, Chrome	Bl	1	10	\$38.88



974-60315

**Shower Heads**

Item Number	Item Description	Pkg Type	Min Qty	Case Qty	Price
974-60300	Showerhead Replacement 1-3/4" Face w/ Adjustable Spray, Chrome, 1/Box	Bl	1	6	\$50.29



974-60300

**Add-A-Shower**

**Add-A-Shower**

Item Number	Item Description	Pkg Type	Min Qty	Case Qty	Price
<b>BATH COCK TYPE</b>					
974-68100304	Bath Cock Type Add-On Shower Assembly Kit, Chrome, 1/Box	Bl	1	1	\$204.97
974-68200301	Bath Cock Type Add-On Shower Assembly Kit w/ Curtain Ring, Chrome, 1/Box	Bl	1	4	\$280.91
974-686003C04	Diverter, Bath Cock Only, Chrome, 1/Box	Bl	1	24	\$108.57
<b>SPOUT TYPE</b>					
974-68000304	Spout Type Add-On Shower Assembly Kit, Chrome, 1/Box	Bl	1	1	\$133.85



974-68200301



974-68000304

**Add-A-Shower**

**Add-A-Rod**

Item Number	Item Description	Pkg Type	Min Qty	Case Qty	Price
974-660303L04	5' Polished Aluminum Shower Rod Less Flanges	B	50	50	\$8.37
974-662303L04	6' Polished Aluminum Shower Rod Less Flanges	B	50	50	\$10.18
974-6633032H04	Corner Shower Rod w/ Support & Flanges, Polished Aluminum, 1/Box	Bl	1	1	\$67.51
974-668303BH	D-Shaped Shower Rod w/ Support & Flanges, Polished Aluminum, 1/Box	Bl	1	1	\$75.87
<b>ACCESSORIES</b>					
974-84410301	Shower Rod Ceiling Flange Only, Chrome, 1/Bag	Bl	1	50	\$12.05
974-85020300	Shower Rod Flange 1" With Screws, Chrome, 2/Bag	Bl	25	25	\$5.92
974-85033201	Jiffy Adjustable Shower Rod Flange, ABS, Chrome, 2/Bag	Bl	1	100	\$2.32



974-668303BH



974-85020300

Supply

Drainage

Support

Specialties

Appendix



# **Tubing & Hose**

**Vinyl Tubing**

**Polyethylene Tubing**

**Hose**

**Fuel Line**

**Gasket Material**

# Tubing & Hose

## Vinyl Tubing

Clear and black vinyl tubing is flexible and easy to connect for a variety of applications. Braided options available for higher-pressures. Not for use as dishwasher or ice maker supply.

## Polyethylene Tubing

Flexible polyethylene tubing can be used for dishwasher or ice maker supply, as well as other fixtures/appliances.

## Hose

A variety of supply and drain hoses in assorted materials and sizes for various applications.

## Fuel Line

Flexible tubing for fuel lines in small engines and motors.

## Gasket Material

Sheet material designed for cutting custom replacement gaskets and other flat seals.

# **Vinyl Tubing**

**Clear Vinyl Tubing**

**Black Vinyl Tubing**





## Clear Vinyl Tubing

### Clear Standard Tubing

- Polyvinyl Chloride is manufactured to exact specifications, which gives it the flexibility of rubber and the clarity of glass
- Handles a wide variety of chemicals, gases and liquids
- Makes a superior drainage line and can be used for protective insulation
- Do NOT use with ice makers or dishwashers



900-01023C01005

Item Number	Item Description	Pkg Type	Min Qty	Case Qty	Price
<b>1/8" I.D.</b>					
900-01021C04005	1/8" ID x 3/16" OD (1/32" Wall) 400' EZ Dispenser	BI	1	1	\$45.84
900-01023C01005	1/8" ID x 1/4" OD (1/16" Wall) 100' Reel	BI	1	1	\$20.39
<b>17/100" I.D.</b>					
900-01030C00101	17/100" ID x 1/4" OD (1/2"5" Wall) 10' Coil	CI	10	10	\$2.42
900-01030C00201	17/100" ID x 1/4" OD (1/2"5" Wall) 20' Coil	CI	10	10	\$4.16
900-01030C04005	17/100" ID x 1/4" OD (1/2"5" Wall) 400' Reel	BI	1	1	\$62.40
<b>3/16" I.D.</b>					
900-01053C00101	3/16" ID x 5/16" OD (1/16" Wall) 10' Coil	CI	10	10	\$3.35
900-01053C00201	3/16" ID x 5/16" OD (1/16" Wall) 20' Coil	CI	10	10	\$5.74
900-01053C03005	3/16" ID x 5/16" OD (1/16" Wall) 300' Reel	BI	1	1	\$64.67
<b>1/4" I.D.</b>					
900-01103C00101	1/4" ID x 3/8" OD (1/16" Wall) 10' Coil	CI	10	10	\$3.90
900-01103C00201	1/4" ID x 3/8" OD (1/16" Wall) 20' Coil	CI	10	10	\$6.68
900-01103C00501	1/4" ID x 3/8" OD (1/16" Wall) 50' Coil	CI	2	2	\$15.28
900-01103C01005	1/4" ID x 3/8" OD (1/16" Wall) 100' Reel	BI	1	1	\$27.09
900-01103C02505	1/4" ID x 3/8" OD (1/16" Wall) 250' Reel	BI	1	1	\$62.51
<b>5/16" I.D.</b>					
900-01153C00101	5/16" ID x 7/16" OD (1/16" Wall) 10' Coil	CI	10	10	\$4.72
900-01153C00201	5/16" ID x 7/16" OD (1/16" Wall) 20' Coil	CI	10	10	\$8.08
900-01153C02005	5/16" ID x 7/16" OD (1/16" Wall) 200' EZ Dispenser	BI	1	1	\$67.29
<b>3/8" I.D.</b>					
900-01163C00101	3/8" ID x 1/2" OD (1/16" Wall) 10' Coil	CI	10	10	\$5.22
900-01163C00201	3/8" ID x 1/2" OD (1/16" Wall) 20' Coil	CI	10	10	\$8.94
900-01163C00501	3/8" ID x 1/2" OD (1/16" Wall) 50' Coil	BI	1	1	\$20.47
900-01163C01005	3/8" ID x 1/2" OD (1/16" Wall) 100' Reel	BI	1	1	\$37.22
900-01164C01005	3/8" ID x 9/16" OD (3/32" Wall) 100' EZ Dispenser	BI	1	1	\$56.07
<b>1/2" I.D.</b>					
900-01203C00101	1/2" ID x 5/8" OD (1/16" Wall) 10' Coil	CI	10	10	\$6.09
900-01203C00201	1/2" ID x 5/8" OD (1/16" Wall) 20' Coil	CI	10	10	\$10.42
900-01203C00501	1/2" ID x 5/8" OD (1/16" Wall) 50' Coil	BI	1	1	\$23.89
900-01203C01005	1/2" ID x 5/8" OD (1/16" Wall) 100' Reel	BI	1	1	\$43.44
900-01206C00101	1/2" ID x 3/4" OD (1/8" Wall) 10' Coil	CI	10	10	\$12.00
900-01206C01005	1/2" ID x 3/4" OD (1/8" Wall) 100' Reel	BI	1	1	\$85.64

Supply

Drainage

Support

Specialties

Appendix

## Clear Vinyl Tubing (Cont)

### Clear Standard Tubing

Item Number	Item Description	Pkg Type	Min Qty	Case Qty	Price
<b>5/8" I.D.</b>					
900-01253C00101	5/8" ID × 3/4" OD (1/16" Wall) 10' Coil	CI	10	10	\$7.82
900-01253C00201	5/8" ID × 3/4" OD (1/16" Wall) 20' Coil	CI	5	5	\$13.38
900-01253C01005	5/8" ID × 3/4" OD (1/16" Wall) 100' EZ Dispenser	BI	1	1	\$55.81
900-01256C00101	5/8" ID × 7/8" OD (1/8" Wall) 10' Coil	CI	5	5	\$14.57
900-01256C01005	5/8" ID × 7/8" OD (1/8" Wall) 100' Reel	BI	1	1	\$103.99
<b>3/4" I.D.</b>					
900-01306C00101	3/4" ID × 1" OD (1/8" Wall) 10' Coil	CI	10	10	\$16.77
900-01306C00201	3/4" ID × 1" OD (1/8" Wall) 20' Coil	CI	5	5	\$28.74
900-01306C00755	3/4" ID × 1" OD (1/8" Wall) 75' Reel	BI	1	1	\$98.84
<b>1" I.D.</b>					
900-01406C00021	1" ID × 1-1/4" OD (1/8" Wall) 2' Length	CI	5	5	\$4.28
900-01406C00101	1" ID × 1-1/4" OD (1/8" Wall) 10' Coil	CI	5	5	\$21.40
900-01406C00505	1" ID × 1-1/4" OD (1/8" Wall) 50' Reel	BI	1	1	\$84.12
900-01406C01005	1" ID × 1-1/4" OD (1/8" Wall) 100' Reel	BI	1	1	\$152.92
<b>1-1/4" I.D.</b>					
900-01508C00255	1-1/4" ID × 1-5/8" OD (3/16" Wall) 25' Reel	BI	1	1	\$82.57
900-01508C00504	1-1/4" ID × 1-5/8" OD (3/16" Wall) 50' Reel	BI	1	1	\$151.40
<b>1-1/2" I.D.</b>					
900-01608C00505	1-1/2" ID × 1-7/8" OD (3/16" Wall) 50' Reel	BI	1	1	\$172.26

## Clear Vinyl Tubing

### Clear Braided

- Polyvinyl chloride reinforced with polyester braiding has four times the working pressure of single wall PVC tubing
- Offers superior performance under severe operating conditions, and is a first-rate choice for hydraulic, pneumatic, and vacuum lines

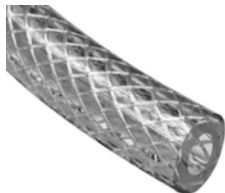

900-02106C00101

Item Number	Item Description	Pkg Type	Min Qty	Case Qty	Price
<b>1/4" I.D.</b>					
900-02106C00101	1/4" ID × 1/2" OD (1/8" Wall) 10' Coil	CI	10	10	\$8.86
900-02106C02505	1/4" ID × 1/2" OD (1/8" Wall) 250' Reel	BI	1	1	\$142.22
<b>3/8" I.D.</b>					
900-02166C00101	3/8" ID × 5/8" OD (1/8" Wall) 10' Coil	CI	10	10	\$10.53
900-02166C01505	3/8" ID × 5/8" OD (1/8" Wall) 150' Reel	BI	1	1	\$112.88
<b>1/2" I.D.</b>					
900-02206C00101	1/2" ID × 3/4" OD (1/8" Wall) 10' Coil	CI	10	10	\$13.21
900-02206C01005	1/2" ID × 3/4" OD (1/8" Wall) 100' Reel	BI	1	1	\$94.33
<b>5/8" I.D.</b>					
900-02256C00101	5/8" ID × 7/8" OD (1/8" Wall) 10' Coil	CI	10	10	\$14.74
900-02256C00755	5/8" ID × 7/8" OD (1/8" Wall) 75' Reel	BI	1	1	\$86.83

Supply

Drainage

Support

Specialties

Appendix



## Clear Vinyl Tubing (Cont)

### Clear Braided

Item Number	Item Description	Pkg Type	Min Qty	Case Qty	Price
<b>3/4" I.D.</b>					
900-02306C00101	3/4" ID × 1" OD (1/8" Wall) 10' Coil	CI	10	10	\$17.56
900-02306C00755	3/4" ID × 1" OD (1/8" Wall) 75' Reel	BI	1	1	\$103.48
<b>1" I.D.</b>					
900-02408C00101	1" ID × 1-3/8" OD (3/16" Wall) 10' Coil	CI	5	5	\$33.24
900-02408C00505	1" ID × 1-3/8" OD (3/16" Wall) 50' Reel	BI	1	1	\$130.62
<b>1-1/4" I.D.</b>					
900-02509C00021	1-1/4" ID × 1-3/4" OD (1/4" Wall) 2' Length	CI	5	5	\$11.65
900-02509C00505	1-1/4" ID × 1-3/4" OD (1/4" Wall) 50' Reel	BI	1	1	\$228.88
<b>1-1/2" I.D.</b>					
900-02609C00021	1-1/2" ID × 2" OD (1/4" Wall) 2' Length	CI	5	5	\$13.98
900-02609C00505	1-1/2" ID × 2" OD (1/4" Wall) 50' Reel	BI	1	1	\$274.77

## Black Vinyl Tubing

- Polyvinyl chloride is manufactured to exact specifications using FDA listed materials.
- Our black PVC tubing is UV and ozone resistant

Item Number	Item Description	Pkg Type	Min Qty	Case Qty	Price
<b>3/8" I.D.</b>					
900-01163N00101	3/8" ID × 1/2" OD (1/16" Wall) 10' Coil	CI	5	5	\$5.22
<b>1/2" I.D.</b>					
900-01203N00101	1/2" ID × 5/8" OD (1/16" Wall) 10' Coil	CI	5	5	\$6.09
<b>3/4" I.D.</b>					
900-01306N00101	3/4" ID × 1" OD (1/8" Wall) 10' Coil	CI	5	5	\$16.77



900-01163N00101



# **Polyethylene Tubing**

**Low-Density Polyethylene Tubing**



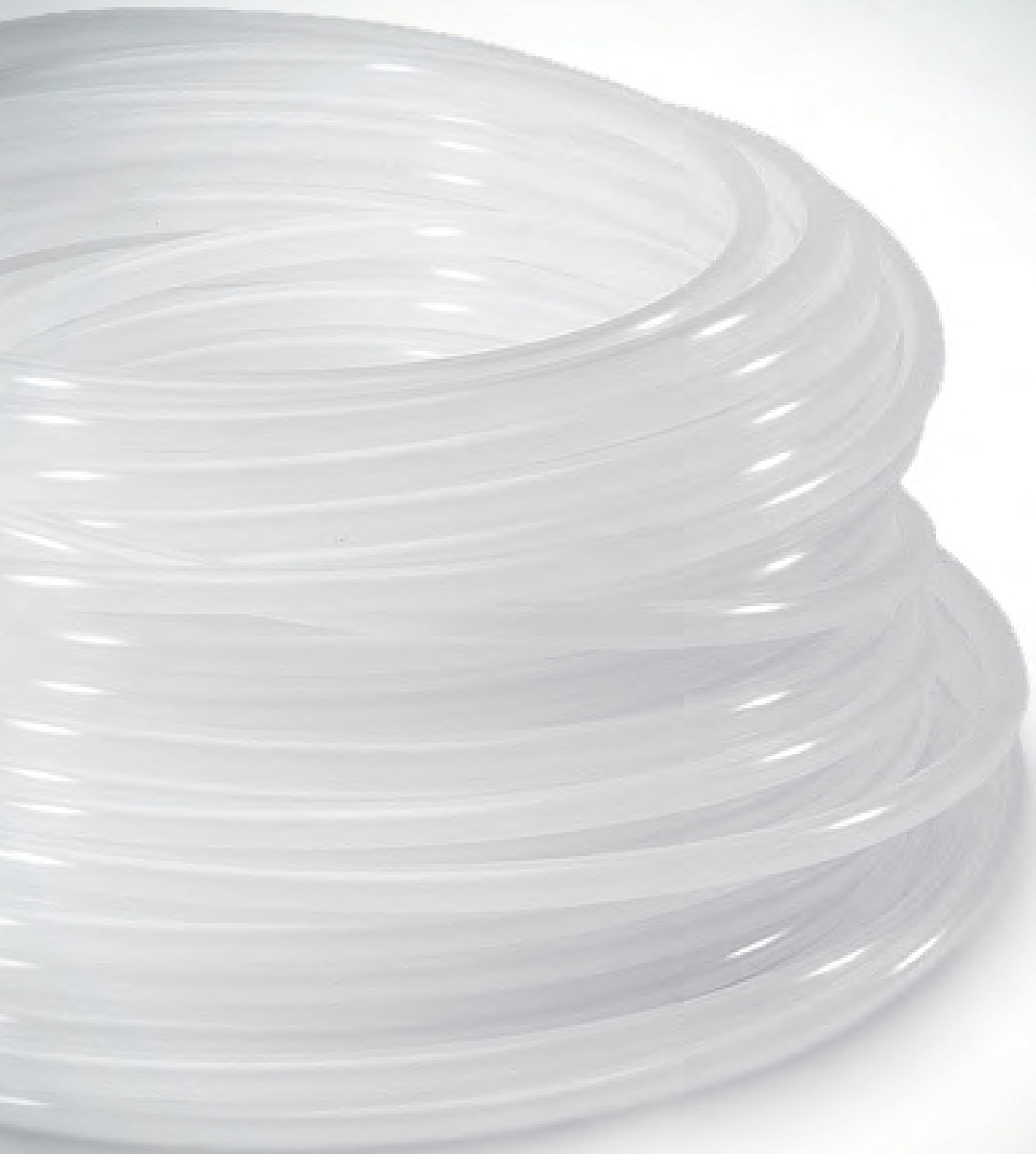

### Low-Density Polyethylene Tubing

- Low density polyethylene is manufactured to exact specifications from FDA listed material.
- Polyethylene naturally resists cracking, and makes excellent drinking water and pneumatic control lines.



901-03020W00251

Item Number	Item Description	Pkg Type	Min Qty	Case Qty	Price
<b>1/4" O.D.</b>					
901-03020W00251	1/4" OD x 17/100" ID (1/25" Wall) 25' Coil	CI	10	10	\$5.38
901-03020W00501	1/4" OD x 17/100" ID (1/25" Wall) 50' Coil	CI	5	5	\$9.84
901-03020W01001	1/4" OD x 17/100" ID (1/25" Wall) 100' Coil	BI	1	1	\$17.90
901-03020W01005	1/4" OD x 17/100" ID (1/25" Wall) 100' Reel	BI	1	1	\$17.90
901-03020W04005	1/4" OD X 17/100" ID (1/25" Wall), 400' Reel	BI	1	1	\$52.37
<b>5/16" O.D.</b>					
901-03053W00101	5/16" OD x 3/16" ID (1/16" Wall) 10' Coil	CI	5	5	\$3.90
901-03053W03005	5/16" OD x 3/16" ID (1/16" Wall) 300' EZ Dispenser	CI	1	1	\$74.55
<b>3/8" O.D.</b>					
901-03103W00251	3/8" x OD x 1/4" ID (1/16" Wall) 25' Coil	CI	10	10	\$9.35
901-03103W01005	3/8" OD x 1/4" ID (1/16" Wall) 100' Reel	BI	1	1	\$31.18
901-03103W03005	3/8" OD x 1/4" ID (1/16" Wall) 300' EZ Dispenser	BI	1	1	\$79.27
<b>1/2" O.D.</b>					
901-03163W00251	1/2" OD x 3/8" ID (1/16" Wall) 25' Coil	CI	5	5	\$11.56
901-03163W01005	1/2" OD x 3/8" ID (1/16" Wall) 100' Reel	BI	1	1	\$38.54
901-03163W02005	1/2" OD x 3/8" ID (1/16" Wall) 200' Reel	BI	1	1	\$73.70

Supply

Drainage

Support

Specialties

Appendix



# Hose

**Washer/Disposal Hose**

**Garden Hose**

**Heater/Utility Hose**

**Flexible PVC Spa Hose**

**Suction/Discharge Hose**

**Latex Hose**







## Dishwasher/Disposal Drain

### Drain Hose

- EPDM = Maximum operating temperature 225°F
- Braided Vinyl = Maximum operating temperature 185°F
- 5/8" connects dishwasher pump to air gap inlet, directly to a 5/8" branch tailpiece or to a disposal tap-in (with connector kit)
- 7/8" connects the air gap outlet to branch tailpiece or to a disposal tap-in



900-04258N00101



900-04338N00255

Item Number	Item Description	Pkg Type	Min Qty	Case Qty	Price
<b>EPDM HOSE</b>					
900-12256N00101	5/8" ID × 7/8" OD (1/8" Wall) Black 10' Coil	BI	10	5	\$21.25
905	Dishwasher Drain Hose 5/8" ID × 50' Coil, EZ Dispenser Box (Unit of Measure Per Box)	B	1	1	\$108.62
905-PK	Dishwasher Drain Hose 5/8" ID × 50' Coil, EZ Dispenser Box (Unit of Measure Per Foot)	B	50	50	\$2.22
906	Dishwasher Drain Hose 7/8" ID × 50' Coil, EZ Dispenser Box (Unit of Measure Per Box)	B	1	1	\$182.86
906-PK	Dishwasher Drain Hose 7/8" ID × 50' Coil, EZ Dispenser Box (Unit of Measure Per Foot)	B	50	50	\$3.71
<b>BRAIDED VINYL HOSE</b>					
900-04258N00101	Dishwasher Drain Hose 5/8" × 1" OD (3/16" Wall), 10' Coil	BI	10	10	\$22.40
900-04258N00505	Dishwasher Drain Hose 5/8" × 1" OD (3/16" Wall), 50' Reel	BI	1	1	\$93.30
900-04338N00021	7/8" ID × 1-1/4" OD (3/16" Wall) × 2'	BI	12	12	\$5.98
900-04338N00101	Dishwasher Drain Hose 7/8" ID × 1-1/4" OD (3/16" Wall), × 10' Coil	BI	5	5	\$29.86
900-04338N00255	Dishwasher Drain Hose 7/8" ID × 1-1/4" OD (3/16" Wall), × 25' Reel	BI	1	1	\$66.76

### Heater Hose

Item Number	Item Description	Pkg Type	Min Qty	Case Qty	Price
<b>EPDM HOSE</b>					
900-12306N00101	3/4" ID × 1" OD (1/8" Wall) Black 10' Coil	BI	10	5	\$29.02



900-12256N00101

### Garden Hose

Item Number	Item Description	Pkg Type	Min Qty	Case Qty	Price
900-07256G01505	5/8" ID × 7/8" OD (1/8" Wall) Green 150' Reel	BI	1	1	\$174.00

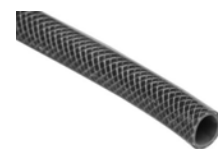

900-07256G01505

Supply

Drainage

Support

Specialties

Appendix

Supply



900-16300W00021

### Flexible PVC Spa Hose

- PVC compounds reinforced with a rigid PVC spiral helix make spa-flex strong, flexible, and easy to handle
- It conforms to any shape or contour, and is specifically sized to be glued into standard PVC fittings

Drainage

Support

Specialties

Item Number	Item Description	Pkg Type	Min Qty	Case Qty	Price
900-16200W01004	1/2" ID x 100' Reel, White	BI	1	1	\$175.41
900-16300W00021	3/4" ID x 2' Stick, White	CI	1	5	\$6.34
900-16300W00101	3/4" ID x 10' Coil, White	BI	1	1	\$31.74
900-16300W01004	3/4" ID x 100' Coil, White	BI	1	1	\$226.69
900-16400W00021	1" ID x 2' Stick, White	CI	1	5	\$7.56
900-16400W00101	1" ID x 10' Coil, White	BI	1	1	\$37.78
900-16400W00504	1" ID x 50' Coil, White	BI	1	1	\$144.81
900-16500W00021	1-1/4" ID x 2' Stick, White	CI	1	5	\$9.70
900-16500W00101	1-1/4" ID x 10' Coil, White	BI	1	1	\$48.49
900-16500W00504	1-1/4" ID x 50' Coil, White	BI	1	1	\$190.50
900-16600W00021	1-1/2" ID x 2' Stick, White	CI	1	5	\$9.91
900-16600W00101	1-1/2" ID x 10' Coil, White	BI	1	1	\$49.57
900-16600W00504	1-1/2" ID x 50' Coil, White	BI	1	1	\$194.73
900-16700W00021	2" ID x 2' Stick, White	CI	1	5	\$15.44
900-16700W00101	2" ID x 10' Coil, White	BI	1	1	\$77.20

### Suction/Discharge Hose

Item Number	Item Description	Pkg Type	Min Qty	Case Qty	Price
<b>PUMP &amp; BILGE HOSE</b>					
900-18300W00061	3/4" ID x 6' Coil, White	CI	3	3	\$10.17
900-18430W00061	1-1/8" ID x 6' Coil, White	CI	3	3	\$11.78
<b>FLAT DISCHARGE HOSE (NON-REINFORCED)</b>					
900-19600B00251	1-1/2" ID x 25' Coil, Blue	CI	5	5	\$19.16
900-19600B00501	1-1/2" ID x 50' Coil, Blue	CI	5	5	\$35.10
900-19700B00251	2" ID x 25' Coil, Blue	CI	5	5	\$34.18
900-19700B00501	2" ID x 50' Coil, Blue	CI	5	5	\$62.65

Appendix

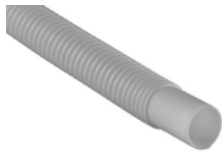

900-18300W00061



900-19600B00251

### Latex Hose

- This natural latex tubing maintains its flexibility under extreme temperatures from subzero to steam sterilization
- This tubing is a superior choice for drain tubes, o-ring gaskets, elastic bands, photographic chemicals and tourniquet bands



900-06103Y00101

Item Number	Item Description	Pkg Type	Min Qty	Case Qty	Price
900-06103Y00101	1/4" ID x 3/8" OD (1/16 Wall) Yellow 10' Coil	CI	5	5	\$20.44
900-06103Y00505	1/4" ID x 3/8" OD (1/16 Wall) Yellow 50' Reel	BI	1	1	\$85.16

# Fuel Line

Polyurethane Micro Fuel Line

Polyester Reinforced Fuel Line

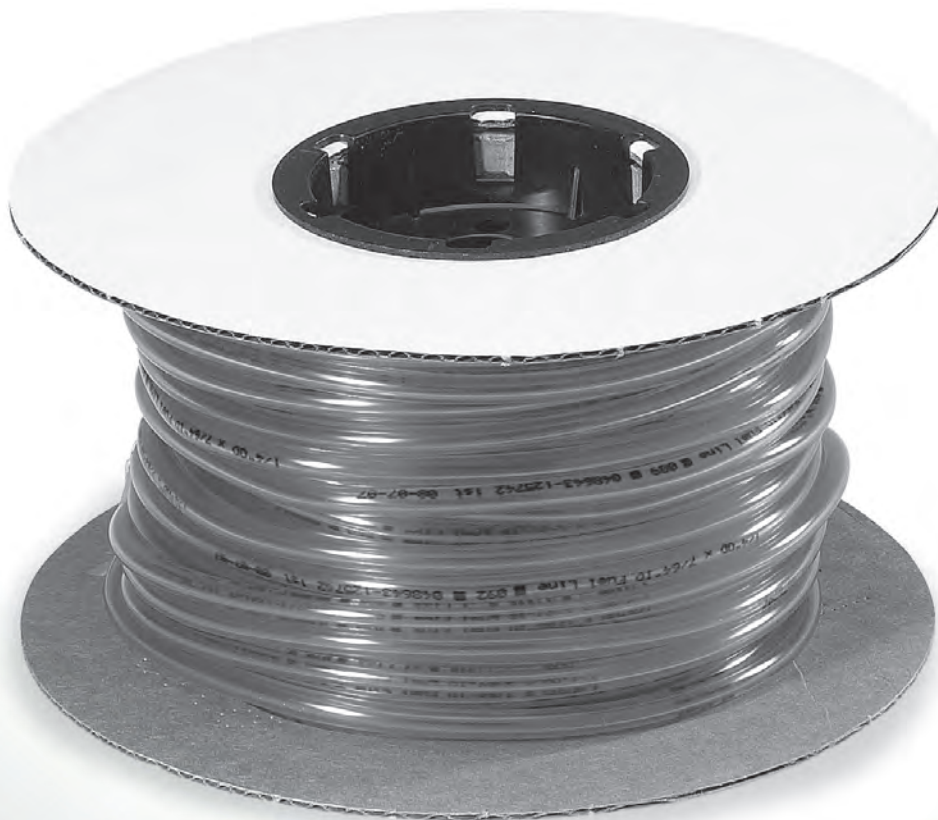

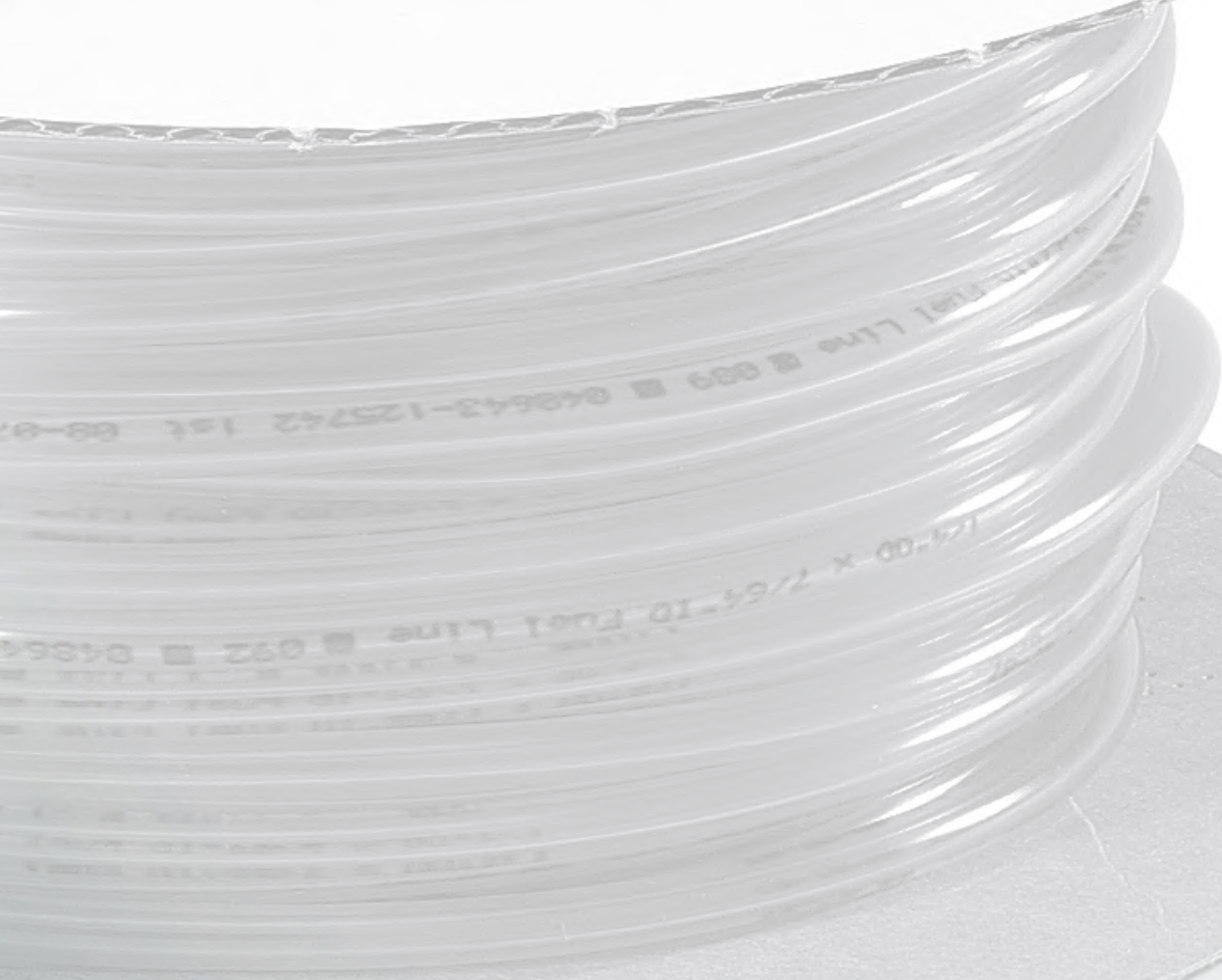
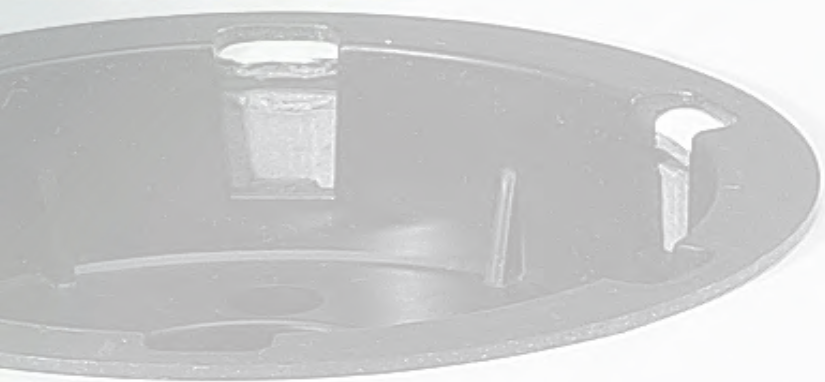
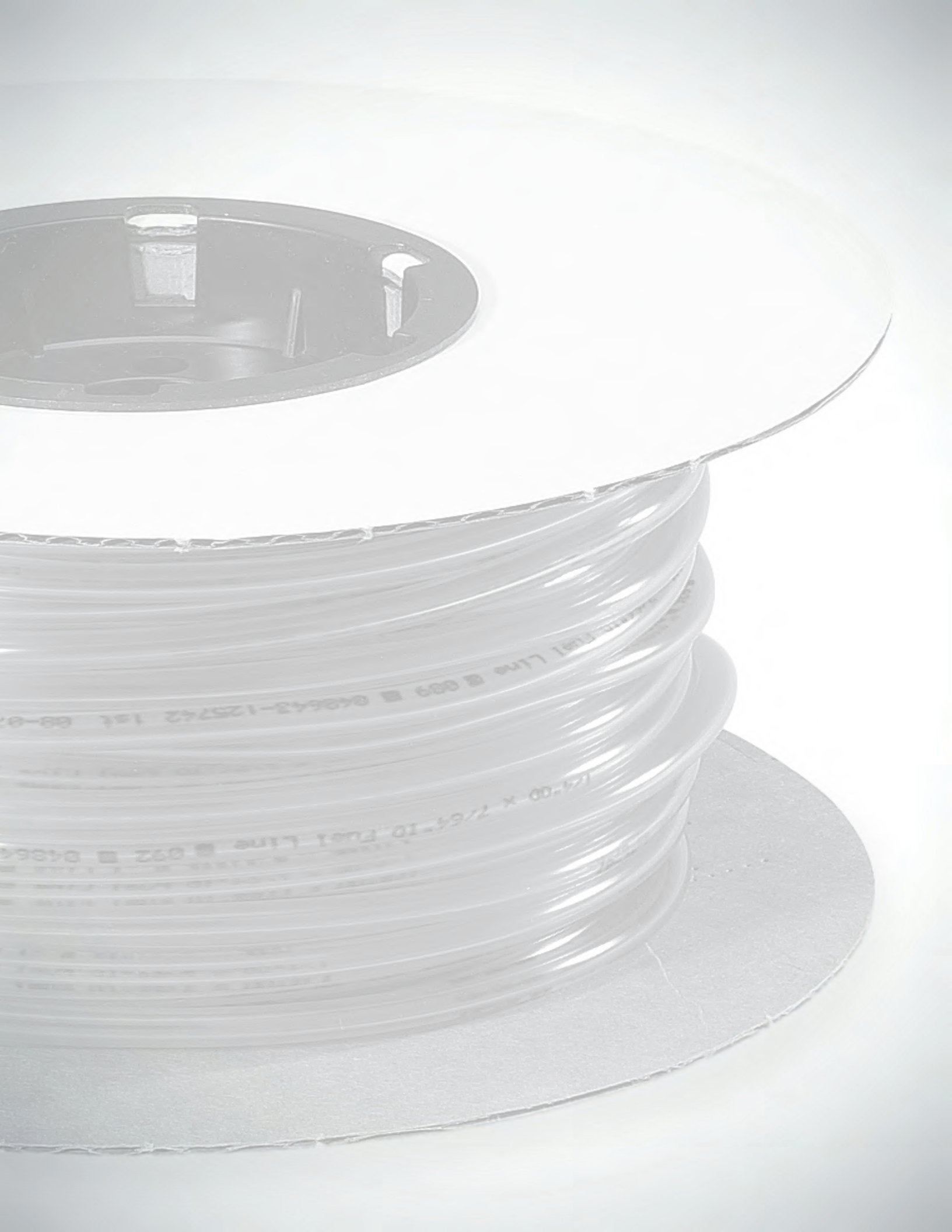

### Polyurethane Micro Fuel Line

- Micro fuel line is manufactured with polyurethane, with no plasticizers that can cause flow contamination or tube hardening
- Polyurethane's wide operating temperature range and superior resistance to oil, grease, and fuels make it the right choice for a long lasting fuel line



900-14010R00051

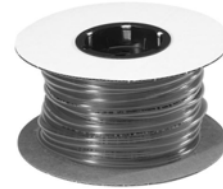

900-14018R01004

Item Number	Item Description	Pkg Type	Min Qty	Case Qty	Price
<b>1/4" OD</b>					
900-14010R00051	7/64" ID × 1/4" OD, Orange, 5' Coil	BI	10	10	\$5.74
900-14010R01005	7/64" ID × 1/4" OD, Orange, 100' Reel	BI	1	1	\$95.64
900-14023R00101	1/8" ID × 1/4 OD, Orange, 10' Coil	BI	5	5	\$9.54
<b>3/16" OD</b>					
900-14018R00051	3/32" ID × 3/16 OD, Orange, 5' Coil	BI	10	10	\$5.87
900-14018R01004	3/32" ID × 3/16 OD, Orange, 100' Reel	BI	1	1	\$97.80

### Polyester Reinforced Fuel Line

- This fuel line is made of PVC compounds blended with special additives for use with petroleum products.
- This tubing is made for the transfer of petroleum based products when used as a fuel line, vapor emissions line, or vacuum smog control line.
- NOT FOR FUEL INJECTION APPLICATIONS



900-15106N00051



900-15166N00051

Item Number	Item Description	Pkg Type	Min Qty	Case Qty	Price
<b>1/2" OD</b>					
900-15106N00051	1/4" ID × 1/2", 5' Coil	CI	5	5	\$8.07
900-15106N01005	1/4" ID × 1/2", 100' Reel	BI	1	1	\$115.14
<b>5/8" OD</b>					
900-15157N00051	5/16" ID × 5/8", 5' Coil	CI	1	10	\$6.98
900-15166N00051	3/8" ID × 5/8", 5' Coil	CI	1	10	\$8.74

Supply

Drainage

Support

Specialties

Appendix



# **Gasket Material**

**Flat Gasket Material**







**Flat Gasket Material**

Item Number	Item Description	Pkg Type	Min Qty	Case Qty	Price
<b>BLACK</b>					
899-333N0033	1/16" × 12" Cloth Inserted Rubber, 33' Reel	Bl	1	1	\$190.62
<b>RED</b>					
899-306R0009	1/8" × 12" Rubber, 9' Reel	Bl	1	1	\$85.48



899-303N0033

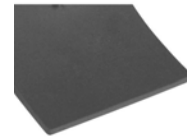

899-306R0018

Supply

Drainage

Support

Specialties

Appendix



# **Tubing/Hose Fittings**

**Compression, Flare**

**Brass Thread, Nylon Thread**

**Pipe Nipples, Poly Push Fittings**

**Hose Barb Fittings**

**Garden Hose Fittings**

**Hose Clamps, Valves & Cocks**

**Pool Hose Fittings**

# Tubing/Hose Fittings

## Compression Fittings

Compression fittings in brass and nylon material. Brass fittings for standard and Ander-Lign connections available.

## Flare Fittings

Brass flare fittings in standard and fine-thread styles. Flare fittings for LPG and gas range connection available.

## Threaded Fittings

Thread fittings in brass and nylon material. Brass fittings in bar-stock, forged, and cast options available.

## Pipe Nipples

Threaded pipe nipples in yellow brass, chrome-plated yellow brass, and red brass.

## Polypropylene Push Fittings

Easy-to-use polypropylene push fittings for use with LDPE tubing.

## Hose Barb Fittings

Fittings and adapters for hose barb connection in brass and nylon material.

## Garden Hose Fittings

Fittings and adapters for garden hose connection in brass and nylon material.

## Hose Clamps

Stainless steel worm-gear hose clamps and quick-connecting EasyClamps.

## Valves & Cocks

Self-piercing and drill-type saddle valves, drain cocks, and shutoff cocks.

## Pool Hose Fittings

Couplings and cuff fittings for pool hose.

# Brass Compression Fittings

**Couplings**

**Reducing Couplings**

**Tees**

**Elbows**

**Straight Adapters**

**Elbow Adapters**

**Ferrules**

**Caps**

**Nuts & Inserts**

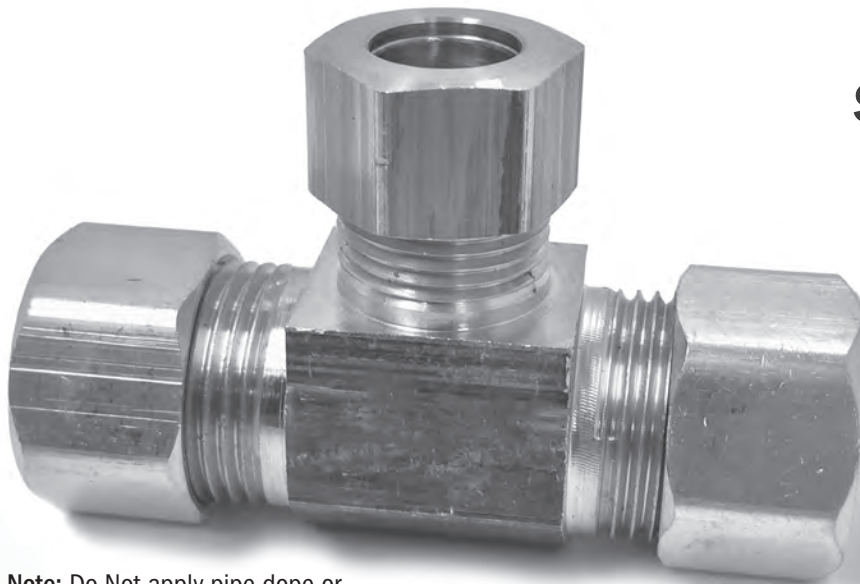

**Note:** Do Not apply pipe dope or other sealants to compression threads



**907-120201**  
Page 671



**907-13201001**  
Page 671



**907-1916161001**  
Page 672



**907-251601**  
Page 672



**907-40102005**  
Page 673

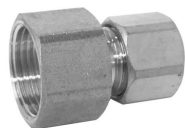

**907-44021001**  
Page 675



**907-43102001**  
Page 676



**907-27101601**  
Page 676



**909-32102001**  
Page 677



**907-010003**  
Page 678

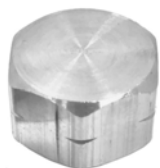

**907-490201**  
Page 678



**907-080003**  
Page 679



**908-12020201**  
Page 683



**908-13100201**  
Page 683



**908-2002020201**  
Page 683



**908-25020201**  
Page 683



**908-40020201**  
Page 683



**908-27020201**  
Page 684

**Brass Compression Couplings**

Item Number	Item Description	Pkg Type	Min Qty	Case Qty	Price
<b>COMPRESSION</b>					
907-120201	1/4" OD Comp, 1/Bag	Bl	5	60	\$4.48
907-120205	1/4" OD Comp, 5/Bag	Bl	1	60	\$19.59
907-120210	1/4" OD Comp, 10/Bag	Bl	5	20	\$38.46
907-121001	3/8" OD Comp, 1/Bag	Bl	5	60	\$5.64
907-121005	3/8" OD Comp, 5/Bag	Bl	5	60	\$25.39
907-121601	1/2" OD Comp, 1/Bag	Bl	5	60	\$8.47
907-121605	1/2" OD Comp, 5/Bag	Bl	5	60	\$39.48
907-122001	5/8" OD Comp, 1/Bag	Bl	5	60	\$10.08
907-122005	5/8" OD Comp, 5/Bag	Bl	1	50	\$47.60
907-123001	7/8" OD Comp, 1/Bag	Bl	2	24	\$16.05
<b>ANDER-LIGN WITH BRASS INSERTS</b>					
909-120201	1/4" OD Ander-Lign, 1/Bag	Bl	10	120	\$4.02
909-120501	5/16" OD Ander-Lign, 1/Bag	Bl	5	60	\$4.35
909-121001	3/8" OD Ander-Lign, 1/Bag	Bl	10	120	\$4.73
909-121601	1/2" OD Ander-Lign, 1/Bag	Bl	5	60	\$8.17
909-122001	5/8" OD Ander-Lign, 1/Bag	Bl	5	60	\$10.32
909-122501	3/4" OD Ander-Lign, 1/Bag	Bl	5	60	\$20.48
909-123001	7/8" OD Ander-Lign, 1/Bag	Bl	2	24	\$15.82
909-123009	7/8" OD Ander-Lign, 5/Bag	Bl	3	9	\$163.75
<b>ANDER-LIGN LESS INSERTS</b>					
909-120001	1/8" OD Ander-Lign, 1/Bag	Bl	5	60	\$5.40
909-120101	3/16" OD Ander-Lign, 1/Bag	Bl	5	60	\$3.21

**Brass Compression Reducing Couplings**

Item Number	Item Description	Pkg Type	Min Qty	Case Qty	Price
<b>COMPRESSION</b>					
907-13100201	3/8" x 1/4" OD Comp, 1/Bag	Bl	5	60	\$4.57
907-13201001	5/8" x 3/8" OD Comp, 1/Bag	Bl	5	40	\$6.68
<b>ANDER-LIGN WITH BRASS INSERTS</b>					
909-13050201	5/16" x 1/4" OD Ander-Lign, 1/Bag	Bl	5	40	\$10.55
909-13100201	3/8" x 1/4" OD Ander-Lign, 1/Bag	Bl	5	60	\$7.29
909-13160201	1/2" x 1/4" OD Ander-Lign, 1/Bag	Bl	5	20	\$14.42
909-13161001	1/2" x 3/8" OD Ander-Lign, 1/Bag	Bl	5	60	\$7.38
909-13201001	5/8" x 3/8" OD Ander-Lign, 1/Bag	Bl	5	60	\$8.38
909-13201601	5/8" x 1/2" OD Ander-Lign, 1/Bag	Bl	5	60	\$14.42
909-13201605	5/8" x 1/2" OD Ander-Lign, 5/Bag	Bl	5	15	\$89.25
909-13302001	7/8" x 5/8" OD Ander-Lign, 1/Bag	Bl	2	24	\$26.69
<b>ANDER-LIGN LESS INSERTS</b>					
909-13161060	1/2" x 3/8" OD Ander-Lign, 5/Bag	Bl	5	60	\$43.57



907-120201



909-120201



909-120001



907-13201001



909-13100201

Supply

Drainage

Support

Specialties

Appendix

Supply

Drainage

Support

Specialties

Appendix



907-201001

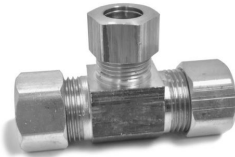

907-1916161001

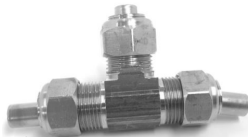

909-201001

### Brass Compression Tees

Item Number	Item Description	Pkg Type	Min Qty	Case Qty	Price
<b>STANDARD TEE</b>					
907-201001	3/8" OD Comp, 1/Bag	BI	5	60	\$7.18
<b>REDUCING TEE</b>					
907-1916161001	1/2" × 1/2" × 3/8" OD Comp, 1/Bag	BI	5	60	\$22.99
907-1920201601	5/8" × 5/8" × 1/2" OD Comp, 1/Bag	BI	5	60	\$17.44
907-1930302001	7/8" × 7/8" × 5/8" OD Comp, 1/Bag	BI	2	24	\$59.21
907-24101001	3/8" × 3/8" OD Comp × 1/4" MIP, 1/Bag	BI	5	60	\$7.77
907-24202001	5/8" × 5/8" OD Comp × 1/2" MIP, 1/Bag	BI	5	60	\$16.44

### Brass Compression Tees

#### Ander-Lign With Brass Inserts

Item Number	Item Description	Pkg Type	Min Qty	Case Qty	Price
<b>STANDARD TEE</b>					
909-183001	7/8" OD Ander-Lign, 1/Bag	BI	2	24	\$46.73
909-200201	1/4" OD Ander-Lign, 1/Bag	BI	5	60	\$6.88
909-201001	3/8" OD Ander-Lign, 1/Bag	BI	5	120	\$7.49
909-201601	1/2" OD Ander-Lign, 1/Bag	BI	5	40	\$13.48
909-202001	5/8" OD Ander-Lign, 1/Bag	BI	5	60	\$15.05
<b>REDUCING TEE</b>					
909-21100201	3/8" × 3/8" × 1/4" OD Ander-Lign, 1/Bag	BI	5	60	\$8.98

### Brass Compression Elbows

Item Number	Item Description	Pkg Type	Min Qty	Case Qty	Price
<b>STANDARD</b>					
907-251601	1/2" OD Comp, 1/Bag	BI	5	60	\$9.03
<b>ANDER-LIGN WITH BRASS INSERTS</b>					
909-250201	1/4" OD Ander-Lign, 1/Bag	BI	5	40	\$6.19
909-251001	3/8" OD Ander-Lign, 1/Bag	BI	5	40	\$6.20
909-251601	1/2" OD Ander-Lign, 1/Bag	BI	5	20	\$11.05
909-252001	5/8" OD Ander-Lign, 1/Bag	BI	5	60	\$13.05
909-263001	7/8" OD Ander-Lign, 1/Bag	BI	2	24	\$39.02



907-251601

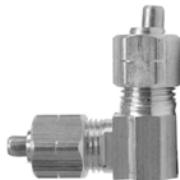

909-250201



**Brass Compression Straight Adapters**

**Female Compression**

Item Number	Item Description	Pkg Type	Min Qty	Case Qty	Price
<b>FEMALE COMPRESSION × FEMALE COMPRESSION</b>					
907-541001	3/8" OD Female Comp, 1/Bag	Bl	5	60	\$5.32
<b>FEMALE COMPRESSION × COMPRESSION</b>					
907-47100200	3/8" OD Female Comp × 1/4" OD Comp, 100/Box	B	1	10	\$249.25
907-47100201	3/8" OD Female Comp × 1/4" OD Comp, 1/Bag	Bl	5	60	\$2.71
907-47101601	3/8" OD Female Comp × 1/2" OD Comp, 1/Bag	Bl	5	20	\$4.16
907-47151001	7/16" OD Female Comp × 3/8" OD Comp, 1/Bag	Bl	5	60	\$4.03
907-47161001	1/2" OD Female Comp × 3/8" OD Comp, 1/Bag	Bl	5	40	\$2.49
<b>ANDER-LIGN × FEMALE COMPRESSION LESS INSERTS</b>					
909-14100201	3/8" OD Ander-Lign × 1/4" OD Female Comp, 1/Bag	Bl	5	60	\$5.63

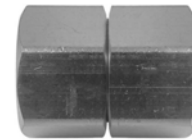

907-541001



907-47100200

**Brass Compression Straight Adapters**

**Compression × MIP**

Item Number	Item Description	Pkg Type	Min Qty	Case Qty	Price
<b>1/4" COMPRESSION</b>					
907-40021001	1/4" OD Comp × 1/4" MIP, 1/Bag	Bl	5	60	\$3.35
<b>3/8" COMPRESSION</b>					
907-40101001	3/8" OD Comp × 1/4" MIP, 1/Bag	Bl	5	60	\$3.74
907-40102005	3/8" OD Comp × 1/2" MIP, 5/Bag	Bl	1	60	\$21.99
907-41102001	3/8" OD Comp × 1/2" MIP, 1/Bag	Bl	5	60	\$5.77
907-41201005	3/8" OD Comp × 1/2" MIP, 5/Bag	Bl	5	20	\$25.67
<b>1/2" COMPRESSION</b>					
907-4016200505	1/2" OD Comp × 1/2" MIP, 5/Bag	Bl	5	60	\$28.98
<b>5/8" COMPRESSION</b>					
907-4020200505	5/8" OD Comp × 1/2" MIP, 5/Bag	Bl	5	60	\$31.10
907-41202001	5/8" OD Comp × 1/2" MIP, 1/Bag	Bl	5	60	\$6.88
<b>7/8" COMPRESSION</b>					
907-40303001	7/8" OD Comp × 3/4" MIP, 1/Bag	Bl	2	24	\$10.90



907-40102005

**Brass Compression Straight Adapters**

**Ander-Lign With Brass Insert × MIP**

Item Number	Item Description	Pkg Type	Min Qty	Case Qty	Price
<b>1/4" ANDER-LIGN COMPRESSION</b>					
909-40021001	1/4" OD Ander-Lign × 1/4" MIP, 1/Bag	Bl	5	60	\$3.35
909-41020201	1/4" OD Ander-Lign × 1/8" MIP, 1/Bag	Bl	5	60	\$3.01
909-41021601	1/4" OD Ander-Lign × 3/8" MIP, 1/Bag	Bl	5	60	\$3.93
909-41022001	1/4" OD Ander-Lign × 1/2" MIP, 1/Bag	Bl	5	60	\$5.40
<b>5/16" ANDER-LIGN COMPRESSION</b>					
909-41051001	5/16" OD Ander-Lign × 1/4" MIP, 1/Bag	Bl	5	20	\$3.97



909-40021001

Supply

Drainage

Support

Specialties

Appendix

**Brass Compression Straight Adapters (Cont)**

**Ander-Lign With Brass Insert × MIP**



909-40303001

Item Number	Item Description	Pkg Type	Min Qty	Case Qty	Price
<b>3/8" ANDER-LIGN COMPRESSION</b>					
909-40100201	3/8" OD Ander-Lign × 1/8" MIP, 1/Bag	BI	5	60	\$4.52
909-40101601	3/8" OD Ander-Lign × 3/8" MIP, 1/Bag	BI	5	60	\$4.68
909-41101001	3/8" OD Ander-Lign × 1/4" MIP, 1/Bag	BI	5	60	\$4.02
909-41102001	3/8" OD Ander-Lign × 1/2" MIP, 1/Bag	BI	10	120	\$5.78
909-41103001	3/8" OD Ander-Lign × 3/4" MIP, 1/Bag	BI	5	20	\$10.55
<b>1/2" ANDER-LIGN COMPRESSION</b>					
909-40162001	1/2" OD Ander-Lign × 1/2" MIP, 1/Bag	BI	5	60	\$7.27
909-41161601	1/2" OD Ander-Lign × 3/8" MIP, 1/Bag	BI	5	60	\$5.72
909-41163001	1/2" OD Ander-Lign × 3/4" MIP, 1/Bag	BI	5	60	\$7.51
<b>5/8" ANDER-LIGN COMPRESSION</b>					
909-40201601	5/8" OD Ander-Lign × 3/8" MIP, 1/Bag	BI	5	20	\$6.96
909-40203001	5/8" OD Ander-Lign × 3/4" MIP, 1/Bag	BI	5	60	\$14.06
909-41202001	5/8" OD Ander-Lign × 1/2" MIP, 1/Bag	BI	5	60	\$7.06
<b>3/4" ANDER-LIGN COMPRESSION</b>					
909-40253001	3/4" OD Ander-Lign × 3/4" MIP, 1/Bag	BI	5	60	\$16.15
<b>7/8" ANDER-LIGN COMPRESSION</b>					
909-40303001	7/8" OD Ander-Lign × 3/4" MIP, 1/Bag	BI	2	24	\$11.94

**Brass Compression Straight Adapters**

**Ander-Lign Less Insert × MIP**



909-40000201

Item Number	Item Description	Pkg Type	Min Qty	Case Qty	Price
<b>1/8" ANDER-LIGN COMPRESSION</b>					
909-40000201	1/8" OD Ander-Lign × 1/8" MIP, 1/Bag	BI	5	60	\$7.02
<b>3/16" ANDER-LIGN COMPRESSION</b>					
909-40010201	3/16" OD Ander-Lign × 1/8" MIP, 1/Bag	BI	5	60	\$3.47
<b>5/16" ANDER-LIGN COMPRESSION</b>					
909-41050200	5/16" OD Ander-Lign × 1/8" MIP, 1/Bag	BI	5	60	\$7.88
<b>7/8" ANDER-LIGN COMPRESSION</b>					
909-41302001	7/8" OD Ander-Lign × 1/2" MIP, 1/Bag	BI	2	24	\$21.79
909-41303007	7/8" OD Ander-Lign × 3/4 MIP, 2/Clamshell	BI	5	30	\$15.25

**Brass Compression Straight Adapters**

**Female Compression × MIP**



907-58202001

Item Number	Item Description	Pkg Type	Min Qty	Case Qty	Price
<b>3/8" FEMALE COMPRESSION</b>					
907-58101001	3/8" Female Comp × 1/4" MIP, 1/Bag	BI	5	60	\$3.57
<b>1/2" FEMALE COMPRESSION</b>					
907-58161601	1/2" Female Comp × 3/8" MIP, 1/Bag	BI	5	60	\$4.14
<b>5/8" FEMALE COMPRESSION</b>					
907-58202001	5/8" Female Comp × 1/2" MIP, 1/Bag	BI	5	60	\$5.19

Supply

Drainage

Support

Specialties

Appendix

**Brass Compression Straight Adapters**

**Compression × FIP**

Item Number	Item Description	Pkg Type	Min Qty	Case Qty	Price
<b>1/4" COMPRESSION</b>					
907-44021001	1/4" OD Comp × 1/4" FIP, 1/Bag	Bl	5	60	\$4.52
<b>3/8" COMPRESSION</b>					
907-44101601	3/8" OD Comp × 3/8" FIP, 1/Bag	Bl	5	60	\$3.60
907-4410200505	3/8" OD Comp × 1/2" FIP, 5/Bag	Bl	5	60	\$21.44
907-45102001	3/8" OD Comp × 1/2" FIP, 1/Bag	Bl	5	60	\$4.53
<b>1/2" COMPRESSION</b>					
907-44162001	1/2" OD Comp × 1/2" FIP, 1/Bag	Bl	5	60	\$5.56
<b>5/8" COMPRESSION</b>					
907-44203001	5/8" OD Comp × 3/4" FIP, 1/Bag	Bl	5	60	\$9.30
907-45202001	5/8" OD Comp × 1/2" FIP, 1/Bag	Bl	5	60	\$6.38



907-44021001

**Brass Compression Straight Adapters**

**Ander-Lign With Brass Insert × FIP**

Item Number	Item Description	Pkg Type	Min Qty	Case Qty	Price
<b>1/4" ANDER-LIGN COMPRESSION</b>					
909-44021001	1/4" OD Ander-Lign × 1/4" FIP, 1/Bag	Bl	5	60	\$6.43
909-44021601	1/4" OD Ander-Lign × 3/8" FIP, 1/Bag	Bl	5	20	\$5.28
909-44022001	1/4" OD Ander-Lign × 1/2" FIP, 1/Bag	Bl	5	40	\$3.75
909-45020201	1/4" OD Ander-Lign × 1/8" FIP, 1/Bag	Bl	5	60	\$3.58
909-45022001	1/4" OD Ander-Lign × 1/2" FIP, 1/Bag	Bl	5	40	\$5.28
<b>5/16" ANDER-LIGN COMPRESSION</b>					
909-45051001	5/16" OD Ander-Lign × 1/4" FIP, 1/Bag	Bl	5	20	\$5.85
<b>3/8" ANDER-LIGN COMPRESSION</b>					
909-44101601	3/8" OD Ander-Lign × 3/8" FIP, 1/Bag	Bl	5	60	\$7.50
909-45101001	3/8" OD Ander-Lign × 1/4" FIP, 1/Bag	Bl	5	40	\$5.58
909-45102001	3/8" OD Ander-Lign × 1/2" FIP, 1/Bag	Bl	10	120	\$6.30
<b>1/2" ANDER-LIGN COMPRESSION</b>					
909-44161601	1/2" OD Ander-Lign × 3/8" FIP, 1/Bag	Bl	5	20	\$8.01
909-44162001	1/2" OD Ander-Lign × 1/2" FIP, 1/Bag	Bl	5	60	\$12.56
<b>5/8" ANDER-LIGN COMPRESSION</b>					
909-44203001	5/8" OD Ander-Lign × 3/4" FIP, 1/Bag	Bl	5	20	\$15.13
909-45202001	5/8" OD Ander-Lign × 1/2" FIP, 1/Bag	Bl	5	60	\$7.02
<b>7/8" ANDER-LIGN COMPRESSION</b>					
909-44303001	7/8" OD Ander-Lign × 3/4" FIP, 1/Bag	Bl	2	24	\$16.15



909-44021001



909-44303001

**Brass Compression Straight Adapters**

**Ander-Lign Less Insert × FIP**

Item Number	Item Description	Pkg Type	Min Qty	Case Qty	Price
<b>3/8" ANDER-LIGN COMPRESSION</b>					
909-44103001	3/8" OD Ander-Lign × 3/4" FIP, No Insert, 1/Bag	Bl	5	60	\$14.57



909-44103001

Supply

Drainage

Support

Specialties

Appendix

Supply



930-46101001

### Brass Compression Straight Adapters

#### Female Compression x FIP

Item Number	Item Description	Pkg Type	Min Qty	Case Qty	Price
930-46101001	Gauge Adapter - 1/4" Swiv Comp. X 1/4" FIP, 1/Bag	BI	5	60	\$4.42

Drainage



907-43102001

### Brass Compression Straight Adapters

#### FSWT Adapters

Item Number	Item Description	Pkg Type	Min Qty	Case Qty	Price
<b>COMPRESSION x FSWT</b>					
907-43102001	3/8" OD Comp x 1/2" FSWT, 1/Bag	BI	5	60	\$4.83
<b>ANDER-LIGN WITH BRASS INSERT x FSWT</b>					
909-43102001	3/8" OD Ander-Lign x 1/2" FSWT, 1/Bag	BI	5	40	\$4.92

Support



909-43102001

Specialties

### Brass Compression to Flare Adapters



907-480201

Item Number	Item Description	Pkg Type	Min Qty	Case Qty	Price
907-480201	1/4" OD Comp x 1/4" Female Flare w/Gasket, 1/Bag	BI	5	60	\$4.44
907-481001	3/8" OD Comp x 3/8" Female Flare w/Gasket, 1/Bag	BI	5	40	\$3.24

Appendix

### Brass Compression Elbow Adapters

#### Compression x MIP



907-27101601

Item Number	Item Description	Pkg Type	Min Qty	Case Qty	Price
<b>3/8" COMPRESSION</b>					
907-27101601	3/8" OD Comp x 3/8" MIP, 1/Bag	BI	5	60	\$5.34
907-27101605	3/8" OD Comp x 3/8" MIP, 5/Bag	BI	5	20	\$23.35
907-28102001	3/8" OD Comp x 1/2" MIP, 1/Bag	BI	1	10	\$68.58

**Brass Compression Elbow Adapters**

**Ander-Lign With Brass Insert × MIP**

Item Number	Item Description	Pkg Type	Min Qty	Case Qty	Price
<b>1/4" ANDER-LIGN COMPRESSION</b>					
909-29021001	1/4" OD Ander-Lign × 1/4" MIP, 1/Bag	Bl	5	40	\$4.48
909-30020201	1/4" OD Ander-Lign × 1/8" MIP, 1/Bag	Bl	5	40	\$4.39
<b>3/8" ANDER-LIGN COMPRESSION</b>					
909-29101601	3/8" OD Ander-Lign × 3/8" MIP, 1/Bag	Bl	5	60	\$5.81
909-30101001	3/8" OD Ander-Lign × 1/4" MIP, 1/Bag	Bl	5	40	\$5.26
909-30102001	3/8" OD Ander-Lign × 1/2" MIP, 1/Bag	Bl	5	40	\$10.30
<b>1/2" ANDER-LIGN COMPRESSION</b>					
909-29162001	1/2" OD Ander-Lign × 1/2" MIP, 1/Bag	Bl	5	20	\$7.27
909-30161601	1/2" OD Ander-Lign × 3/8" MIP, 1/Bag	Bl	5	40	\$8.03
<b>5/8" ANDER-LIGN COMPRESSION</b>					
909-30201601	5/8" OD Ander-Lign × 3/8" MIP, 1/Bag	Bl	5	20	\$10.40
909-30202001	5/8" OD Ander-Lign × 1/2" MIP, 1/Bag	Bl	5	40	\$10.48



909-29021001

**Brass Compression Elbow Adapters**

**Ander-Lign Less Insert × MIP**

Item Number	Item Description	Pkg Type	Min Qty	Case Qty	Price
<b>3/16" ANDER-LIGN COMPRESSION</b>					
909-28010201	3/16" OD Ander-Lign × 1/8" MIP, 1/Bag	Bl	5	60	\$5.37
<b>1/4" ANDER-LIGN COMPRESSION</b>					
909-28021601	1/4" OD Ander-Lign × 3/8" MIP, 1/Bag	Bl	5	60	\$5.48
<b>5/16" ANDER-LIGN COMPRESSION</b>					
909-28051001	5/16" OD Ander-Lign × 1/4" MIP, 1/Bag	Bl	5	60	\$5.62



909-28010201

**Brass Compression Elbow Adapters**

**Ander-Lign Less Insert × FIP**

Item Number	Item Description	Pkg Type	Min Qty	Case Qty	Price
909-32102001	3/8" OD Ander-Lign × 1/2" FIP, 1/Bag	Bl	5	60	\$8.44
909-32202001	5/8" OD Ander-Lign × 1/2" FIP, 1/Bag	Bl	5	60	\$15.13



909-32102001

Supply

Drainage

Support

Specialties

Appendix

Supply

Drainage

Support

Specialties

Appendix



907-010003



907-050202



907-020203



907-490201

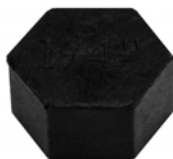

688-C0B

### Ferrules

Item Number	Item Description	Pkg Type	Min Qty	Case Qty	Price
<b>BRASS COMPRESSION</b>					
907-010003	1/8" OD Comp, 3/Bag	BI	5	60	\$1.58
907-010103	3/16" OD Comp, 3/Bag	BI	5	60	\$1.46
907-010203	1/4" OD Comp, 3/Bag	BI	10	120	\$1.30
907-010225	1/4" OD Comp, 25/Bag	BI	5	60	\$4.81
907-010503	5/16" OD Comp, 3/Bag	BI	5	20	\$1.46
907-011003	3/8" OD Comp, 3/Bag	BI	10	120	\$1.35
907-011025	3/8" OD Comp, 25/Bag	BI	5	20	\$7.06
907-011603	1/2" OD Comp, 3/Bag	BI	5	60	\$1.49
907-011625	1/2" OD Comp, 25/Bag	BI	5	60	\$12.35
907-012003	5/8" OD Comp, 3/Bag	BI	5	60	\$1.96
907-012503	3/4" OD Comp, 3/Bag	BI	5	60	\$4.52
907-013003	7/8" OD Comp, 3/Bag	BI	5	60	\$3.63
<b>POLY COMPRESSION WITH BRASS INSERT</b>					
907-050202	1/4" OD Comp, 2/Bag	BI	10	120	\$2.71
907-050502	5/16" OD Comp, 2/Bag	BI	5	60	\$3.64
907-051002	3/8" OD Comp, 2/Bag	BI	5	60	\$2.12
907-051602	1/2" OD Comp, 2/Bag	BI	5	60	\$2.30
907-052002	5/8" OD Comp, 2/Bag	BI	5	20	\$3.77
<b>POLY COMPRESSION LESS INSERT</b>					
907-020203	1/4" OD Comp, 3/Bag	BI	10	120	\$0.89
907-020210	1/4" OD Comp, 10/Bg	BI	1	480	\$2.98
907-020225	1/4" OD Comp, 25/Bag	BI	1	60	\$3.62
907-020510	5/16" OD Comp, 10/Bag	BI	10	3000	\$9.51
907-021000	3/8" OD Comp, 100/Bx	BI	1	50	\$11.94
907-021003	3/8" OD Comp, 3/Bag	BI	10	120	\$1.28
907-021025	3/8" OD Comp, 25/Bag	BI	5	60	\$6.13
907-021600	1/2" OD Comp, 100/Bx	BI	1	50	\$13.93
907-022003	5/8" OD Comp, 3/Bag	BI	5	20	\$1.32
907-022010	5/8" OD Comp, 10/Bg	BI	1	150	\$3.71

### Caps

• Brass compression caps require a brass compression ferrule to create a seal

Item Number	Item Description	Pkg Type	Min Qty	Case Qty	Price
<b>BRASS CAPS</b>					
907-490201	1/4" OD Comp, 1/Bag	BI	5	60	\$1.29
907-490501	5/16" OD Comp, 1/Bag	BI	5	60	\$1.51
907-491001	3/8" OD Comp, 1/Bag	BI	5	60	\$0.89
907-491010	3/8" OD Comp, 10/Bag	BI	5	60	\$9.03
907-491601	1/2" OD Comp, 1/Bag	BI	5	40	\$1.08
907-492001	5/8" OD Comp, 1/Bag	BI	5	40	\$1.18
<b>NYLON CAPS</b>					
688-C0B	1/4" Nylon Comp. Thread Cap, 10/Bag	BI	1	10	\$5.56
688-C1B	3/8" Nylon Comp. Thread Cap, 25/Bag	BI	1	4	\$6.67

**Nuts & Inserts**

Item Number	Item Description	Pkg Type	Min Qty	Case Qty	Price
<b>BRASS COMPRESSION NUTS</b>					
907-080003	1/8" OD Comp, 3/Bag	Bl	5	60	\$2.71
907-080103	3/16" OD Comp, 3/Bag	Bl	5	60	\$2.04
907-080203	1/4" OD Comp, 3/Bag	Bl	10	120	\$2.30
907-080225	1/4" OD Comp, 25/Bag	Bl	25	70	\$13.87
907-080503	5/16" OD Comp, 3/Bag	Bl	5	60	\$3.02
907-081000	3/8" OD Comp, 100/Bag	Bl	100	25	\$63.63
907-081003	3/8" OD Comp, 3/Bag	Bl	10	120	\$2.86
907-081025	3/8" OD Comp, 25/Bag	Bl	5	20	\$18.84
907-081603	1/2" OD Comp, 3/Bag	Bl	5	40	\$4.91
907-081625	1/2" OD Comp, 25/Bag	Bl	5	60	\$35.73
907-082003	5/8" OD Comp, 3/Bag	Bl	5	40	\$5.33
907-082025	5/8" OD Comp, 25/Bag	Bl	5	30	\$39.18
907-083003	7/8" OD Comp, 3/Bag	Bl	5	60	\$8.76
<b>CHROME-PLATED BRASS COMPRESSION NUTS/FERRULES</b>					
908-061002	3/8" OD Comp, 2/Bag	Bl	5	60	\$2.81
908-061602	1/2" OD Comp, 2/Bag	Bl	5	20	\$5.98
908-070202	1/4" OD Comp, 2/Bag	Bl	5	60	\$2.12
908-071002	3/8" OD Comp, 2/Bag	Bl	5	60	\$4.03
908-081001	3/8" OD Comp, 1/Bag	Bl	5	60	\$2.20
<b>ANDER-LIGN BRASS INSERTS</b>					
909-030200	1/4" OD Ander-Lign, 100/Box	Bl	1	50	\$14.74
909-030203	1/4" OD Ander-Lign, 3/Bag	Bl	5	60	\$1.86
909-030503	5/16" OD Ander-Lign, 3/Bag	Bl	5	60	\$1.85
909-031000	3/8" OD Ander-Lign, 100/Bag	Bl	1	50	\$21.74
909-031003	3/8" OD Ander-Lign, 3/Bag	Bl	5	60	\$2.31
909-031603	1/2" OD Ander-Lign, 3/Bag	Bl	5	60	\$1.76
909-032003	5/8" OD Ander-Lign, 3/Bag	Bl	5	60	\$2.09
909-032010	5/8" OD Ander-Lign, 10/Bag	Bl	1	10	\$5.33
<b>ANDER-LIGN BRASS NUTS/INSERTS</b>					
909-070201	1/4" OD Comp, 1/Bag	Bl	10	120	\$1.79
909-070501	5/16" OD Comp, 1/Bag	Bl	5	60	\$2.54
909-071001	3/8" OD Comp, 1/Bag	Bl	10	120	\$2.10
909-071601	1/2" OD Comp, 1/Bag	Bl	5	20	\$3.52
909-072001	5/8" OD Comp, 1/Bag	Bl	5	40	\$5.73
909-073001	7/8" OD Comp, 1/Bag	Bl	5	60	\$7.55

**Pilot Line Breakaway Compression Nut**

Item Number	Item Description	Pkg Type	Min Qty	Case Qty	Price
907-L990201	1/4" OD Comp Breakaway Nut, 1/Bag	Bl	10	120	\$2.46



907-080003



908-061002



909-030200



909-070201



907-L990201

Supply

Drainage

Support

Specialties

Appendix





# **Nylon Compression Fittings**

**Couplings**

**Reducing Couplings**

**Tees**

**Elbows**

**Straight Adapters**

**Elbow Adapters**





**Nylon Couplings**

Item Number	Item Description	Pkg Type	Min Qty	Case Qty	Price
908-12020201	1/4" OD Comp	BI	5	60	\$4.99
908-12101001	3/8" OD Comp	BI	5	60	\$7.40
908-12161601	1/2" OD Comp	BI	5	60	\$18.88



908-12020201

**Nylon Reducing Couplings**

Item Number	Item Description	Pkg Type	Min Qty	Case Qty	Price
908-13100201	3/8" x 1/4" OD Comp	BI	5	60	\$5.63
908-13161001	1/2" x 3/8" OD Comp	BI	5	60	\$7.02



908-13100201

**Nylon Tees**

Item Number	Item Description	Pkg Type	Min Qty	Case Qty	Price
908-2002020201	1/4" x 1/4" x 1/4" OD Comp	BI	5	60	\$7.38
908-2010101001	3/8" x 3/8" x 3/8" OD Comp	BI	5	60	\$11.54
908-2210101001	1/4" x 1/4" OD Comp x 1/4" MIP	BI	5	60	\$7.75



908-2002020201

**Nylon Elbows**

Item Number	Item Description	Pkg Type	Min Qty	Case Qty	Price
908-25020201	1/4" OD Comp	BI	5	60	\$5.98
908-25101001	3/8" OD Comp	BI	5	60	\$7.38



908-25020201

**Nylon Straight Adapters**

**MIP**

Item Number	Item Description	Pkg Type	Min Qty	Case Qty	Price
908-40020201	1/4" OD Comp x 1/8" MIP	BI	5	60	\$3.86
908-40021001	1/4" OD Comp x 1/4" MIP	BI	5	60	\$3.50
908-40021601	1/4" OD Comp x 3/8" MIP	BI	5	60	\$4.22
908-40100201	3/8" OD Comp x 1/8" MIP	BI	5	60	\$4.25
908-40101001	3/8" OD Comp x 1/4" MIP	BI	5	60	\$4.27
908-40101601	3/8" OD Comp x 3/8" MIP	BI	5	60	\$4.54
908-40161601	1/2" OD Comp x 3/8" MIP	BI	5	60	\$5.28
908-40162001	1/2" OD Comp x 1/2" MIP	BI	5	60	\$5.28



908-40020201

**Nylon Elbow Adapters**

**MIP**



908-27020201

Item Number	Item Description	Pkg Type	Min Qty	Case Qty	Price
908-27020201	1/4" OD Comp × 1/8" MIP	BI	5	60	\$6.68
908-27021001	1/4" OD Comp × 1/4" MIP	BI	5	60	\$6.61
908-27021601	1/4" OD Comp × 3/8" MIP	BI	5	60	\$4.95
908-27101001	3/8" OD Comp × 1/4" MIP	BI	5	60	\$6.39

Supply

Drainage

Support

Specialties

Appendix

# Brass Flare Fittings

## Flare

Couplings

Reducing  
Couplings

Swivel Unions

Tees, Elbows

Straight  
Adapters

Elbow Adapters

Caps, Nuts

Plugs

## Fine-Thread Flare

Couplings

Tees

Straight Adapters

Elbow Adapters

Compression  
Adapters

Caps, Nuts





**975-103001**  
Page 687



**975-13161010**  
Page 687



**975-46202001**  
Page 687



**975-2020202001**  
Page 687



**975-251001**  
Page 688



**975-40021601**  
Page 688



**975-442016**  
Page 689



**975-27101010**  
Page



**975-31101601**  
Page 690

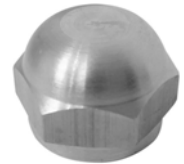

**975-490201**  
Page 690



**975-510205**  
Page 691



**978-12101001**  
Page 691



**978-201001**  
Page 691



**978-40102001**  
Page 691



**978-44101001**  
Page 691



**978-27101605**  
Page 691

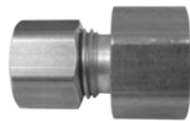







**978-47021001**  
Page 692



**979-400201**  
Page 695



**958-48322001**  
Page 695

 <b>975-103001</b> Page 687	 <b>975-13161010</b> Page 687	 <b>975-46202001</b> Page 687	 <b>975-2020202001</b> Page 687	 <b>975-251001</b> Page 688
 <b>975-40021601</b> Page 688	 <b>975-442016</b> Page 689	 <b>975-27101010</b> Page	 <b>975-31101601</b> Page 690	 <b>975-490201</b> Page 690
 <b>975-510205</b> Page 691	 <b>978-12101001</b> Page 691	 <b>978-201001</b> Page 691	 <b>978-40102001</b> Page 691	 <b>978-44101001</b> Page 691
 <b>978-27101605</b> Page 691	 <b>978-47021001</b> Page 692	 <b>979-400201</b> Page 695	 <b>958-48322001</b> Page 695	

**Brass Flare Couplings**

Item Number	Item Description	Pkg Type	Min Qty	Case Qty	Price
975-103001	7/8" OD Flare, 1/Bag	BI	2	24	\$33.98
975-120201	1/4" OD Flare, 1/Bag	BI	5	20	\$2.23
975-121001	3/8" OD Flare, 1/Bag	BI	5	60	\$2.88
975-121601	1/2" OD Flare, 1/Bag	BI	5	60	\$5.39
975-122001	5/8" OD Flare, 1/Bag	BI	5	20	\$7.28

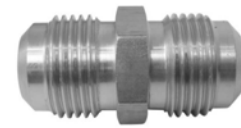

975-103001

**Brass Flare Reducing Couplings**

Item Number	Item Description	Pkg Type	Min Qty	Case Qty	Price
975-13100201	3/8" x 1/4" OD Flare, 1/Bag	BI	5	20	\$3.11
975-13161001	1/2" x 3/8" OD Flare, 1/Bag	BI	5	60	\$3.98
975-13161010	1/2" x 3/8" OD Flare, 5/Bag	BI	5	15	\$33.96
975-13201001	5/8" x 3/8" OD Flare, 1/Bag	BI	5	60	\$8.54
975-13201601	5/8" x 1/2" OD Flare, 1/Bag	BI	5	60	\$5.90

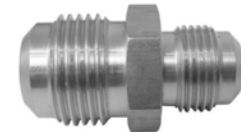

975-13161001

**Brass Flare Swivel Unions**

Item Number	Item Description	Pkg Type	Min Qty	Case Qty	Price
975-46161601	1/2" OD Female Flare, 1/Bag	BI	5	40	\$7.83
975-46202001	5/8" OD Female Flare, 1/Bag	BI	5	60	\$10.93
975-540201	1/4" OD Female Flare, 1/Bag	BI	5	60	\$5.54
975-L541001	3/8" OD Female Flare, 1/Bag	BI	5	60	\$5.91



975-46202001

**Brass Flare Tees**

Item Number	Item Description	Pkg Type	Min Qty	Case Qty	Price
<b>STANDARD TEE</b>					
975-200201	1/4" OD Flare, 1/Bag	BI	5	20	\$4.56
975-201001	3/8" OD Flare, 1/Bag	BI	5	60	\$5.97
975-201601	1/2" OD Flare, 1/Bag	BI	5	60	\$6.45
975-2020202001	5/8" OD Flare, 1/Bag	BI	5	20	\$11.07
<b>REDUCING TEE</b>					
975-2110100201	3/8" x 3/8" x 1/4" OD Flare, 1/Bag	BI	5	60	\$7.07
975-2116161001	1/2" x 1/2" x 3/8" OD Flare, 1/Bag	BI	5	60	\$7.92
975-2120201601	5/8" x 5/8" x 1/2" OD Flare, 1/Bag	BI	5	60	\$12.63



975-2020202001



975-2110100201

Supply

Drainage

Support

Specialties

Appendix



975-251001

### Brass Flare Elbows

Item Number	Item Description	Pkg Type	Min Qty	Case Qty	Price
975-251001	3/8" OD Flare, 1/Bag	BI	5	40	\$4.65
975-251010	3/8" OD Flare, 10/Bag	BI	5	15	\$40.70
975-251601	1/2" OD Flare, 1/Bag	BI	5	40	\$6.71
975-25202001	5/8" OD Flare, 1/Bag	BI	5	60	\$10.48



975-40021601

### Brass Flare Straight Adapters

#### MIP

Item Number	Item Description	Pkg Type	Min Qty	Case Qty	Price
<b>1/4" FLARE</b>					
975-40020001	1/4" OD Flare × 1/8" MIP, 1/Bag	BI	5	40	\$2.23
975-40021001	1/4" OD Flare × 1/4" MIP, 1/Bag	BI	5	40	\$2.11
975-40021601	1/4" OD Flare × 1/2" MIP, 1/Bag	BI	5	60	\$4.17
975-41021601	1/4" OD Flare × 3/8" MIP, 1/Bag	BI	5	60	\$3.50
<b>5/16" FLARE</b>					
975-40050001	5/16" OD Flare × 1/8" MIP, 1/Bag	BI	5	60	\$2.73
975-40050201	5/16" OD Flare × 1/4" MIP, 1/Bag	BI	5	60	\$2.45
<b>3/8" FLARE</b>					
975-40100001	3/8" OD Flare × 1/8" MIP, 1/Bag	BI	5	60	\$5.93
975-401010	3/8" OD Flare × 3/8" MIP, 5/Bag	BI	5	15	\$26.29
975-40101601	3/8" OD Flare × 3/8" MIP, 1/Bag	BI	5	60	\$2.90
975-40101605	3/8" OD Flare × 1/2" MIP, 5/Bag	BI	5	60	\$25.63
975-40102501	3/8" OD Flare × 3/4" MIP, 1/Bag	BI	5	60	\$6.57
975-41101001	3/8" OD Flare × 1/4" MIP, 1/Bag	BI	5	40	\$2.45
975-41102001	3/8" OD Flare × 1/2" MIP, 1/Bag	BI	10	120	\$3.72
<b>1/2" FLARE</b>					
975-40161605	1/2" OD Flare × 1/2" MIP, 5/Bag	BI	5	60	\$26.61
975-40162001	1/2" OD Flare × 1/2" MIP, 1/Bag	BI	5	60	\$3.98
975-401625	1/2" OD Flare × 3/4" MIP, 5/Bag	BI	5	15	\$84.76
975-40162501	1/2" OD Flare × 3/4" MIP, 1/Bag	BI	5	60	\$6.39
975-41161601	1/2" OD Flare × 3/8" MIP, 1/Bag	BI	5	60	\$3.52
<b>5/8" FLARE</b>					
975-40201001	5/8" OD Flare × 3/8" MIP, 1/Bag	BI	5	60	\$5.41
975-40201605	5/8" OD Flare × 3/8" MIP, 5/Bag	BI	5	60	\$38.11
975-41202001	5/8" OD Flare × 1/2" MIP, 1/Bag	BI	5	60	\$5.31
975-41203001	5/8" OD Flare × 3/4" MIP, 1/Bag	BI	5	20	\$5.93
<b>3/4" FLARE</b>					
975-40252501	3/4" OD Flare × 3/4" MIP, 1/Bag	BI	5	60	\$9.62



**Brass Flare Straight Adapters**

**FIP**

Item Number	Item Description	Pkg Type	Min Qty	Case Qty	Price
<b>1/4" FLARE</b>					
975-44020001	1/4" OD Flare × 1/8" FIP, 1/Bag	Bl	5	60	\$6.42
975-44020201	1/4" OD Flare × 1/4" FIP, 1/Bag	Bl	5	20	\$2.17
975-44021001	1/4" OD Flare × 3/8" FIP, 1/Bag	Bl	5	60	\$2.61
<b>5/16" FLARE</b>					
975-44050201	5/16" OD Flare × 1/4" FIP, 1/Bag	Bl	5	60	\$4.60
<b>3/8" FLARE</b>					
975-44101601	3/8" OD Flare × 3/8" FIP, 1/Bag	Bl	5	60	\$3.50
975-44102501	3/8" OD Flare × 3/4" FIP, 1/Bag	Bl	5	60	\$6.55
975-45101001	3/8" OD Flare × 1/4" FIP, 1/Bag	Bl	5	20	\$2.84
975-45102001	3/8" OD Flare × 1/2" FIP, 1/Bag	Bl	10	120	\$4.42
<b>1/2" FLARE</b>					
975-44161001	1/2" OD Flare × 3/8" FIP, 1/Bag	Bl	5	40	\$3.57
975-44161005	1/2" OD Flare × 3/8" FIP, 5/Bag	Bl	5	60	\$31.23
975-44161605	1/2" OD Flare × 1/2" FIP, 5/Bag	Bl	5	60	\$25.31
975-44162001	1/2" OD Flare × 1/2" FIP, 1/Bag	Bl	5	60	\$4.51
975-44162501	1/2" OD Flare × 3/4" FIP, 1/Bag	Bl	5	60	\$6.65
<b>5/8" FLARE</b>					
975-442016	5/8" OD Flare × 1/2" FIP, 5/Bag	Bl	5	15	\$68.02
975-44202501	5/8" OD Flare × 3/4" FIP, 1/Bag	Bl	5	20	\$6.34
975-45202001	5/8" OD Flare × 1/2" FIP, 1/Bag	Bl	5	40	\$5.04
<b>3/4" FLARE</b>					
975-44252501	3/4" OD Flare × 3/4" FIP, 1/Bag	Bl	5	60	\$16.98



975-44020201



975-442016

**Brass Flare Elbow Adapters**

**MIP**

Item Number	Item Description	Pkg Type	Min Qty	Case Qty	Price
<b>1/4" FLARE</b>					
975-27020001	1/4" OD Flare × 1/8" MIP, 1/Bag	Bl	10	40	\$5.93
975-27020201	1/4" OD Flare × 1/4" MIP, 1/Bag	Bl	5	60	\$3.73
<b>3/8" FLARE</b>					
975-27100001	3/8" OD Flare × 1/8" MIP, 1/Bag	Bl	5	60	\$9.85
975-27100201	3/8" OD Flare × 1/4" MIP, 1/Bag	Bl	5	20	\$4.48
975-27101601	3/8" OD Flare × 3/8" MIP, 1/Bag	Bl	5	60	\$4.00
975-28102001	3/8" OD Flare × 1/2" MIP, 1/Bag	Bl	5	60	\$5.06
<b>1/2" FLARE</b>					
975-27161001	1/2" OD Flare × 3/8" MIP, 1/Bag	Bl	5	40	\$7.28
975-27162001	1/2" OD Flare × 1/2" MIP, 1/Bag	Bl	5	40	\$7.67
<b>5/8" FLARE</b>					
975-27201601	5/8" OD Flare × 1/2" MIP, 1/Bag	Bl	5	20	\$14.80



975-27101010

**Brass Flare Elbow Adapters**

**FIP**



975-31101601

Item Number	Item Description	Pkg Type	Min Qty	Case Qty	Price
<b>3/8" FLARE</b>					
975-31101001	3/8" OD Flare × 3/8" FIP, 1/Bag	BI	5	20	\$4.91
975-31101601	3/8" OD Flare × 1/2" FIP, 1/Bag	BI	5	60	\$4.91
<b>1/2" FLARE</b>					
975-31161001	1/2" OD Flare × 3/8" FIP, 1/Bag	BI	5	60	\$6.65
975-31161601	1/2" OD Flare × 1/2" FIP, 1/Bag	BI	5	20	\$6.97
<b>5/8" FLARE</b>					
975-31201601	5/8" OD Flare × 1/2" FIP, 1/Bag	BI	5	60	\$13.09
975-31202501	5/8" OD Flare × 3/4" FIP, 1/Bag	BI	5	20	\$14.10

**Brass Flare Caps**

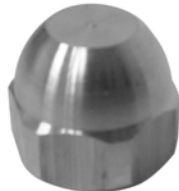

975-490201

Item Number	Item Description	Pkg Type	Min Qty	Case Qty	Price
975-490201	1/4" OD Flare, 1/Bag	BI	5	60	\$1.34
975-490501	5/16" OD Flare, 1/Bag	BI	5	60	\$3.64
975-491001	3/8" OD Flare, 1/Bag	BI	5	60	\$1.97
975-491601	1/2" OD Flare, 1/Bag	BI	5	60	\$2.73
975-492001	5/8" OD Flare, 1/Bag	BI	5	40	\$4.77

**Brass Flare Nuts**



975-080501



975-101001



975-091601

Item Number	Item Description	Pkg Type	Min Qty	Case Qty	Price
<b>SHORT ROD NUTS</b>					
975-080201	1/4" OD Flare, 1/Bag	BI	5	60	\$1.42
975-080501	5/16" OD Flare, 1/Bag	BI	5	60	\$2.16
975-081001	3/8" OD Flare, 1/Bag	BI	10	120	\$1.60
975-081010	3/8" OD Flare, 10/Bag	BI	5	60	\$15.65
975-081601	1/2" OD Flare, 1/Bag	BI	5	60	\$2.13
975-081610	1/2" OD Flare, 10/Bag	B	5	60	\$22.19
975-082001	5/8" OD Flare, 1/Bag	BI	5	60	\$3.23
975-082010	5/8" OD Flare, 10/Bag	BI	5	30	\$34.76
975-082501	3/4" OD Flare, 1/Bag	BI	5	60	\$9.84
975-083001	7/8" OD Flare, 1/Bag	BI	5	24	\$16.98
<b>LONG ROD NUTS</b>					
975-101001	3/8" OD Flare, 1/Bag	BI	10	120	\$3.52
975-101601	1/2" OD Flare, 1/Bag	BI	10	120	\$5.61
975-102001	5/8" OD Flare, 1/Bag	BI	10	120	\$9.22
<b>SHORT FORGED NUTS</b>					
975-091001	3/8" OD Flare, 1/Bag	BI	5	60	\$2.46
975-091601	1/2" OD Flare, 1/Bag	BI	5	60	\$3.23
975-091610	1/2" OD Flare, 10/Bag	BI	5	30	\$26.23
975-092001	5/8" OD Flare, 1/Bag	BI	5	60	\$4.78
975-092010	5/8" OD Flare, 10/Bag	B	5	30	\$33.73
975-093001	7/8" OD Flare, 1/Bag	BI	5	60	\$16.80

Supply

Drainage

Support

Specialties

Appendix

**Brass Flare Plugs**

Item Number	Item Description	Pkg Type	Min Qty	Case Qty	Price
975-510205	1/4" OD Flare, 1/Bag	BI	5	20	\$7.89
975-511005	3/8" OD Flare, 1/Bag	BI	5	60	\$3.61
975-511605	1/2" OD Flare, 1/Bag	BI	5	40	\$4.73
975-512005	5/8" OD Flare, 1/Bag	BI	5	20	\$9.21



975-510205

**Brass Fine Thread Flare Couplings**

Item Number	Item Description	Pkg Type	Min Qty	Case Qty	Price
978-12101001	3/8" OD Fine Thread Flare, 1/Bag	BI	5	20	\$5.93



978-12101001

**Brass Fine Thread Flare Tees**

Item Number	Item Description	Pkg Type	Min Qty	Case Qty	Price
978-201001	3/8" OD Fine Thread Flare, 1/Bag	BI	5	60	\$13.59

**Brass Fine Thread Flare Straight Adapters**

**MIP**

Item Number	Item Description	Pkg Type	Min Qty	Case Qty	Price
978-40101601	3/8" OD Fine Thread Flare × 3/8" MIP w/ 1/8" FIP Tap	BI	5	60	\$4.19
978-40102001	3/8" OD Fine Thread Flare × 1/2" MIP	BI	5	40	\$5.77



978-40101601

**Brass Fine Thread Flare Straight Adapters**

**FIP**

Item Number	Item Description	Pkg Type	Min Qty	Case Qty	Price
978-44101001	3/8" OD Fine Thread Flare × 3/8" FIP	BI	5	60	\$3.72
978-44101601	3/8" OD Fine Thread Flare × 1/2" FIP	BI	5	60	\$4.12



978-44101001

**Brass Fine Thread Flare Elbow Adapters**

**MIP**

Item Number	Item Description	Pkg Type	Min Qty	Case Qty	Price
978-27101605	3/8" Fine Thread Flare × 3/8" MIP, 5/Bag	BI	5	15	\$30.10

Supply

Drainage

Support

Specialties

Appendix



978-47021001

### Brass Fine Thread Flare Compression Adapters

Item Number	Item Description	Pkg Type	Min Qty	Case Qty	Price
978-47021001	3/8" Female Fine Thread Flare × 1/4" OD Comp, 1/Bag	BI	5	40	\$4.28
978-47101001	3/8" Female Fine Thread Flare × 3/8" OD Comp, 1/Bag	BI	5	60	\$5.93
978-47101601	1/2" Female Fine Thread Flare × 3/8" OD Comp, 1/Bag	BI	10	120	\$7.89



978-491001

### Brass Fine Thread Flare Caps

Item Number	Item Description	Pkg Type	Min Qty	Case Qty	Price
978-491001	3/8" OD Fine Thread Flare	BI	5	60	\$2.78

### Brass Fine Thread Flare Nut

Item Number	Item Description	Pkg Type	Min Qty	Case Qty	Price
978-081001	3/8" OD Fine Thread Flare, 1/Bag	BI	5	60	\$2.53

# Gas Specialty Fittings

**POL (LPG ) Gas Fittings**

**Gas Range Fittings**



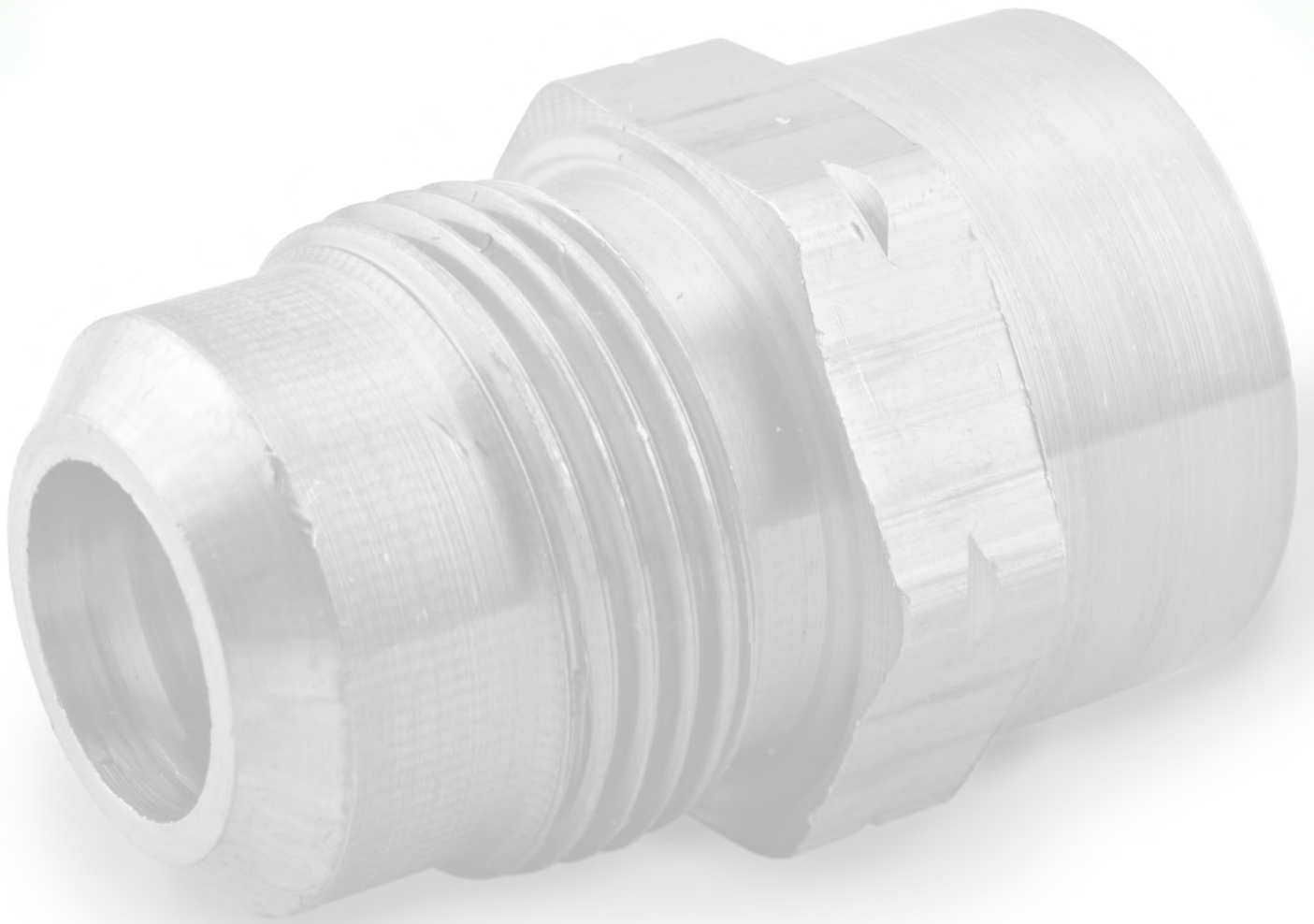

**POL (LPG) Gas Fittings**

Item Number	Item Description	Pkg Type	Min Qty	Case Qty	Price
979-400201	POL x MNPT, 1/4 OD Adapter	BI	5	60	\$10.84
979-491601	1/2" OD Cap	BI	5	60	\$14.04
979-590201	Tailpiece, 1/Bag	BI	5	60	\$15.93
979-600201	Nut And Tailpiece Kit, 1/Bag	BI	5	20	\$13.80
979-610201	Nut, 1/Bag	BI	5	60	\$4.32



979-400201

**Gas Range Fittings**

Item Number	Item Description	Pkg Type	Min Qty	Case Qty	Price
<b>FLARE X FLARE ADAPTER</b>					
958-44322001	5/8" OD Female Flare x 15/16" OD Male Flare, 100/Box	B	1	1	\$698.19
958-48322001	5/8" OD Female Flare x 15/16" OD Male Flare, 1/Bag	BI	5	60	\$7.71
<b>FLARE CAP</b>					
958-L493201	15/16" OD Flare, 1/Bag	BI	5	60	\$6.40



958-48322001

Supply

Drainage

Support

Specialties

Appendix





# **Bar Stock & Forged Fittings**

**Couplings, Reducing Couplings**

**Unions, Tees, Elbows**

**Straight Adapters**

**Caps, Hex Bushings**

**Face Bushings, Hex Nipples**

**Reducing Hex Nipples**

**Ball Valves, Locknuts**

**Plugs**



Supply

Drainage

Support

Specialties

Appendix

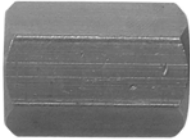

930-120201

### Bar-Stock Couplings

Item Number	Item Description	Pkg Type	Min Qty	Case Qty	Price
930-120201	1/8" FIP, 1/Bag	BI	5	60	\$1.52
930-121001	1/4" FIP, 1/Bag	BI	5	60	\$1.79
930-121601	3/8" FIP, 1/Bag	BI	5	60	\$2.72
930-121610	3/8" FIP, 10/Bag	BI	1	50	\$21.43
930-122001	1/2" FIP, 1/Bag	BI	5	60	\$4.19
930-122010	1/2" FIP, 10/Bag	BI	1	30	\$31.50
930-123001	3/4" FIP, 1/Bag	BI	5	60	\$4.70

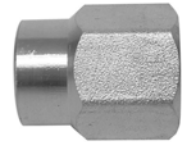

930-13100201

### Bar-Stock Reduced Couplings

Item Number	Item Description	Pkg Type	Min Qty	Case Qty	Price
930-13100201	1/4" FIP × 1/8" FIP, 1/Bag	BI	5	60	\$2.30
930-13160201	3/8" FIP × 1/8" FIP, 1/Bag	BI	5	20	\$4.26
930-13161001	3/8" FIP × 1/4" FIP, 1/Bag	BI	5	60	\$3.01
930-13200201	1/2" FIP × 1/8" FIP, 1/Bag	BI	5	20	\$10.93
930-13201001	1/2" FIP × 1/4" FIP, 1/Bag	BI	5	60	\$4.42
930-13201601	1/2" FIP × 3/8" FIP, 1/Bag	BI	5	60	\$3.96
930-13301601	3/4" FIP × 3/8" FIP, 1/Bag	BI	5	60	\$18.37
930-13302001	3/4" FIP × 1/2" FIP, 1/Bag	BI	5	60	\$7.56
930-13605001	1-1/2" FIP × 1-1/4" FIP, 1/Bag	BI	2	24	\$33.84

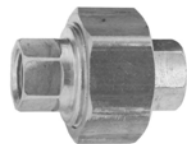

930-540201

### Bar-Stock Union Adapters

Item Number	Item Description	Pkg Type	Min Qty	Case Qty	Price
930-540201	1/8" FIP × 1/8" FIP, 1/Bag	BI	5	60	\$17.14
930-541001	1/4" FIP × 1/4" FIP, 1/Bag	BI	5	60	\$16.72
930-543001	3/4" FIP × 3/4" FIP, 1/Bag	BI	5	60	\$33.73
930-544001	1" FIP × 1" FIP, 1/Bag	BI	2	24	\$39.83



930-200201

### Bar-Stock Tees

Item Number	Item Description	Pkg Type	Min Qty	Case Qty	Price
<b>STANDARD TEE</b>					
930-200201	1/8" FIP, 1/Bag	BI	5	20	\$3.75
930-201001	1/4" FIP, 1/Bag	BI	5	60	\$3.74
930-201601	3/8" FIP, 1/Bag	BI	5	60	\$6.32
930-202001	1/2" FIP, 1/Bag	BI	5	60	\$9.53
930-203001	3/4" FIP, 1/Bag	BI	5	60	\$17.90
<b>REDUCING TEE</b>					
930-21161001	3/8" FIP × 3/8" FIP × 1/4" FIP, 1/Bag	BI	5	60	\$15.42
930-21201601	1/2" FIP × 1/2" FIP × 3/8" FIP, 1/Bag	BI	5	60	\$13.10

**Bar-Stock Elbows**

Item Number	Item Description	Pkg Type	Min Qty	Case Qty	Price
<b>90°</b>					
930-250201	1/8" FIP, 1/Bag	BI	5	20	\$2.62
930-251001	1/4" FIP, 1/Bag	BI	5	60	\$3.99
930-251601	3/8" FIP, 1/Bag	BI	5	40	\$5.22
930-252001	1/2" FIP, 1/Bag	BI	5	60	\$7.49
930-253001	3/4" FIP, 1/Bag	BI	5	40	\$15.50
930-257001	2" FIP, 1/Bag	BI	2	24	\$76.88



930-250201

**Bar-Stock Street Elbows**

Item Number	Item Description	Pkg Type	Min Qty	Case Qty	Price
<b>90° STREET</b>					
930-270201	1/8" MIP × 1/8" FIP, 1/Bag	BI	5	60	\$1.91
930-270210	1/8" MIP × 1/8" FIP, 10/Bag	BI	1	80	\$19.80
930-271001	1/4" MIP × 1/4" FIP, 1/Bag	BI	5	60	\$3.11
930-271010	1/4" MIP × 1/4" FIP, 10/Bag	BI	1	50	\$25.67
930-271601	3/8" MIP × 3/8" FIP, 1/Bag	BI	5	60	\$4.64
930-271610	3/8" MIP × 3/8" FIP, 10/Bag	BI	1	12	\$42.55
930-272001	1/2" MIP × 1/2" FIP, 1/Bag	BI	5	60	\$9.73
930-273001	3/4" MIP × 3/4" FIP, 1/Bag	BI	5	60	\$13.22
<b>45° STREET</b>					
930-380201	1/8" MIP × 1/8" FIP, 1/Bag	BI	5	60	\$9.42
930-381005	1/4" MIP × 1/4" FIP, 1/Bag	BI	5	60	\$18.54
930-381601	3/8" MIP × 3/8" FIP, 1/Bag	BI	5	60	\$23.52



930-270201

**Bar-Stock Straight Adapters**

**MIP × FIP**

Item Number	Item Description	Pkg Type	Min Qty	Case Qty	Price
930-56100201	1/4" FIP × 1/8" MIP, 1/Bag	BI	5	60	\$2.08
930-56161001	3/8" FIP × 1/4" MIP, 1/Bag	BI	5	60	\$3.16
930-56201601	1/2" FIP × 3/8" MIP, 1/Bag	BI	5	60	\$2.63

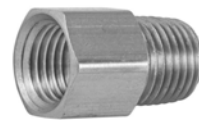

930-56100201

**Bar-Stock Caps**

Item Number	Item Description	Pkg Type	Min Qty	Case Qty	Price
930-490201	1/8" FIP, 1/Bag	BI	5	40	\$1.57
930-491001	1/4" FIP, 1/Bag	BI	5	60	\$1.48
930-491010	1/4" FIP, 10/Bag	BI	1	100	\$13.77
930-491601	3/8" FIP, 1/Bag	BI	5	60	\$2.24
930-491610	3/8" FIP, 10/Bag	BI	1	60	\$19.38
930-492001	1/2" FIP, 1/Bag	BI	5	60	\$3.02
930-493001	3/4" FIP, 1/Bag	BI	5	20	\$6.48
930-493010	3/4" FIP, 10/Bag	BI	1	25	\$64.88

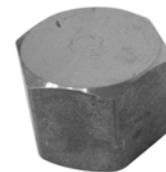

930-490210

Supply

Drainage

Support

Specialties

Appendix



932-15201601

### Bar-Stock Hex Bushings

Item Number	Item Description	Pkg Type	Min Qty	Case Qty	Price
930-15100201	1/4" MIP x 1/8" FIP, 1/Bag	BI	5	60	\$1.62
930-15100210	1/4" MIP x 1/8" FIP, 10/Bag	BI	1	150	\$11.49
930-15160201	3/8" MIP x 1/8" FIP, 1/Bag	BI	5	40	\$2.01
930-15160210	3/8" MIP x 1/8" FIP, 10/Bag	BI	1	100	\$16.46
930-15161001	3/8" MIP x 1/4" FIP, 1/Bag	BI	5	60	\$2.01
930-15161010	3/8" MIP x 1/4" FIP, 10/Bag	BI	1	100	\$15.26
930-15200201	1/2" MIP x 1/8" FIP, 1/Bag	BI	5	60	\$3.30
930-15201001	1/2" MIP x 1/4" FIP, 1/Bag	BI	5	60	\$2.84
930-15201601	1/2" MIP x 3/8" FIP, 1/Bag	BI	5	60	\$2.39
930-15201610	1/2" MIP x 3/8" FIP, 10/Bag	BI	1	60	\$21.78
930-15301001	3/4" MIP x 1/4" FIP, 1/Bag	BI	5	60	\$7.15
930-15301601	3/4" MIP x 3/8" FIP, 1/Bag	BI	5	60	\$4.76
930-15302001	3/4" MIP x 1/2" FIP, 1/Bag	BI	5	60	\$4.44
930-15403001	1" MIP x 3/4" FIP, 1/Bag	BI	2	24	\$8.52
<b>CHROME PLATED</b>					
932-15201601	1/2" MIP x 3/8" FIP, 1/Bag	BI	5	60	\$4.08
932-15302001	3/4" MIP x 1/2" FIP, 1/Bag	BI	5	60	\$5.38

### Bar-Stock Face Bushings



930-16161001

Item Number	Item Description	Pkg Type	Min Qty	Case Qty	Price
930-16161001	3/8" MIP x 1/4" FIP, 1/Bag	BI	5	60	\$3.61
930-16201601	1/2" MIP x 3/8" FIP, 1/Bag	BI	5	60	\$2.18
930-16302001	3/4" MIP x 1/2" FIP, 1/Bag	BI	5	60	\$4.45

### Bar-Stock Hex Nipples



930-610201

Item Number	Item Description	Pkg Type	Min Qty	Case Qty	Price
930-610201	1/8" MIP x 1/8" MIP, 1/Bag	BI	5	60	\$1.96
930-611001	1/4" MIP x 1/4" MIP, 1/Bag	BI	5	60	\$2.03
930-611601	3/8" MIP x 3/8" MIP, 1/Bag	BI	5	60	\$2.36
930-611610	3/8" MIP x 3/8" MIP, 10/Bag	BI	1	60	\$20.41
930-612001	1/2" MIP x 1/2" MIP, 1/Bag	BI	5	60	\$3.21
930-613001	3/4" MIP x 3/4" MIP, 1/Bag	BI	5	60	\$5.78

### Reducing Hex Nipples



930-62201001

Item Number	Item Description	Pkg Type	Min Qty	Case Qty	Price
930-62100201	1/4" MIP x 1/8" MIP, 1/Bag	BI	5	60	\$7.35
930-62161001	3/8" MIP x 1/4" MIP, 1/Bag	BI	5	60	\$9.13
930-62201001	1/2" MIP x 1/4" MIP, 1/Bag	BI	5	60	\$4.18
930-62201601	1/2" MIP x 3/8" MIP, 1/Bag	BI	5	60	\$4.57
930-62302001	3/4" MIP x 1/2" MIP, 1/Bag	BI	5	60	\$5.17

**Bar-Stock Ball Valves**

Item Number	Item Description	Pkg Type	Min Qty	Case Qty	Price
996-L100201	1/8" FIP x 1/8" FIP, Leaded, 1/Bag	Bl	5	60	\$41.03
996-L101001	1/4" FIP x 1/4" FIP, Leaded 1/Bag	Bl	5	60	\$41.33



996-L101001

**Bar-Stock Locknuts**

Item Number	Item Description	Pkg Type	Min Qty	Case Qty	Price
930-641001	1/4" FIP, 1/Bag	Bl	5	60	\$2.10
930-641601	3/8" FIP, 1/Bag	Bl	5	60	\$2.24
930-642001	1/2" FIP, 1/Bag	Bl	5	20	\$3.15
930-643001	3/4" FIP, 1/Bag	Bl	5	60	\$8.17



930-641001

**Bar-Stock Plugs**

Item Number	Item Description	Pkg Type	Min Qty	Case Qty	Price
<b>SQUARE-HEAD</b>					
930-500201	1/8" MIP, 1/Bag	Bl	5	60	\$1.37
930-501001	1/4" MIP, 1/Bag	Bl	5	60	\$1.64
930-501010	1/4" MIP, 10/Bag	Bl	1	150	\$10.29
930-501601	3/8" MIP, 1/Bag	Bl	5	60	\$1.90
930-502001	1/2" MIP, 1/Bag	Bl	5	60	\$2.74
930-502010	1/2" MIP, 10/Bag	Bl	1	45	\$25.13
930-503001	3/4" MIP, 1/Bag	Bl	5	60	\$4.18
930-504001	1" MIP, 1/Bag	Bl	2	24	\$9.67
930-506001	1-1/2" MIP, 1/Bag	Bl	2	24	\$24.11
<b>HEX-HEAD</b>					
930-510201	1/8" MIP, 1/Bag	Bl	5	60	\$2.30
930-511001	1/4" MIP, 1/Bag	Bl	5	60	\$1.87
930-511601	3/8" MIP, 1/Bag	Bl	5	60	\$2.29
930-512001	1/2" MIP, 1/Bag	Bl	5	60	\$4.00
930-513001	3/4" MIP, 1/Bag	Bl	5	60	\$7.00
<b>ALLEN-HEAD PLUGS</b>					
930-521001	1/4" MIP, 1/Bag	Bl	5	60	\$1.78
930-522001	1/2" MIP, 1/Bag	Bl	5	60	\$3.40
<b>SLOTTED</b>					
930-530201	1/8" MIP, 1/Bag	Bl	5	40	\$4.82



930-501001



930-512001



930-521001



930-530201



# Cast Brass Fittings

**Couplings, Reducing Couplings**

**Union Adapters**

**Tees, Elbows**

**Straight Adapters**

**Caps, Hex Bushings**

**Hex Nipples**

**Locknuts**

**Plugs**





**931-122001**  
Page 705



**931-13100201**  
Page 705



**931-541601**  
Page 705



**931-202001**  
Page 706



**931-252001**  
Page 706



**931-272001**  
Page 706



**931-562001**  
Page 707



**931-15200201**  
Page 707



**931-613001**  
Page 707



**931-642001**  
Page 708



**931-503001**  
Page 708



**Cast Red Brass Couplings**

Item Number	Item Description	Pkg Type	Min Qty	Case Qty	Price
931-122001	1/2" FIP, 1/Bag	Bl	5	60	\$7.57
931-123001	3/4" FIP, 1/Bag	Bl	5	60	\$11.73
931-124001	1" FIP, 1/Bag	Bl	2	24	\$15.07
931-125001	1-1/4" FIP, 1/Bag	Bl	2	24	\$29.98
931-126001	1-1/2" FIP, 1/Bag	Bl	2	24	\$38.31
931-127001	2" FIP, 1/Bag	Bl	2	24	\$65.95



931-122001

**Cast Red Brass Reducing Couplings**

Item Number	Item Description	Pkg Type	Min Qty	Case Qty	Price
931-13100201	1/4" FIP x 1/8" FIP, 1/Bag	Bl	5	60	\$8.27
931-13160201	3/8" FIP x 1/8" FIP, 1/Bag	Bl	5	20	\$8.27
931-13161001	3/8" FIP x 1/4" FIP, 1/Bag	Bl	5	60	\$5.80
931-13200201	1/2" FIP x 1/8" FIP, 1/Bag	Bl	5	60	\$7.00
931-13201001	1/2" FIP x 1/4" FIP, 1/Bag	Bl	5	60	\$7.07
931-13201601	1/2" FIP x 3/8" FIP, 1/Bag	Bl	5	60	\$7.21
931-13302001	3/4" FIP x 1/2" FIP, 1/Bag	Bl	5	60	\$10.25
931-13402001	1" FIP x 1/2" FIP, 1/Bag	Bl	2	24	\$17.46
931-13403001	1" FIP x 3/4" FIP, 1/Bag	Bl	2	24	\$16.70
931-13503001	1-1/4" FIP x 3/4" FIP, 1/Bag	Bl	2	24	\$29.19
931-13504001	1-1/4" FIP x 1" FIP, 1/Bag	Bl	2	24	\$28.93
931-13604001	1-1/2" FIP x 1" FIP, 1/Bag	Bl	2	24	\$33.31
931-13705001	2" FIP x 1-1/4" FIP, 1/Bag	Bl	2	24	\$51.32
931-13706001	2" FIP x 1-1/2" FIP, 1/Bag	Bl	2	24	\$56.45



931-13100201

**Cast Red Brass Union Adapters**

Item Number	Item Description	Pkg Type	Min Qty	Case Qty	Price
931-541601	3/8" FIP, 1/Bag	Bl	5	60	\$38.61
931-542001	1/2" FIP, 1/Bag	Bl	5	60	\$24.06
931-543001	3/4" FIP, 1/Bag	Bl	5	60	\$28.17
931-544001	1" FIP, 1/Bag	Bl	2	24	\$44.87
931-545001	1-1/4" FIP, 1/Bag	Bl	2	10	\$56.88
931-546001	1-1/2" FIP, 1/Bag	Bl	2	12	\$88.62
931-547001	2" FIP, 1/Bag	Bl	2	12	\$130.47



931-541601

Supply

Drainage

Support

Specialties

Appendix



931-207001

### Cast Red Brass Tees

Item Number	Item Description	Pkg Type	Min Qty	Case Qty	Price
931-181001	1/4" FIP, 1/Bag	BI	5	60	\$7.37
931-181601	3/8" FIP, 1/Bag	BI	5	60	\$8.90
931-200201	1/8" FIP, 1/Bag	BI	5	20	\$9.84
931-202001	1/2" FIP, 1/Bag	BI	5	60	\$10.87
931-203001	3/4" FIP, 1/Bag	BI	5	60	\$16.57
931-204001	1" FIP, 1/Bag	BI	2	24	\$27.61
931-205001	1-1/4" FIP, 1/Bag	BI	2	24	\$48.05
931-206001	1-1/2" FIP, 1/Bag	BI	2	12	\$78.43
931-207001	2" FIP, 1/Bag	BI	2	24	\$95.07



931-252001



931-370201

### Cast Red Brass Elbows

Item Number	Item Description	Pkg Type	Min Qty	Case Qty	Price
<b>90°</b>					
931-250201	1/8" FIP, 1/Bag	BI	5	20	\$8.10
931-251001	1/4" FIP, 1/Bag	BI	5	60	\$5.51
931-251601	3/8" FIP, 1/Bag	BI	5	40	\$8.08
931-252001	1/2" FIP, 1/Bag	BI	5	60	\$10.36
931-253001	3/4" FIP, 1/Bag	BI	5	60	\$14.16
931-254001	1" FIP, 1/Bag	BI	2	24	\$19.64
931-25500	1-1/4" FIP, 1/Bag	BI	2	24	\$38.57
931-256001	1-1/2" FIP, 1/Bag	BI	2	12	\$56.82
<b>45°</b>					
931-370201	1/8" FIP, 1/Bag	BI	5	20	\$8.02
931-371601	3/8" FIP, 1/Bag	BI	5	60	\$16.49
931-372001	1/2" FIP, 1/Bag	BI	5	60	\$9.68
931-373001	3/4" FIP, 1/Bag	BI	5	60	\$14.53
931-374001	1" FIP, 1/Bag	BI	5	20	\$23.73

### Cast Red Brass Street Elbows



931-272001



931-382001

Item Number	Item Description	Pkg Type	Min Qty	Case Qty	Price
<b>90° STREET</b>					
931-270201	1/8" MIP × 1/8" FIP, 1/Bag	BI	5	60	\$10.65
931-271001	1/4" MIP × 1/4" FIP, 1/Bag	BI	5	60	\$7.53
931-271601	3/8" MIP × 3/8" FIP, 1/Bag	BI	5	60	\$7.67
931-272001	1/2" MIP × 1/2" FIP, 1/Bag	BI	5	60	\$10.03
931-273001	3/4" MIP × 3/4" FIP, 1/Bag	BI	5	60	\$14.57
931-274001	1" MIP × 1" FIP, 1/Bag	BI	2	24	\$23.12
931-275001	1-1/4" MIP × 1-1/4" FIP, 1/Bag	BI	2	24	\$45.14
931-276001	1-1/2" MIP × 1-1/1" FIP, 1/Bag	BI	2	24	\$57.65
931-277001	2" MIP × 2" FIP, 1/Bag	BI	2	24	\$137.24
<b>45° STREET</b>					
931-382001	1/2" MIP × 1/2" FIP, 1/Bag	BI	5	60	\$9.49
931-383001	3/4" MIP × 3/4" FIP, 1/Bag	BI	5	60	\$14.00

**Cast Red Brass Straight Adapters**

**MIP × FIP**

Item Number	Item Description	Pkg Type	Min Qty	Case Qty	Price
931-56100201	1/4" FIP × 1/8" MIP, 1/Bag	Bl	5	60	\$14.44
931-56161001	3/8" FIP × 1/4" MIP, 1/Bag	Bl	5	60	\$14.71
931-562001	1/2" FIP × 1/2" MIP, 1/Bag	Bl	5	60	\$14.71



931-562001

**Cast Red Brass Caps**

Item Number	Item Description	Pkg Type	Min Qty	Case Qty	Price
931-490201	1/8" FIP, 1/Bag	Bl	5	40	\$5.78
931-491001	1/4" FIP, 1/Bag	Bl	5	60	\$8.92
931-491601	3/8" FIP, 1/Bag	Bl	5	60	\$6.20
931-492001	1/2" FIP, 1/Bag	Bl	5	60	\$7.02
931-493001	3/4" FIP, 1/Bag	Bl	5	60	\$8.99
931-494001	1" FIP, 1/Bag	Bl	2	24	\$17.05
931-495001	1-1/4" FIP, 1/Bag	Bl	2	24	\$22.90
931-496001	1-1/2" FIP, 1/Bag	Bl	2	24	\$32.49
931-497001	2" FIP, 1/Bag	Bl	2	24	\$54.05



931-491601

**Cast Red Brass Hex Bushings**

Item Number	Item Description	Pkg Type	Min Qty	Case Qty	Price
931-15100201	1/4" MIP × 1/8" FIP, 1/Bag	Bl	5	60	\$6.02
931-15160201	3/8" MIP × 1/8" FIP, 1/Bag	Bl	5	40	\$7.20
931-15161001	3/8" MIP × 1/4" FIP, 1/Bag	Bl	5	20	\$5.33
931-15200201	1/2" MIP × 1/8" FIP, 1/Bag	Bl	5	60	\$5.63
931-15201001	1/2" MIP × 1/4" FIP, 1/Bag	Bl	5	60	\$4.50
931-15201601	1/2" MIP × 3/8" FIP, 1/Bag	Bl	5	60	\$4.41
931-15302001	3/4" MIP × 1/2" FIP, 1/Bag	Bl	5	60	\$6.01
931-15402001	1" MIP × 1/2" FIP, 1/Bag	Bl	2	24	\$10.92
931-15503001	1-1/4" MIP × 3/4" FIP, 1/Bag	Bl	2	24	\$18.88
931-15504001	1-1/4" MIP × 1" FIP, 1/Bag	Bl	2	24	\$15.72
931-15604001	1-1/2" MIP × 1" FIP, 1/Bag	Bl	2	24	\$23.78
931-15605001	1-1/2" MIP × 1-1/4" FIP, 1/Bag	Bl	2	24	\$18.50
931-15705001	2" MIP × 1-1/4" FIP, 1/Bag	Bl	2	16	\$34.89
931-15706001	2" MIP × 1-1/2" FIP, 1/Bag	Bl	2	24	\$31.69



931-15200201

**Cast Red Brass Hex Nipples**

Item Number	Item Description	Pkg Type	Min Qty	Case Qty	Price
931-610201	1/8" MIP, 1/Bag	Bl	5	60	\$7.15
931-611001	1/4" MIP, 1/Bag	Bl	5	60	\$11.17
931-611601	3/8" MIP, 1/Bag	Bl	5	60	\$11.78
931-612001	1/2" MIP, 1/Bag	Bl	5	60	\$12.00
931-613001	3/4" MIP, 1/Bag	Bl	5	60	\$12.94



931-613001

Supply

Drainage

Support

Specialties

Appendix



931-641001

### Cast Red Brass Locknuts

Item Number	Item Description	Pkg Type	Min Qty	Case Qty	Price
931-640201	1/8" FIP, 1/Bag	BI	5	60	\$3.34
931-641001	1/4" FIP, 1/Bag	BI	5	60	\$3.37
931-641601	3/8" FIP, 1/Bag	BI	5	60	\$3.52
931-642001	1/2" FIP, 1/Bag	BI	5	60	\$5.16
931-643001	3/4" FIP, 1/Bag	BI	5	60	\$6.23



931-502001

### Cast Red Brass Plugs

Item Number	Item Description	Pkg Type	Min Qty	Case Qty	Price
<b>SQUARE-HEAD</b>					
931-501010	1/4" MIP, 1/Bag	BI	5	60	\$4.52
931-502001	1/2" MIP, 1/Bag	BI	5	60	\$5.60
931-503001	3/4" MIP, 1/Bag	BI	5	60	\$7.10
931-504001	1" MIP, 1/Bag	BI	5	20	\$9.61
931-505001	1-1/4" MIP, 1/Bag	BI	2	24	\$16.58
931-507001	2" MIP, 1/Bag	BI	2	24	\$31.19
<b>HEX-HEAD</b>					
931-510201	1/8" MIP, 1/Bag	BI	5	60	\$3.76
931-511001	1/4" MIP, 1/Bag	BI	5	60	\$2.10
931-511601	3/8" MIP, 1/Bag	BI	5	60	\$5.19
931-512001	1/2" MIP, 1/Bag	BI	5	60	\$9.23
931-513001	3/4" MIP, 1/Bag	BI	5	60	\$15.94



931-511001

# Nylon Thread Fittings

**Couplings**

**Bulkhead Union Adapters**

**Tees**

**Elbows**

**Hex Bushings**

**Hex Nipples**

**Plugs**

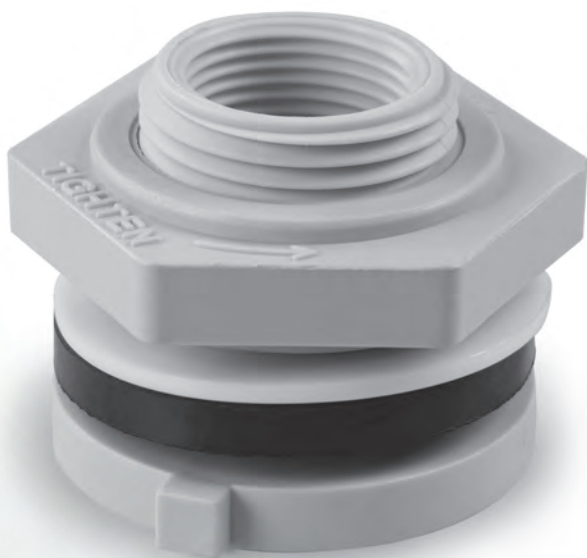

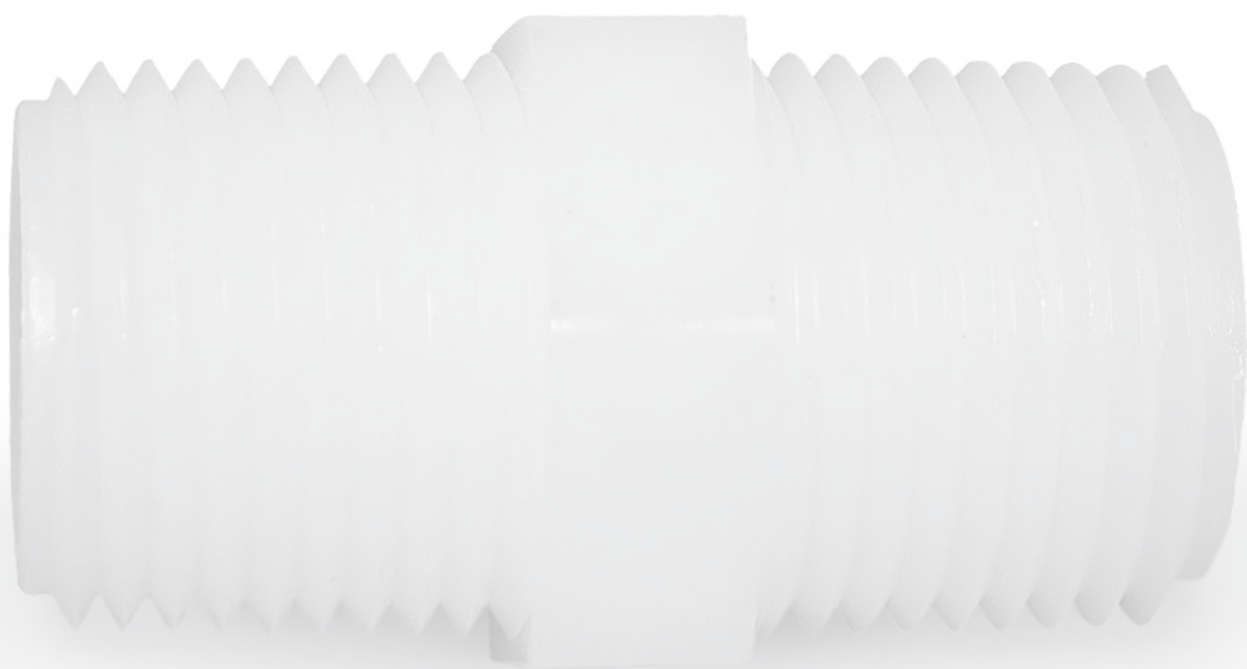

**Nylon Thread Couplings**

Item Number	Item Description	Pkg Type	Min Qty	Case Qty	Price
933-122001	1/2" FIP, 1/Bag	BI	5	60	\$5.79
933-123001	3/4" FIP, 1/Bag	BI	5	60	\$5.82
933-124001	1" FIP, 1/Bag	BI	5	60	\$6.78



933-122001

**Thread Bulkhead Union Adapters**

Item Number	Item Description	Pkg Type	Min Qty	Case Qty	Price
<b>NYLON</b>					
933-822001	1/2" FIP W/ Neoprene Washer, 1/Bag	BI	5	60	\$26.13
933-823001	3/4" FIP W/ Neoprene Washer, 1/Bag	BI	5	60	\$15.10
933-832001	1/2" FIP W/ Buna Washer, 1/Bag	BI	5	60	\$20.10
933-833001	3/4" FIP W/ Buna Washer, 1/Bag	BI	5	60	\$21.78
933-842001	1/2" FIP W/ EPDM Washer, 1/Bag	BI	5	60	\$12.20
933-843001	3/4" FIP W/ EPDM Washer, 1/Bag	BI	5	60	\$22.46
933-845001	1-1/4" FIP W/ EPDM Washer, 1/Bag	BI	1	2	\$31.48
<b>POLYPROPYLENE</b>					
933-8320P01	1/2" FIP W/ Buna Washer, 1/Bag	BI	5	60	\$22.79
933-8330P01	3/4" FIP W/ Buna Washer, 1/Bag	BI	5	60	\$24.47
933-8420P01	1/2" FIP W/ EPDM Washer, 1/Bag	BI	5	60	\$23.12
933-8430P01	3/4" FIP W/ EPDM Washer, 1/Bag	BI	5	60	\$24.79
933-8450P01	1-1/4" FIP W/ EPDM Washer, 1/Bag	BI	2	24	\$26.09
933-8460P01	1-1/2" FIP W/ EPDM Washer, 1/Bag	BI	2	24	\$78.74
933-8470P01	2" FIP W/ EPDM Washer, 1/Bag	BI	2	24	\$38.97



933-822001

**Barrel Valve Kits**

Item Number	Item Description	Pkg Type	Min Qty	Case Qty	Price
933-852001	1/2" FIP W/ Neoprene Washer, 1/Bag	BI	1	5	\$17.03
933-853001	3/4" FIP W/ Neoprene Washer, 1/Bag	BI	1	5	\$17.10



933-853001

**Nylon Thread Tees**

Item Number	Item Description	Pkg Type	Min Qty	Case Qty	Price
933-202001	1/2" FIP, 1/Bag	BI	5	60	\$7.44



933-202001

Supply

Drainage

Support

Specialties

Appendix



933-253001

### Nylon Thread Elbows

Item Number	Item Description	Pkg Type	Min Qty	Case Qty	Price
933-252001	1/2" FIP, 1/Bag	BI	5	60	\$6.20
933-253001	3/4" FIP, 1/Bag	BI	5	60	\$6.99
933-254001	1" FIP, 1/Bag	BI	2	24	\$12.11



933-15161001

### Nylon Thread Hex Bushings

Item Number	Item Description	Pkg Type	Min Qty	Case Qty	Price
933-15161001	3/8" MIP x 1/4" FIP, 1/Bag	BI	5	60	\$2.67
933-15201001	1/2" MIP x 1/4" FIP, 1/Bag	BI	5	60	\$2.32
933-15201601	1/2" MIP x 3/8" FIP, 1/Bag	BI	5	60	\$2.73
933-15301601	3/4" MIP x 3/8" FIP, 1/Bag	BI	5	60	\$2.87
933-15302001	3/4" MIP x 1/2" FIP, 1/Bag	BI	5	60	\$2.42
933-15402001	1" MIP x 1/2" FIP, 1/Bag	BI	2	24	\$3.31
933-15403001	1" MIP x 3/4" FIP, 1/Bag	BI	2	24	\$2.64
933-15503001	1-1/4" MIP x 3/4" FIP, 1/Bag	BI	2	24	\$5.42
933-15504001	1-1/4" MIP x 1" FIP, 1/Bag	BI	2	24	\$4.96
933-15604001	1-1/2" MIP x 1" FIP, 1/Bag	BI	2	24	\$5.74
933-15605001	1-1/2" MIP x 1-1/4" FIP, 1/Bag	BI	2	24	\$5.04



933-611001

### Nylon Thread Hex Nipples

Item Number	Item Description	Pkg Type	Min Qty	Case Qty	Price
933-611001	1/4" MIP, 1/Bag	BI	5	60	\$1.85
933-611601	3/8" MIP, 1/Bag	BI	5	60	\$1.39
933-612001	1/2" MIP, 1/Bag	BI	5	60	\$1.58
933-613001	3/4" MIP, 1/Bag	BI	5	60	\$1.79
933-614001	1" MIP, 1/Bag	BI	5	60	\$2.65



933-510201

### Nylon Thread Plugs

Item Number	Item Description	Pkg Type	Min Qty	Case Qty	Price
933-510201	1/8" MIP, 1/Bag	BI	5	60	\$1.49
933-511001	1/4" MIP, 1/Bag	BI	5	60	\$1.49
933-511601	3/8" MIP, 1/Bag	BI	5	60	\$1.42
933-512001	1/2" MIP, 1/Bag	BI	5	60	\$2.37
933-513001	3/4" MIP, 1/Bag	BI	5	60	\$1.62



# Pipe Nipples

**Yellow Brass**

**Chrome-Plated**

**Red Brass**





Pipe Nipples - Yellow Brass

Item Number	Item Description	Pkg Type	Min Qty	Case Qty	Price
<b>1/8" MIP</b>					
934-02001	Close, 1/Bag	Bl	5	60	\$2.87
934-021.501	1-1/2" Long, 1/Bag	Bl	5	60	\$2.04
934-022.501	2-1/2" Long, 1/Bag	Bl	5	60	\$3.34
934-02201	2" Long, 1/Bag	Bl	5	40	\$2.22
934-02401	4" Long, 1/Bag	Bl	5	20	\$4.84
934-02501	5" Long, 1/Bag	Bl	5	20	\$5.49
<b>1/4" MIP</b>					
934-10001	Close, 1/Bag	Bl	5	60	\$2.47
934-101.501	1-1/2" Long, 1/Bag	Bl	5	60	\$2.42
934-102.501	2-1/2" Long, 1/Bag	Bl	5	60	\$3.76
934-10201	2" Long, 1/Bag	Bl	5	60	\$3.01
934-103.505	3-1/2" Long, 1/Bag	Bl	5	60	\$7.85
934-10301	3" Long, 1/Bag	Bl	5	60	\$3.82
934-10401	4" Long, 1/Bag	Bl	5	60	\$5.80
934-10501	5" Long, 1/Bag	Bl	5	40	\$9.06
934-10601	6" Long, 1/Bag	Bl	5	30	\$10.39
<b>3/8" MIP</b>					
934-16001	Close, 1/Bag	Bl	5	60	\$2.44
934-161.501	1-1/2" Long, 1/Bag	Bl	5	60	\$3.13
934-162.501	2-1/2" Long, 1/Bag	Bl	5	20	\$4.70
934-16201	2" Long, 1/Bag	Bl	5	40	\$3.91
934-163.501	3-1/2" Long, 1/Bag	Bl	5	60	\$8.98
934-16301	3" Long, 1/Bag	Bl	5	20	\$6.06
934-16401	4" Long, 1/Bag	Bl	5	20	\$9.87
934-16501	5" Long, 1/Bag	Bl	5	60	\$11.74
934-16601	6" Long, 1/Bag	Bl	5	60	\$13.75
<b>1/2" MIP</b>					
934-20001	Close, 1/Bag	Bl	5	60	\$3.06
934-201.501	1-1/2" Long, 1/Bag	Bl	5	60	\$3.08
934-202.501	2-1/2" Long, 1/Bag	Bl	5	60	\$5.48
934-20201	2" Long, 1/Bag	Bl	5	60	\$4.59
934-203.501	3-1/2" Long, 1/Bag	Bl	5	60	\$7.20
934-20301	3" Long, 1/Bag	Bl	5	60	\$6.92
934-204.501	4-1/2" Long, 1/Bag	Bl	5	60	\$15.09
934-20401	4" Long, 1/Bag	Bl	5	60	\$13.08
934-205.501	5-1/2" Long, 1/Bag	Bl	5	60	\$18.09
934-20501	5" Long, 1/Bag	Bl	5	60	\$18.09
934-20601	6" Long, 1/Bag	Bl	5	60	\$20.43
<b>3/4" MIP</b>					
934-30001	Close, 1/Bag	Bl	5	60	\$4.13
934-301.501	1-1/2" Long, 1/Bag	Bl	5	60	\$7.71
934-302.501	2-1/2" Long, 1/Bag	Bl	5	60	\$13.87
934-30201	2" Long, 1/Bag	Bl	5	60	\$11.00
934-30301	3" Long, 1/Bag	Bl	5	60	\$18.09
934-30401	4" Long, 1/Bag	Bl	5	40	\$18.76
934-30501	5" Long, 1/Bag	Bl	5	60	\$26.13
934-30601	6" Long, 1/Bag	Bl	5	60	\$28.80



934-021.501



934-102.501



934-163.501

Supply

Drainage

Support

Specialties

Appendix

**Pipe Nipples - Yellow Brass (Cont)**



934-40201

Item Number	Item Description	Pkg Type	Min Qty	Case Qty	Price
<b>1" MIP</b>					
934-40001	Close, 1/Bag	BI	2	24	\$13.41
934-402.501	2-1/2" Long, 1/Bag	BI	2	24	\$23.12
934-40201	2" Long, 1/Bag	BI	2	24	\$18.09
934-40401	4" Long, 1/Bag	BI	2	24	\$26.48
<b>2" MIP</b>					
934-70401	4" Long, 1/Bag	BI	2	24	\$68.36

**Pipe Nipples - Chrome-Plated Yellow Brass**



936-16201



936-20201

Item Number	Item Description	Pkg Type	Min Qty	Case Qty	Price
<b>3/8" MIP</b>					
936-16001	Close, 1/Bag	BI	5	60	\$8.29
936-162.501	2-1/2" Long, 1/Bag	BI	5	60	\$12.61
936-16201	2" Long, 1/Bag	BI	5	60	\$11.64
936-163.501	3-1/2" Long, 1/Bag	BI	5	60	\$16.40
936-16301	3" Long, 1/Bag	BI	5	60	\$15.24
936-16401	4" Long, 1/Bag	BI	5	60	\$19.38
936-16501	5" Long, 1/Bag	BI	5	60	\$22.53
936-16601	6" Long, 1/Bag	BI	5	60	\$26.36
<b>1/2" MIP</b>					
936-20001	Close, 1/Bag	BI	5	60	\$10.88
936-201.501	1-1/2" Long, 1/Bag	BI	5	60	\$12.48
936-20201	2" Long, 1/Bag	BI	5	60	\$14.53
936-203.501	3-1/2" Long, 1/Bag	BI	5	60	\$22.77
936-20301	3" Long, 1/Bag	BI	5	60	\$20.04
936-20401	4" Long, 1/Bag	BI	5	60	\$20.56
936-20501	5" Long, 1/Bag	BI	5	60	\$30.96
936-20601	6" Long, 1/Bag	BI	5	60	\$37.55

**Pipe Nipples - Red Brass**



935-201.501

Item Number	Item Description	Pkg Type	Min Qty	Case Qty	Price
<b>1/8" MIP</b>					
935-02001	Close, 1/Bag	BI	5	60	\$3.91
935-021.501	1-1/2" Long, 1/Bag	BI	5	60	\$4.32
935-022.501	2-1/2" Long, 1/Bag	BI	5	20	\$5.27
935-02201	2" Long, 1/Bag	BI	5	40	\$4.60
935-02301	3" Long, 1/Bag	BI	5	20	\$5.74
935-02401	4" Long, 1/Bag	BI	5	20	\$6.72
935-02501	5" Long, 1/Bag	BI	5	60	\$7.93
935-02601	6" Long, 1/Bag	BI	5	60	\$9.96

Supply

Drainage

Support

Specialties

Appendix

**Pipe Nipples - Red Brass (Cont)**

Item Number	Item Description	Pkg Type	Min Qty	Case Qty	Price
<b>1/4" MIP</b>					
935-10001	Close, 1/Bag	Bl	5	60	\$4.46
935-101.501	1-1/2" Long, 1/Bag	Bl	5	60	\$5.05
935-102.501	2-1/2" Long, 1/Bag	Bl	5	60	\$6.04
935-10201	2" Long, 1/Bag	Bl	5	60	\$5.62
935-10301	3" Long, 1/Bag	Bl	5	60	\$7.52
935-10401	4" Long, 1/Bag	Bl	5	60	\$8.72
935-10501	5" Long, 1/Bag	Bl	5	40	\$10.21
935-10601	6" Long, 1/Bag	Bl	5	60	\$12.29
<b>3/8" MIP</b>					
935-16001	Close, 1/Bag	Bl	5	60	\$4.60
935-161.501	1-1/2" Long, 1/Bag	Bl	5	60	\$5.32
935-162.501	2-1/2" Long, 1/Bag	Bl	5	20	\$7.37
935-16201	2" Long, 1/Bag	Bl	5	40	\$6.71
935-16301	3" Long, 1/Bag	Bl	5	20	\$8.12
935-16501	5" Long, 1/Bag	Bl	5	60	\$12.33
935-16601	6" Long, 1/Bag	Bl	5	60	\$14.80
<b>1/2" MIP</b>					
935-20001	Close, 1/Bag	Bl	5	60	\$6.11
935-201.501	1-1/2" Long, 1/Bag	Bl	5	60	\$7.11
935-202.501	2-1/2" Long, 1/Bag	Bl	5	60	\$9.66
935-20201	2" Long, 1/Bag	Bl	5	60	\$8.54
935-20301	3" Long, 1/Bag	Bl	5	60	\$11.63
935-20401	4" Long, 1/Bag	Bl	5	60	\$14.05
935-20501	5" Long, 1/Bag	Bl	5	60	\$16.16
935-20601	6" Long, 1/Bag	Bl	5	60	\$21.32
<b>3/4" MIP</b>					
935-30001	Close, 1/Bag	Bl	5	60	\$8.20
935-301.501	1-1/2" Long, 1/Bag	Bl	5	60	\$8.70
935-302.501	2-1/2" Long, 1/Bag	Bl	5	60	\$11.64
935-30201	2" Long, 1/Bag	Bl	5	60	\$10.75
935-303.501	3-1/2" Long, 1/Bag	Bl	5	60	\$18.25
935-30301	3" Long, 1/Bag	Bl	5	60	\$14.68
935-304.501	4-1/2" Long, 1/Bag	Bl	5	60	\$22.65
935-30401	4" Long, 1/Bag	Bl	5	60	\$14.90
935-305.501	5-1/2" Long, 1/Bag	Bl	5	60	\$33.04
935-30501	5" Long, 1/Bag	Bl	5	60	\$20.54
935-30601	6" Long, 1/Bag	Bl	5	60	\$24.83
<b>1" MIP</b>					
935-40001	Close, 1/Bag	Bl	2	24	\$11.78
935-40201	2" Long, 1/Bag	Bl	2	24	\$14.79
935-40301	3" Long, 1/Bag	Bl	2	24	\$20.59
935-40601	6" Long, 1/Bag	Bl	2	24	\$35.96
<b>1-1/4" MIP</b>					
935-50001	Close, 1/Bag	Bl	2	24	\$17.41
935-50301	3" Long, 1/Bag	Bl	2	24	\$29.18
935-50401	4" Long, 1/Bag	Bl	2	24	\$35.42
935-50601	6" Long, 1/Bag	Bl	2	24	\$49.88



935-40201



935-50401

Supply

Drainage

Support

Specialties

Appendix

**Pipe Nipples - Red Brass (Cont)**



935-70301

Item Number	Item Description	Pkg Type	Min Qty	Case Qty	Price
<b>1-1/2" MIP</b>					
935-60001	Close, 1/Bag	BI	2	24	\$22.47
935-60301	3" Long, 1/Bag	BI	2	24	\$36.54
935-60601	6" Long, 1/Bag	BI	2	24	\$72.18
<b>2" MIP</b>					
935-70001	Close, 1/Bag	BI	2	24	\$33.86
935-70301	3" Long, 1/Bag	BI	2	24	\$42.00
935-70401	4" Long, 1/Bag	BI	2	24	\$60.22
935-70601	6" Long, 1/Bag	BI	2	24	\$86.11

Supply

Drainage

Support

Specialties

Appendix

# Polypro Push Fittings

**Couplings**

**Elbows**

**Tees**

**Straight Adapters**

**Elbow Adapters**

**Valves**



Polypro push fittings offer a fast, easy connection for copper, polyethylene, and PEX tubing in cold-water applications.

**Note:** Do Not expose polypro push fittings to volatile organic compounds (VOCs) or caustic chemicals. Do Not use with vinly tubing.





**Polypropylene Push-Fit Couplings**

- For use with copper, polyethylene, and PEX tubing.
- For cold-water applications only. Do Not use with vinyl tube.

Item Number	Item Description	Pkg Type	Min Qty	Case Qty	Price
645QK0	1/4" OD PF, 1/Bag	BI	5	60	\$3.57
645QK1	3/8" OD PF, 1/Bag	BI	5	60	\$5.72
645QK2	1/2" OD PF, 1/Bag	BI	5	60	\$6.46
645QK9	5/16" OD PF, 1/Bag	BI	5	60	\$6.46
<b>REDUCING</b>					
645QK10	3/8 OD PF × 1/4" OD PF, 1/Bag	BI	5	60	\$5.72
645QK90	5/16" OD PF × 1/4" OD PF, 1/Bag	BI	5	60	\$6.46



645QK1

**Polypropylene Push-Fit Elbows**

- For use with copper, polyethylene, and PEX tubing.
- For cold-water applications only. Do Not use with vinyl tube.

Item Number	Item Description	Pkg Type	Min Qty	Case Qty	Price
642QK0	1/4" OD PF, 1/Bag	BI	5	60	\$3.44
642QK1	3/8" PF, 1/Bag	BI	5	60	\$3.63



642QK1

**Polypropylene Push-Fit Tees**

- For use with copper, polyethylene, and PEX tubing.
- For cold-water applications only. Do Not use with vinyl tube.

Item Number	Item Description	Pkg Type	Min Qty	Case Qty	Price
641QK000	1/4" OD PF, 1/Bag	BI	5	60	\$6.39
641QK111	3/8" OD PF, 1/Bag	BI	5	60	\$7.81
641QK222	1/2" OD PF, 1/Bag	BI	5	60	\$9.23



641QK222



646QK2

### Polypropylene Push-Fit Straight Adapters

- For use with copper, polyethylene, and PEX tubing.
- For cold-water applications only. Do Not use with vinyl tube.

Item Number	Item Description	Pkg Type	Min Qty	Case Qty	Price
<b>MIP</b>					
646QK0	1/4" OD PF × 1/4 MIP, 1/Bag	BI	5	60	\$3.05
646QK01	3/8" OD PF × 1/4 MIP, 1/Bag	BI	5	60	\$3.18
646QK1	3/8" OD PF × 3/8" MIP, 1/Bag	BI	5	60	\$3.35
646QK10	1/4" OD PF × 3/8" MIP, 1/Bag	BI	5	60	\$3.35
646QK12	1/2" OD PF × 3/8" MIP, 1/Bag	BI	5	60	\$4.46
646QK2	1/2" OD PF × 1/2" MIP, 1/Bag	BI	5	60	\$4.46
646QK20	1/4" OD PF × 1/2" MIP, 1/Bag	BI	5	60	\$4.09
646QK21	3/8" OD PF × 1/2" MIP, 1/Bag	BI	5	60	\$4.09
646QK80	1/4" OD PF × 1/8" MIP, 1/Bag	BI	5	60	\$3.72
646QK81	3/8" OD PF × 1/8" MIP, 1/Bag	BI	5	60	\$5.59
<b>FIP</b>					
647QK0	1/4" OD PF × 1/4" FIP, 1/Bag	BI	5	60	\$5.23
647QK10	3/8" OD PF × 1/4" FIP, 1/Bag	BI	5	60	\$5.23

### Polypropylene Push-Fit Elbow Adapters

#### MIP



632QK221M

- For use with copper, polyethylene, and PEX tubing.
- For cold-water applications only. Do Not use with vinyl tube.

Item Number	Item Description	Pkg Type	Min Qty	Case Qty	Price
632QK000M	1/4" OD PF × 1/4 MIP, 1/Bag	BI	5	60	\$4.81
632QK002M	1/4" OD PF × 1/2" MIP, 1/Bag	BI	5	60	\$5.09
632QK110M	3/8" OD PF × 1/4 MIP, 1/Bag	BI	5	60	\$5.65
632QK111M	3/8" OD PF × 3/8" MIP, 1/Bag	BI	5	60	\$7.06
632QK221M	1/2" OD PF × 3/8" MIP, 1/Bag	BI	5	60	\$7.06
632QK222M	1/2" OD PF × 1/2" MIP, 1/Bag	BI	5	60	\$7.06

### Polypropylene Push-Fit Valves



637QK980M

- For use with copper, polyethylene, and PEX tubing.
- For cold-water applications only. Do Not use with vinyl tube.

Item Number	Item Description	Pkg Type	Min Qty	Case Qty	Price
<b>PF × PF</b>					
637QK900	1/4" OD PF × 1/4" OD PF, 1/Bag	BI	5	60	\$14.14
637QK911	3/8" OD PF × 3/8" OD PF, 1/Bag	BI	5	60	\$14.93
<b>PF × MIP</b>					
637QK911M	3/8" OD PF × 3/8" MIP, 1/Bag	BI	5	60	\$13.99
637QK980M	1/4" OD PF × 1/8" MIP, 1/Bag	BI	5	60	\$13.24

# **Brass Hose Barb Fittings**

**Couplings**

**Elbows**

**Straight Adapters**

**Ferrules**

**Valves**



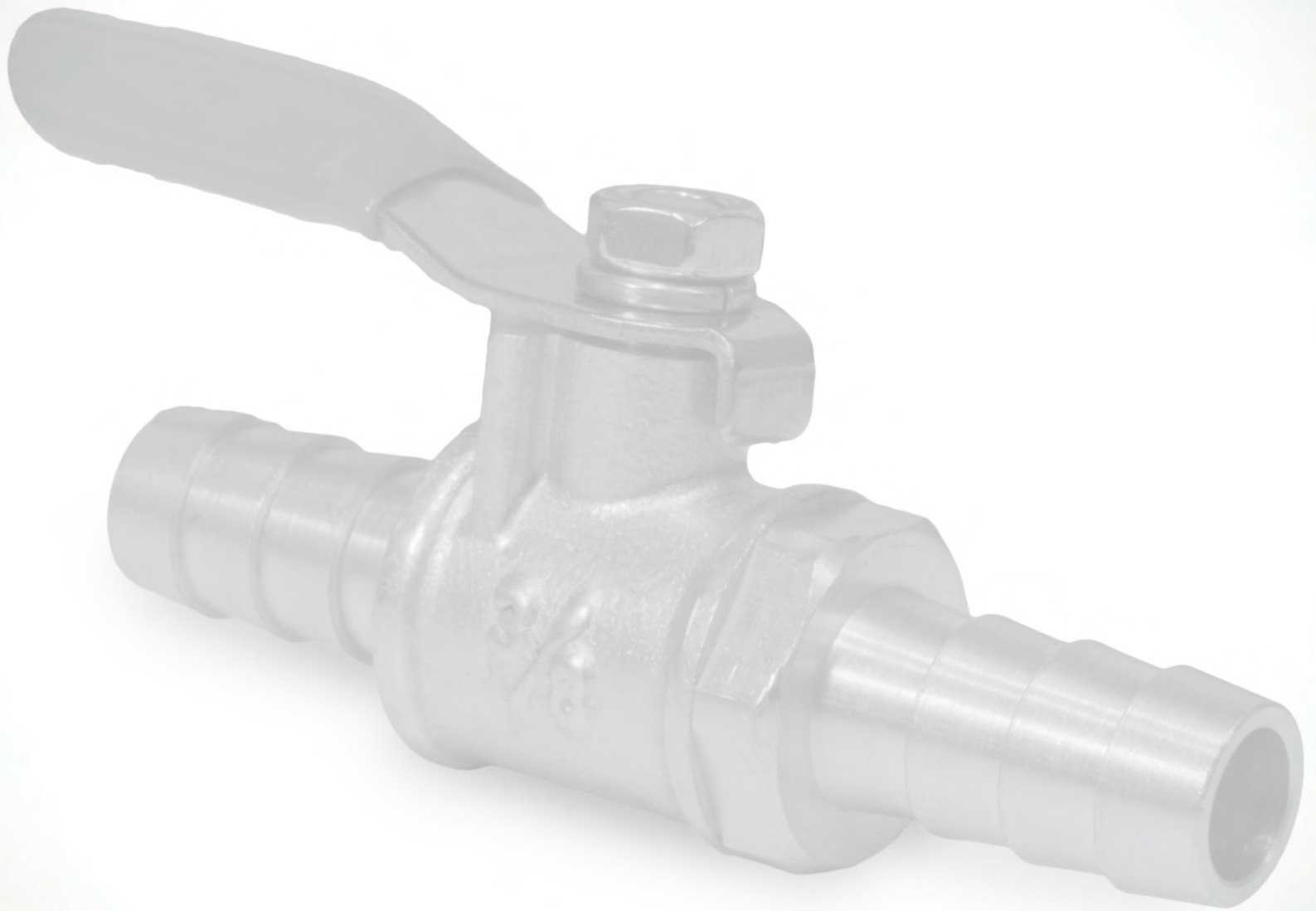

**Brass Hose Barb Couplings**

Item Number	Item Description	Pkg Type	Min Qty	Case Qty	Price
903-120201	1/8" Barb, 1/Bag	Bl	5	60	\$1.99
903-120501	3/16" Barb, 1/Bag	Bl	5	60	\$2.10
903-121001	1/4" Barb, 1/Bag	Bl	5	60	\$1.86
903-121501	5/16" Barb, 1/Bag	Bl	5	60	\$2.04
903-121601	3/8" Barb, 1/Bag	Bl	5	60	\$2.13
903-122001	1/2" Barb, 1/Bag	Bl	5	60	\$2.42
903-122501	5/8" Barb, 1/Bag	Bl	5	40	\$4.03
903-123001	3/4" Barb, 1/Bag	Bl	5	60	\$3.65
903-123301	7/8" Barb, 1/Bag	Bl	5	60	\$6.94



903-122001

**Brass Hose Barb Elbows**

Item Number	Item Description	Pkg Type	Min Qty	Case Qty	Price
903-26162001	3/8" Barb x 1/2" MIP, 1/Bag	Bl	5	60	\$4.97
903-671601	3/8" Barb x 3/8" MIP, 1/Bag	Bl	5	60	\$3.76



903-26162001

**Brass Hose Barb Straight Adapters**

**MIP**

Item Number	Item Description	Pkg Type	Min Qty	Case Qty	Price
<b>1/8" BARB</b>					
903-400201	1/8" Barb x 1/8" MIP, 1/Bag	Bl	5	60	\$1.70
903-41021001	1/8" Barb x 1/4" MIP, 1/Bag	Bl	5	60	\$4.67
<b>3/16" BARB</b>					
903-41050201	3/16" Barb x 1/8" MIP, 1/Bag	Bl	5	60	\$2.68
903-41051001	3/16" Barb x 1/4" MIP, 1/Bag	Bl	5	60	\$2.02
<b>1/4" BARB</b>					
903-401001	1/4" Barb x 1/4" MIP, 1/Bag	Bl	5	60	\$2.20
903-41100201	1/4" Barb x 1/8" MIP, 1/Bag	Bl	5	60	\$2.53
903-41101601	1/4" Barb x 3/8" MIP, 1/Bag	Bl	5	60	\$2.75
903-41102001	1/4" Barb x 1/2" MIP, 1/Bag	Bl	5	60	\$3.99
<b>5/16" BARB</b>					
903-41150201	5/16" Barb x 1/8" MIP, 1/Bag	Bl	5	60	\$2.12
903-41151001	5/16" Barb x 1/4" MIP, 1/Bag	Bl	5	60	\$2.73
903-41151601	5/16" Barb x 3/8" MIP, 1/Bag	Bl	5	60	\$4.60
<b>3/8" BARB</b>					
903-401601	3/8" Barb x 3/8" MIP, 1/Bag	Bl	5	60	\$3.10
903-41161001	3/8" Barb x 1/4" MIP, 1/Bag	Bl	5	60	\$2.77
903-41162001	3/8" Barb x 1/2" MIP, 1/Bag	Bl	5	60	\$3.94
<b>1/2" BARB</b>					
903-402001	1/2" Barb x 1/2" MIP, 1/Bag	Bl	5	60	\$4.70
903-41201001	1/2" Barb x 1/4" MIP, 1/Bag	Bl	5	60	\$3.64
903-41201601	1/2" Barb x 3/8" MIP, 1/Bag	Bl	5	60	\$3.95
903-41203001	1/2" Barb x 3/4" MIP, 1/Bag	Bl	5	60	\$6.22



903-401601

**Brass Hose Barb Straight Adapters (Cont)**

**MIP**

Item Number	Item Description	Pkg Type	Min Qty	Case Qty	Price
<b>5/8" BARB</b>					
903-41251601	5/8" Barb × 3/8" MIP, 1/Bag	BI	5	60	\$4.02
903-41252001	5/8" Barb × 1/2" MIP, 1/Bag	BI	5	60	\$5.11
903-41253001	5/8" Barb × 3/4" MIP, 1/Bag	BI	5	60	\$8.27
<b>3/4" BARB</b>					
903-403001	3/4" Barb × 3/4" MIP, 1/Bag	BI	5	60	\$6.37
903-41302001	3/4" Barb × 1/2" MIP, 1/Bag	BI	5	60	\$5.86
<b>1" BARB</b>					
903-404001	1" Barb × 1" MIP, 1/Bag	BI	5	60	\$12.03

**Brass Hose Barb Straight Adapters**

**FIP**

Item Number	Item Description	Pkg Type	Min Qty	Case Qty	Price
<b>1/8" BARB</b>					
903-440201	1/8" Barb × 1/8" FIP, 1/Bag	BI	5	60	\$3.98
903-45021001	1/8" Barb × 1/4" FIP, 1/Bag	BI	5	40	\$4.92
<b>3/16" BARB</b>					
903-45051001	3/16" Barb × 1/4" FIP, 1/Bag	BI	5	60	\$5.26
<b>1/4" BARB</b>					
903-441001	1/4" Barb × 1/4" FIP, 1/Bag	BI	5	60	\$3.66
903-45100201	1/4" Barb × 1/8" FIP, 1/Bag	BI	5	60	\$2.97
903-45101601	1/4" Barb × 3/8" FIP, 1/Bag	BI	5	60	\$3.13
<b>5/16" BARB</b>					
903-45151001	5/16" Barb × 1/4" FIP, 1/Bag	BI	5	60	\$2.98
<b>3/8" BARB</b>					
903-441601	3/8" Barb × 3/8" FIP, 1/Bag	BI	5	60	\$4.55
903-45161001	3/8" Barb × 1/4" FIP, 1/Bag	BI	5	60	\$2.89
903-45162001	3/8" Barb × 1/2" FIP, 1/Bag	BI	5	60	\$6.11
<b>1/2" BARB</b>					
903-442001	1/2" Barb × 1/2" FIP, 1/Bag	BI	5	60	\$4.07
903-45201601	1/2" Barb × 3/8" FIP, 1/Bag	BI	5	60	\$7.09
<b>3/8" BARB SWIVEL ADAPTER</b>					
903-461601	3/8" Barb × 3/8" FIP Swivel, 1/Bag	BI	5	60	\$5.47



903-442001



903-461601

Supply

Drainage

Support

Specialties

Appendix

**Brass Hose Barb Ferrule**

Item Number	Item Description	Pkg Type	Min Qty	Case Qty	Price
903-L99531	.531 I.D., Brass, 50/Bag	B	1	5	\$28.10
903-L99560	.562 I.D., Brass, 50/Bag	B	1	5	\$33.58
903-L99593	.593 I.D., Brass, 50/Bag	B	1	5	\$33.58
903-L99625	.625 I.D., Brass, 50/Bag	B	1	5	\$38.91
903-L99656	.656 I.D., Brass, 50/Bag	B	1	5	\$33.58
903-L99690	.687 I.D., Brass, 50/Bag	B	1	5	\$38.91
903-L99781	.781 I.D., Brass, 50/Bag	B	1	4	\$33.58
903-L99812	.812 I.D., Brass, 50/Bag	B	1	4	\$38.84



903-L99531

**Brass Hose Barb Valves**

Item Number	Item Description	Pkg Type	Min Qty	Case Qty	Price
<b>LEADED BRASS</b>					
996-L601001	1/4" x 1/4" Barb Ball Valve, Leaded, 1/Bag	Bl	5	60	\$39.74
996-L601601	3/8" x 3/8" Barb Ball Valve, Leaded, 1/Bag	Bl	5	60	\$43.38



996-L601601





# **Nylon Hose Barb Fittings**

**Couplings**

**Reducing Couplings**

**Elbows**

**Tees**

**Straight Adapters**

**Elbow Adapters**





**904-123001**  
Page 731



**904-13201601**  
Page 731



**904-25101**  
Page 731









**904-200201**  
Page 731



**904-41162001**  
Page 732



**904-271001**  
Page 733

 <b>904-123001</b> Page 731	 <b>904-13201601</b> Page 731	 <b>904-25101</b> Page 731	 <b>904-200201</b> Page 731	 <b>904-41162001</b> Page 732
 <b>904-271001</b> Page 733				

**Nylon Hose Barb Couplings**

Item Number	Item Description	Pkg Type	Min Qty	Case Qty	Price
904-120201	1/8" Barb, 1/Bag	Bl	5	60	\$2.08
904-120501	3/16" Barb, 1/Bag	Bl	5	60	\$1.56
904-121001	1/4" Barb, 1/Bag	Bl	5	60	\$1.63
904-121501	5/16" Barb, 1/Bag	Bl	5	60	\$1.61
904-121601	3/8" Barb, 1/Bag	Bl	5	60	\$1.34
904-122001	1/2" Barb, 1/Bag	Bl	5	60	\$1.40
904-122501	5/8" Barb, 1/Bag	Bl	5	60	\$1.56
904-123001	3/4" Barb, 1/Bag	Bl	5	60	\$1.98
904-124001	1" Barb, 1/Bag	Bl	5	60	\$2.54
904-125001	1-1/4" Barb, 1/Bag	Bl	2	24	\$4.10
904-126001	1-1/2" Barb, 1/Bag	Bl	2	24	\$4.32
904-127001	2" Barb, 1/Bag	Bl	1	4	\$14.57



904-125001

**Nylon Hose Barb Reducing Couplings**

Item Number	Item Description	Pkg Type	Min Qty	Case Qty	Price
904-13100501	1/4" x 3/16" Barb, 1/Bag	Bl	5	60	\$1.47
904-13161001	3/8" x 1/4" Barb, 1/Bag	Bl	5	60	\$1.46
904-13201601	1/2" x 3/8" Barb, 1/Bag	Bl	5	60	\$1.47
904-13252001	5/8" x 1/2" Barb, 1/Bag	Bl	5	60	\$1.74



904-13201601

**Nylon Hose Barb Elbows**

Item Number	Item Description	Pkg Type	Min Qty	Case Qty	Price
904-25101	1/4" Barb, 1/Bag	Bl	5	60	\$2.02
904-251601	3/8" Barb, 1/Bag	Bl	5	60	\$2.02
904-252001	1/2" Barb, 1/Bag	Bl	5	60	\$2.02
904-252501	5/8" Barb, 1/Bag	Bl	5	60	\$2.45
904-253001	3/4" Barb, 1/Bag	Bl	5	60	\$2.42
904-254001	1" Barb, 1/Bag	Bl	5	60	\$3.56
904-255001	1-1/4" Barb, 1/Bag	Bl	2	24	\$8.63



904-25101

**Nylon Hose Barb Tees**

Item Number	Item Description	Pkg Type	Min Qty	Case Qty	Price
<b>STANDARD TEE</b>					
904-200201	1/8" Barb, 1/Bag	Bl	5	60	\$2.17
904-200501	3/16" Barb, 1/Bag	Bl	5	60	\$2.00
904-201001	1/4" Barb, 1/Bag	Bl	5	60	\$2.16
904-201601	3/8" Barb, 1/Bag	Bl	5	60	\$1.95
904-202000	1/2" Barb, 100/Bag	B	1	1	\$175.63
904-202001	1/2" Barb, 1/Bag	Bl	5	60	\$2.14
904-202501	5/8" Barb, 1/Bag	Bl	5	60	\$2.16
904-203001	3/4" Barb, 1/Bag	Bl	5	60	\$2.67
904-204001	1" Barb, 1/Bag	Bl	5	60	\$3.57



904-200201

Supply

Drainage

Support

Specialties

Appendix

**Nylon Hose Barb Tees (Cont)**



904-2120203001

Item Number	Item Description	Pkg Type	Min Qty	Case Qty	Price
<b>REDUCING TEE</b>					
904-22161001	3/8" × 3/8" × 1/4" Barb, 1/Bag	BI	5	60	\$2.38
904-22201601	1/2" × 1/2" × 3/8" Barb, 1/Bag	BI	5	60	\$2.38
<b>BULLHEAD TEE</b>					
904-2120203001	1/2" × 1/2" × 3/4" Barb, 1/Bag	BI	5	60	\$2.70
904-22162001	3/8" × 3/8" × 1/2" Barb, 1/Bag	BI	5	60	\$2.56

**Nylon Hose Barb Straight Adapters**

**MIP**



904-41162001



904-404001

Item Number	Item Description	Pkg Type	Min Qty	Case Qty	Price
<b>3/16" BARB</b>					
904-41050201	3/16" Barb × 1/8" MIP, 1/Bag	BI	5	60	\$1.50
904-41051001	3/16" Barb × 1/4" MIP, 1/Bag	BI	5	60	\$1.46
<b>1/4" BARB</b>					
904-401001	1/4" Barb × 1/4" MIP, 1/Bag	BI	5	60	\$1.35
904-41100101	1/4" Barb × 1/8" MIP, 1/Bag	BI	5	60	\$1.42
904-41101601	1/4" Barb × 3/8" MIP, 1/Bag	BI	5	60	\$1.56
904-41102001	1/4" Barb × 1/2" MIP, 1/Bag	BI	5	60	\$1.61
904-41103001	1/4" Barb × 3/4" MIP, 1/Bag	BI	5	60	\$1.77
<b>5/16" BARB</b>					
904-41151001	5/16" Barb × 1/4" MIP, 1/Bag	BI	5	60	\$1.46
<b>3/8" BARB</b>					
904-401601	3/8" Barb × 3/8" MIP, 1/Bag	BI	5	60	\$1.53
904-41160201	3/8" Barb × 1/8" MIP, 1/Bag	BI	5	60	\$1.46
904-41161001	3/8" Barb × 1/4" MIP, 1/Bag	BI	5	60	\$1.82
904-41162001	3/8" Barb × 1/2" MIP, 1/Bag	BI	5	60	\$1.61
904-41163001	3/8" Barb × 3/4" MIP, 1/Bag	BI	5	60	\$1.76
<b>1/2" BARB</b>					
904-402001	1/2" Barb × 1/2" MIP, 1/Bag	BI	5	60	\$1.50
904-41201001	1/2" Barb × 1/4" MIP, 1/Bag	BI	5	60	\$1.46
904-41201601	1/2" Barb × 3/8" MIP, 1/Bag	BI	5	60	\$1.49
904-41203001	1/2" Barb × 3/4" MIP, 1/Bag	BI	5	60	\$1.95
<b>5/8" BARB</b>					
904-41251601	5/8" Barb × 3/8" MIP, 1/Bag	BI	5	60	\$1.50
904-41252001	5/8" Barb × 1/2" MIP, 1/Bag	BI	5	60	\$1.75
904-41253001	5/8" Barb × 3/4" MIP, 1/Bag	BI	5	60	\$1.88
<b>3/4" BARB</b>					
904-403001	3/4" Barb × 3/4" MIP, 1/Bag	BI	5	60	\$1.83
904-41302001	3/4" Barb × 1/2" MIP, 1/Bag	BI	5	60	\$1.83
904-41304001	3/4" Barb × 1" MIP, 1/Bag	BI	5	60	\$2.19
<b>1" BARB</b>					
904-404001	1" Barb × 1" MIP, 1/Bag	BI	5	60	\$2.38
904-41402001	1" Barb × 1/2" MIP, 1/Bag	BI	5	60	\$2.77
904-41403001	1" Barb × 3/4" MIP, 1/Bag	BI	5	60	\$2.20
<b>1-1/4" BARB</b>					
904-405001	1-1/4" Barb × 1-1/4" MIP, 1/Bag	BI	4	4	\$5.11
904-41504001	1-1/4" Barb × 1" MIP, 1/Bag	BI	2	16	\$3.28

Supply

Drainage

Support

Specialties

Appendix

## Nylon Hose Barb Straight Adapters (Cont)

### MIP

Item Number	Item Description	Pkg Type	Min Qty	Case Qty	Price
<b>2" BARB</b>					
904-407001	2" Barb × 2" MIP, 1/Bag	BI	1	4	\$8.20

## Nylon Hose Barb Straight Adapters

### FIP

Item Number	Item Description	Pkg Type	Min Qty	Case Qty	Price
904-457001	2" Barb × 2" FIP, 1/Bag	BI	1	4	\$9.04



904-457001

## Nylon Hose Barb Elbow Adapters

### MIP

Item Number	Item Description	Pkg Type	Min Qty	Case Qty	Price
<b>1/4" BARB</b>					
904-271001	1/4" Barb × 1/4" MIP, 1/Bag	BI	5	60	\$1.81
904-28101601	1/4" Barb × 3/8" MIP, 1/Bag	BI	5	60	\$2.21
904-28102001	1/4" Barb × 1/8" MIP, 1/Bag	BI	5	60	\$1.63
<b>3/8" BARB</b>					
904-271601	3/8" Barb × 3/8" MIP, 1/Bag	BI	5	60	\$1.77
904-28161001	3/8" Barb × 1/4" MIP, 1/Bag	BI	5	60	\$1.98
904-28162001	3/8" Barb × 1/2" MIP, 1/Bag	BI	5	60	\$2.12
904-28163001	3/8" Barb × 3/4" MIP, 1/Bag	BI	5	60	\$2.65
<b>1/2" BARB</b>					
904-272001	1/2" Barb × 1/2" MIP, 1/Bag	BI	5	60	\$2.03
904-28201001	1/2" Barb × 1/4" MIP, 1/Bag	BI	5	60	\$2.07
904-28201601	1/2" Barb × 3/8" MIP, 1/Bag	BI	5	60	\$2.04
904-28203001	1/2" Barb × 3/4" MIP, 1/Bag	BI	5	60	\$2.48
<b>5/8" BARB</b>					
904-28252001	5/8" Barb × 1/2" MIP, 1/Bag	BI	5	60	\$2.46
904-28253001	5/8" Barb × 3/4" MIP, 1/Bag	BI	5	60	\$2.70
<b>3/4" BARB</b>					
904-273001	3/4" Barb × 3/4" MIP, 1/Bag	BI	5	60	\$2.47
904-28302001	3/4" Barb × 1/2" MIP, 1/Bag	BI	5	60	\$2.52
904-28304001	3/4" Barb × 1" MIP, 1/Bag	BI	5	60	\$2.65
<b>1" BARB</b>					
904-284001	1" Barb × 1" MIP, 1/Bag	BI	5	60	\$3.60
904-28403001	1" Barb × 3/4" MIP, 1/Bag	BI	5	60	\$3.17
904-28405001	1" Barb × 1-1/4" MIP, 1/Bag	BI	5	60	\$4.76
<b>1-1/4" BARB</b>					
904-275001	1-1/4" Barb × 1-1/4" MIP, 1/Bag	BI	2	24	\$5.64
<b>1-1/2" BARB</b>					
904-276001	1-1/2" Barb × 1-1/2" MIP, 1/Bag	BI	2	24	\$6.64



904-28102001



# **Brass Garden Hose Fittings**

**Couplings**

**Elbows**

**Straight Adapters**

**Elbow Adapters**

**Cap, Wye**

**Blowout Fittings**

**Washers**





**937-7130101**  
Page 737



**937-803030201**  
Page 737



**937-6730101**  
Page 737



**937-6930101**  
Page 737



**937-65303001**  
Page 738



**937-793002201**  
Page 738

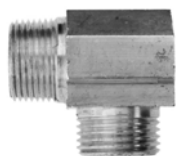

**937-273030101**  
Page 738



**937-4930101**  
Page 738



**937-2330101**  
Page 739



**937-96301001**  
Page 739



**291-30500**  
Page 739

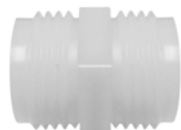

**938-713030101**  
Page 743



**938-673030101**  
Page 743



**938-693030101**  
Page 743



**938-65303000**  
Page



**938-4930101**  
Page 744



Brass Garden Hose Couplings

Item Number	Item Description	Pkg Type	Min Qty	Case Qty	Price
937-1230201	3/4" FHT Swivel Coupling, 1/Bag	BI	5	60	\$7.08
937-123030101	3/4" FHT, 1/Bag	BI	5	60	\$4.54
937-7130101	3/4" MHT, 1/Bag	BI	5	60	\$5.75



937-7130101

Brass Garden Hose Elbow

Item Number	Item Description	Pkg Type	Min Qty	Case Qty	Price
937-803030201	3/4" FHT Swivel x 3/4" MHT, 1/Bag	BI	5	20	\$13.66



937-803030201

Brass Garden Hose Straight Adapters

MIP

Item Number	Item Description	Pkg Type	Min Qty	Case Qty	Price
<b>MHT x MIP</b>					
937-6730101	3/4" MHT x 3/4" MIP, 1/Bag	BI	5	60	\$5.20
937-67303020101	3/4" MHT x 3/4" MIP (1/2" FIP ID), 1/Bag	BI	5	60	\$7.71
937-683020101	3/4" MHT x 1/2" MIP, 1/Bag	BI	5	60	\$4.20
<b>FHT x MIP WITH RUBBER WASHER</b>					
937-7230101	3/4" FHT x 3/4" MIP w/ 1/2" FIP Tap, 1/Bag	BI	5	60	\$6.85
937-723030101	3/4" FHT x 3/4" MIP, 1/Bag	BI	5	60	\$10.39
937-733020101	3/4" FHT x 1/2" MIP, 1/Bag	BI	5	60	\$6.08



937-7230101

Brass Garden Hose Straight Adapters

FIP

Item Number	Item Description	Pkg Type	Min Qty	Case Qty	Price
<b>MHT x FIP</b>					
937-6930101	3/4" MHT x 3/4" FIP, 1/Bag	BI	5	60	\$4.08
937-703020101	3/4" MHT x 1/2" FIP, 1/Bag	BI	5	60	\$3.58
<b>FHT x FIP WITH RUBBER WASHER</b>					
937-7530101	3/4" FHT x 3/4" FIP, 1/Bag	BI	5	40	\$5.20
937-753030201	3/4" FHT x 3/4" FIP Swivel, 1/Bag	BI	5	60	\$7.09
937-763002101	3/4" FHT x 1/8" FIP, 1/Bag	BI	5	20	\$10.11
937-763020101	3/4" FHT x 1/2" FIP, 1/Bag	BI	5	60	\$4.77
937-763020201	3/4" FHT x 1/2" FIP Swivel, 1/Bag	BI	5	60	\$6.29



937-6930101



937-753030201

Supply



937-65303001

Drainage



937-773030101

Support

### Brass Garden Hose Straight Adapters

#### Hose Barb

Item Number	Item Description	Pkg Type	Min Qty	Case Qty	Price
<b>MHT × HOSE BARB</b>					
937-65303001	3/4" MHT × 3/4" Barb, 1/Bag	BI	5	60	\$6.48
937-66302001	3/4" MHT × 1/2" Barb, 1/Bag	BI	5	40	\$5.79
937-66302501	3/4" MHT × 5/8" Barb, 1/Bag	BI	5	20	\$5.28
<b>MACHINED FHT × HOSE BARB</b>					
937-773030101	3/4" FHT × 3/4" ID Barb, Swivel, 1/Bag	BI	5	40	\$4.75
937-782030101	3/4" FHT × 1/2" ID Barb, Swivel, 1/Bag	BI	5	40	\$8.09
937-782530101	3/4" FHT × 5/8" ID Barb, Swivel, 1/Bag	BI	5	40	\$10.91
937-8520300201	3/4" FHT × 3/8" ID Barb, Swivel, 1/Bag	BI	5	40	\$12.67
<b>STAMPED FHT X HOSE BARB</b>					
937-783016201	3/4" FHT × 3/8" ID Barb, Swivel, 1/Bag	BI	5	60	\$8.87
937-783020201	3/4" FHT × 1/2" ID Barb, Swivel, 1/Bag	BI	5	40	\$9.48

Specialties



937-793002201

### Brass Garden Hose Straight Adapters

#### Compression

Item Number	Item Description	Pkg Type	Min Qty	Case Qty	Price
937-793002201	3/4" FHT × 1/4" OD Comp, Swivel, 1/Bag	BI	5	60	\$8.05

Appendix

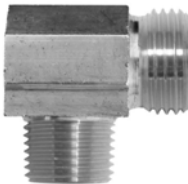

937-273030101

### Brass Garden Hose Elbow Adapters

#### MIP

Item Number	Item Description	Pkg Type	Min Qty	Case Qty	Price
937-273030101	3/4" MHT × 3/4" MIP, 1/Bag	BI	5	20	\$23.59

### Brass Garden Hose Cap



937-4930101

Item Number	Item Description	Pkg Type	Min Qty	Case Qty	Price
937-4930100	3/4" FHT, Stamped, 1/Bag	BI	5	60	\$4.23
937-4930101	3/4" FHT, Machined, 1/Bag	BI	5	60	\$5.66

**Brass Garden Hose Wye**

Item Number	Item Description	Pkg Type	Min Qty	Case Qty	Price
937-2330101	3/4" FHT × 3/4" MHT × 3/4" MHT, 1/Bag	BI	5	20	\$9.61



937-2330101

**Brass Garden Hose Blowout Fittings**

Item Number	Item Description	Pkg Type	Min Qty	Case Qty	Price
937-95301001	3/4" MHT × 1/4" Air I/M, 1/Bag	BI	5	60	\$14.48
937-96301001	3/4" FHT × 1/4" Air I/M w/ Rubber Washer, 1/Bag	BI	5	60	\$15.03



937-96301001

**Brass Garden Hose Washer**

Item Number	Item Description	Pkg Type	Min Qty	Case Qty	Price
291-30500	3/4" Garden Hose Washer	B	12	240	\$0.35



291-30500

Supply

Drainage

Support

Specialties

Appendix



# Nylon Garden Hose Fittings

**Couplings**

**Straight Adapters**

**Cap**





**Nylon Garden Hose Couplings**

Item Number	Item Description	Pkg Type	Min Qty	Case Qty	Price
938-1230101	3/4" FHT, 1/Bag	Bl	5	60	\$9.04
938-713030101	3/4" MHT, 1/Bag	Bl	5	60	\$3.05



938-713030101

**Nylon Garden Hose Straight Adapters**

**MIP**

Item Number	Item Description	Pkg Type	Min Qty	Case Qty	Price
<b>MHT × MIP</b>					
938-673030101	3/4" MHT × 3/4" MIP, 1/Bag	Bl	5	60	\$4.70
938-683020101	3/4" MHT × 1/2" MIP, 1/Bag	Bl	5	60	\$2.75
<b>FHT × MIP</b>					
938-7230101	3/4" FHT × 3/4" MIP, 1/Bag	Bl	5	60	\$4.37



938-673030101



938-7230101

**Nylon Garden Hose Straight Adapters**

**FIP**

Item Number	Item Description	Pkg Type	Min Qty	Case Qty	Price
<b>MHT × FIP</b>					
938-693030101	3/4" MHT × 3/4" FIP, 1/Bag	Bl	5	60	\$10.29
<b>FHT × FIP</b>					
938-7530101	3/4" FHT × 3/4" FIP, 1/Bag	Bl	5	60	\$5.04



938-693030101



938-7530101

## Nylon Garden Hose Straight Adapters

### Hose Barb

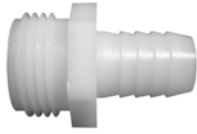

938-65303000



938-773030201



938-4930101

Item Number	Item Description	Pkg Type	Min Qty	Case Qty	Price
<b>MHT × HOSE BARB</b>					
938-65303001	3/4" MHT × 3/4" Barb, 1/Bag	BI	5	40	\$3.69
938-66301001	3/4" MHT × 1/4" Barb, 1/Bag	BI	5	60	\$2.36
938-66301601	3/4" MHT × 3/8" Barb, 1/Bag	BI	5	60	\$2.36
938-66302001	3/4" MHT × 1/2" Barb, 1/Bag	BI	5	40	\$4.02
938-66302501	3/4" MHT × 5/8" Barb, 1/Bag	BI	5	40	\$3.69
<b>FHT × HOSE BARB</b>					
938-773030201	3/4" FHT × 3/4" Barb, 1/Bag	BI	5	60	\$4.37
938-783010201	3/4" FHT × 1/4" Barb, 1/Bag	BI	5	60	\$4.37
938-783016201	3/4" FHT × 3/8" Barb, 1/Bag	BI	5	60	\$4.37
938-783020201	3/4" FHT × 1/2" Barb, 1/Bag	BI	5	60	\$4.02
938-783025201	3/4" FHT Swivel × 5/8" Barb, 1/Bag	BI	5	60	\$4.37

## Nylon Garden Hose Cap

Item Number	Item Description	Pkg Type	Min Qty	Case Qty	Price
938-4930101	3/4" FHT, 1/Bag	BI	5	60	\$1.82

Supply

Drainage

Support

Specialties

Appendix



# Hose Clamps

**Stainless Steel Hose Clamps**

**Easy Clamps**





**Stainless Steel Hose Clamps**

Item Number	Item Description	Pkg Type	Min Qty	Case Qty	Price
<b>5/16" WIDE</b>					
905-050402	Trade Size 4, 1/4" OD To 5/8" OD, 2/Bag	B	5	60	\$2.14
905-050602	Trade Size 6, 5/16" OD To 7/8" OD, 2/Bag	B	5	60	\$2.30
905-050802	Trade Size 8, 7/16" OD To 1" OD, 2/Bag	B	5	60	\$2.98
905-051202	Trade Size 12, 1/2" OD To 1-1/4" OD, 2/Bag	B	5	60	\$3.17
905-052402	Trade Size 24, 1" OD To 2" OD, 2/Bag	B	5	60	\$2.83
905-053602	Trade Size 36, 1-3/4" OD To 2-3/4" OD, 2/Bag	B	5	60	\$2.67
905-055602	Trade Size 56, 3" OD To 4" OD, 1/Bag	B	10	60	\$1.93
905-057202	Trade Size 72, 3" OD To 5" OD, 1/Bag	B	10	60	\$2.28
905-058802	Trade Size 88, 4" OD To 6" OD, 1/Bag	B	10	60	\$4.61
<b>1/2" WIDE</b>					
905-160602	Trade Size 6, 5/16" OD To 7/8" OD, 2/Bag	B	10	120	\$4.33
905-160802	Trade Size 8, 7/16" OD To 1" OD, 2/Bag	B	10	120	\$2.68
901-10	Trade Size 10, 1/2" OD To 1-1/16	B	10	100	\$1.75
901-12	Trade Size 12, 1/2" To 1-1/4", 10/Bag	B	10	100	\$1.94
901-16	Trade Size 16, 11/16" OD To 1-1/2" OD, 10/Bag	B	10	100	\$1.97
901-20	Trade Size 20, 3/4" OD To 1-3/4" OD, 10/Bag	B	10	100	\$1.98
901-24	Trade Size 24, 1" OD To 2" OD, 10/Bag	B	10	100	\$2.17
901-28	Trade Size 28, 1-1/4" OD To 2-1/4" OD, 10/Bag	B	10	100	\$2.23
901-32	Trade Size 32, 1-1/2" OD To 2-1/2" OD, 10/Bag	B	10	100	\$2.27
905-163602	Trade Size 36, 1-3/4" OD To 2-3/4" OD, 2/Bag	B	1	10	\$2.15
905-164002	Trade Size 40, 2" OD To 3" OD, 2/Bag	B	1	10	\$2.15



905-050402



901-20

**EasyClamps**

Item Number	Item Description	Pkg Type	Min Qty	Case Qty	Price
906-0402	1/4" OD, 2/Bag	Bl	5	60	\$2.14
906-0502	5/16" OD, 2/Bag	Bl	5	60	\$5.33
906-0602	3/8" OD, 2/Bag	Bl	5	60	\$1.58
906-0802	1/2" OD, 2/Bag	Bl	5	60	\$1.51
906-1002	5/8" OD, 2/Bag	Bl	5	40	\$1.62
906-1202	3/4" OD, 2/Bag	Bl	10	120	\$3.36
906-1402	7/8" OD, 2/Bag	Bl	10	120	\$2.32



906-0402



# Valves & Cocks

**Straight, Angle**

**Saddle Valves**

**Cooler Fittings**

**Drain Cocks**

**Shutoff Cocks**

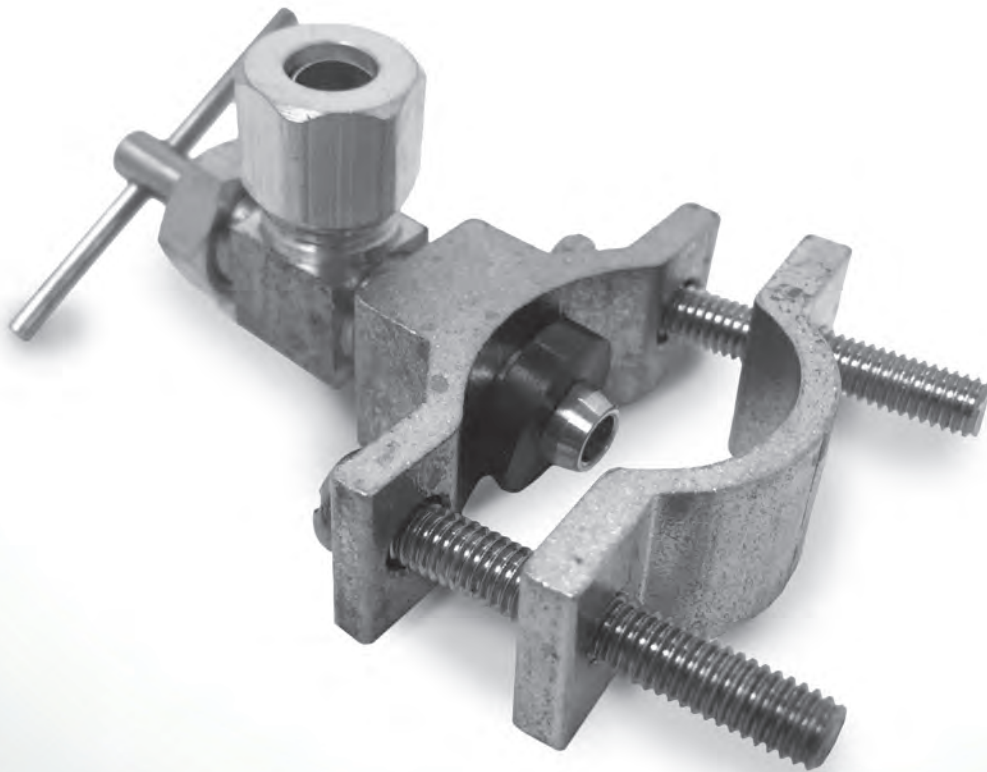



**997-400201**  
**Page 751**



**997-020201104001**  
**Page 751**



**997-940201**  
**Page 752**



**999-56200201**  
**Page 752**



**999-211610V01**  
**Page 752**



**998-05024001**  
**Page 752**



**998-301001**  
**Page 753**

**Needle Valves - Straight**

Item Number	Item Description	Pkg Type	Min Qty	Case Qty	Price
<b>ANDER-LIGN</b>					
997-400201	1/4" OD Ander-Lign, 1/Bag	BI	5	60	\$13.15
997-401001	3/8" OD Ander-Lign, 1/Bag	BI	5	60	\$19.88
<b>ANDER-LIGN × MIP</b>					
997-010201104001	1/4" OD Ander-Lign Less Inerts × 1/4" MIP, 1/Bag	BI	5	60	\$14.82
997-42020201	1/4" OD Ander-Lign × 1/8" MIP, 1/Bag	BI	5	40	\$10.78
<b>COMPRESSION</b>					
997-010206020601	1/4" OD Comp, 1/Bag	BI	5	60	\$6.92
997-011006100601	3/8" OD Comp, 1/Bag	BI	5	60	\$10.41
<b>COMPRESSION × MIP</b>					
997-010206024001	1/4" OD Comp × 1/8" MIP, 1/Bag	BI	5	60	\$6.72
<b>FIP</b>					
997-0102440244	1/8" FIP, 1/Bag	BI	5	60	\$23.25



997-400201

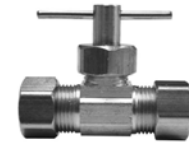

997-010206020601



997-010206024001



997-0102440244

**Needle Valves - Angled**

Item Number	Item Description	Pkg Type	Min Qty	Case Qty	Price
<b>ANDER-LIGN × MIP</b>					
997-0202011040	1/4" OD Ander-Lign Less Inserts × 1/4" MIP, 1/Bag	BI	5	60	\$11.78
997-0242020201	1/4" OD Ander-Lign × 1/8" MIP, 1/Bag	BI	5	60	\$6.22
<b>COMPRESSION × MIP</b>					
997-020201104001	1/4" OD Comp × 1/4" MIP, 1/Bag	BI	5	60	\$11.45
997-020206024001	1/4" OD Comp × 1/8" MIP, 1/Bag	BI	5	60	\$8.72



997-0202011040



997-020201104001

Supply

Drainage

Support

Specialties

Appendix



997-940201

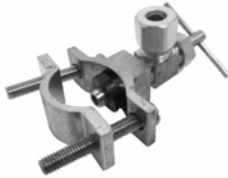

997-022590020601



999-56200201



999-211610V01

### Needle Valves - Saddle Valves

**Related Products**

Add-A-Line™ Push-Fit Tee p 139

Item Number	Item Description	Pkg Type	Min Qty	Case Qty	Price
<b>SELF-TAPPING</b>					
997-940201	Self-Tapping 1/4" OD Ander-Lign, Rough Brass, 1/Bag	BI	5	60	\$9.25
997-941001	Self-Tapping 3/8" OD Ander-Lign, Rough Brass, 1/Bag	BI	5	40	\$9.25
<b>DRILL-TYPE</b>					
997-022590020601	Drill Type × 1/4" OD Comp., Rough Brass 1/Bag	BI	5	60	\$14.45

### Cooler Fittings

**FIP × MIP Adapter**

Item Number	Item Description	Pkg Type	Min Qty	Case Qty	Price
999-56200201	1/2" FIP × 1/2" MIP Cooler Adapter w/ 1/8" Tap, 1/Bag	BI	5	60	\$10.78
999-56300201	3/4" FIP × 3/4" MIP Cooler Adapter w/ 1/8" Tap, 1/Bag	BI	5	60	\$47.14

### Cooler Fittings

**Cooler Valve**

Item Number	Item Description	Pkg Type	Min Qty	Case Qty	Price
999-211610V01	3/8" OD × 3/8" OD w/ 1/4" OD Needle Ander-lign, Rough Brass 1/Bag	BI	5	60	\$23.92

### Drain Cocks

Item Number	Item Description	Pkg Type	Min Qty	Case Qty	Price
998-05024001	1/8" MIP w/ Tee Handle, 1/Bag	BI	5	60	\$17.10
998-05104001	1/4" MIP w/ Tee Handle, 1/Bag	BI	5	60	\$15.46



**Shutoff Cocks**

Item Number	Item Description	Pkg Type	Min Qty	Case Qty	Price
<b>COMPRESSION</b>					
998-301001	3/8" OD Comp, 1/Bag	Bl	5	20	\$17.97
<b>MIP x FIP</b>					
998-011044104001	1/4" FIP x 1/4" MIP, 1/Bag	Bl	5	60	\$29.29
<b>FLARE x FIP</b>					
998-51102001	3/8" OD Flare x 1/2" FIP, 1/Bag	Bl	5	20	\$47.78
998-51162001	1/2" OD Flare x 1/2" FIP, 1/Bag	Bl	5	20	\$35.47
<b>FLARE x FLARE</b>					
998-011048104801	3/8 OD Flare	Bl	5	40	\$21.73



998-301001



998-011044104001



998-51102001

Supply

Drainage

Support

Specialties

Appendix



# Pool Hose Fittings

**Couplings**

**Cuffs**





**Pool Hose Couplings**

Item Number	Item Description	Pkg Type	Min Qty	Case Qty	Price
902-125001	1-1/4", 1/Bag	Bl	2	24	\$7.69
902-126001	1-1/2", 1/Bag	Bl	2	24	\$7.72

**Pool Hose Cuffs**

**Related Products**

Pool & Spa Vacuum Hose p 0

Item Number	Item Description	Pkg Type	Min Qty	Case Qty	Price
902-135002	1-1/4", 1/Bag	Bl	2	24	\$5.76



902-126001

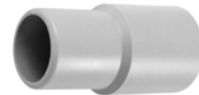

902-135002

Supply

Drainage

Support

Specialties

Appendix



# **Tools & Chemicals**

**PowerPEX<sup>®</sup> Tools**

**Tools & Accessories**

**Brushes & Abrasives**

**Sealants, Lubricants  
& Tapes**

**Chemicals**

# Tools & Chemicals

## PowerPEX<sup>®</sup> Tools

Crimp tools for PEX F1807 and F2159 joints using a copper crimp ring, and compression tools for joints using the stainless steel V-Sleeve<sup>™</sup>. Expansion tools and heads for F1960 joints with PEX expansion sleeves.

## Tools & Accessories

A variety of cutting tools, wrenches, and other tools for all types of plumbing installations.

## Brushes & Abrasives

Brushes for applying pipe dope and cement, and abrasive pads/tools for cleaning copper.

## Sealants, Lubricants & Tapes

Adhesive and thread-sealing tapes, hydraulic cement and silicone thread/stem lubricant.

## Chemicals

FlowEasy<sup>™</sup> fast-acting, drain cleaner uses buffered sulphuric acid to dissolve clogs without damage to plumbing systems



# **PowerPEX<sup>®</sup>** **Tools**

**ASTM F1807/F2159 Tools**

**ASTM F1960 Tools**





## ASTM F1807/F2159 Tools

### Crimp Tools

- Steel handles
- Compact tools allow one-hand crimping
- Combo tools for the most common crimp connections and added cost savings
- Free Go/No-Go gauge provided with every model
- Also works on PB 1380 tube and fittings

Item Number	Item Description	Pkg Type	Min Qty	Case Qty	Price
<b>STANDARD</b>					
305-7023	1/2"- 3/4", Straight Handle	Bl	1	10	\$167.94
305-7040	1", Straight Handle	Bl	1	10	\$177.82
305-7050	1-1/4", Straight Handle	Bl	1	10	\$187.14
305-7095	5-N-1 Combo Kit w/ Case (3/8"- 1/2"- 5/8"- 3/4"- 1") Straight Handle	Bl	1	5	\$249.97
<b>COMPACT</b>					
305-7110	3/8" w/ Case	Bl	1	8	\$128.43
305-7120	1/2" w/ Case	Bl	1	8	\$128.43
305-7123	1/2"- 3/4" w/ Case	Bl	1	8	\$163.85
305-7130	3/4" w/ Case	Bl	1	8	\$128.43
<b>GO/NO-GO CRIMP GAUGE</b>					
305-995	3/8", 1/2", 5/8", 3/4", 1", 1/Bag	Bl	1	200	\$8.73

## ASTM F1807/F2159 Tools

### Crimp Ring Removal Tools

- Use only on Brass or Stainless Steel fittings
- Two cuts on copper ring allows user to reclaim fitting
- Cutting blade only penetrates the copper ring and pipe
- Suitable for use on 1/2" through 1" PEX pipe sizes
- Allows fitting recovery without damaging the sealing surfaces of the fitting

Item Number	Item Description	Pkg Type	Min Qty	Case Qty	Price
305-999	3/8" - 1"	Bl	1	40	\$72.70



305-7095



305-7120



305-999

Supply

Drainage

Support

Specialties

Appendix

Supply

Drainage

Support

Specialties

Appendix



305-82TX



305-92TX



305-85TX



305-W2H



305-X665

## ASTM F1807/F2159 Tools

### V-Sleeve™ Compression Tools

· Exclusively for installing Sioux Chief's V-Sleeve™ stainless steel PEX compression system

Item Number	Item Description	Pkg Type	Min Qty	Case Qty	Price
<b>STANDARD COMPRESSION TOOL</b>					
305-802	1/2" Straight Handle	BI	1	20	\$192.00
305-803	3/4" Straight Handle	BI	1	20	\$192.00
305-804	1" Straight Handle	BI	1	10	\$212.00
305-82TX	1/2" Straight Handle	BI	1	10	\$167.95
305-84TX	1" Straight Handle	BI	1	10	\$177.82
<b>COMPACT COMPRESSION TOOL</b>					
305-92TX	1/2"	BI	1	10	\$154.12
<b>GO/NO-GO COMPRESSION GAUGE</b>					
305-85TX	1/2", 3/4", & 1"	BI	1	12	\$11.47

## ASTM F1960 Tools

### Expansion Tools

- To insure a proper joint, Sioux Chief suggests the use of a power rotating tool
- For use with PowerPEX™ A Tube and Fittings
- Compatible with all F1960 PEX Expansion Systems

Item Number	Item Description	Pkg Type	Min Qty	Case Qty	Price
305-W23KIT	F1960 Standard Tool Kit w/ 1/2" & 3/4" Heads	BI	1	5	\$457.49
305-WT	F1960 Pipe Expander Tool Only	BI	1	10	\$254.32
<b>EXPANDER HEADS</b>					
305-W2H	1/2"	BI	1	20	\$97.84
305-W3H	3/4"	BI	1	20	\$97.84
305-W4H	1"	BI	1	20	\$97.84

## PowerPex® Coil Unwinder

Item Number	Item Description	Pkg Type	Min Qty	Case Qty	Price
305-X665	PEX Tube Coil Unwinder	BI	1	1	\$467.53

# **Tools & Accessories**

**Tube Cutters, SawHorse™, Inside Pipe Cutter**

**Metal Stud Punch, Slip-Joint Pliers, Box Wrench**

**Basin Wrench, Allen Wrench Set, Strap Wrench**

**PO Plug Wrench, Faucet Seat Wrench**

**Tub/Shower Socket Set, Element Wrench**

**Screwdrivers, Push-fit Disconnect Tools**

**Faucet Handle Puller, Flaring Tool**

**Inspection Mirror, Levels, Tape Measure**

**Plunger, Work Gloves, Tie-Down Straps**

**Buckets, Boxes**



**304-11**  
Page 767



**315-10**  
Page 767



**300-12**  
Page 768



**390-50153**  
Page 769



**304-06**  
Page 769



**306-10**  
Page 770



**316-2**  
Page 770



**390-50197**  
Page 770



**307-625**  
Page 771



**311-10**  
Page 771



**314-10**  
Page 772



**305Q2**  
Page 772

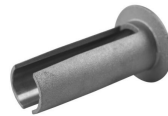

**305-RT**  
Page 772



**318-4**  
Page 773



**390-50138**  
Page 773



**390-50117**  
Page 773



**390-50115**  
Page 774



**310-12**  
Page 774



**310-05**  
Page 774



**312-2**  
Page 774



**961-32**  
Page 775



**319-15**  
Page 775



**968-04**  
Page



**965-204**  
Page 775



**390-50200**  
Page 775

### Poly Tube Cutters

- The 304-08 & 304-12 cutters are to be used for 1-1/8" O.D. tube or smaller
- The 304-11 & 305-A139092 cutters ratchet, making PVC pipe cuts quick and easy

Item Number	Item Description	Pkg Type	Min Qty	Case Qty	Price
<b>STANDARD</b>					
304-08	Plastic Tube And Hose Cutter - 2-1/4" Blade Length	BI	12	72	\$24.37
304-1	Replacement Blade For 304-08	BI	1	50	\$9.07
304-12	Plastic Tube And Hose Cutter - 3-1/4" Blade Length	BI	12	12	\$24.37
304-12B	Replacement Blade For 304-12	BI	1	12	\$10.52
<b>RATCHETING</b>					
304-11	Cuts 3/8" Thru 1-1/4" Diameter Tube/Pipe	BI	12	12	\$29.65
305-A139092	Cuts 1-1/4" Thru 2" Diameter Tube/Pipe	BI	1	10	\$309.26
305-A139092B	Replacement Blade for 305-A139092	BI	1	25	\$35.62



304-08



304-11

### Copper Tube Cutters

- The 304-25 & 304-30 include a replacement cutting wheel
- Lightweight aluminum bodies

Item Number	Item Description	Pkg Type	Min Qty	Case Qty	Price
304-20	Mini Cutter, 1/8" Thru 5/8" Capacity	BI	1	24	\$9.96
304-25	Internal Adjustment Cutter w/ Deburring Tool, 1/8" Thru 1-1/8" Capacity	BI	1	10	\$27.11
304-30	Zip Action Cutter w/ Deburring Tool, 3/16" Thru 1-1/4" Capacity	BI	1	10	\$46.67
304-32	Replacement Wheel For 304-25/304-30	BI	1	20	\$5.24



304-20

### Utility Knife

Item Number	Item Description	Pkg Type	Min Qty	Case Qty	Price
315-1	Replacement Blades, 5 Blades/Card	B	10	100	\$2.88
315-10	Utility Knife w/ One Blade	B	12	60	\$10.92



315-10

Supply

Drainage

Support

Specialties

Appendix

Supply

Drainage

Support

Specialties

Appendix



300-12



300-20



300-12B



301-062



301-065



301-061



390-50105

## SawHorse™ Multi-Purpose Saws

- High-quality, hardened-steel blade remains sharp through thousands of cuts
- Perfect for plastic pipe, wood and many other materials
- 12" model has 13 teeth/inch for fine cutting
- Teeth are on nose of blade for notching in tight areas and starting cuts in the middle of floor or wall
- 20" model has 10 teeth/inch for faster cutting

Item Number	Item Description	Pkg Type	Min Qty	Case Qty	Price
<b>SAWS</b>					
300-12	12" w/ Plastic Teeth Protector	B	12	12	\$21.20
300-20	20" w/ Plastic Teeth Protector	B	4	4	\$44.75
<b>REPLACEMENT BLADES</b>					
300-12B	Replacement Blade For 300-12	B	1	25	\$17.09
300-20B	Replacement Blade For 300-20	B	6	6	\$30.78

## SawHorse™ Mini Hacksaws

- Pistol Grip model has a separate screw to set the 6" blade tension

Item Number	Item Description	Pkg Type	Min Qty	Case Qty	Price
<b>SAWS</b>					
301-062	Deluxe Pistol Grip, 6" Blade	B	10	10	\$17.20
301-065	Standard D-Type, 6" Blade	B	20	20	\$3.59
<b>REPLACEMENT BLADES</b>					
301-061	6" Carbon Steel Replacement Blade 32 Teeth/Inch, Pin Ends	B	5	100	\$1.28

## Wire Cable Saw

- Cuts PVC Pipe in tight places
- Disposable, good for approximately 40 cuts

Item Number	Item Description	Pkg Type	Min Qty	Case Qty	Price
390-50105	36" Wire Cable Saw For Plastic Pipe	BI	1	25	\$4.00



### Inside Pipe Cutter

- Steel blade for plastic pipe
- Abrasive blade for plastic or steel pipe

Item Number	Item Description	Pkg Type	Min Qty	Case Qty	Price
<b>PIPE CUTTER</b>					
390-50153	Inside Pipe Cutter w/ Two 1-9/16" Abrasive Discs	BI	10	100	\$16.53
390-50163	Inside Pipe Cutter w/ 1-1/4" Steel Blade	BI	10	100	\$19.10
<b>REPLACEMENT BLADES</b>					
390-50154	Kit: 3 Abrasive Discs, 1 Bolt, 1 Washer	BI	10	100	\$13.42
390-50164	1 Hardened Steel Blade Only	BI	10	100	\$4.35

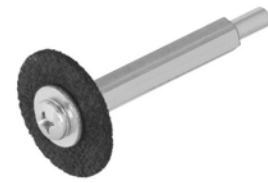

390-50153



390-50163



390-50154

### Deburring Tool

- High carbon steel blade storage in the plastic body

Item Number	Item Description	Pkg Type	Min Qty	Case Qty	Price
304-06	Deburring Tool, Includes One Spare Blade	BI	24	24	\$11.15



304-06

### Metal Stud Punch

- Cuts a 1-11/32" hole in 20 gauge steel
- Maximum cutting depth is 3-1/2" from edge of stud
- Lightweight, high-strength aluminum alloy

Item Number	Item Description	Pkg Type	Min Qty	Case Qty	Price
305-521PK	1-11/32" Hole w/ Carrying Case	BI	1	5	\$304.95
305-521PKB	Cutting Bit Replacement	B	1	10	\$25.54



305-521PK

Supply

Drainage

Support

Specialties

Appendix



306-10

### Slip-Joint Pliers

- Milled jaw, nickel-plated finish with plastic grips

Item Number	Item Description	Pkg Type	Min Qty	Case Qty	Price
306-10	10" Angle-Nose Pliers	BI	10	50	\$28.30



316-2

### Ratcheting Offset Box Wrenches

- 25° offset angle
- Speed and convenience of ratcheting box wrench
- Reverse by flipping lever

Item Number	Item Description	Pkg Type	Min Qty	Case Qty	Price
316-1	3/8" x 7/16" Ratchet Box Wrench	BI	1	12	\$8.84
316-2	1/2" x 9/16" Ratchet Box Wrench	BI	1	12	\$10.89

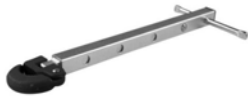

390-50197

### Telescoping Basin Wrench

- Jaw capacity: 3/8" thru 1-1/8"
- Length adjust to 9-1/2", 12", 14" and 16-1/2"

Item Number	Item Description	Pkg Type	Min Qty	Case Qty	Price
390-50197	Telescopic Basin Wrench	BI	1	20	\$29.83



318-9

### Allen Wrench Set

- 5/64", 3/32", 7/64", 1/8", 9/64", 5/32", 3/16", 7/32" & 1/4"

Item Number	Item Description	Pkg Type	Min Qty	Case Qty	Price
318-9	9Pc Fold-Up Allen Wrench Set	BI	1	10	\$8.46



313-20

### Strap Wrench

- Reinforced rubber strap adjusts to fit any shape

Item Number	Item Description	Pkg Type	Min Qty	Case Qty	Price
313-20	Strap Wrench	BI	1	12	\$22.34

**Shower Arm Installation Tool**

· Shower arm installation tool allows for easier install with no external damage

Item Number	Item Description	Pkg Type	Min Qty	Case Qty	Price
307-625	Shower Arm Installation Tool	BI	1	6	\$11.06



307-625

**PO Plug Wrench**

· Holds P.O. plug and basket straight during installation

Item Number	Item Description	Pkg Type	Min Qty	Case Qty	Price
390-50198	Pop-Up & Overflow Plug Wrench	BI	1	20	\$10.82



390-50198

**Faucet Seat Wrenches**

· Ratchet wrench set has two square and one hex wrench plus a ratchet

Item Number	Item Description	Pkg Type	Min Qty	Case Qty	Price
390-50130	Ratchet Wrench Set	BI	1	25	\$43.88
390-50132	Straight Wrench Tool	BI	1	12	\$10.85
390-50133	Angle Wrench Tool	BI	1	12	\$11.93



390-50130

**Faucet Stem Key**

· Fits 1/4", 9/32", 5/16" and 11/32" faucet and sillcock stems

Item Number	Item Description	Pkg Type	Min Qty	Case Qty	Price
390-50134	Four-Way Faucet Stem Key	BI	1	12	\$6.91



390-50134

**Tub/Shower Socket Set**

· Each set includes the following wrenches: 21/32" x 27/32", 29/32" x 31/32", 1-1/32" x 1-3/32", 1-5/32" x 1-9/32", 1-11/32" x 1--7/16" and one 5" turning bar

Item Number	Item Description	Pkg Type	Min Qty	Case Qty	Price
311-10	Set w/ Carrier Handle	BI	1	5	\$22.91



311-10

Supply

Drainage

Support

Specialties

Appendix

Supply

Drainage

Support

Specialties

Appendix



### Water Heater Element Wrench

- 1-1/2" hex 3-3/4" in length and constructed of 1/8" thick, heavy-duty plated steel
- Hole is 11/32" for leverage bar (not included)

Item Number	Item Description	Pkg Type	Min Qty	Case Qty	Price
390-50185	Water Heater Element Wrench	BI	1	10	\$13.70



### Screwdrivers

- Includes one dual ended slotted bit, one dual ended Phillips bot and one 5/16" x 1/4" nut driver shank
- Replacement bits available

Item Number	Item Description	Pkg Type	Min Qty	Case Qty	Price
314-10	Six-In-One Screwdriver, Red Handle - Display Pack	BI	12	12	\$11.59
314-12	Six-In-One w/ Easy Grip Rubber Handle	BI	12	12	\$12.27

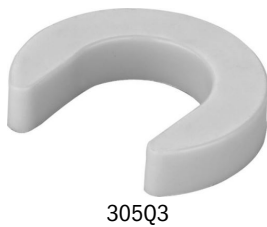

### PDQ™ Push-Fit Disconnect Tools

- Quickly and easily disconnects push fittings

Item Number	Item Description	Pkg Type	Min Qty	Case Qty	Price
305Q2	1/2", 1/Bag	CI	24	24	\$2.41
305Q23PK1	1/2" & 3/4", 1 Pair/Bag	BI	12	12	\$4.80
305Q3	3/4", 1/Bag	CI	24	24	\$2.41
305Q4	1", 1/Bag	CI	12	12	\$2.70
305Q4PK1	1", 1/Bag	BI	5	400	\$2.95
305Q5	1-1/4", 1/Bag	BI	5	5	\$26.60
305Q6	1-1/2", 1/Bag	BI	1	1	\$28.33
305Q7	2", 1/Bag	BI	1	1	\$28.33



### Access Grommet Removal Tool

Item Number	Item Description	Pkg Type	Min Qty	Case Qty	Price
305-RT	Valve Grommet Removal Tool For Access Products	BI	1	10	\$6.54

**Shower WallNut™ Removal Tool**

Item Number	Item Description	Pkg Type	Min Qty	Case Qty	Price
307-616	Shower Wallnut Removal Tool	BI	1	10	\$39.08



307-616

**Moen Cartridge Puller**

- Removes Moen #1200 and #1225 cartridges
- Includes adapter for Posi-temp valves

Item Number	Item Description	Pkg Type	Min Qty	Case Qty	Price
390-50128	Puller For Moen	BI	1	12	\$14.56



390-50128

**Faucet Handle Puller**

- Longer, adjustable puller arms allow for removal of larger handles

Item Number	Item Description	Pkg Type	Min Qty	Case Qty	Price
318-4	Faucet Handle Puller	BI	1	5	\$19.37



318-4

**Flaring Tool**

- Single-lap 45° flares thin wall tubing such as copper, brass or aluminum
- Flares 3/16" OD to 5/8" OD

Item Number	Item Description	Pkg Type	Min Qty	Case Qty	Price
308-2	Deluxe Flaring Tool	BI	1	12	\$69.43



308-2

**O-Ring Pick**

Item Number	Item Description	Pkg Type	Min Qty	Case Qty	Price
390-50138	Deluxe O-Ring Pick	BI	1	12	\$7.93



390-50138

**Flexible Grabber**

Item Number	Item Description	Pkg Type	Min Qty	Case Qty	Price
390-50117	23" Flexible Grabber	BI	1	25	\$5.83



390-50117

Supply

Drainage

Support

Specialties

Appendix

Supply



390-50115

### Inspection Mirror

- 1" x 2" oval mirror with an angle ball joint
- Extends 5-5/8" to 18-3/4"

Item Number	Item Description	Pkg Type	Min Qty	Case Qty	Price
390-50115	Extendable Inspection Mirror w/ Magnetic Tip	BI	1	24	\$13.17

Drainage



390-50110

### Match Holder

- Extends 6" to 25"

Item Number	Item Description	Pkg Type	Min Qty	Case Qty	Price
390-50110	Extendable Match Holder w/ Pocket Clasp	BI	1	25	\$11.90

Support



310-10

### Levels

- The 1-3/4" OD surface level, levels horizontal and vertical at the same time
- Heavy-Duty 1" wide

Item Number	Item Description	Pkg Type	Min Qty	Case Qty	Price
310-10	Surface Level	B	1	24	\$4.08
310-12	10" Aluminum Level, Magnetic	BI	1	10	\$23.07

Specialties



310-05

### Tape Measure

Item Number	Item Description	Pkg Type	Min Qty	Case Qty	Price
310-05	25' Locking Tape Measure	BI	1	12	\$17.52

Appendix



312-2

### Plunger

- The 312-2 has a funnel-shaped cap that is retractable for use in flat sinks

Item Number	Item Description	Pkg Type	Min Qty	Case Qty	Price
312-2	Funnel Type Rubber Plunger – 20" Handle	BI	1	12	\$9.95

### SafeFlame™ Protection Pad

· A heat absorbing 9" x 12" non asbestos blanket

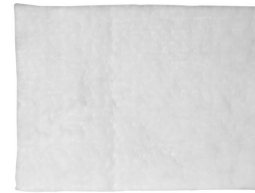

390-50160

Item Number	Item Description	Pkg Type	Min Qty	Case Qty	Price
390-50160	Flame Protection Blanket	BI	1	25	\$23.59

### Work Gloves

Item Number	Item Description	Pkg Type	Min Qty	Case Qty	Price
961-20	Brown Jersey Gloves, 1/Pair	B	24	24	\$3.26
961-22	Knit Gloves w/ Gripping Dots, 1/Pair	B	24	24	\$3.88
961-32	All Leather Gloves, Large, 1/Pair	B	1	12	\$14.05
961-34	All Leather Gloves, Extra Large, 1/Pair	B	1	12	\$14.05



961-32

### Tie-Down Straps

· With 2-1/2" galvanized S-hooks



319-20

Item Number	Item Description	Pkg Type	Min Qty	Case Qty	Price
319-15	15"- 22" EPDM Tie-Down Strap	B	50	50	\$2.98
319-20	20"- 30" EPDM Tie-Down Strap	B	50	50	\$3.21
319-31	31"- 45" EPDM Tie-Down Strap	B	50	50	\$4.19

### Bin Boxes

Item Number	Item Description	Pkg Type	Min Qty	Case Qty	Price
965-204	12" Deep x 4" Wide x 4-1/2" High	B	25	25	\$2.80
965-208	12" Deep x 8" Wide x 4-1/2" High	B	25	25	\$4.06
965-212	12" Deep x 12" Wide x 4-1/2" High	B	25	25	\$4.69
965-804	18" Deep x 4" Wide x 4-1/2" High	B	25	25	\$3.90
965-808	18" Deep x 8" Wide x 4-1/2" High	B	25	25	\$4.69
965-812	18" Deep x 12" Wide x 4-1/2" High	B	25	25	\$5.18



965-204

### Peg-Board Hook

· 8" long x 3/16" wire



390-50200

Item Number	Item Description	Pkg Type	Min Qty	Case Qty	Price
390-50200	Peg Board Hook	B	10	50	\$1.30





# **Brushes & Abrasives**

**Fitting Brushes**

**Acid/Cement Brushes**

**Tube OD Brush**

**Abrasive Cleaning Pads**

**Abrasive Mesh**





**Fitting Brushes**

Item Number	Item Description	Pkg Type	Min Qty	Case Qty	Price
<b>DELUXE WOOD HANDLE</b>					
704-2	1/2" CTS, Stainless Steel	B	12	72	\$2.90
704-3	3/4" CTS, Stainless Steel	B	12	72	\$3.32
704-4	1" CTS, Stainless Steel	B	12	72	\$3.35
<b>PLASTIC HANDLE</b>					
700-0	1/4" CTS, Carbon Steel	B	12	120	\$5.24
700-1	3/8" CTS, Carbon Steel	B	12	120	\$4.03
700-2	1/2" CTS, Carbon Steel	B	12	120	\$4.03
700-3	3/4" CTS, Carbon Steel	B	12	120	\$4.18
700-4	1" CTS, Carbon Steel	B	12	120	\$4.57
700-5	1-1/4" CTS, Carbon Steel	B	6	60	\$4.97
700-6	1-1/2" CTS, Carbon Steel	B	6	60	\$5.42
700-7	2" CTS, Carbon Steel	B	6	60	\$6.31
705-2	1/2" CTS, Stainless Steel	B	12	120	\$9.82
705-3	3/4" CTS, Stainless Steel	B	12	120	\$10.22
705-4	1" CTS, Stainless Steel	B	12	120	\$9.32
<b>OPEN-LOOP HANDLE</b>					
702-2	1/2" CTS, Carbon Steel	B	24	240	\$1.79
702-3	3/4" CTS, Carbon Steel	B	24	240	\$1.86
702-4	1" CTS, Carbon Steel	B	24	240	\$2.12
703-2	1/2" CTS, Stainless Steel	B	24	240	\$1.91
703-3	3/4" CTS, Stainless Steel	B	24	240	\$1.96
703-4	1" CTS, Stainless Steel	B	24	240	\$2.21
703-5	1-1/4" CTS, Stainless Steel	B	12	120	\$3.42
703-6	1-1/2" CTS, Stainless Steel	B	6	60	\$3.73
703-7	2" CTS, Stainless Steel	B	6	60	\$4.20
<b>DRILL ATTACHMENT</b>					
706-2	1/2" CTS, Carbon Steel	B	12	72	\$2.04
706-3	3/4" CTS, Carbon Steel	B	12	72	\$2.11
706-4	1" CTS, Carbon Steel	B	12	72	\$2.41
707-2	1/2" CTS, Stainless Steel	B	12	72	\$2.22
707-3	3/4" CTS, Stainless Steel	B	12	72	\$2.30
707-4	1" CTS, Stainless Steel	B	12	72	\$2.54

**Acid/Cement Brushes**

Item Number	Item Description	Pkg Type	Min Qty	Case Qty	Price
<b>ACID BRUSHES</b>					
771	3/8" Wide, 6" Long, 100% Horse Hair, 144/Bag	B	1	12	\$35.73
772	1/2" Wide, 6" Long, 100% Horse Hair, 144/Bag	B	1	12	\$45.15
<b>DOPE/CEMENT BRUSHES</b>					
773	3/4" Wide, Horse Hair	B	36	360	\$2.18
774	1" Wide, Natural	B	36	36	\$3.41
776	1 1/2" Wide, Natural	B	24	24	\$4.99
777	2" Wide, Natural	B	24	24	\$5.59



704-2



700-2



703-2



706-3

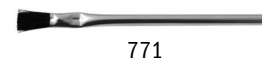

771



774

Supply

Drainage

Support

Specialties

Appendix

Supply

Drainage

Support

Specialties

Appendix

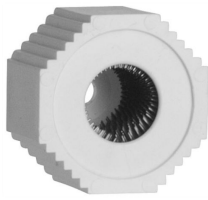

710-2

### Tube OD Brush

Item Number	Item Description	Pkg Type	Min Qty	Case Qty	Price
710-2	1/2" CTS	B	6	120	\$7.56
710-3	3/4" CTS	B	6	120	\$8.50
710-4	1" CTS	B	6	120	\$9.61



750-46

### Abrasive Cleaning Pads

- Cleans copper tube and fittings for soldering when used wet or dry

Item Number	Item Description	Pkg Type	Min Qty	Case Qty	Price
750-46	4" x 6" Fine Grit, Red Nylon Pad, 10 /Bag	B	1	14	\$11.75
750-69	6" x 9" Fine Grit, Tight Weave, Red Nylon Pad, 5/Bag	B	1	12	\$10.01
752-69	6" x 9" Medium Grit, Loose Weave, Green Nylon Pad, 5/Bag	B	1	12	\$7.57



730-05

### Abrasive Mesh/Cloth

- Abrasive Mesh - 180 grit open mesh is waterproof, rinse when mesh gets loaded with debris
- Sand Cloth - 120 grit brown cloth is water resistant
- Wet-Proof Cloth - 120 grit blue cloth is 100% waterproof.

Item Number	Item Description	Pkg Type	Min Qty	Case Qty	Price
<b>ABRASIVE MESH</b>					
730-05	5 Yard Roll In Dispenser Box	BI	1	24	\$10.25
730-10	10 Yard Roll In Dispenser Box	BI	1	24	\$17.14
730-25	25 Yard Roll In Dispenser Box	BI	1	12	\$38.21
<b>SAND CLOTH</b>					
740-02	2 Yard Roll In Bag	BI	1	50	\$3.33
740-05	5 Yard Roll In Dispenser Box	BI	1	24	\$5.88
740-10	10 Yard Roll In Dispenser Box	BI	1	24	\$10.97
740-25	25 Yard Roll In Dispenser Box	BI	1	12	\$24.44
<b>WET-PROOF CLOTH</b>					
743-05	5 Yard Roll In Dispenser Box	BI	1	24	\$8.53
743-10	10 Yard Roll In Dispenser Box	BI	1	24	\$13.35
743-25	25 Yard Roll In Dispenser Box	BI	1	12	\$29.59



740-10



743-05

# Sealants, Lubricants & Tapes

Sealants

Lubricants

Tapes





**Sealants**

**Cement Stop Leak**

- Perfect for patching sewer outlet, water service or around drains
- Sets up in just five minutes



963-05

Item Number	Item Description	Pkg Type	Min Qty	Case Qty	Price
963-05	Cement Stop Leak, 5 Lb. Plastic Jar	BI	5	5	\$28.73

**Sealants**

**Oakum**

- Use to pack spigot type cast iron pipe and fittings



963-15PK2

Item Number	Item Description	Pkg Type	Min Qty	Case Qty	Price
963-15PK2	Brown Oakum, 1 Lb/Bag	BI	20	20	\$19.08

**Lubricants**

**Silicone Lubricant**

- FDA approved
- Does not deteriorate o-rings and other EPDM, buna or rubber seats and seals.



963-01

Item Number	Item Description	Pkg Type	Min Qty	Case Qty	Price
963-01	Silicone Lubricant - 1/4 Oz. Tub	B	24	240	\$4.26

**Tapes**

**Duct Tape**

- HVAC grade has more adhesive
- HVAC grade is tested in accordance with UL 723 Flame Spread Index 5, Smoke Development Index 5



330-260

Item Number	Item Description	Pkg Type	Min Qty	Case Qty	Price
330-260	2" Wide x 60 Yard Roll, Industrial Grade 9 Mil	BI	24	24	\$14.99
332-260	2" Wide x 60 Yard Roll, HVAC Grade 11.5 Mil	BI	24	24	\$24.64

Supply

Drainage

Support

Specialties

Appendix



335-260

## Tapes

### Pipe Thread Tape

- PTFE (Polytetrafluoroethylene)

Item Number	Item Description	Pkg Type	Min Qty	Case Qty	Price
335-260	1/2" × 260" Spool	BI	100	500	\$0.62
335-263	3/4" × 260" Spool	BI	70	350	\$0.94
335-520	1/2" × 520" Spool	BI	100	500	\$0.95
335-523	3/4" × 520" Spool	BI	70	350	\$1.56



# Chemicals

## FlowEasy™ Drain Cleaner





## FlowEasy™ - Liquid Drain Cleaner

- A virgin sulfuric acid with twelve buffers and inhibitors
- Heats up slowly to temper toilets and can be poured into standing water
- The only instant drain opener that is safe for the consumer but strong enough for the professional



963-HTL-FE128

Item Number	Item Description	Pkg Type	Min Qty	Case Qty	Price
963-HTL-FE128	One-Gallon Bottle FlowEasy™	BI	4	4	\$65.00
963-HTL-FE20	20 oz Bottle FlowEasy™	BI	12	12	\$16.07
963-HTL-FE32	32 Oz Bottle FlowEasy™	BI	12	12	\$23.31
963-HTL-FE64	Half-Gallon Bottle FlowEasy™	BI	4	4	\$41.28

Supply

Drainage

Support

Specialties

Appendix



# **Appendix**

**Alphabetical Index**

**Numerical Index**

**Rep Information**

**General Reference**

**Warranty & Terms**



**1**

- 1/2" ComPEX Branch, Manifold 43
- 1/2" F1807 Branch, Manifold 35-42
  - 1" CPVC x Spun Closed Trunk 42
  - 1" F1807 x 1" F1807 Trunk 38
  - 1" F1807 x Spun Closed Trunk 37
  - 1" FSWT x Spun Closed Trunk 41
  - 1" MSWT x 1" FSWT Trunk 41-42
  - 1" MSWT x 1" MSWT Trunk 40
  - 1" MSWT x Spun Closed Trunk 40
- 1/2" F1807 x 3/4" F1807 Trunk 37
- 1/2" F1807 x Closed Trunk 36
- 3/4" F1807 x 1" F1807 Trunk 37
- 3/4" F1807 x 3/4" F1807 Trunk 36
- 3/4" F1807 x Spun Closed Trunk 35
- 3/4" MSWT x 3/4" FSWT Trunk 39
- 3/4" MSWT x 3/4" MSWT, Extended Trunk 39
- 3/4" MSWT x Spun Closed Trunk 38
- 1/2" F1807 Branch, Multi-Port Tee 43-44
  - 3/4" F1807 x 3/4" F1807 Trunk 44
  - 3/4" F1807 x Closed Trunk 43
- 1/2" F1960 Branch, Multi-Port Tee 72-73
  - 3/4" F1960 PEX x 3/4" F1960 PEX Trunk 73
  - 3/4" F1960 PEX x Closed Trunk 72
- 1/2" F1960 Branch, Manifold 70-72
  - 1" CPVC x Spun Closed Trunk 72
  - 1" MSWT x Spun Closed Trunk 71
  - 3/4" F1960 x Spun Closed Trunk 70
  - 3/4" F1960 x 3/4" F1960 Trunk 70
  - 3/4" MSWT x Spun Closed Trunk 70-71
- 1/2" F1960 Branch, Poly Manifold 77
  - 1" F1960 x 1" F1960 Trunk 77
  - 1" F1960 x Closed Trunk 77
  - 3/4" F1960 x 3/4" F1960 Trunk 77
  - 3/4" F1960 x Closed Trunk 77
- 1/2" F1960 Branch, Poly Multi-Port Tee 77
- 1/2" F1960 Valved Branch, Manifold 72
- 1/2" Male Sweat Branch, Manifold 126
  - 1" MSWT x 1" FSWT Trunk 126
  - 1" MSWT x 1" MSWT Trunk 126
- 1/2" MIP Branch, Manifold 127-128
  - 1" MSWT x 1" FSWT Trunk 128
  - 1" MSWT x 1" MSWT Trunk 127

- 1/2" MIP/FSWT Ball Valve Branch, Manifold 128
  - 1" MSWT x 1" FSWT Trunk 128
  - 1" MSWT x 1" MSWT Trunk 128
- 1/2" Push Fit Branch, Manifold 141
  - 3/4" Push Fit x Spun Closed Trunk 141
  - 3/4" Push Fit x 3/4" Push Fit Trunk 141
- 10" Roof Drain 277
- 10" Roof Drain 354
- 10" Weir Roof Drain 278
- 11" Roof Drain 277
- 11" Roof Drain 353
- 12" Diameter 256-257
  - Cast Iron - No-Hub Connection 256
  - Cast Iron - Push-Joint Connection 257
- 12" x 12" x 10" 267
- 12" x 12" x 6" 265
- 12" x 12" x 8" 266
- 12" x 8" 270
- 15" Adjustable Weir Roof Drain 276
- 15" Roof Drain - Alpha Series 275
- 15" Roof Drain - Bravo Series 275-276
- 15" Roof Drain & Overflow - Alpha Series 280
- 15" Roof Drain & Overflow - Bravo Series 280-281

**2**

- 20" Large-Capacity Roof Drain 278-279
- 2-Hole Tube Strap 489

**3**

- 3/4" Female Sweat Branch, Manifold 127
- 3/4" Male Sweat Branch, Manifold 126-127
  - 1-1/2" MSWT x 1-1/2" FSWT Trunk 127
  - 1-1/4" MSWT x 1-1/4" MSWT Trunk 126
- 2" MSWT x 2" MSWT Trunk 127

**8**

- 8" Roof Drain 278
- 8" Roof Drain & Overflow 281
- 8" Roof Drain & Overflow - Cast Iron Dome 355
- 8" x 6" 269
- 8" x 8" x 6" 268
- 825 Series - Offset Receptor-Base Style 419
- 825 Series - Receptor-Base Style 419
- 826 Series - Outer-Locknut Style 420
- 840 Series Floor Drains 429

**9**

- 9" Diameter 255-256
  - Cast Iron - No-Hub Connection 255
  - Cast Iron - Push-Joint Connection 255-256
- 90 - F1807 Elbows 18
- 90 - F1960 Elbows 57
- 90 - F1960 Poly Elbows 74
- 90 - F2159 Elbows 51
- 90 Elbow - PDQ™ Push Fit 133

**A**

- Above-Grade Floor Drains 247-252
  - Cast Iron - No-Hub Connection 247-249
  - Cast Iron - Push-Joint Connection 250-252
- Above-Grade Floor Drains 333-336
  - ABS on Iron - No-Hub Connection 335
  - ABS on Iron - Push-Joint Connection 336
  - PVC/ABS - Sch. 40 Hub Connection 333-334
- Abrasive Cleaning Pads 780
- Abrasive Mesh/Cloth 780
- ABS - MIP Thread Connection 360-361
- ABS on Iron - No-Hub Connection 328-330
  - 5-1/2" Tops 329-330
  - 6-1/2" Tops 328-329
- ABS on Iron - No-Hub Connection 335
- ABS on Iron - Push-Joint Connection 330-332
  - 5-1/2" Tops 332
  - 6-1/2" Tops 330-331
- ABS on Iron - Push-Joint Connection 336
- ABS Sch. 40 Hub Connection 453
- Access Cover Cleanouts 296-297
  - Cast Iron - No-Hub Connection 296
  - Cast Iron - Push-Joint Connection 296
  - Heavy-Duty Cleanout Housing 297
- Access Cover Cleanouts 364
- Access Grommet Removal Tool 772
- Access Tools 209
- Accessories 380
- Accessories 453
- Accessories 457
  - Condensate Trap 457
  - Pipe Bore Adapter 457
  - PVC Vent Cap 457
  - SmartSaddle™ 457
- Acid/Cement Brushes 779

# Alphabetical Index

Supply

Drainage

Support

Specialties

Appendix

- Acoustical Isolation Accessories 538
- Acoustical TD+™ Universal Clamps 537
- Adapter - Elbow - CPVC 92
- Adapter - Elbow - F1807 22-24
  - 3/4" FIP Swivel 23
  - Female Sweat 24
  - Male Sweat 24
  - MIP 22
  - Tub/Shower Elbow 23
- Adapter - Elbow - F1960 61-62
  - Female Sweat 62
  - Male Sweat 62
  - MIP 61
  - Tub/Shower Elbow 61
- Adapter - Elbow - F1960 Poly 76
- Adapter - Elbow - F2159 53
  - FIP Swivel Elbow 53
  - MIP Elbow 53
- Adapter - Elbow - PDQ™ Push Fit 136
  - FIP 136
  - MIP 136
- Adapter - Elbow - Sweat 112
- Adapter - Elbow - Sweat Leaded 111
- Adapter - Straight - CPVC 89-91
  - F1807 89
  - F1960 89
  - F3347 89
  - FIP 90
  - Male Sweat 90
  - MIP 90
  - Press-Fitting 91
- Adapter - Straight - CPVC Leaded 91
- Adapter - Straight - F1807 20-22
  - CPVC - IPS Gray 20
  - CPVC, CTS 20
  - Female Sweat 21
  - FIP 22
  - Male Sweat 21
  - MIP 22
  - PVC 20
- Adapter - Straight - F1807 25
  - Compression 25
  - Polybutylene (PB) (ASTM F1380) × PEX 25
- Adapter - Straight - F1960 58-61
  - CPVC - IPS Gray 59
  - CPVC, CTS 58
  - Female Sweat 60
  - FIP 61
  - Male Sweat 59
  - MIP 60
  - PVC 59
- Adapter - Straight - F1960 Poly 76
- Adapter - Straight - F2159 53
  - FIP Swivel 53
  - MIP 53
- Adapter - Straight - F3347 81
- Adapter - Straight - PDQ™ Push Fit 135-136
  - FIP 136
  - FIP Swivel Adapter 136
  - MIP 135
- Adapter - Straight - PVC 105-106
  - F1807 105
  - F1960 105
  - FIP 106
  - Male Sweat 105
  - MIP 106
  - Press-Fitting and Push Fit Compatible 106
- Adapter - Straight - Sch 40 CPVC 101-102
  - F1807 101
  - F1960 101
  - FIP 102
  - Male Sweat 101
  - MIP 101
- Adapter - Sweat/MIP 111
- Adapter - Trap Primer 162
- Add-A-Line™ 121
- Add-A-Line™ 139
- Add-A-Shower 641
  - Add-A-Rod 641
  - Add-A-Shower 641
- Add-A-Valve Fitting 613
- Adjustable Access Cover 365
- Adjustable Cleanouts 291-295
  - Cast Iron - No-Hub Connection 291-293
  - Cast Iron - Push-Joint Connection 293-295
- Adjustable Cleanouts 360-361
- ABS - MIP Thread Connection 360-361
- PVC/ABS - Sch. 40 Hub Connection 360
- Adjustable Concealed Arm 309
- Adjustable Floor Drain 320-321
- Adjustable Floor Drain Head 258-259
  - Cast Iron - MIP Thread Connection 259
  - Nickel-Bronze - MIP Thread Connection 258
  - Nickel-Bronze Extended Rim - MIP Thread Connection 258
  - Stainless Steel - MIP Thread Connection 259
- Adjustable Floor Drain Head 321-322
- Adjustable Slab Shower Drain 414
- Adjustable Swivel/Loop 543
- Adjustable/Multi-Purpose Brackets 529-530
  - SimpleStrap™ 529
  - Slider™ 529
  - Support Bracket 530
  - WiderSlider™ 529
- Air-Admittance Valve Box 203
- Allen Wrench Set 770
- Anchors & Fasteners 495-496
  - Anchors, Screws and Fasteners 495
  - Cable Ties 496
  - Sioux Chief Sammys - Thread Rod Anchors 495
  - Stainless Steel Bands 496
  - StainlessStar™ 496
- Anchors, Screws and Fasteners 495
- ApeTape™ 505
- Appliance Box 177
- Appliance Box - Single 3/4" Male Hose Valve 177
  - Appliance Box 177
  - ProPlate™ 3/4" Outlet 177
- Arrester - HydraRester™ 155-156
  - CPVC 156
  - MIP 155
  - PEX 156
  - Sweat/Press-Fit 155
- Arrester - MegaRester™ 156-157
  - Copper 156
  - Stainless Steel 157
- Arrester - MiniRester™ 153-155
  - Compression Tee 154
  - Female Compression Tee 155
  - Laundry Hose Tee/Toilet Fill Valve Tee 153



PEX Tee 154  
 Straight 153  
 Tub Shower / Stub Out Tee 153-154  
 ASTM F1807 - Fittings, Adapters & Connectors 17-25  
     Cinch Clamp 18  
     Crimp Ring 17  
     F1807 Ballcock Adapter 24  
     F1807 Coupling 19  
     F1807 Elbow 18  
     F1807 Elbow Adapter 22-24  
     F1807 Faucet Adapter 25  
     F1807 Plug 19  
     F1807 Straight Adapter 20-22  
     F1807 Tee 18-19  
     Straight Adapter 25  
     V-Sleeve™ 17  
 ASTM F1807 Accessories 46  
 ASTM F1807 Manifolds 35-44  
     1/2" ComPEX Branch, Manifold 43  
     1/2" F1807 Branch, Manifold 35-42  
     1/2" F1807 Branch, Multi-Port Tee 43-44  
 ASTM F1807 PEX Kits 33-34  
     F1807 Stub Out Kit 33-34  
     F1807 Water Heater Connector Kit 34  
 ASTM F1807 Preformed Copper & Valves 26-32  
     F1807 Brass Ball Valve 30-31  
     F1807 Bullet™ 27  
     F1807 Frost-Proof Anti-Siphon Sillcock 31  
     F1807 Ice Maker Valve 32  
     F1807 Sillcock 31  
     F1807 Stub Out Elbow 26-27  
     F1807 Tub/Shower Pressure Connector 28  
     F1807 Water Heater Connector 28-30  
     F1807 Water Loop 30  
 ASTM F1807 Tools 45-48  
     Crimp Ring Removal Tool 47  
     Crimp Tool 45  
     Plastic Tube Cutter 47  
     Ratchet Tube Cutter 48  
     V-Sleeve™ Compression Tool 47  
 ASTM F1807/F2159 Tools 763-764  
     Crimp Ring Removal Tools 763  
     Crimp Tools 763

V-Sleeve™ Compression Tools 764  
 ASTM F1960 - Metal Fittings, Adapters & Connectors 57-62  
     F1960 Coupling 58  
     F1960 Elbow 57  
     F1960 Elbow Adapter 61-62  
     F1960 Expansion Ring 57  
     F1960 Straight Adapter 58-61  
     F1960 Tee 57-58  
     Wal-Let™ - F1960 62  
 ASTM F1960 - Poly Fittings, Adapters & Connectors 74-76  
     F1960 Expansion Ring 74  
     F1960 Poly Coupling 75  
     F1960 Poly Elbow 74  
     F1960 Poly Elbow Adapter 76  
     F1960 Poly Faucet Adapter 76  
     F1960 Poly Plug 76  
     F1960 Poly Straight Adapter 76  
     F1960 Poly Tee 74-75  
 ASTM F1960 Poly Manifolds 77  
     1/2" F1960 Branch, Poly Manifold 77  
     1/2" F1960 Branch, Poly Multi-Port Tee 77  
 ASTM F1960 Tools 78  
 ASTM F1960 Tools 764  
 ASTM F2159 - Fittings, Adapters & Connectors 51-53  
     Cinch Clamp 51  
     Crimp Ring 51  
     F2159 Poly Coupling 52  
     F2159 Poly Elbow 51  
     F2159 Poly Elbow Adapter 53  
     F2159 Poly Plug 52  
     F2159 Poly Straight Adapter 53  
     F2159 Poly Tee 52  
     V-Sleeve™ 51  
 ASTM F3347 PEX Kits 83  
 ASTM F3347 Preformed Copper & Valves 81-82  
     F3347 Brass Ball Valve 82  
     F3347 Bullet™ 81  
     F3347 Straight Adapter 81  
     F3347 Stub Out Elbow 81  
     F3347 Tub/Shower Pressure Connector 81  
     F3347 Water Heater Connector 82

Backwater Valve 447-448  
 Ball Valve - CPVC - Brass 96  
 Ball Valve - F1807 - Brass 30-31  
 Ball Valve - F1960 - Brass 66  
 Ball Valve - F3347 - Brass 82  
 Ball Valve - PDQ™ Push Fit - Brass 139  
 Ball Valve - PVC - Brass 107  
 Ball Valve - Sweat - Brass 122  
 Ballcock Adapter - F1807 24  
 Barrel Valve Kits 711  
 Bar-Stock & Forged Fittings 698-701  
     Bar-Stock Ball Valves 701  
     Bar-Stock Caps 699  
     Bar-Stock Couplings 698  
     Bar-Stock Elbows 699  
     Bar-Stock Face Bushings 700  
     Bar-Stock Hex Bushings 700  
     Bar-Stock Hex Nipples 700  
     Bar-Stock Locknuts 701  
     Bar-Stock Plugs 701  
     Bar-Stock Reduced Couplings 698  
     Bar-Stock Straight Adapters 699  
     Bar-Stock Street Elbows 699  
     Bar-Stock Tees 698  
     Bar-Stock Union Adapters 698  
     Reducing Hex Nipples 700  
 Bar-Stock Ball Valves 701  
 Bar-Stock Caps 699  
 Bar-Stock Couplings 698  
 Bar-Stock Elbows 699  
 Bar-Stock Face Bushings 700  
 Bar-Stock Hex Bushings 700  
 Bar-Stock Hex Nipples 700  
 Bar-Stock Locknuts 701  
 Bar-Stock Plugs 701  
 Bar-Stock Reduced Couplings 698  
 Bar-Stock Straight Adapters 699  
 Bar-Stock Street Elbows 699  
 Bar-Stock Tees 698  
 Bar-Stock Union Adapters 698  
 Basket Strainers 591-594  
     Ball-Lok™ 591  
     BigBoy™ 591

**B**

Backup Float Valve 448

- Champion® 592
- Designer Series Double Cup 593
- Duo Sink 593
- EezOn™ 592
- Junior™ Bar Sink 594
- KwikFit™ 591
- Lok-Spin® 592
- ProBrite™ 592
- Replacement Baskets 594
- SIG Strainer™ 593
- Specification™ 591
- SweetHeart™ 593
- Basket Strainers & Sink Drains 591-595
  - Basket Strainers 591-594
  - Lav Sink Drains 594-595
- Bath Waste Accessories 602-603
- Bath Waste Drains 599-603
  - Bath Waste Accessories 602-603
  - Brass Waste & Overflows 599-600
  - Plastic Waste & Overflows 600-602
- Beam Clamp & Connector Products 543
- Bell-Trap Floor Drains 429
  - Cast Iron No-Hub Connection 429
  - PVC/ABS Sch. 40 Hub Connection 429
- Bend Supports 521
  - PexChair™ 521
  - SideWinder™ 521
  - Simple Bend Support 521
  - Through-Floor Protective Sleeve 521
- BiFolator™ 484
- Bin Boxes 775
- Black Vinyl Tubing 649
- Boiler Drain 123
- Box Clips, Brackets & Supports 208
- Boxes 207
- Branch Tailpieces 582-584
  - Dishwasher 582-583
  - Lavatory 583
  - LongBranch™ Dishwasher Tailpieces 582
  - MajorTee™ 584
- Brass - Slotted 301
- Brass - Square-Head 301
- Brass Boiler Drain 123
- Brass Closet Flange Rings 441
- Brass Compression Couplings 671
- Brass Compression Elbow Adapters 676-677
  - Ander-Lign Less Insert × MIP 677
  - Ander-Lign Less Insert × FIP 677
  - Ander-Lign With Brass Insert × MIP 677
  - Compression × MIP 676
- Brass Compression Elbows 672
- Brass Compression Fittings 671-679
  - Brass Compression Couplings 671
  - Brass Compression Elbow Adapters 676-677
  - Brass Compression Elbows 672
  - Brass Compression Reducing Couplings 671
  - Brass Compression Straight Adapters 673-676
  - Brass Compression Tees 672
  - Brass Compression to Flare Adapters 676
  - Caps 678
  - Ferrules 678
  - Nuts & Inserts 679
  - Pilot Line Breakaway Compression Nut 679
- Brass Compression Reducing Couplings 671
- Brass Compression Straight Adapters 673-676
  - Ander-Lign Less Insert × FIP 675
  - Ander-Lign Less Insert × MIP 674
  - Ander-Lign With Brass Insert × FIP 675
  - Ander-Lign With Brass Insert × MIP 673-674
  - Compression × FIP 675
  - Compression × MIP 673
  - Female Compression 673
  - Female Compression × MIP 674
  - Female Compression × FIP 676
  - FSWT Adapters 676
- Brass Compression Tees 672
- Brass Compression to Flare Adapters 676
- Brass Fine Thread Flare Caps 692
- Brass Fine Thread Flare Compression Adapters 692
- Brass Fine Thread Flare Couplings 691
- Brass Fine Thread Flare Elbow Adapters 691
- Brass Fine Thread Flare Nut 692
- Brass Fine Thread Flare Straight Adapters 691
  - FIP 691
  - MIP 691
- Brass Fine Thread Flare Tees 691
- Brass Flare Caps 690
- Brass Flare Couplings 687
- Brass Flare Elbow Adapters 689-690
  - FIP 690
  - MIP 689
- Brass Flare Elbows 688
- Brass Flare Fittings 687-692
  - Brass Fine Thread Flare Caps 692
  - Brass Fine Thread Flare Compression Adapters 692
  - Brass Fine Thread Flare Couplings 691
  - Brass Fine Thread Flare Elbow Adapters 691
  - Brass Fine Thread Flare Nut 692
  - Brass Fine Thread Flare Straight Adapters 691
  - Brass Fine Thread Flare Tees 691
  - Brass Flare Caps 690
  - Brass Flare Couplings 687
  - Brass Flare Elbow Adapters 689-690
  - Brass Flare Elbows 688
  - Brass Flare Nuts 690
  - Brass Flare Plugs 691
  - Brass Flare Reducing Couplings 687
  - Brass Flare Straight Adapters 688-689
  - Brass Flare Swivel Unions 687
  - Brass Flare Tees 687
- Brass Flare Nuts 690
- Brass Flare Plugs 691
- Brass Flare Reducing Couplings 687
- Brass Flare Straight Adapters 688-689
  - FIP 689
  - MIP 688
- Brass Flare Swivel Unions 687
- Brass Flare Tees 687
- Brass Garden Hose Blowout Fittings 739
- Brass Garden Hose Cap 738
- Brass Garden Hose Couplings 737
- Brass Garden Hose Elbow 737
- Brass Garden Hose Elbow Adapters 738
- Brass Garden Hose Fittings 737-739
  - Brass Garden Hose Blowout Fittings 739
  - Brass Garden Hose Cap 738
  - Brass Garden Hose Couplings 737
  - Brass Garden Hose Elbow 737
  - Brass Garden Hose Elbow Adapters 738

- Brass Garden Hose Straight Adapters 737-738  
 Brass Garden Hose Washer 739  
 Brass Garden Hose Wye 739  
 Brass Garden Hose Straight Adapters 737-738  
   Compression 738  
   FIP 737  
   Hose Barb 738  
   MIP 737  
 Brass Garden Hose Washer 739  
 Brass Garden Hose Wye 739  
 Brass Hose Barb Couplings 725  
 Brass Hose Barb Elbows 725  
 Brass Hose Barb Ferrule 727  
 Brass Hose Barb Fittings 725-727  
   Brass Hose Barb Couplings 725  
   Brass Hose Barb Elbows 725  
   Brass Hose Barb Ferrule 727  
   Brass Hose Barb Straight Adapters 725-726  
   Brass Hose Barb Valves 727  
 Brass Hose Barb Straight Adapters 725-726  
   FIP 726  
   MIP 725-726  
 Brass Hose Barb Valves 727  
 Brass Stop & Waste Valve 123  
 Brass Waste & Overflows 599-600  
   Chain & Stopper 600  
   Ezy Touch® 599  
   Standing Waste 600  
   Trip Lever 599  
   Twist-N-Close™ 599  
 Brushes & Abrasives 779-780  
   Abrasive Cleaning Pads 780  
   Abrasive Mesh/Cloth 780  
   Acid/Cement Brushes 779  
   Fitting Brushes 779  
   Tube OD Brush 780  
 Bullet - F1807 Stub Out 27  
 Bullet - F1960 Stub Out 64  
 Bullet - F3347 Stub Out 81  
 Bullet - Sweat 115-116  
   Male Sweat 115  
   MIP 116
- C**
- Cable Ties 496  
 Cap - PDQ™ Push Fit 135  
 Caps 678  
 Carrier - Closet 305-308  
 Carrier - Lavatory 309  
 Carrier Bracket 533  
 Cast Brass Fittings 705-708  
   Cast Red Brass Caps 707  
   Cast Red Brass Couplings 705  
   Cast Red Brass Elbows 706  
   Cast Red Brass Hex Bushings 707  
   Cast Red Brass Hex Nipples 707  
   Cast Red Brass Locknuts 708  
   Cast Red Brass Plugs 708  
   Cast Red Brass Reducing Couplings 705  
   Cast Red Brass Straight Adapters 707  
   Cast Red Brass Street Elbows 706  
   Cast Red Brass Tees 706  
   Cast Red Brass Union Adapters 705  
 Cast Iron - FIP Connection 283  
 Cast Iron - No-Hub Connection 237-239  
   5-1/2" Tops 238  
   6-1/2" Tops 237  
   9" Tops 239  
 Cast Iron - No-Hub Connection 242-244  
   5-1/2" Tops 243-244  
   6-1/2" Tops 242-243  
 Cast Iron - No-Hub Connection 247-249  
   Cast Iron Strainer 249  
   Nickel-Bronze Ring & Strainer 247-248  
   Nickel-Bronze Ring & Strainer - Extended Rim 248  
   Stainless Steel Ring & Strainer 248-249  
 Cast Iron - No-Hub Connection 287-288  
   6-1/2" Tops 287  
   9" Tops 288  
 Cast Iron - No-Hub Connection 291-293  
   Ductile Iron Cover 292  
   Ductile Iron Cover with Nickel-Bronze Veneer 292  
   Ductile Iron Cover with Stainless Steel Veneer 293  
   Nickel-Bronze Cover 291  
   Stainless Steel Cover 291  
 Cast Iron - No-Hub Connection 296  
 Cast Iron - Push-Joint Connection 239-240  
   Cast Iron - Push-Joint Connection 244-246  
     5-1/2" Tops 246  
     6-1/2" Tops 244-245  
   Cast Iron - Push-Joint Connection 250-252  
     Cast Iron Strainer 252  
     Nickel-Bronze Ring & Strainer 250  
     Nickel-Bronze Ring & Strainer - Extended Rim 251  
     Stainless Steel Ring & Strainer 251  
   Cast Iron - Push-Joint Connection 288-289  
   Cast Iron - Push-Joint Connection 293-295  
     Ductile Iron Cover 294  
     Ductile Iron Cover with Nickel-Bronze Veneer 295  
     Ductile Iron Cover with Stainless Steel Veneer 295  
     Nickel-Bronze Cover 293  
     Stainless Steel Cover 294  
   Cast Iron - Push-Joint Connection 296  
   Cast Iron Closet Flanges 441  
   Cast Iron Floor Drains 431  
     Philadelphia Style Fresh Air Vent 431  
     Pittsburgh Style Floor Drain 431  
     St. Louis Style Floor Drain 431  
   Cast Iron Round Floor Sinks 269-270  
     12" x 8" 270  
     8" x 6" 269  
   Cast Iron Shower Drains 416  
     2-Piece Drain with Stamped Stainless Steel Strainer 416  
     3-Piece Drain with Grid-Pattern Head & Strainer 416  
   Cast Iron Square Floor Sinks 265-268  
     12" x 12" x 10" 267  
     12" x 12" x 6" 265  
     12" x 12" x 8" 266  
     8" x 8" x 6" 268  
   Cast Red Brass Caps 707  
   Cast Red Brass Couplings 705  
   Cast Red Brass Elbows 706  
   Cast Red Brass Hex Bushings 707  
   Cast Red Brass Hex Nipples 707  
   Cast Red Brass Locknuts 708  
   Cast Red Brass Plugs 708  
   Cast Red Brass Reducing Couplings 705  
   Cast Red Brass Straight Adapters 707  
   Cast Red Brass Street Elbows 706  
   Cast Red Brass Tees 706

Cast Red Brass Union Adapters 705  
 Cast Ring & Strainers 422-423  
     Round Pattern 422-423  
     Square Pattern 423

Center Outlets 564

Center Outlets 579

ChaseBracket™ 533

Cheater Vent 627

Chemicals 787

Cinch Clamp 18

Cinch Clamp 51

ClassicBox™ 3/4" Outlet 173

Cleanout - Commercial 359-369

Cleanout - Specification 287-300

Cleanout Accessories 372-373

Cleanout Bushing 369

    Inside-Pipe Cleanout Bushing 369

    Inside-Pipe Cleanout Fitting 369

Cleanout Cover Accessories 367-368

Cleanout Cover Kits 300

Cleanout Cover Kits 367

Cleanout Covers 300

Cleanout Covers 366

    ABS Covers 366

    Stainless Steel Covers 366

Cleanout Ferrules 299

Cleanout Fittings 299

    Cleanout Ferrules 299

    Cleanout Tees 299

Cleanout Plugs 301

    Brass - Slotted 301

    Brass - Square-Head 301

Cleanout Plugs 370-371

    Polypropylene - Slotted 370

    Polypropylene - Square-Head 371

    PVC - Spanner 371

Cleanout Tees 299

Clear Vinyl Tubing 647-649

    Clear Braided 648-649

    Clear Standard Tubing 647-648

Clevis hanger 544

Closet Bolt Cover Cap 632

Closet Bolts 631

Closet Bowl Gaskets 632-633

    Wax 632

    Waxless Foam 633

Closet Carrier Accessories 307-308

Closet Carriers 305-308

    Closet Carrier Accessories 307-308

    Horizontal 305-306

    Vertical 306-307

Closet Flange Floor Support 443

Closet Flange Floor Support 636

Closet Specialties 631-636

    Closet Bolt Cover Cap 632

    Closet Bolts 631

    Closet Bowl Gaskets 632-633

    Closet Flange Floor Support 636

    ELJER Touch Flush KIT 634

    Misc Closet Repair 636

    PlumbPerfect™ 631

    QuickSpacer™ 635

    Raise-A-Ring™ 635

    Ringer™ 635

    Save-A-Flange™ 636

    SmartCap™ 631

    Tank Handles 635

    Tank-To-Bowl Repair 633

    Toilet Tank Fill Valves 634

    Toilet Tank Flush Valves 634

    Two-Piece Repair Ring 635

    Wedgelt™ 632

Cock Adapter - F1807 24

Combination Roof Drain & Overflow 280-281

    15" Roof Drain & Overflow - Alpha Series

    280

    15" Roof Drain & Overflow - Bravo Series

    280-281

    8" Roof Drain & Overflow 281

Commercial Alignment Bracket 534

Commercial Brackets 533-538

    Acoustical Isolation Accessories 538

    Acoustical TD+™ Universal Clamps 537

    Carrier Bracket 533

    ChaseBracket™ 533

    Commercial Alignment Bracket 534

    CTS Bell Hanger 533

    PipeTitan™ 534

PowerBar™ Mini Strut 535

SaddleUp™ 535-536

TD+™ Plenum-Rated Universal Clamps 537

TD+™ Universal Clamps 536

Concealed Arm 309

Condensate Funnel - Outlet Box 208

Condensate Funnels 261

Condensate Funnels 341

Condensate Trap 457

Cooler Fittings 752

    Cooler Valve 752

    FIP × MIP Adapter 752

Copper Tube Cushion Clamps 545

Copper Tube Cutters 767

Coupling - F1807 19

Coupling - F1960 58

Coupling - F1960 Poly 75

Coupling - F2159 52

Coupling - PDQ™ Push Fit 134

Coupling - Slip - PDQ™ Push Fit 135

Coupling - Sweat 113

CPVC - Fittings, Adapters & Connectors 89-92

    CPVC Elbow Adapter 92

    CPVC Short-N-Swivel™ Straight Adapter 91

    CPVC Straight Adapter 89-91

    CPVC Straight Adapter 91

    Wal-Let™ - CPVC 92

CPVC - Sch 40 - Straight Adapter 101-102

    F1807 101

    F1960 101

    FIP 102

    Male Sweat 101

    MIP 101

CPVC - Sch 40 - Stub Out Elbows 102

CPVC × FIP swivel 91

CPVC Brass Ball Valve 96

CPVC Elbow Adapter 92

CPVC Frost-Proof Anti-Siphon Sillcock 96

CPVC Kits 97-98

    CPVC ShowerUp™ Kit 97

    CPVC Stub Out Elbow Kit 97-98

    CPVC Water Heater Connector Kit 98

CPVC Preformed Copper & Valves 93-96

CPVC Brass Ball Valve 96  
 CPVC Frost-Proof Anti-Siphon Sillcock 96  
 CPVC Sillcock 96  
 CPVC Stub Out Elbow 93  
 CPVC Tub/Shower Pressure Connector 93  
 CPVC Water Heater Connector 94-95  
 CPVC Short-N-Swivel™ Straight Adapter 91  
 CPVC ShowerUp™ Kit 97  
 CPVC Sillcock 96  
 CPVC Straight Adapter 89-91  
     F1807 89  
     F1960 89  
     F3347 89  
     FIP 90  
     Male Sweat 90  
     MIP 90  
     Press-Fitting 91  
 CPVC Straight Adapter 91  
 CPVC Straight Adapter - IPS Gray 101-102  
     F1807 101  
     F1960 101  
     FIP 102  
     Male Sweat 101  
     MIP 101  
 CPVC Stub Out Elbow 93  
     Square O Strap 93  
     Standard 93  
 CPVC Stub Out Elbow - IPS Gray 102  
 CPVC Stub Out Elbow Kit 97-98  
     1/2" Lav/Sink Stub Outs With Bracket 97  
     1/2" Shower Riser Elbow With Bracket 98  
     1/2" Water Closet Stub Out With Bracket 97  
     3/4" Water Heater Stub Outs With Bracket 98  
 CPVC Tub/Shower Pressure Connector 93  
 CPVC Water Heater Connector 94-95  
     FIP Swivel Elbow 94  
     FIP Swivel Straight 94  
     Flexible Copper FIP Swivel 95  
     MIP Straight 95  
     Straight FIP Swivel With Expansion Tank Branch 95  
     T&P Relief Adapter 95  
 CPVC Water Heater Connector Kit 98  
 Crimp Ring 17

Crimp Ring 51  
 Crimp Ring Removal Tool 47  
 Crimp Rings 17  
 Crimp Rings 17  
 Crimp Rings 41  
 Crimp Tool 45  
 Crimping Tool 763  
 Cross Adapters 120  
 CTS Bell Hanger 533

**D**

Debris Covers 207  
 Deburring Tool 769  
 DeckAnchor™ Fixture Mounting Fitting 260  
 Deluxe Matte Stainless Ring & Strainer 410-411  
 Deluxe Nickel-Bronze Ring & Strainer 408-409  
 Deluxe Oil-Rubbed Bronze Finish Ring & Strainer 411  
 Deluxe Polished Stainless Ring & Strainer 409  
 Deluxe Satin Nickel Finish Ring & Strainer 410  
 Dishwasher Supply & Kits 618  
 Dishwasher Tailpieces 566-567  
 Dishwasher/Disposal Drain 626-627  
     Auto Vent 627  
     Dishwasher Adapter 626  
     Dishwasher Air Gaps 627  
     Disposal Drain 627  
     Drain Hose 626  
 Dishwasher/Disposal Drain 657  
 Disposer Waste 565  
 Disposer Waste 579  
 Drain Channels 379  
 Drain Cocks 752  
 DropKick™ 440  
 DrySeal™ Pipe Collar 640  
 Dual-Fit Test Caps 466  
 DWV Backwater Valve 448

**E**

EasyClamps 747  
 Edge™ Support System 517  
 Elbow - F1807 18  
 Elbow - F1960 57  
 Elbow - F1960 Poly 74  
 Elbow - F2159 51  
 Elbow - PDQ™ Push Fit 133  
 Elbow - Stub Out - CPVC 93

Square O Strap 93  
 Standard 93  
 Elbow - Stub Out - F1807 26-27  
     Double Stub Out 27  
     Square O Strap 26  
 Elbow - Stub Out - F1960 63  
     Double Stub Out 63  
     Square O Strap 63  
 Elbow - Stub Out - F3347 81  
 Elbow - Stub Out - Sweat 113-114  
     Double Stub Out 114  
     Male Sweat Offset 114  
     Square O Strap 114  
 Elbow - Tub Spout - Sweat 114-115  
 Elbow Adapter 112  
 Elbow Adapter - PDQ™ Push Fit 136  
     FIP 136  
     MIP 136  
 Elbow Adapter - Sweat 112  
 Elbow Adapter - Sweat Leaded 111  
 Electronic Trap Primer 162-163  
     Recessed Box 163  
     Single Outlet Primer 163  
     Surface Mount Box & Panel 162  
 ELJER Touch Flush KIT 634  
 Emery Cloth 780  
 End Outlets 563-564  
     Non-Telescoping 564  
     Telescoping 563  
 End Outlets 578  
 Expander Tool 764  
 Expansion Ring - F1960 57  
 Expansion Tank Support Kits 553  
 Expansion Tools 78  
 Extension Hangers 501-502  
     Gas Vent Pipe Support 501  
     HangsTuff™ 501  
     Metal DWV Hanger 502  
     StickEm Up™ 502  
     Swivel J-Hanger™ 501  
     ZipStick™ 502  
 Extensions 566  
 Extensions 581

Supply

Drainage

Support

Specialties

Appendix

# Alphabetical Index

Supply

Drainage

Support

Specialties

Appendix

EZ Glide™ Suspension Clamp 482-483  
EZ Glide™ Tube Clamp 482  
EZ Glide™ Tube Insulator 483

## F

F1807 Ballcock Adapter 24  
F1807 Brass Ball Valve 30-31  
F1807 Bullet™ 27  
F1807 Coupling 19  
F1807 Elbow 18  
F1807 Elbow Adapter 22-24  
    3/4" FIP Swivel 23  
    Female Sweat 24  
    Male Sweat 24  
    MIP 22  
    Tub/Shower Elbow 23  
F1807 Faucet Adapter 25  
F1807 Frost-Proof Anti-Siphon Sillcock 31  
F1807 Ice Maker Valve 32  
F1807 Plug 19  
F1807 Sillcock 31  
F1807 Straight Adapter 20-22  
    CPVC - IPS Gray 20  
    CPVC, CTS 20  
    Female Sweat 21  
    FIP 22  
    Male Sweat 21  
    MIP 22  
    PVC 20  
F1807 Stub Out 27  
F1807 Stub Out Elbow 26-27  
    Double Stub Out 27  
    Square O Strap 26  
F1807 Stub Out Kit 33-34  
    1/2" Lav/Sink Stub Outs With Bracket 33  
    1/2" Shower Riser Elbow With Bracket 34  
    1/2" Water Closet Stub Out With Bracket 33  
    3/4" Water Heater Stub Outs With Bracket 34  
F1807 Tee 18-19  
F1807 Tub/Shower Pressure Connector 28  
F1807 Water Heater Connector 28-30  
    FIP Swivel Elbow 28  
    FIP Swivel Straight 29  
    FIP Swivel With FIP Tee 30

FIP Swivel With MIP Branch 30  
Flexible Copper, FIP Swivel 29  
F1807 Water Heater Connector Kit 34  
F1807 Water Loop 30  
F1960 Brass Ball Valve 66  
F1960 Brass Ball Valve 66  
F1960 Bullet™ 64  
F1960 Coupling 58  
F1960 Elbow 57  
F1960 Elbow Adapter 61-62  
    Female Sweat 62  
    Male Sweat 62  
    MIP 61  
    Tub/Shower Elbow 61  
F1960 Expansion Ring 57  
F1960 Expansion Ring 74  
F1960 Frost-Proof Anti-Siphon Sillcock 67  
F1960 Poly Coupling 75  
F1960 Poly Elbow 74  
F1960 Poly Elbow Adapter 76  
F1960 Poly Faucet Adapter 76  
F1960 Poly Plug 76  
F1960 Poly Straight Adapter 76  
F1960 Poly Tee 74-75  
F1960 Sillcock 66  
F1960 Straight Adapter 58-61  
    CPVC - IPS Gray 59  
    CPVC, CTS 58  
    Female Sweat 60  
    FIP 61  
    Male Sweat 59  
    MIP 60  
    PVC 59  
F1960 Stub Out 64  
F1960 Stub Out Elbow 63  
    Double Stub Out 63  
    Square O Strap 63  
F1960 Stub Out Kit 68-69  
    1/2" Lav/Sink Stub Outs With Bracket 68  
    1/2" Shower Riser Elbow With Bracket 69  
    1/2" Water Closet Stub Out With Bracket 68  
    3/4" Water Heater Stub Outs With Bracket 69  
F1960 Tee 57-58

F1960 Tools 78  
F1960 Tub/Shower Pressure Connector 64  
F1960 Water Heater Connector 64-65  
    FIP Swivel Elbow 64  
    FIP Swivel Straight 65  
    Flexible Copper FIP Swivel 65  
F1960 Water Heater Connector Kit 69  
F2159 Poly Coupling 52  
F2159 Poly Elbow 51  
F2159 Poly Elbow Adapter 53  
    FIP Swivel Elbow 53  
    MIP Elbow 53  
F2159 Poly Plug 52  
F2159 Poly Straight Adapter 53  
    FIP Swivel 53  
    MIP 53  
F2159 Poly Tee 52  
F3347 Brass Ball Valve 82  
F3347 Bullet™ 81  
F3347 Straight Adapter 81  
F3347 Stub Out 81  
F3347 Stub Out Elbow 81  
F3347 Stub Out Kit 83  
    1/2" Lav/Sink Stub Outs With Bracket 83  
    1/2" Water Closet Stub Out With Bracket 83  
F3347 Tub/Shower Pressure Connector 81  
F3347 Water Heater Connector 82  
FastTrack™ System 379-380  
    Accessories 380  
    Drain Channels 379  
    Grates 379-380  
FatMax™ Floor Drain Accessories 324  
FatMax™ Floor Sink Accessories 348  
FatMax™ Large-Capacity Floor Drains 255-257  
    12" Diameter 256-257  
    9" Diameter 255-256  
    Stainless Steel 257  
FatMax™ Large-Capacity Floor Drains 323-324  
    FatMax™ Floor Drain Accessories 324  
    LittleMax™ General Purpose Floor Drain 324  
    PVC/ABS - Sch. 40 Hub Connection 323  
FatMax™ PVC Round Floor Sink 347-348  
    FatMax™ Floor Sink Accessories 348

PVC - Sch. 40 Hub Connection 347  
 FatMax™ Stainless Steel Round Floor Sink 271  
 Faucet Adapter - F1807 25  
 Faucet Adapter - F1960 Poly 76  
 Faucet Handle Puller 773  
 Faucet Seat Wrenches 771  
 Faucet Stem Key 771  
 Ferrules 678  
 FinishLine Halo™ Adjustable Cleanouts 298  
 FinishLine Halo™ Adjustable Cleanouts 362-363  
 FinishLine Halo™ Floor Drains 253-254  
 FinishLine Halo™ Floor Drains 338-339  
 FinishLine™ Above-Grade Floor Drains 242-246  
     Cast Iron - No-Hub Connection 242-244  
     Cast Iron - Push-Joint Connection 244-246  
 FinishLine™ Above-Grade Floor Drains 325-332  
     ABS on Iron - No-Hub Connection 328-330  
     ABS on Iron - Push-Joint Connection 330-332  
     PVC/ABS - Sch. 40 Hub Connection 325-327  
 FinishLine™ Adjustable Cleanouts 287-290  
     Cast Iron - No-Hub Connection 287-288  
     Cast Iron - Push-Joint Connection 288-289  
     Stainless Steel - No-Hub Connection 289-290  
 FinishLine™ Adjustable Cleanouts 359  
 FinishLine™ On-Grade Floor Drains 237-241  
     Cast Iron - No-Hub Connection 237-239  
     Cast Iron - Push-Joint Connection 239-240  
     Stainless Steel - No-Hub Connection 241  
 FinishLine™ On-Grade Floor Drains 317-319  
 Fitting Brushes 779  
 Flaring Tool 773  
 Flat Gasket Material 665  
 Flexible Fittings 569  
 Flexible Grabber 773  
 Flexible PVC Spa Hose 658  
 Flexible PVC Test Caps 466  
 Floor Drain Accessories 258-261  
     Adjustable Floor Drain Head 258-259  
     Condensate Funnels 261  
     DeckAnchor™ Fixture Mounting Fitting 260  
     Floor Drain Adapters 260-261  
     TrapShield™ 260  
 Floor Drain Accessories 340-342

Condensate Funnels 341  
 Floor Drain Adapters 341  
 Replacement Strainers 340  
 TrapShield™ 340  
 Vandal-Resistant Strainer Screws 342  
 Floor Drain Adapters 260-261  
     Flashing Drain Adapters - 4" FIP Thread 260  
     No-Hub Adapters 260  
     Push-Joint Adapters 261  
 Floor Drain Adapters 341  
     Flashing Drain Adapters 341  
     Trap Primer Adapters 341  
 Floor Drain Replacement Strainers 432-433  
     General-Purpose Cast Iron Strainers 433  
     Strainers for Bell Trap Drain 432  
     Strainers for City-Style Drains 432-433  
     Strainers for Weld One / Quad Drain 432  
 FlowEasy™ - Liquid Drain Cleaner 787  
 Flush-to-Floor Pipe Drain 430  
 Foam Pipe/Tube Insulation 145-147  
     Half-Slit - Black 146  
     Self-Seal Seam - Black 145  
     White - 1/2" Wall 147  
 Frames, Inserts, & Extensions 208  
 Freestanding Tub Drain 421  
 Freestanding Tub Drain 421  
 Fridge Box 181  
 Frost-Proof Anti-Siphon Sillcock 123-124  
 Frost-Proof Sillcock - CPVC 96  
 Frost-Proof Sillcock - F1807 31  
 Frost-Proof Sillcock - F1960 67  
 Frost-Proof Sillcock - Sweat/MIP 123-124  
 Frost-Proof Sillcock Replacement Parts 124  
 Fuel Line 661  
     Polyester Reinforced Fuel Line 661  
     Polyurethane Micro Fuel Line 661  
 Full Clamp 480  
 Full Slip Male Adapter 111  
 FullFlush™ 440  
     Inside-Pipe Gasket Connection 440  
     PVC/ABS Sch. 40 Hub Connection 440

**G**

Garden Hose 657

Gas Range Fittings 695  
 Gas Service - FIP Outlet 199  
 Gas Specialty Fittings 695  
     Gas Range Fittings 695  
     POL (LPG) Gas Fittings 695  
 Gas Vent Pipe Support 501  
 Gasket Material 665  
 Gasketed Closet Flange 439  
 Gauges & Accessories 471  
     Hand Pump 471  
     Test Gauge Assemblies 471  
     Test Gauges 471  
 General-Purpose Cast Iron Strainers 433  
 General-Purpose Floor Drains 428-429  
     840 Series Floor Drains 429  
     Bell-Trap Floor Drains 429  
     QuadDrain™ 428  
 Grates 379-380  
 Grid-Pattern Head & Strainer 412  
 Gripper™ 430  
 GripTip™ 465  
 GripTip™ 467  
 Ground Stake 509

**H**

Hacksaw 768  
 Halo™ Adjustable Cleanouts 298  
 Halo™ Adjustable Cleanouts 362  
 Halo™ Cleanouts 298  
     FinishLine Halo™ Adjustable Cleanouts 298  
     Halo™ Adjustable Cleanouts 298  
 Halo™ Cleanouts 362-363  
     FinishLine Halo™ Adjustable Cleanouts 362-363  
     Halo™ Adjustable Cleanouts 362  
 Halo™ Floor Drains 253-254  
     FinishLine Halo™ Floor Drains 253-254  
     Halo™ Floor Drains 253  
 Halo™ Floor Drains 253  
 Halo™ Floor Drains 337-339  
     FinishLine Halo™ Floor Drains 338-339  
     Halo™ Floor Drains 337  
 Halo™ Floor Drains 337  
 Halo™ Shower Pan Drain 415  
 Hand Pump 471

HandTite™ 464  
 Hanger Straps 505  
     ApeTape™ 505  
     Metal Hanger Strap 505  
     Plastic Hanger Strap 505  
 HangsTuff Jr.™ 486  
 HangsTuff™ 501  
 HardHat™ 466  
 Heat Trap Loop 121  
 Heater Hose 657  
 Heavy-Duty Cleanout Housing 297  
 Horizontal 305-306  
     Bariatric (1,000 Lb) 306  
     Extra-Heavy (750 Lb) 305  
     Standard (500 Lb) 305  
 Hose 657-658  
     Dishwasher/Disposal Drain 657  
     Flexible PVC Spa Hose 658  
     Garden Hose 657  
     Heater Hose 657  
     Latex Hose 658  
     Suction/Discharge Hose 658  
 Hose Bibb - CPVC 96  
 Hose Bibb - F1807 31  
 Hose Bibb - F1960 66-67  
 Hose Bibb - Push Fit 139-140  
 Hose Bibb - Sweat 123-124  
 Hose Clamps 747  
     EasyClamps 747  
     Stainless Steel Hose Clamps 747  
 HydraRester™ 155-156  
     CPVC 156  
     MIP 155  
     PEX 156  
     Sweat/Press-Fit 155  
 HydroBlock™ 100 397  
 HydroBlock™ 150 397  
 HydroBlock™ 200 397-398  
 HydroBlock™ 300 398  
 HydroBlock™ System 397-398  
     HydroBlock™ 100 397  
     HydroBlock™ 150 397  
     HydroBlock™ 200 397-398

HydroBlock™ 300 398  
 HydroLine™ System 401  
 HydroLine™ System 401  
 HydroTec™ MAXI System 383-388  
     Maxi 100 - 4" Wide 383-384  
     Maxi 150 - 6" Wide 385-386  
     Maxi 200 - 8" Wide 387  
     Maxi 300 - 12" Wide 387-388  
     Maxi 400 - 16" Wide 388  
 HydroTec™ System 383-393  
     HydroTec™ MAXI System 383-388  
     HydroTec™ TOP System 389-393  
 HydroTec™ TOP System 389-393  
     Top 100 - 4" Wide 389-391  
     Top 100 Slot - 4" Wide 391-392  
     Top 150 - 6" Wide 392-393  
     Top 200 - 8" Wide 393

## I

Ice Maker - 1/4" Comp. Outlet 181-182  
     OxBox™ 1/4" Outlet 181  
     OxBox™ 1/4" Outlet, Fire-Rated 182  
     ProPlate™ 1/4" Outlet 182  
 Ice Maker Supply & Kits 618  
 Ice Maker Valve - F1807 32  
 Inflatable Cleanout Tee Plug 464  
 Inflatable Test Plug 465  
 Inside Pipe Cutter 769  
 Inside-Pipe Cleanout Bushing 369  
 Inside-Pipe Cleanout Fitting 369  
 Inspection Mirror 774  
 Insulation - Pipe 145-147  
 Integral-Trap Floor Drains 427  
 IPS F438 CPVC - Fittings, Adapters & Connectors 101-102  
     CPVC Straight Adapter - IPS Gray 101-102  
     CPVC Stub Out Elbow - IPS Gray 102

## J

JackRabbit™ Outer-Locknut Style 420  
 J-Clamp 479  
 J-Hook 486-501

## K

Kitchen Supply - Comp. Multi-Valve Outlet 195-196  
 Knockout Closet Flanges 437  
 Knockout Test Plugs 466

## L

Large-Capacity Shower Pan Drains 414-415  
 Latex Hose 658  
 Laundry - 3/4" Male Hose Outlet 169-173  
     ClassicBox™ 3/4" Outlet 173  
     OmniPanel™ 3/4" Outlet 172  
     OmniPanel™ 3/4" Outlet, Fire-Rated 172  
     OxBox ONE™ 3/4" Outlet 171  
     OxBox ONE™ 3/4" Outlet, Fire-Rated 171  
     OxBox™ 3/4" Outlet 169-170  
     OxBox™ 3/4" Outlet, Fire-Rated 170  
 Laundry Box 169-173  
 Lav Box - 3/8" Comp. Outlet 189-191  
     OmniPanel™ 3/8" Outlets 190  
     OmniPanel™ 3/8" Outlets, Fire-Rated 191  
     OxBox™ 3/8" Outlets - Dual valve 189  
     OxBox™ 3/8" Outlets, Fire-Rated - Dual Valve 189-190  
     OxBox™ 3/8" Outlets, TMV, Dual Outlet 190  
 Lav Sink Drains 594-595  
     CO Plug Drain 595  
     Industrial Sink Plug 595  
     PO Plug Drain 595  
 Lav/Sink Accessories 627  
 Lav/Sink Specialties 621-627  
     Dishwasher/Disposal Drain 626-627  
     Lav/Sink Accessories 627  
     Metal Escutcheons 622-624  
     Polypropylene Escutcheons 621-622  
     Sink/Faucet Repair 624-625  
 Lav/Sink Supply 617  
 Lavatory Carriers 309  
     Adjustable Concealed Arm 309  
     Concealed Arm 309  
     Plate Type 309  
 Levels 774  
 Lift & Turn 599-602  
 LittleMax™ Compact PVC Round Floor Sink 349  
 LittleMax™ General Purpose Floor Drain 324  
 Low-Density Polyethylene Tubing 653  
 Low-Profile Linear Shower Drain 418  
 Lubricants 783

## M

MainBlock™ 484



Manifold - 1/2" ComPEX Branches 43  
 Manifold - 1/2" F1807 Branches 35-42  
     1" CPVC x Spun Closed Trunk 42  
     1" F1807 x 1" F1807 Trunk 38  
     1" F1807 x Spun Closed Trunk 37  
     1" FSWT x Spun Closed Trunk 41  
     1" MSWT x 1" FSWT Trunk 41-42  
     1" MSWT x 1" MSWT Trunk 40  
     1" MSWT x Spun Closed Trunk 40  
     1/2" F1807 x 3/4" F1807 Trunk 37  
     1/2" F1807 x Closed Trunk 36  
     3/4" F1807 x 1" F1807 Trunk 37  
     3/4" F1807 x 3/4" F1807 Trunk 36  
     3/4" F1807 x Spun Closed Trunk 35  
     3/4" MSWT x 3/4" FSWT Trunk 39  
     3/4" MSWT x 3/4" MSWT, Extended Trunk 39  
     3/4" MSWT x Spun Closed Trunk 38  
 Manifold - 1/2" F1960 Branches 70-72  
     1" CPVC x Spun Closed Trunk 72  
     1" MSWT x Spun Closed Trunk 71  
     3/4" F1960 x Spun Closed Trunk 70  
     3/4" F1960 x 3/4" F1960 Trunk 70  
     3/4" MSWT x Spun Closed Trunk 70-71  
 Manifold - 1/2" F1960 Valved Branches 72  
 Manifold - 1/2" MIP Branches 127-128  
     1" MSWT x 1" FSWT Trunk 128  
     1" MSWT x 1" MSWT Trunk 127  
 Manifold - 1/2" MIP/Female Sweat Ball Valve Branches 128  
     1" MSWT x 1" FSWT Trunk 128  
     1" MSWT x 1" MSWT Trunk 128  
 Manifold - 1/2" Sweat Branches 126  
     1" MSWT x 1" FSWT Trunk 126  
     1" MSWT x 1" MSWT Trunk 126  
 Manifold - 3/4" Male Sweat Branches 126-127  
     1-1/2" MSWT x 1-1/2" FSWT Trunk 127  
     1-1/4" MSWT x 1-1/4" MSWT Trunk 126  
     2" MSWT x 2" MSWT Trunk 127  
 Manifold - Poly - 1/2" F1960 Branches 77  
     1" F1960 x 1" F1960 Trunk 77  
     1" F1960 x Closed Trunk 77  
     3/4" F1960 x 3/4" F1960 Trunk 77  
     3/4" F1960 x Closed Trunk 77  
 Manifold Bracket 539

Manifold Brackets 539  
 Match Holder 774  
 MegaRester™ 156-157  
     Copper 156  
     Stainless Steel 157  
 Metal Access Panel 213  
 Metal CTS/IPS 489-491  
     2-Hole Tube Strap 489  
     Milford Hanger 490  
     Natick Hanger 491  
     Vinyl-coated Steel Clamp with Screw 490  
     Wire Pipe Hook 490  
 Metal DWV Hanger 502  
 Metal Escutcheons 622-624  
     Deep Bell 623  
     Deep Box 623  
     Hinged Floor & Ceiling Plates 624  
     Shallow Escutcheons 622  
 Metal Hanger Strap 505  
 Metal Stud Punch 769  
 Metal Tubular 573-588  
     Branch Tailpieces 582-584  
     Center Outlets 579  
     Disposer Waste 579  
     End Outlets 578  
     Extensions 581  
     Metal Tubular Accessories 587-588  
     P-Traps 573-576  
     Sink Tailpieces 579-580  
     S-Traps 577  
     Threaded Tube 585  
     Trap Accessories 577-578  
     Tubular Fittings 586  
     Waste Arms 584-585  
 Metal Tubular Accessories 587-588  
     Desanco Fittings & Adapters 588  
     Nuts & Washers 587  
     Sink Funnel 588  
 Milford Hanger 490  
 MiniRester™ 153-155  
     Compression Tee 154  
     Female Compression Tee 155  
     Laundry Hose Tee/Toilet Fill Valve Tee 153

PEX Tee 154  
 Straight 153  
 Tub Shower / Stub Out Tee 153-154  
 MIP Thread Connection 451  
 Misc Closet Repair 636  
 Mixing Valve 125  
 Moen Cartridge Puller 773  
 Multi Clip 485  
 Multi-Port Tee - 1/2" F1807 Branches 43-44  
     3/4" F1807 x 3/4" F1807 Trunk 44  
     3/4" F1807 x Closed Trunk 43  
 Multi-Port Tee - 1/2" F1960 Branches 72-73  
     3/4" F1960 PEX x 3/4" F1960 PEX Trunk 73  
     3/4" F1960 PEX x Closed Trunk 72  
 Multi-Port Tee - Poly - 1/2" F1960 Branches 77  
 Multi-Turn Angle Stops 612  
 Multi-Turn Straight Stops 613

**N**

Natick Hanger 491  
 Needle Valves - Angled 751  
 Needle Valves - Saddle Valves 752  
 Needle Valves - Straight 751  
 Nickel-Bronze Downspout Nozzles 284  
 No-Caulk Connection 419  
 Non-Adjustable Floor Drain 322  
 Nuts & Inserts 679  
 Nylon Compression Fittings 683-684  
     Nylon Couplings 683  
     Nylon Elbow Adapters 684  
     Nylon Elbows 683  
     Nylon Reducing Couplings 683  
     Nylon Straight Adapters 683  
     Nylon Tees 683  
 Nylon Couplings 683  
 Nylon Elbow Adapters 684  
 Nylon Elbows 683  
 Nylon Garden Hose Cap 744  
 Nylon Garden Hose Couplings 743  
 Nylon Garden Hose Fittings 743-744  
     Nylon Garden Hose Cap 744  
     Nylon Garden Hose Couplings 743  
     Nylon Garden Hose Straight Adapters 743-744  
 Nylon Garden Hose Straight Adapters 743-744

# Alphabetical Index

Supply

Drainage

Support

Specialties

Appendix

FIP 743

Hose Barb 744

MIP 743

Nylon Hose Barb Couplings 731

Nylon Hose Barb Elbow Adapters 733

Nylon Hose Barb Elbows 731

Nylon Hose Barb Fittings 731-733

Nylon Hose Barb Couplings 731

Nylon Hose Barb Elbow Adapters 733

Nylon Hose Barb Elbows 731

Nylon Hose Barb Reducing Couplings 731

Nylon Hose Barb Straight Adapters 732-733

Nylon Hose Barb Tees 731-732

Nylon Hose Barb Reducing Couplings 731

Nylon Hose Barb Straight Adapters 732-733

FIP 733

MIP 732-733

Nylon Hose Barb Tees 731-732

Nylon Reducing Couplings 683

Nylon Straight Adapters 683

Nylon Tees 683

Nylon Thread Couplings 711

Nylon Thread Elbows 712

Nylon Thread Fittings 711-712

Barrel Valve Kits 711

Nylon Thread Couplings 711

Nylon Thread Elbows 712

Nylon Thread Hex Bushings 712

Nylon Thread Hex Nipples 712

Nylon Thread Plugs 712

Nylon Thread Tees 711

Thread Bulkhead Union Adapters 711

Nylon Thread Hex Bushings 712

Nylon Thread Hex Nipples 712

Nylon Thread Plugs 712

Nylon Thread Tees 711

## O

Offset Closet Flanges 440

DropKick™ 440

FullFlush™ 440

Offset Riser 116-117

OmniPanel™ 3/4" Outlet 172

Arrester 172

Non-Arrester 172

OmniPanel™ 3/4" Outlet, Fire-Rated 172

Arrester 172

Non-Arrester 172

OmniPanel™ 3/8" Outlets 190

Arrester 190

Non-Arrester 190

OmniPanel™ 3/8" Outlets, Fire-Rated 191

Arrester 191

Non-Arrester 191

On-Grade Floor Drains 320-322

Adjustable Floor Drain 320-321

Adjustable Floor Drain Head 321-322

Non-Adjustable Floor Drain 322

Open Closet Flanges 438

Open Flanges 438

O-Ring Pick 773

Outlet Box 169-173

Outlet Box Accessories 207-209

Access Tools 209

Box Clips, Brackets & Supports 208

Boxes 207

Debris Covers 207

Frames, Inserts, & Extensions 208

Secondary Drainage Funnel 208

Valves 207

Overhead 543-546

Adjustable Swivel/Loop 543

Beam Clamp & Connector Products 543

Clevis hanger 544

Copper Tube Cushion Clamps 545

PipeEye™ Suspension Bracket 543

Sioux Chief Sammys - Thread Rod Anchors 546

Split Ring Hanger 544-545

Strut Clamps 545

OverUnder™ Access Panel 213

OxBox ONE™ 3/4" Outlet 171

Arrester 171

Non-Arrester 171

OxBox ONE™ 3/4" Outlet, Fire-Rated 171

Arrester With Frame 171

Non-Arrester With Frame 171

OxBox™ 1/4" Outlet 181

Arrester 181

Non-Arrester 181

OxBox™ 1/4" Outlet, Fire-Rated 182

Arrester 182

Non-Arrester 182

OxBox™ 3/4" Outlet 169-170

Arrester 169

Non-Arrester 169-170

OxBox™ 3/4" Outlet, Fire-Rated 170

Arrester 170

Non-Arrester 170

OxBox™ 3/8" Outlet, Fire-Rated - Single Valve 185-186

Arrester 185

Non-Arrester 186

OxBox™ 3/8" Outlets - Dual valve 189

Arrester 189

Non-Arrester 189

OxBox™ 3/8" Outlets, Fire-Rated - Dual Valve 189-190

Arrester 189

Non-Arrester 190

OxBox™ 3/8" Outlets, Multi-Valve 195-196

3 Valve Rough-In Outlet 195

3 Valve With Frame Fire-Rated Outlet 196

4 Valve Rough-In Outlet 195-196

4 Valve With Frame Fire-Rated Outlet 196

OxBox™ 3/8" Outlets, TMV, Dual Outlet 190

OxBox™ 3/8" Outlet-Single valve 185

Arrester 185

Non-Arrester 185

OxBox™ Gas 199

Fire-Rated Outlet Box 199

Outlet Box 199

OxBox™ Turbovent™ 203

## P

PadLock™ 481

Panels 213

Metal Access Panel 213

OverUnder™ Access Panel 213

Plastic Access Panel 213

Paste Flux brush 779

PDQ™ Push - Fittings, Adapters & Connectors 133-136

Push Fit Cap 135

Push Fit Coupling 134

- Push Fit Elbow 133
- Push Fit Elbow Adapter 136
- Push Fit Slip Coupling 135
- Push Fit Straight Adapter 135-136
- Push Fit Tee 133
- Push Fit Transition Adapter 134
- Push Fit Transition Tee 134
- PDQ™ Push Fit Manifolds 141
- PDQ™ Push Fitting Accessories 137
  - Poly Tube Stiffener 137
- Push Fit Disconnect Tools 137
- Stainless Steel Tube Stiffener 137
- PDQ™ Push Preformed Copper & Valves 138-140
  - Add-A-Line™ 139
  - Push Fit Brass Ball Valve 139
  - Push Fit Frost-Proof Sillcock 140
  - Push Fit Sillcock 139
  - Push Fit Stub Out Elbow 138
  - Push Fit Tub/Shower Connector 138
  - Push Fit Water Heater Connector Kit 140
  - Push-Fit Water Heater Connector 138-139
- PDQ™ Push-Fit Disconnect Tools 772
- Peg-Board Hook 775
- PEX A Tube - Barrier 14
- PEX B Tube - Barrier 12-13
  - Coils 12-13
  - Sticks 12
- PEX Ballcock Adapter - F1807 24
- PEX Coupling - F1807 19
- PEX Coupling - F1960 58
- PEX Coupling - F1960 Poly 75
- PEX Coupling - F2159 52
- PEX Crimp Removal Tool 47
- PEX Crimp Tools 45
- PEX Elbow - F1807 18
- PEX Elbow - F1960 57
- PEX Elbow - F1960 Poly 74
- PEX Elbow - F2159 51
- PEX Elbow Adapter - F1807 22-24
  - 3/4" FIP Swivel 23
  - Female Sweat 24
  - Male Sweat 24
  - MIP 22
- Tub/Shower Elbow 23
- PEX Elbow Adapter - F1960 61-62
  - Female Sweat 62
  - Male Sweat 62
  - MIP 61
  - Tub/Shower Elbow 61
- PEX Elbow Adapter - F1960 Poly 76
- PEX Elbow Adapter - F2159 53
  - FIP Swivel Elbow 53
  - MIP Elbow 53
- PEX Expansion Tools 78
- PEX Faucet Adapter - F1807 25
- PEX Faucet Adapter - F1960 Poly 76
- PEX Plug - F1807 19
- PEX Plug - F1960 Poly 76
- PEX Plug - F2159 52
- PEX Rings - Crimp 17
- PEX Rings - Crimp 51
- PEX Straight Adapter - F1807 20-22
  - CPVC - IPS Gray 20
  - CPVC, CTS 20
  - Female Sweat 21
  - FIP 22
  - Male Sweat 21
  - MIP 22
  - PVC 20
- PEX Straight Adapter - F1807 25
  - Compression 25
  - Polybutylene (PB) (ASTM F1380) × PEX 25
- PEX Straight Adapter - F1960 58-61
  - CPVC - IPS Gray 59
  - CPVC, CTS 58
  - Female Sweat 60
  - FIP 61
  - Male Sweat 59
  - MIP 60
  - PVC 59
- PEX Straight Adapter - F1960 Poly 76
- PEX Straight Adapter - F2159 53
  - FIP Swivel 53
  - MIP 53
- PEX Straight Adapter - F3347 81
- PEX Tee - F1807 18-19
- PEX Tee - F1960 57-58
- PEX Tee - F1960 Poly 74-75
- PEX Tee - F2159 52
- PexChair™ 521
- Philadelphia Style Fresh Air Vent 431
- PickUp Talon™ 479
- Pilot Line Breakaway Compression Nut 679
- Pipe Bore Adapter 457
- Pipe Insulation 145-147
- Pipe Nipples 715-718
  - Pipe Nipples - Chrome-Plated Yellow Brass 716
  - Pipe Nipples - Red Brass 716-718
  - Pipe Nipples - Yellow Brass 715-716
- Pipe Nipples - Chrome-Plated Yellow Brass 716
- Pipe Nipples - Red Brass 716-718
- Pipe Nipples - Yellow Brass 715-716
- Pipe Strainers 430
  - Flush-to-Floor Pipe Drain 430
  - Gripper™ 430
  - Replacel™ 430
- PipeEye™ 483-484
- PipeEye™ Suspension Bracket 543
- PipeTitan™ 534
- Pittsburgh Style Floor Drain 431
- Planter-Area Drains 356
- Plastic Access Panel 213
  - One-Piece 213
  - Two-Piece 213
- Plastic CTS - tube hangers 479-486
- BiFolator™ 484
- EZ Glide™ Suspension Clamp 482-483
- EZ Glide™ Tube Clamp 482
- EZ Glide™ Tube Insulator 483
- HangsTuff Jr.™ 486
- MainBlock™ 484
- PadLock™ 481
- PickUp Talon™ 479
- PipeEye™ 483-484
- Single Hole Tube Strap 486
- SiouxStrap™ 480
- Suspensulator™ 483
- TD+™ 485
- Totem™ 481

TouchDown™ 485  
 TubeTalon™ 479  
 TwinTalon™ 480  
 Plastic Hanger Strap 505  
 Plastic Tube Cutter 47  
 Plastic Tubular 561-570  
     Center Outlets 564  
     Dishwasher Tailpieces 566-567  
     Disposer Waste 565  
     End Outlets 563-564  
     Extensions 566  
     Flexible Fittings 569  
     Plastic Tubular Accessories 570  
     P-Traps 561-562  
     Sink Tailpiece/Extension 565  
     Sink Tailpieces 565  
     S-Traps 562  
     Trap Accessories 562  
     Tubular Fittings 568  
     Waste Arms 567  
 Plastic Tubular Accessories 570  
 Plastic Waste & Overflows 600-602  
     Cable Drive 600  
     Ezy Touch® 601  
     Trip Lever 600  
     Twist-N-Close™ 602  
 Plate Type 309  
 Plate Type 310  
 Plate Type 311  
 Plug - F1807 19  
 Plug - F1960 Poly 76  
 Plug - F2159 52  
 PlumbPerfect™ 631  
 Plunger 774  
 PO Plug Wrench 771  
 POL (LPG) Gas Fittings 695  
 Poly Tube Cutters 767  
 Poly Tube Stiffener 137  
 Polyester Reinforced Fuel Line 661  
 Polyethylene Tubing 653  
 Polypropylene - Slotted 370  
 Polypropylene - Square-Head 371  
 Polypropylene Escutcheons 621-622

SnapOne™ Escutcheons 621-622  
 TrimTite™ Escutcheons 621  
 Polypropylene Push-Fit Couplings 721  
 Polypropylene Push-Fit Elbow Adapters 722  
 Polypropylene Push-Fit Elbows 721  
 Polypropylene Push-Fit Fittings 721-722  
     Polypropylene Push-Fit Couplings 721  
     Polypropylene Push-Fit Elbow Adapters 722  
     Polypropylene Push-Fit Elbows 721  
     Polypropylene Push-Fit Straight Adapters 722  
     Polypropylene Push-Fit Tees 721  
     Polypropylene Push-Fit Valves 722  
 Polypropylene Push-Fit Straight Adapters 722  
 Polypropylene Push-Fit Tees 721  
 Polypropylene Push-Fit Valves 722  
 Polyurethane Micro Fuel Line 661  
 Pool Hose Couplings 757  
 Pool Hose Cuffs 757  
 Pool Hose Fittings 757  
     Pool Hose Couplings 757  
     Pool Hose Cuffs 757  
 PowerBar™ 525-526  
     Accessories and Bulk Components 526  
     Acoustical 526  
     Universal Slider Bracket 525  
 PowerBar™ Mini Strut 535  
 PowerPex® Coil Unwinder 764  
 PowerPEX® F1960 Manifolds 70-73  
     1/2" F1960 Branch, Multi-Port Tee 72-73  
     1/2" F1960 Branch, Manifold 70-72  
     1/2" F1960 Valved Branch, Manifold 72  
 PowerPEX® F1960 PEX Kits 68-69  
     F1960 Stub Out Kit 68-69  
     F1960 Water Heater Connector Kit 69  
 PowerPEX® F1960 Preformed Copper & Valves 63-67  
     F1960 Brass Ball Valve 66  
     F1960 Brass Ball Valve 66  
     F1960 Bullet™ 64  
     F1960 Frost-Proof Anti-Siphon Sillcock 67  
     F1960 Sillcock 66  
     F1960 Stub Out Elbow 63  
     F1960 Tub/Shower Pressure Connector 64  
     F1960 Water Heater Connector 64-65

PowerPex® Tools 763-764  
     ASTM F1807/F2159 Tools 763-764  
     ASTM F1960 Tools 764  
     PowerPex® Coil Unwinder 764  
 PowerPEX® Tools 14  
 PowerPEX® Tube 11-14  
     PowerPEX® Tools 14  
     Type A Oxygen Barrier PEX Tube 14  
     Type A PEX Tube 13  
     Type B Oxygen Barrier PEX Tube 12-13  
     Type B PEX Tube 11-12  
 PrimePerfect™ 161  
 Primers 161-163  
 ProCheck™ 447  
 Promenade Drain 282  
 Promenade Drains 282  
 ProPlate™ ¾" Outlet 177  
 ProPlate™ 1/4" Outlet 182  
 ProPlate™ 3/8" Outlet 186  
     Fire-Rated Rough-In Outlet 186  
     Rough-In Outlet 186  
 P-Traps 561-562  
     Repair 562  
     Reversible 561  
     Standard 561  
 P-Traps 573-576  
     Adjustable Sink Trap 575  
     Deep Bell Escutcheon 574  
     Deep Box Escutcheon 574  
     Low-Seal Bath Trap 576  
     Regulation 574-575  
     Repair P-Trap 576  
     Shallow Escutcheon 573  
     Swing Tee 576  
     Utility Traps 575  
 Push Fit Add-A-Line™ 139  
 Push Fit Ball Valve - PDQ™ - Brass 139  
 Push Fit Brass Ball Valve 139  
 Push Fit Cap 135  
 Push Fit Cap - PDQ™ 135  
 Push Fit Coupling 134  
 Push Fit Coupling - PDQ™ 134  
 Push Fit Disconnect Tools 137

Push Fit Elbow 133  
 Push Fit Elbow - PDQ™ 133  
 Push Fit Elbow Adapter 136  
     FIP 136  
     MIP 136  
 Push Fit Elbow Adapter - PDQ™ 136  
     FIP 136  
     MIP 136  
 Push Fit Frost-Proof Sillcock 140  
 Push Fit Sillcock 139  
 Push Fit Sillcock - PDQ™ 139  
 Push Fit Slip Coupling 135  
 Push Fit Slip Coupling - PDQ™ 135  
 Push Fit Straight Adapter 135-136  
     FIP 136  
     FIP Swivel Adapter 136  
     MIP 135  
 Push Fit Straight Adapter - PDQ™ 135-136  
     FIP 136  
     FIP Swivel Adapter 136  
     MIP 135  
 Push Fit Stub Out Elbow 138  
 Push Fit Tee 133  
 Push Fit Tee - PDQ™ 133  
 Push Fit Transition Adapter 134  
 Push Fit Transition Adapter - PDQ™ 134  
 Push Fit Transition Tee 134  
 Push Fit Transition Tee - PDQ™ 134  
 Push Fit Tub/Shower Connector 138  
 Push Fit Water Heater Connector Kit 140  
 Push-Fit Water Heater Connector 138-139  
     FIP Swivel Straight 138  
     Straight Flexible Copper FIP Swivel 139  
 Push-In Closet Flanges 439  
 PushTite™ 439  
 PVC - Fittings, Adapters & Connectors 105-107  
     PVC Brass Ball Valve 107  
     PVC Straight Adapter 105-106  
 PVC - Sch. 40 Hub Connection 345  
 PVC - Sch. 40 Hub Connection 347  
 PVC - Sch. 40 Hub Connection 349  
 PVC - Spanner 371  
 PVC Brass Ball Valve 107

PVC Sch. 40 Hub Connection 452  
 PVC Straight Adapter 105-106  
     F1807 105  
     F1960 105  
     FIP 106  
     Male Sweat 105  
     MIP 106  
     Press-Fitting and Push Fit Compatible 106  
 PVC Tube Cutter 47  
 PVC Tube Cutter - Ratchet 48  
 PVC Vent Cap 457  
 PVC/ABS - Sch. 40 Hub Connection 317-319  
     5-1/2" Tops 318-319  
     6-1/2" Tops 317-318  
 PVC/ABS - Sch. 40 Hub Connection 323  
 PVC/ABS - Sch. 40 Hub Connection 325-327  
     5-1/2" Tops 326-327  
     6-1/2" Tops 325-326  
 PVC/ABS - Sch. 40 Hub Connection 333-334  
     5-1/2" Tops 334  
     6-1/2" Tops 333  
 PVC/ABS - Sch. 40 Hub Connection 356  
 PVC/ABS - Sch. 40 Hub Connection 359  
 PVC/ABS - Sch. 40 Hub Connection 360  
 PVC/ABS - Sch. 40 Hub Connection 364

**Q**

QuadDrain™ 428  
     2x3 PVC/ABS Sch. 40 Hub 428  
     Full-Slip Hub Connection 428  
 Quarter-Turn Bar Stock 609  
 Quarter-Turn Forged Angle Stops 610  
 Quarter-Turn Forged Straight Stops 611  
 Quick Connect 133-141  
 QuickPlug™ 467  
 QuickSpacer™ 442  
 QuickSpacer™ 635

**R**

Raise-A-Ring™ 442  
 Raise-A-Ring™ 635  
 Ratchet Tube Cutter 48  
 Ratcheting Offset Box Wrenches 770  
 Reducing Hex Nipples 700  
 Relief Valve - CPVC 94

Relief Valve - F1807 29  
 Relief Valve - F1960 65  
 Relief Valve - Sweat 122  
 Repair Flange 439  
 Replacelt™ 430  
 Replacement Cleanout Covers 372-373  
     Cast Iron Covers 373  
     Gray ABS Covers 373  
     Nickel Bronze Covers 372  
     Stainless Steel Covers 373  
     Tenz-Alloy Covers 372  
 Replacement Strainers 340  
 Ring - F1960 57  
 Ringer™ 442  
 Ringer™ 635  
 Rings - PEX Crimp 17  
 Rings - PEX Crimp 51  
 Riser 617  
 Riser - Sweat 116-117  
 Riser Stub Out 116-117  
 Roof Drain & Overflow 355  
 Roof Drain Accessories 284  
     Nickel-Bronze Downspout Nozzles 284  
     Stainless Steel Downspout Nozzle Cover 284  
     Vent Cap 284  
 Roof Drains 275-279  
     10" Roof Drain 277  
     10" Weir Roof Drain 278  
     11" Roof Drain 277  
     15" Adjustable Weir Roof Drain 276  
     15" Roof Drain - Alpha Series 275  
     15" Roof Drain - Bravo Series 275-276  
     20" Large-Capacity Roof Drain 278-279  
     8" Roof Drain 278  
 Roof Drains 353-354  
     10" Roof Drain 354  
     11" Roof Drain 353  
 Roof Top Block 540  
 Roof Top Support 540

**S**

SaddleUp™ 535-536  
 SafeFlame™ Protection Pad 775  
 Sand Cloth 780

# Alphabetical Index

Supply

Drainage

Support

Specialties

Appendix

- Save-A-Flange™ 442
- Save-A-Flange™ 636
- SawHorse™ Mini Hacksaws 768
- SawHorse™ Multi-Purpose Saws 768
- Screwdrivers 772
- Screw-On Stainless Steel Strainer 407
- Screw-On Strainers 422
- Scupper Drains 283
- Sealants 783
  - Cement Stop Leak 783
  - Oakum 783
- Sealants, Lubricants, & Tapes 783-784
  - Lubricants 783
  - Sealants 783
  - Tapes 783-784
- Secondary Drainage Funnel 208
- Secure-All™ 517
- Set Screw Connection 365
- Shallow Access 448
  - Backup Float Valve 448
  - DWV Backwater Valve 448
- Shallow-or-Deep Access 447
- Shield Plate 550
- Shower Arm Installation Tool 771
- Shower Arm Test Plug 467
- Shower Arms & Escutcheons 640-641
- Shower Drain Replacement Strainers 422-423
  - Cast Ring & Strainers 422-423
  - Screw-On Strainers 422
  - Snap-In Strainers 422
- Shower Heads 641
- Shower Module Drains 419-420
  - 825 Series - Offset Receptor-Base Style 419
  - 825 Series - Receptor-Base Style 419
  - 826 Series - Outer-Locknut Style 420
  - JackRabbit™ Outer-Locknut Style 420
  - No-Caulk Connection 419
- Shower Pan Drains 407-416
  - Adjustable Slab Shower Drain 414
  - Cast Iron Shower Drains 416
  - Deluxe Matte Stainless Ring & Strainer 410-411
  - Deluxe Nickel-Bronze Ring & Strainer 408-409
  - Deluxe Oil-Rubbed Bronze Finish Ring & Strainer 411
  - Deluxe Polished Stainless Ring & Strainer 409
  - Deluxe Satin Nickel Finish Ring & Strainer 410
  - Grid-Pattern Head & Strainer 412
  - Halo™ Shower Pan Drain 415
  - Large-Capacity Shower Pan Drains 414-415
  - Screw-On Stainless Steel Strainer 407
  - Snap-In Stainless Steel Strainer 407-408
  - Tile-Insert Strainer 413
- Shower Riser 116-117
- Shower Riser Kits - Sweat 129
- Shower WallNut™ 640
- Shower WallNut™ Removal Tool 773
- ShowerUp™; Kits - CPVC 97
- Shower-Up™; Kits - Sweat 129
- Shutoff Cocks 753
- SideWinder™ 521
- Sillcock 123
- Sillcock - CPVC 96
- Sillcock - F1807 31
- Sillcock - F1960 66
- Sillcock - Frost-Proof - CPVC 96
- Sillcock - Frost-Proof - F1807 31
- Sillcock - Frost-Proof - F1960 67
- Sillcock - Frost-Proof - Sweat/MIP 123-124
- Sillcock - Frost-Proof Replacement Parts 124
- Sillcock - PDQ™ Push Fit 139
- Simple Bend Support 521
- SimpleStrap™ 529
- Single Hole Tube Strap 486
- Sink Tailpiece/Extension 565
- Sink Tailpieces 565
- Sink Tailpieces 579-580
- Sink/Faucet Repair 624-625
  - Faucet Aerators 624
  - Faucet Hole Covers 625
  - Kitchen Hose Spray 625
  - NoPutty™ Gaskets 625
  - O-Rings 624
- Sioux Chief Sammys - Thread Rod Anchors 495
- Sioux Chief Sammys - Thread Rod Anchors 546
- SiouxStrap™ 480
- Site-Adjustable Linear Shower Drain 418
- Slab Manifold - ½" F1807 Branches 43-44
- 3/4" F1807 × 3/4" F1807 Trunk 44
- 3/4" F1807 × Closed Trunk 43
- Slab Manifold - ½" F1960 Branches 72-73
- 3/4" F1960 PEX x 3/4" F1960 PEX Trunk 73
- 3/4" F1960 PEX x Closed Trunk 72
- Slab Manifold - Poly - ½" F1960 Branches 77
- Sleeve - F1960 57
- Slider™ 529
- Slip-Joint Pliers 770
- SmartCap™ 631
- SmartSaddle™ 457
- Snap-In Stainless Steel Strainer 407-408
- Snap-In Strainers 422
- Solder Straps 518
- Spacer & Repair Rings 442-443
  - Closet Flange Floor Support 443
  - QuickSpacer™ 442
  - Raise-A-Ring™ 442
  - Ringer™ 442
  - Save-A-Flange™ 442
  - Two-Piece Repair Ring 442
- Specialty Flanges 441
  - Brass Closet Flange Rings 441
  - Cast Iron Closet Flanges 441
  - Urinal Flange Kit 441
- Split Ring Hanger 544-545
- Splitter 161
  - Distributor 161
  - Wye Splitter 161
- Square Access Panels 300
- SquareMax™ Floor Sink Accessories 346
- SquareMax™ PVC Square Floor Sink 345-346
  - PVC - Sch. 40 Hub Connection 345
  - SquareMax™ Floor Sink Accessories 346
- St. Louis Style Floor Drain 431
- Stainless Steel 257
- Stainless Steel - No-Hub Connection 241
- Stainless Steel - No-Hub Connection 289-290
- Stainless Steel Bands 496
- Stainless Steel Downspout Nozzle Cover 284
- Stainless Steel Floor Sink 271
- Stainless Steel Hose Clamps 747
- Stainless Steel Linear Shower Drain 417

- Stainless Steel Tube Stiffener 137
- StainlessStar™ 496
- StickEm Up™ 502
- Stop & Waste Valve 123
- Stop Valve 609-613
- Straight Adapter 25
  - Compression 25
  - Polybutylene (PB) (ASTM F1380) × PEX 25
- Straight Adapter - PDQ™ Push Fit 135-136
  - FIP 136
  - FIP Swivel Adapter 136
  - MIP 135
- Straight Adapter - Sch 40 CPVC 101-102
  - F1807 101
  - F1960 101
  - FIP 102
  - Male Sweat 101
  - MIP 101
- Strainers for Bell Trap Drain 432
- Strainers for City-Style Drains 432-433
- Strainers for Weld One / Quad Drain 432
- Strap Wrench 770
- S-Traps 562
- S-Traps 577
- StreamLine™ Linear Shower Pan Drains 417-418
  - Low-Profile Linear Shower Drain 418
  - Site-Adjustable Linear Shower Drain 418
  - Stainless Steel Linear Shower Drain 417
- StrongArm™ 515-516
  - LockBlock™ or PEX Bend LockBlock™ 515-516
  - Shower WallNut™ LockBlock™ 516
  - Vent Support 516
- Strut Clamps 545
- Stub Out - F1807 27
- Stub Out - F1960 64
- Stub Out - F3347 81
- Stub Out - Sweat 115-116
  - Male Sweat 115
  - MIP 116
- Stub Out Bracket 517
- Stub Out Bracket with Stud Guard 518
- Stub Out Brackets 515-518
  - Edge™ Support System 517
- Secure-All™ 517
- Solder Straps 518
- StrongArm™ 515-516
- Stub Out Bracket 517
- Stub Out Bracket with Stud Guard 518
- Stub Out Elbow - CPVC 93
  - Square O Strap 93
  - Standard 93
- Stub Out Elbow - F1807 26-27
  - Double Stub Out 27
  - Square O Strap 26
- Stub Out Elbow - F1960 63
  - Double Stub Out 63
  - Square O Strap 63
- Stub Out Elbow - F3347 81
- Stub Out Elbow - PDQ™ Push Fit 138
- Stub Out Elbow - Sweat 113-114
  - Double Stub Out 114
  - Male Sweat Offset 114
  - Square O Strap 114
- Stub Out Elbows - Sch 40 CPVC 102
- Stub Out Kits - CPVC 97-98
  - 1/2" Lav/Sink Stub Outs With Bracket 97
  - 1/2" Shower Riser Elbow With Bracket 98
  - 1/2" Water Closet Stub Out With Bracket 97
  - 3/4" Water Heater Stub Outs With Bracket 98
- Stub Out Kits - F1807 33-34
  - 1/2" Lav/Sink Stub Outs With Bracket 33
  - 1/2" Shower Riser Elbow With Bracket 34
  - 1/2" Water Closet Stub Out With Bracket 33
  - 3/4" Water Heater Stub Outs With Bracket 34
- Stub Out Kits - F1960 68-69
  - 1/2" Lav/Sink Stub Outs With Bracket 68
  - 1/2" Shower Riser Elbow With Bracket 69
  - 1/2" Water Closet Stub Out With Bracket 68
  - 3/4" Water Heater Stub Outs With Bracket 69
- Stub Out Kits - F3347 83
  - 1/2" Lav/Sink Stub Outs With Bracket 83
  - 1/2" Water Closet Stub Out With Bracket 83
- Stud Guard 549
  - Metal Studs 549
  - Self-Nailing 549
- Stud Guards & Safety Plates 549-550
- Shield Plate 550
- Stud Guard 549
- Stud Shoe 549
- Stud Shoe 549
- Suction/Discharge Hose 658
- Supply Stops & Kits 609-613
  - Add-A-Valve Fitting 613
  - Multi-Turn Angle Stops 612
  - Multi-Turn Straight Stops 613
  - Quarter-Turn Bar Stock 609
  - Quarter-Turn Forged Angle Stops 610
  - Quarter-Turn Forged Straight Stops 611
- Supply Tubes 617-618
  - Dishwasher Supply & Kits 618
  - Ice Maker Supply & Kits 618
  - Lav/Sink Supply 617
  - Toilet Supply 617
  - Washers & Gaskets 618
- Support Bracket 530
- Suspension Clamp 482-483
- Suspensulator™ 483
- Sweat - Fittings, Adapters & Connectors 111-112
  - Elbow Adapter 112
  - Full Slip Male Adapter 111
  - Sweat Dielectric Union 112
  - Sweat Elbow Adapter 111
  - Wal-Let™ 111
- Sweat Brass Ball Valve 122
- Sweat Bullet™ 115-116
  - Male Sweat 115
  - MIP 116
- Sweat Coupling 113
- Sweat Dielectric Union 112
- Sweat Elbow Adapter 111
- Sweat Kits 129
  - Sweat Shower-Up™ Kit 129
  - Sweat Water Heater Connector Kit 129
- Sweat Manifolds 126-128
  - 1/2" Male Sweat Branch, Manifold 126
  - 1/2" MIP Branch, Manifold 127-128
  - 1/2" MIP/FSWT Ball Valve Branch, Manifold 128
  - 3/4" Female Sweat Branch, Manifold 127
  - 3/4" Male Sweat Branch, Manifold 126-127

Sweat Preformed Copper & Valves 113-125  
 Add-A-Line™ 121  
 Brass Boiler Drain 123  
 Brass Stop & Waste Valve 123  
 Cross Adapters 120  
 Frost-Proof Anti-Siphon Sillcock 123-124  
 Frost-Proof Sillcock Replacement Parts 124  
 Heat Trap Loop 121  
 Riser Stub Out 116-117  
 Sillcock 123  
 Sweat Brass Ball Valve 122  
 Sweat Bullet™ 115-116  
 Sweat Coupling 113  
 Sweat Stub Out Elbow 113-114  
 Sweat Tub Spout Elbow 114-115  
 Sweat Tub/Shower Pressure Connector 116  
 Termination Fitting 113  
 Thermostatic Mixing Valve 125  
 Vacuum Breaker 125  
 Water Heater Connector 117-120  
 Water Heater Stub Out Loop 121  
 Water Meter Adapters 122  
 Water Service Connectors 121  
 Water Softener Connector 120  
 Sweat Shower-Up™ Kit 129  
 Sweat Stub Out 115-116  
 Male Sweat 115  
 MIP 116  
 Sweat Stub Out Elbow 113-114  
 Double Stub Out 114  
 Male Sweat Offset 114  
 Square O Strap 114  
 Sweat Tub Spout Elbow 114-115  
 Sweat Tub/Shower Pressure Connector 116  
 Sweat Water Heater Connector Kit 129  
 Sweat/MIP Adapter 111  
 Swivel J-Hanger™ 501

## T

Tank Handles 635  
 Tank-To-Bowl Repair 633  
 Tape Measure 774  
 Tapes 783-784  
 Duct Tape 783

Pipe Thread Tape 784  
 T-Cone™ 463  
 TD+™ 485  
 TD+™ Plenum-Rated Universal Clamps 537  
 TD+™ Universal Clamps 536  
 Tee - Add-A-Line™ 121  
 Tee - Add-A-Line™ - PDQ™ Push Fit 139  
 Tee - F1807 18-19  
 Tee - F1960 57-58  
 Tee - F1960 Poly 74-75  
 Tee - F2159 52  
 Tee - Ice Maker Valve - F1807 32  
 Tee - PDQ™ Push Fit 133  
 Tee - Transition - PDQ™ Push Fit 134  
 TeePee™ 464  
 Telescoping Basin Wrench 770  
 Termination Fitting 113  
 Test Devices 463-467  
 Dual-Fit Test Caps 466  
 Flexible PVC Test Caps 466  
 GripTip™ 465  
 GripTip™ 467  
 HandTite™ 464  
 HardHat™ 466  
 Inflatable Cleanout Tee Plug 464  
 Inflatable Test Plug 465  
 Knockout Test Plugs 466  
 QuickPlug™ 467  
 Shower Arm Test Plug 467  
 T-Cone™ 463  
 TeePee™ 464  
 TestTitan™ 463  
 Test Gauge Assemblies 471  
 Test Gauges 471  
 Testable Closet Flange 437  
 TestTitan™ 463  
 Thermostatic Mixing Valve 125  
 Thread Bulkhead Union Adapters 711  
 Threaded Tube 585  
 Through-Floor Protective Sleeve 521  
 Tie-Down Straps 775  
 Tile-Insert Strainer 413  
 TKO™ 437

TMV 125  
 Toilet Bolts 631  
 Toilet Supply 617  
 Toilet Tank Fill Valves 634  
 Anti-Siphon 634  
 Governor™ 634  
 Toilet Tank Flush Valves 634  
 Toilet/Dishwasher Box - 3/8" Comp. Outlet 185-186  
 OxBox™ 3/8" Outlet, Fire-Rated - Single Valve 185-186  
 OxBox™ 3/8" Outlet-Single valve 185  
 ProPlate™ 3/8" Outlet 186  
 Tomahawk™ 509  
 Tools & Accessories 767-775  
 Access Grommet Removal Tool 772  
 Allen Wrench Set 770  
 Bin Boxes 775  
 Copper Tube Cutters 767  
 Deburring Tool 769  
 Faucet Handle Puller 773  
 Faucet Seat Wrenches 771  
 Faucet Stem Key 771  
 Flaring Tool 773  
 Flexible Grabber 773  
 Inside Pipe Cutter 769  
 Inspection Mirror 774  
 Levels 774  
 Match Holder 774  
 Metal Stud Punch 769  
 Moen Cartridge Puller 773  
 O-Ring Pick 773  
 PDQ™ Push-Fit Disconnect Tools 772  
 Peg-Board Hook 775  
 Plunger 774  
 PO Plug Wrench 771  
 Poly Tube Cutters 767  
 Ratcheting Offset Box Wrenches 770  
 SafeFlame™ Protection Pad 775  
 SawHorse™ Mini Hacksaws 768  
 SawHorse™ Multi-Purpose Saws 768  
 Screwdrivers 772  
 Shower Arm Installation Tool 771  
 Shower WallNut™ Removal Tool 773  
 Slip-Joint Pliers 770



Strap Wrench 770  
 Tape Measure 774  
 Telescoping Basin Wrench 770  
 Tie-Down Straps 775  
 Tub/Shower Socket Set 771  
 Utility Knife 767  
 Water Heater Element Wrench 772  
 Wire Cable Saw 768  
 Work Gloves 775  
 Totem™ 481  
 TouchDown™ 485  
 Transition Adapter - PDQ™ Push Fit 134  
 Transition Tee - PDQ™ Push Fit 134  
 Trap Accessories 562  
 Trap Accessories 577-578  
 Trap Primer Adapter 162  
 Trap Primers 161-163  
     Electronic Trap Primer 162-163  
     PrimePerfect™ 161  
     Splitter 161  
     Trap Primer Adapter 162  
     Trap-Ease™ 162  
     TrapShield™ 163  
 Trap-Ease™ 162  
 TrapShield™ 163  
 TrapShield™ 260  
 TrapShield™ 340  
 Trench Drains 379-398  
 Tub Spout Elbow - Sweat 114-115  
 Tub Spouts 639  
     SmartSpout™ 639  
     Standard 639  
 Tub/Shower Pressure Connector - CPVC 93  
 Tub/Shower Pressure Connector - F1807 28  
 Tub/Shower Pressure Connector - F1960 64  
 Tub/Shower Pressure Connector - F3347 81  
 Tub/Shower Pressure Connector - Sweat 116  
 Tub/Shower Socket Set 771  
 Tub/Shower Specialties 639-641  
     Add-A-Shower 641  
     DrySeal™ Pipe Collar 640  
     Shower Arms & Escutcheons 640-641  
     Shower Heads 641

Shower WallNut™ 640  
 Tub Spouts 639  
 Tube Clamp 482  
 Tube Cutter - Plastic 47  
 Tube Cutter - Ratchet 48  
 Tube Insulator 483-484  
 Tube OD Brush 780  
 Tube Stiffener 46  
 TubeTalon™ 479  
 Tubing - PEX 11-14  
 Tubing - Vinyl 647-649  
 Tubular Fittings 568  
 Tubular Fittings 586  
 TurboVent™ 451-453  
     ABS Sch. 40 Hub Connection 453  
     Accessories 453  
     MIP Thread Connection 451  
     PVC Sch. 40 Hub Connection 452  
 TwinTalon™ 480  
 Two-Piece Repair Ring 442  
 Two-Piece Repair Ring 635  
 Type A Oxygen Barrier PEX Tube 14  
 Type A PEX Tube 13  
     Coils 13  
     Sticks 13  
 Type B Oxygen Barrier PEX Tube 12-13  
     Coils 12-13  
     Sticks 12  
 Type B PEX Tube 11-12  
     Coils 11-12  
     Sticks 11

**U**

Universal Brackets 525-526  
 Urinal Carriers 310  
 Urinal Flange Kit 441  
 Utility Knife 767

**V**

VacuRester™ 157  
 Vacuum Breaker 125  
 Valve - Add-A-Line™ 121  
 Valve - CPVC - Brass 96  
 Valve - F1807 - Brass 30-31  
 Valve - F1960 - Brass 66

Valve - F3347 - Brass 82  
 Valve - Ice Maker - F1807 32  
 Valve - PDQ™ Push Fit - Brass 139  
 Valve - PVC - Brass 107  
 Valve - Sweat - Brass 122  
 Valves 207  
 Valves & Cocks 751-753  
     Cooler Fittings 752  
     Drain Cocks 752  
     Needle Valves - Angled 751  
     Needle Valves - Saddle Valves 752  
     Needle Valves - Straight 751  
     Shutoff Cocks 753  
 Vandal-Resistant Strainer Screws 342  
 Vent Cap 284  
 Vertical 306-307  
     Bariatric (1,000 Lb) 307  
     Extra-Heavy (750 Lb) 307  
     Standard (500 Lb) 306  
 Vinyl Tubing 647-649  
     Black Vinyl Tubing 649  
     Clear Vinyl Tubing 647-649  
 Vinyl-coated Steel Clamp with Screw 490  
 V-Sleeve™ 17  
 V-Sleeve™ 51  
 V-Sleeve™ Compression Tool 47

**W**

Wall Cleanouts 300  
     Cleanout Cover Kits 300  
     Cleanout Covers 300  
     Square Access Panels 300  
 Wall Cleanouts 366-368  
     Cleanout Cover Accessories 367-368  
     Cleanout Cover Kits 367  
     Cleanout Covers 366  
 Wall Termination Fitting - CPVC 92  
 Wall Termination Fitting - Sweat 111  
 Wal-Let™ 111  
 Wal-Let™ - CPVC 92  
 Wal-Let™ - F1960 62  
 Washers & Gaskets 618  
 Washing Machine Box 169-173  
 Waste Arms 567

# Alphabetical Index

Supply

Drainage

Support

Specialties

Appendix

- Waste Arms 584-585
  - Straight Basin 584
  - Waste Bend 584-585
- Water Cooler Carriers 311
- Water Hammer Arresters - HydraRester™ 155-156
  - CPVC 156
  - MIP 155
  - PEX 156
  - Sweat/Press-Fit 155
- Water Hammer Arresters - MegaRester™ 156-157
  - Copper 156
  - Stainless Steel 157
- Water Hammer Arresters - MiniRester™ 153-155
  - Compression Tee 154
  - Female Compression Tee 155
  - Laundry Hose Tee/Toilet Fill Valve Tee 153
  - PEX Tee 154
  - Straight 153
  - Tub Shower / Stub Out Tee 153-154
- Water Hammer Arresters 153-157
  - HydraRester™ 155-156
  - MegaRester™ 156-157
  - MiniRester™ 153-155
  - VacuRester™ 157
- Water Heater Accessories 553
  - Expansion Tank Support Kits 553
  - Water Heater Stand 553
- Water Heater Connector 117-120
  - Corrugated Flexible SS Connectors 120
  - Female Sweat × FIP Elbow 117
  - FIP Swivel × Full-Slip Female Sweat 118
  - FIP Swivel × Male Sweat 118
  - FIP Swivel Elbow 117
  - FIP Swivel With Expansion Tank Branch 119
  - Flexible Copper Water Heater Connector 118-119
  - Valved With Expansion Tank Branch, Full Port 119
- Water Heater Connector - CPVC 94-95
  - FIP Swivel Elbow 94
  - FIP Swivel Straight 94
  - Flexible Copper FIP Swivel 95
  - MIP Straight 95
  - Straight FIP Swivel With Expansion Tank Branch 95
  - T&P Relief Adapter 95
- Water Heater Connector - F1807 28-30
  - FIP Swivel Elbow 28
  - FIP Swivel Straight 29
  - FIP Swivel With FIP Tee 30
  - FIP Swivel With MIP Branch 30
  - Flexible Copper, FIP Swivel 29
- Water Heater Connector - F1960 64-65
  - FIP Swivel Elbow 64
  - FIP Swivel Straight 65
  - Flexible Copper FIP Swivel 65
- Water Heater Connector - F3347 82
- Water Heater Connector Kit - CPVC 98
- Water Heater Connector Kit - F1807 34
- Water Heater Connector Kit - F1960 69
- Water Heater Connector Kits - Sweat 129
- Water Heater Element Wrench 772
- Water Heater Loops 30
- Water Heater Stand 553
- Water Heater Stub Out Loop 121
- Water Meter Adapters 122
- Water Service Connectors 121
- Water Softener Connector 120
- Wedgelt™ 632
- WeldOne™ 427
- WiderSlider™ 529
- Wire Cable Saw 768
- Wire Pipe Hook 490
- Wobble Wedges 632
- Work Gloves 775

## Y

- Y Splitter 161
  - Distributor 161
  - Wye Splitter 161

## Z

- Zip Ties 496
- ZipStick™ 502

Item No	Page No	Min Qty	Case Qty	UPC Bar-Coded	UPC 6-Digit	Weight (lbs.)	Item No	Page No	Min Qty	Case Qty	UPC Bar-Coded	UPC 6-Digit	Weight (lbs.)
104-G22	122	<b>8</b>	8	No	415080	0.394	<b>119-01</b>	124	1	10	No	566652	0.0957
104-G23	122	<b>8</b>	8	No	415073	0.644	<b>119-03</b>	124	1	10	No	566218	0.0699
104-G24	122	<b>5</b>	40	No	410801	1.032	<b>119-04</b>	124	1	25	No	566225	0.0087
105-G22	122	<b>7</b>	70	No	410795	0.424	<b>119-07</b>	124	1	100	No	566232	0.1354
105-G23	122	<b>5</b>	40	No	410788	0.682	<b>119-08</b>	124	1	6	No	566249	0.0888
105-G24	122	<b>3</b>	15	No	410771	1.0935	<b>119-08C</b>	124	1	6	No	566256	0.0851
111-G22	123	<b>10</b>	100	No	203502	0.51	<b>119-0904</b>	124	1	10	No	566263	0.0844
111-G23	123	<b>10</b>	100	No	203526	0.78	<b>119-0906</b>	124	1	10	No	566270	0.1043
113-32	123	<b>10</b>	100	Yes	500144	0.523	<b>119-0908</b>	124	1	10	No	566287	0.1257
113-33	123	<b>10</b>	100	Yes	500151	0.552	<b>119-0910</b>	124	1	10	No	566294	0.1426
117-03	125	<b>20</b>	240	Yes	500182	0.2423	<b>119-0912</b>	124	1	10	No	566300	0.1693
117-12	123	<b>10</b>	100	No	200655	0.68	<b>119-10</b>	124	1	6	Yes	566317	0.0877
117-C22	96	<b>25</b>	25	No	400055	0.6455	<b>119-204</b>	124	1	25	No	518811	1.5395
117-C223E	96	<b>25</b>	25	No	400277	0.6831	<b>119-206</b>	124	1	25	No	518828	1.5454
117Q22	139	<b>6</b>	6	Yes	408310	0.7917	<b>119-208</b>	124	1	25	No	518835	1.72
117S2	123	<b>10</b>	100	Yes	711472	-	<b>119-210</b>	124	1	25	No	518842	1.744
117W2	66	<b>10</b>	100	Yes	711489	-	<b>119-210CPK</b>	124	5	5	Yes	518859	2.0337
117X2	31	<b>10</b>	100	Yes	711496	0.497	<b>119-212</b>	124	1	25	No	518873	1.8096
118-01	124	12	12	No	500007	0.077	<b>119-C208</b>	96	<b>5</b>	5	No	406163	1.55
118-02	124	12	12	No	500212	0.0072	<b>119-C210</b>	96	<b>5</b>	5	No	406170	1.6524
118-03	124	1	1	No	500229	0.013	<b>119Q208</b>	140	<b>5</b>	5	No	421838	1.53
118-04	124	12	12	No	500236	0.006	<b>119Q210</b>	140	<b>5</b>	5	No	421821	1.62
118-05	124	12	12	No	506672	0.001	<b>119X204P</b>	31	<b>2</b>	2	No	518880	1.432
118-06	124	1	1	No	500342	0.002	<b>119X206P</b>	31	<b>5</b>	5	No	518897	1.4828
118-07	124	1	1	No	500441	0.014	<b>119X208P</b>	31	<b>5</b>	5	No	518903	1.535
118-08	124	1	1	No	500274	0.027	<b>119X210P</b>	31	<b>5</b>	5	No	518910	1.65
118-0904	124	1	1	No	500281	0.116	<b>119X212P</b>	31	<b>5</b>	5	No	518927	1.678
118-0906	124	1	1	No	500298	0.14	<b>120-TM3F</b>	125	<b>1</b>	10	Yes	733962	-
118-0908	124	1	1	No	500304	0.158	<b>120-TM3F-1</b>	125	<b>1</b>	500	Yes	735775	-
118-0910	124	1	1	No	500311	0.176	<b>120-TM3F-1</b>	190	<b>1</b>	500	Yes	735775	-
118-0912	124	1	1	No	500328	0.305	<b>120-TM3F-2</b>	125	<b>1</b>	300	Yes	735744	-
118-C208	96	<b>5</b>	5	No	400390	1.3841	<b>120-TM3F-2</b>	190	<b>1</b>	300	Yes	735744	-
118-C210	96	<b>5</b>	5	No	406156	1.4915	<b>120-TM3F-3</b>	125	<b>1</b>	500	Yes	735768	-
118M204	123	<b>1</b>	40	Yes	401779	1.37	<b>120-TM3F-3</b>	190	<b>1</b>	500	Yes	735768	-
118M206	123	<b>1</b>	40	Yes	401830	1.2525	<b>129-G1C1C</b>	609	24	144	Yes	502391	0.2465
118M208	123	<b>1</b>	40	Yes	401885	1.3475	<b>129-G1F1C</b>	609	24	144	Yes	502360	0.2778
118M210	123	<b>1</b>	40	Yes	402004	1.415	<b>129-G1RETRO</b>	609	24	144	Yes	502353	0.2597
118M212	123	<b>1</b>	40	Yes	402028	1.6562	<b>129-G2C0C</b>	609	24	144	Yes	502346	0.3031
118W204	67	<b>1</b>	40	Yes	402202	1.1425	<b>129-G2C1C</b>	609	24	144	Yes	502339	0.2958
118W206	67	<b>1</b>	40	Yes	402226	1.2225	<b>129-G2F1C</b>	609	24	144	Yes	502322	0.284
118W208	67	<b>1</b>	40	Yes	402301	1.3162	<b>129-G2S1C</b>	609	24	144	Yes	502315	0.2399
118W210	67	<b>1</b>	40	Yes	402325	1.4038	<b>129-G2V1C</b>	609	24	144	Yes	502308	0.2917
118W212	67	<b>1</b>	40	Yes	402349	1.4975	<b>129-G2W0C</b>	609	24	144	Yes	502292	0.2361
118X204	31	<b>1</b>	40	Yes	402080	1.1338	<b>129-G2W1C</b>	609	24	144	Yes	204844	0.2134
118X204P	31	<b>5</b>	5	No	510082	1.2019	<b>129-G2X0C</b>	609	24	144	Yes	502285	0.2309
118X206	31	<b>1</b>	40	Yes	402103	1.2288	<b>129-G2X1C</b>	609	24	144	Yes	502278	0.2292
118X208	31	<b>1</b>	40	Yes	402141	1.3062	<b>130-G1F1C</b>	609	24	144	Yes	502261	0.292
118X210	31	<b>1</b>	40	Yes	402165	1.4025	<b>130-G2C0C</b>	609	24	144	Yes	502254	0.3083
118X212	31	<b>1</b>	40	Yes	402189	1.505	<b>130-G2C1C</b>	609	24	144	Yes	502223	0.2997
119-00	124	1	25	No	566195	0.0144	<b>130-G2F1C</b>	609	24	144	Yes	502216	0.309

Supply

Drainage

Support

Specialties

Appendix

# Numerical Index

Supply

Drainage

Support

Specialties

Appendix

Item No	Page No	Min Qty	Case Qty	UPC Bar-Coded	UPC 6-Digit	Weight (lbs.)	Item No	Page No	Min Qty	Case Qty	UPC Bar-Coded	UPC 6-Digit	Weight (lbs.)
130-G2S1C	609	24	144	Yes	502209	0.2431	133-G2V1C04	613	1	50	Yes	451088	0.321
130-G2V1C	609	24	144	Yes	502193	0.292	133-G2V1CR104	613	1	50	Yes	451095	0.339
130-G2W0C	609	24	144	Yes	502186	0.2583	133-G2X1C04	613	1	50	Yes	451101	0.229
130-G2W1C	609	24	144	Yes	204851	0.2321	133-GZ2M2FR104	613	1	20	Yes	502735	0.36
130-G2X0C	609	24	144	Yes	502179	0.2434	133-GZ2S2SR104	613	1	50	Yes	451118	0.25
130-G2X1C	609	<b>24</b>	144	Yes	502162	0.2372	134-G1F1C04	612	1	50	Yes	448996	0.191
131-G0Y3HR101	611	<b>5</b>	60	Yes	722331	-	134-G2C0C04	612	1	50	Yes	451156	0.237
131-G1F1C04	611	<b>20</b>	240	Yes	450722	0.21	134-G2C0CR104	612	1	50	Yes	451163	0.25
131-G1Q1C04	611	<b>1</b>	32	Yes	450739	0.3109	134-G2C1C04	612	1	50	Yes	451170	0.243
131-G2C1C04	611	<b>20</b>	240	Yes	450746	0.2673	134-G2C1C0CDHR104	612	1	50	Yes	450852	0.651
131-G2C1C09	611	<b>1</b>	50	Yes	449313	0.27	134-G2C1C1C04	612	1	30	Yes	207135	-
131-G2F1C04	611	<b>20</b>	240	Yes	450760	0.2385	134-G2C1C1CDH04	612	1	50	Yes	450876	0.604
131-G2Q1C04	611	<b>1</b>	32	Yes	502711	0.2391	134-G2C1C1CDHR104	612	1	50	Yes	450883	0.651
131-G2S1C04	611	<b>20</b>	240	Yes	450777	0.2298	134-G2C1C1CR104	612	1	30	Yes	450890	0.295
131-G2S1CE504	611	<b>10</b>	120	Yes	450784	0.3754	134-G2C1CE504	612	1	50	Yes	461421	0.255
131-G2V1C04	611	<b>20</b>	120	Yes	450791	0.2825	134-G2C1CLK04	612	1	50	Yes	451187	0.373
131-G2X1C04	611	<b>1</b>	30	Yes	502728	0.2073	134-G2C1CR104	612	1	50	Yes	451194	0.262
131-G2X2M01	611	<b>5</b>	30	Yes	449023	0.225	134-G2C2C04	612	1	50	Yes	451200	0.265
131-G2X2X04	611	<b>20</b>	240	Yes	450807	0.1869	134-G2C2M04	612	1	50	Yes	451217	0.29
131-GRETR001	611	<b>5</b>	30	Yes	449214	0.305	134-G2F1C04	612	1	50	Yes	451224	0.241
132-G1F1C04	610	<b>20</b>	240	Yes	450814	0.235	134-G2F1C1C04	612	1	30	Yes	461445	0.26
132-G1Q1C04	610	<b>1</b>	32	Yes	450821	0.2359	134-G2F1C1CR104	612	1	30	Yes	450968	0.2833
132-G2C0C04	610	<b>20</b>	240	Yes	450838	0.2804	134-G2F1CLK04	612	1	50	Yes	451231	0.361
132-G2C1C04	610	<b>20</b>	240	Yes	450845	0.2906	134-G2F2C04	612	1	50	Yes	451286	0.255
132-G2C1C09	610	<b>10</b>	50	Yes	449177	0.296	134-G2F2CLK04	612	1	50	Yes	451293	0.373
132-G2C1C0C01	610	<b>5</b>	30	Yes	449160	0.3267	134-G2F2M04	612	1	50	Yes	451309	0.273
132-G2C1C1C04	610	<b>20</b>	240	Yes	450869	0.3265	134-G2S0CR104	612	1	50	Yes	451316	0.259
132-G2C1CLH04	610	<b>20</b>	240	Yes	450906	0.3579	134-G2S1C04	612	1	50	Yes	451323	0.25
132-G2C1CN104	610	<b>20</b>	240	Yes	450913	0.266	134-G2S1CE504	612	1	50	Yes	451330	0.389
132-G2C2C04	610	<b>20</b>	240	Yes	450944	0.3035	134-G2S1CE5LK04	612	1	50	Yes	451347	0.45
132-G2C2M01	610	<b>1</b>	30	Yes	449146	0.33	134-G2S1CLR04	612	1	50	Yes	451354	0.311
132-G2FOC01	610	<b>1</b>	30	Yes	449139	0.2667	134-G2S1CR104	612	1	50	Yes	451361	0.254
132-G2F1C04	610	<b>20</b>	240	Yes	437853	0.2744	134-G2V1C04	612	1	50	Yes	451378	0.27
132-G2F1C0C01	610	<b>5</b>	30	Yes	449115	0.3183	134-G2V1CR104	612	1	50	Yes	451385	0.289
132-G2F1C1C04	610	<b>20</b>	240	Yes	450951	0.3	134-G2X1C04	612	1	50	Yes	451392	0.176
132-G2F2C04	610	<b>20</b>	240	Yes	449092	0.2971	200-062	582	25	25	No	500472	0.358
132-G2F2M01	610	<b>5</b>	30	Yes	449085	0.315	200-064	582	25	25	No	500489	0.408
132-G2Q1C04	610	<b>1</b>	32	Yes	700155	0.29	200-066	582	25	25	No	500496	0.408
132-G2S1C04	610	<b>20</b>	240	Yes	450975	0.2383	200-082	582	25	25	No	500502	0.4301
132-G2S1CE504	610	<b>10</b>	120	Yes	450999	0.3846	200-084	582	25	25	No	500519	0.4801
132-G2V1C04	610	<b>20</b>	120	Yes	451002	0.3004	200-090	162	25	25	No	105004	0.4801
132-G2X1C04	610	<b>5</b>	30	Yes	449030	0.2	200-092	162	25	25	No	105011	0.4801
133-G1F1C04	613	<b>1</b>	50	Yes	451026	0.252	200-122	582	25	25	No	500540	0.5573
133-G2C1C04	613	<b>1</b>	50	Yes	451033	0.294	200-12225	583	<b>25</b>	25	No	502896	0.61
133-G2C1C1CDHR104	613	<b>1</b>	50	Yes	450753	0.657	200-124	582	25	25	No	518965	0.6073
133-G2C1CR104	613	<b>1</b>	50	Yes	451040	0.313	206-064	582	25	25	No	500397	0.474
133-G2F1C04	613	<b>1</b>	50	Yes	451057	0.291	206-066	582	25	25	No	500588	0.464
133-G2S1C04	613	<b>1</b>	50	Yes	451064	0.313	206-084	582	25	25	No	500595	0.6946
133-G2S1CE504	613	<b>1</b>	50	Yes	449009	0.444	206-096	162	25	25	No	415240	0.3853
133-G2S1CR104	613	<b>1</b>	50	Yes	451071	0.305	207-06325	583	<b>25</b>	25	No	451408	0.344

Item No	Page No	Min Qty	Case Qty	UPC Bar-Coded	UPC 6-Digit	Weight (lbs.)	Item No	Page No	Min Qty	Case Qty	UPC Bar-Coded	UPC 6-Digit	Weight (lbs.)
207-08325	583	<b>25</b>	25	Yes	451415	0.358	230-1106101	562	<b>10</b>	10	Yes	448880	0.64
207-08425	583	<b>25</b>	25	Yes	714176	-	230-1106201	562	<b>10</b>	10	Yes	701220	0.78
207-12225	583	<b>25</b>	25	No	451422	0.466	230-1106301	562	<b>10</b>	10	Yes	701237	0.82
207-12425	583	<b>25</b>	25	No	451439	0.822	230-1116101	562	<b>10</b>	10	Yes	701244	-
210-064	582	25	25	No	500601	0.3841	230-1505101	562	<b>12</b>	12	Yes	448873	0.1625
210-066	582	25	25	No	500618	0.372	230-1506101	562	<b>25</b>	25	Yes	448866	0.188
210-084	582	25	25	No	500625	0.4563	230-1516101	562	<b>25</b>	25	Yes	701251	0.194
210-086	582	25	25	No	500632	0.454	230-1606101	562	<b>12</b>	12	Yes	448859	0.2292
210-122	582	25	25	No	500649	0.55	230-1616101	562	<b>12</b>	12	Yes	701268	0.2167
210-12225	583	<b>1</b>	25	No	502902	0.59	230-170507101	562	<b>25</b>	25	Yes	701275	-
210-28625	583	<b>25</b>	25	No	451446	0.416	230-170607101	562	<b>25</b>	25	Yes	448842	0.14
210-38625	583	<b>25</b>	25	No	451453	0.472	230-170616101	563	<b>25</b>	25	Yes	701282	-
213-060	583	25	25	No	504838	0.3166	230-170616201	563	<b>25</b>	25	Yes	701299	-
213-061	583	25	25	No	509550	0.324	230-171616101	563	<b>25</b>	25	Yes	701305	-
213-067	584	25	25	No	500670	0.3378	230-180616101	563	<b>25</b>	25	Yes	701312	0.534
213-068	583	25	25	No	509574	0.3166	230-180616201	563	<b>25</b>	25	Yes	701329	0.5031
213-069	584	25	25	No	509567	0.2911	230-181616101	563	<b>25</b>	25	Yes	701336	0.514
213-090	162	25	25	No	105028	0.3483	230-190616101	563	<b>25</b>	25	Yes	701343	-
213-092	162	25	25	No	105035	0.3483	230-190616201	563	<b>25</b>	25	Yes	701350	0.54
215-064	583	25	25	No	500700	0.3503	230-191616101	563	<b>25</b>	25	Yes	701367	-
215-066	583	25	25	No	500717	0.3503	230-200616101	563	<b>25</b>	25	Yes	451569	0.46
216-084	582	25	25	No	500724	0.428	230-200616201	563	<b>25</b>	25	Yes	701374	0.452
216-086	582	25	25	No	500731	0.448	230-201616101	563	<b>25</b>	25	Yes	701381	-
230-0105101	561	<b>25</b>	25	Yes	448941	0.258	230-210616101	563	<b>25</b>	25	Yes	451576	0.5044
230-0105201	561	<b>25</b>	25	Yes	451460	0.242	230-210616201	563	<b>25</b>	25	Yes	701398	0.474
230-0106101	561	<b>50</b>	50	Yes	706768	-	230-220616101	563	<b>10</b>	10	Yes	448835	0.5
230-0106201	561	<b>50</b>	50	Yes	701091	0.309	230-220616201	563	<b>25</b>	25	Yes	701404	0.47
230-0115101	561	<b>25</b>	25	Yes	451477	0.246	230-230616101	563	<b>25</b>	25	Yes	701411	0.438
230-0115201	561	<b>25</b>	25	Yes	207166	0.234	230-230616201	563	<b>25</b>	25	Yes	701428	-
230-0206101	561	<b>50</b>	50	Yes	448927	0.318	230-231616101	563	<b>25</b>	25	Yes	701435	-
230-0206201	561	<b>50</b>	50	Yes	451484	0.365	230-240616101	563	<b>25</b>	25	Yes	701442	0.456
230-0226301	561	<b>25</b>	25	Yes	701107	0.512	230-240616201	563	<b>25</b>	25	Yes	701459	0.464
230-0316101	561	<b>50</b>	50	Yes	451491	0.342	230-241616101	563	<b>25</b>	25	Yes	701466	0.462
230-0316201	561	<b>50</b>	50	Yes	207180	0.339	230-250616101	563	<b>25</b>	25	Yes	451590	0.454
230-0406101	561	<b>50</b>	50	Yes	451514	0.413	230-250616201	563	<b>25</b>	25	Yes	701473	0.466
230-0406201	561	<b>50</b>	50	Yes	451521	0.408	230-251616101	563	<b>25</b>	25	Yes	701480	0.472
230-0516150	561	<b>50</b>	50	Yes	701114	0.344	230-2606101	564	<b>20</b>	20	Yes	448828	0.47
230-0706101	561	<b>50</b>	50	Yes	701121	0.355	230-2606201	564	<b>20</b>	20	Yes	725677	0.68
230-0706201	561	<b>50</b>	50	Yes	701138	0.36	230-261616101	564	<b>25</b>	25	Yes	701497	0.52
230-0706401	561	<b>50</b>	50	Yes	701145	0.41	230-270616101	564	<b>25</b>	25	Yes	701503	-
230-0716101	561	<b>50</b>	50	Yes	701152	0.347	230-270616201	564	<b>25</b>	25	Yes	715364	-
230-0716201	561	<b>50</b>	50	Yes	701169	0.35	230-270621101	564	<b>25</b>	25	Yes	701510	-
230-0806101	561	<b>50</b>	50	Yes	701176	0.346	230-270625101	564	<b>25</b>	25	Yes	701527	0.736
230-0806201	561	<b>50</b>	50	Yes	701183	0.348	230-271616101	564	<b>25</b>	25	Yes	701534	-
230-0908101	562	<b>12</b>	12	Yes	448903	0.2625	230-271616201	564	<b>25</b>	25	Yes	701541	-
230-0918101	562	<b>12</b>	12	Yes	701190	-	230-271621101	564	<b>25</b>	25	Yes	701558	0.522
230-1005101	562	<b>10</b>	10	Yes	448897	0.59	230-271625101	564	<b>25</b>	25	Yes	701565	0.626
230-1005201	562	<b>10</b>	10	Yes	701206	0.62	230-280616101	564	<b>25</b>	25	Yes	701572	0.432
230-1015101	562	<b>10</b>	10	Yes	701213	0.505	230-280616201	564	<b>25</b>	25	Yes	701589	0.414
230-106101	562	<b>10</b>	10	Yes	203854	0.76	230-281616101	564	<b>25</b>	25	Yes	701596	0.438

Supply

Drainage

Support

Specialties

Appendix

# Numerical Index

Supply

Drainage

Support

Specialties

Appendix

Item No	Page No	Min Qty	Case Qty	UPC Bar-Coded	UPC 6-Digit	Weight (lbs.)	Item No	Page No	Min Qty	Case Qty	UPC Bar-Coded	UPC 6-Digit	Weight (lbs.)
230-2906101	564	<b>10</b>	10	Yes	448811	0.505	230-460616125	566	<b>25</b>	25	Yes	451965	0.282
230-290616201	564	<b>25</b>	25	Yes	451675	0.444	230-460616225	566	<b>25</b>	25	Yes	701824	0.29
230-291616101	564	<b>25</b>	25	Yes	701602	0.464	230-461516125	566	<b>25</b>	25	Yes	701831	0.238
230-300616101	564	<b>25</b>	25	Yes	503435	0.456	230-461616125	566	<b>25</b>	25	Yes	451972	0.268
230-300616201	564	<b>25</b>	25	Yes	701619	0.436	230-461616225	566	<b>25</b>	25	Yes	701848	0.29
230-300621101	564	<b>25</b>	25	Yes	701626	0.48	230-47050650	566	<b>50</b>	50	Yes	451989	0.074
230-300625101	564	<b>25</b>	25	Yes	701633	0.536	230-47050825	566	<b>25</b>	25	Yes	451996	0.14
230-301616101	564	<b>25</b>	25	Yes	701640	0.446	230-47051225	566	<b>25</b>	25	Yes	452009	0.194
230-301621101	564	<b>25</b>	25	Yes	701657	0.484	230-47060825	566	<b>25</b>	25	Yes	452016	0.1625
230-301625101	564	<b>25</b>	25	Yes	701664	-	230-47061225	566	<b>25</b>	25	Yes	452023	0.2652
230-310616101	564	<b>25</b>	25	Yes	701671	0.448	230-47150850	566	<b>50</b>	50	Yes	701855	0.094
230-310616201	564	<b>25</b>	25	Yes	701688	0.482	230-47160625	566	<b>25</b>	25	Yes	701862	0.248
230-311616101	564	<b>25</b>	25	Yes	701695	0.452	230-47161225	566	<b>25</b>	25	Yes	701879	-
230-320616101	565	<b>25</b>	25	Yes	501226	0.456	230-48061625	566	<b>25</b>	25	Yes	502940	0.338
230-320616201	565	<b>25</b>	25	Yes	701701	0.516	230-530608225	567	<b>25</b>	25	Yes	701886	0.154
230-321616101	565	<b>25</b>	25	Yes	207241	0.506	230-53060825	567	<b>25</b>	25	Yes	203823	0.152
230-330616101	565	<b>25</b>	25	Yes	451750	0.412	230-53160825	567	<b>25</b>	25	Yes	701893	0.152
230-330616201	565	<b>25</b>	25	Yes	711786	0.412	230-54060825	567	<b>25</b>	25	Yes	503442	0.152
230-331616101	565	<b>25</b>	25	Yes	451767	0.452	230-54160825	567	<b>25</b>	25	Yes	701909	-
230-40060125	565	<b>25</b>	25	Yes	451774	0.03	230-550608225	567	<b>25</b>	25	Yes	715371	0.154
230-40060450	565	<b>50</b>	50	Yes	451781	0.049	230-55060825	567	<b>25</b>	25	Yes	452085	0.158
230-40060650	565	<b>50</b>	50	Yes	451798	0.075	230-55160825	567	<b>25</b>	25	Yes	452092	0.242
230-40060825	565	<b>25</b>	25	Yes	451804	0.108	230-56060825	567	<b>25</b>	25	Yes	452108	0.154
230-40061225	565	<b>25</b>	25	Yes	451811	0.152	230-56160825	567	<b>25</b>	25	Yes	701916	0.17
230-40160450	565	<b>50</b>	50	Yes	207258	-	230-57060825	566	<b>25</b>	25	Yes	701923	0.196
230-40160650	565	<b>50</b>	50	Yes	451828	0.083	230-58060825	566	<b>25</b>	25	Yes	701930	0.194
230-40160825	565	<b>25</b>	25	Yes	451835	0.108	230-600607101	567	<b>25</b>	25	Yes	448705	0.175
230-40161225	565	<b>25</b>	25	Yes	451842	0.17	230-600609125	567	<b>25</b>	25	Yes	701947	0.188
230-41061625	565	<b>25</b>	25	Yes	451859	0.226	230-600611125	567	<b>25</b>	25	Yes	452115	0.192
230-41161625	565	<b>25</b>	25	Yes	451866	0.21	230-600615125	567	<b>25</b>	25	Yes	452122	0.236
230-44061625	565	<b>25</b>	25	Yes	701718	0.64	230-600624125	567	<b>25</b>	25	Yes	452139	0.562
230-450506132	566	<b>32</b>	32	Yes	451873	0.1094	230-60160725	567	<b>25</b>	25	Yes	207272	0.17
230-450506232	566	<b>32</b>	32	Yes	701725	0.1031	230-60160925	567	<b>25</b>	25	Yes	701954	0.19
230-450508125	566	<b>25</b>	25	Yes	701732	0.124	230-601611125	567	<b>25</b>	25	Yes	452146	0.198
230-450508225	566	<b>25</b>	25	Yes	701749	0.12	230-601615125	567	<b>25</b>	25	Yes	452153	0.24
230-450512116	566	<b>16</b>	16	Yes	451880	0.1688	230-61060725	567	<b>25</b>	25	Yes	701961	0.174
230-450512216	566	<b>16</b>	16	Yes	701756	0.1812	230-61060925	567	<b>25</b>	25	Yes	452160	0.18
230-450606132	566	<b>32</b>	32	Yes	451897	0.122	230-61061225	567	<b>25</b>	25	Yes	207289	0.196
230-450606232	566	<b>32</b>	32	Yes	701763	0.1328	230-61061525	567	<b>25</b>	25	Yes	452177	0.264
230-450608116	566	<b>16</b>	16	Yes	451903	0.1531	230-61160725	567	<b>25</b>	25	Yes	701978	0.172
230-450608216	566	<b>16</b>	16	Yes	701770	0.1812	230-61160925	567	<b>25</b>	25	Yes	701985	0.184
230-450612116	566	<b>16</b>	16	Yes	451910	0.2281	230-611611125	567	<b>25</b>	25	Yes	701992	0.1924
230-450612216	566	<b>16</b>	16	Yes	701787	0.2281	230-61161525	567	<b>25</b>	25	Yes	452184	0.274
230-451506132	566	<b>32</b>	32	Yes	701794	0.1031	230-8006125	568	<b>25</b>	25	Yes	452191	0.132
230-451606132	566	<b>32</b>	32	Yes	451927	0.1297	230-8016125	568	<b>25</b>	25	Yes	702005	0.118
230-451608116	566	<b>16</b>	16	Yes	451934	0.1438	230-8206125	568	<b>25</b>	25	Yes	452207	0.106
230-451608216	566	<b>16</b>	16	Yes	701800	0.1812	230-8216125	568	<b>25</b>	25	Yes	452214	0.129
230-451612116	566	<b>16</b>	16	Yes	451941	0.1969	230-8406101	568	<b>25</b>	25	Yes	448668	0.128
230-460516125	566	<b>25</b>	25	Yes	451958	0.214	230-8506101	568	<b>25</b>	25	Yes	448651	0.1917
230-460516225	566	<b>25</b>	25	Yes	701817	0.2329	230-8516101	568	<b>25</b>	25	Yes	702012	-

Item No	Page No	Min Qty	Case Qty	UPC Bar-Coded	UPC 6-Digit	Weight (lbs.)	Item No	Page No	Min Qty	Case Qty	UPC Bar-Coded	UPC 6-Digit	Weight (lbs.)
230-860625	568	<b>25</b>	25	Yes	702029	-	240-02631C04	574	1	25	Yes	452481	1.302
230-861625	568	<b>25</b>	25	Yes	702036	-	240-0263C04	574	1	25	Yes	452498	1.294
230-8706125	568	<b>25</b>	25	Yes	448644	0.176	240-03531C04	574	1	25	Yes	706577	-
230-8716125	568	<b>25</b>	25	Yes	702043	0.178	240-0353C04	574	1	25	Yes	452504	1.13
230-8806125	568	<b>25</b>	25	Yes	702050	0.178	240-03631C04	574	1	25	Yes	706584	-
230-8816125	568	<b>25</b>	25	Yes	702067	-	240-0363C04	574	1	25	Yes	452511	1.402
230-9006101	568	<b>25</b>	25	Yes	448637	0.386	240-0452C04	573	1	25	Yes	462107	-
230-9506101	568	<b>25</b>	25	Yes	448620	0.086	240-0453C04	573	1	25	Yes	452528	1.086
230-9506GT	465	<b>25</b>	25	No	714862	0.096	240-0454C04	573	1	25	Yes	452542	1.494
230-9506GT	568	<b>25</b>	25	No	714862	0.096	240-04571C04	573	1	25	Yes	452535	1.498
230-9506SGT	568	<b>25</b>	25	No	715487	-	240-0462C04	573	1	25	Yes	452559	1.062
230-9516101	568	<b>25</b>	25	Yes	702074	0.088	240-04631C04	573	1	25	Yes	452566	1.36
231-1506101	569	<b>25</b>	25	Yes	448613	0.252	240-0463C04	573	1	25	Yes	452573	1.288
231-4006101	569	<b>15</b>	15	Yes	448606	0.1533	240-0464C04	573	1	25	Yes	452597	1.856
231-4505101	569	<b>15</b>	15	Yes	448590	0.1033	240-0467C04	573	1	25	Yes	452580	1.896
231-4506101	569	<b>15</b>	15	Yes	448583	0.1433	240-0487C04	573	1	25	Yes	452603	1.752
231-4606101	569	<b>25</b>	25	Yes	448576	0.142	240-0553C04	574	1	25	Yes	207371	-
234-QP	467	<b>25</b>	100	No	300003	0.035	240-05541C04	574	1	25	Yes	452610	1.512
234-QP	570	<b>25</b>	100	No	300003	0.035	240-0554C04	574	1	25	Yes	452627	1.502
234-QP2	467	<b>25</b>	100	No	321572	0.0174	240-0563C04	574	1	25	Yes	207388	-
234-QP2	570	<b>25</b>	100	No	321572	0.0174	240-0564C04	574	1	25	Yes	452634	1.844
239	627	<b>50</b>	50	No	518996	0.08	240-05B531C04	574	1	25	Yes	706591	-
239PK2	627	<b>10</b>	10	Yes	302007	0.1254	240-05B631C04	574	1	25	Yes	706607	-
240-0151C04	573	1	25	Yes	452245	0.652	240-06631C04	573	1	25	Yes	452641	1.3
240-015212C04	573	1	25	Yes	452252	1.04	240-08648R104	574	1	5	Yes	452658	1.85
240-0152C04	573	1	25	Yes	452276	0.866	240-08688R104	574	1	5	Yes	452665	0.35
240-015312C04	573	1	25	Yes	452283	1.266	240-08848C04	574	1	5	Yes	452672	1.56
240-01531C04	573	1	25	Yes	706546	-	240-08948R104	574	1	5	Yes	452696	3.4
240-01539C04	573	1	25	Yes	706553	-	240-09648R104	575	1	5	Yes	452733	1.79
240-0153C04	573	1	25	Yes	452306	1.038	240-09847C04	575	1	5	Yes	452740	1.5
240-0161C04	573	1	25	Yes	452313	0.944	240-09847R104	575	1	5	Yes	452726	1.98
240-0161R104	573	1	25	Yes	448545	0.83	240-09848C04	575	1	5	Yes	452757	1.62
240-016215C04	573	1	25	Yes	207302	-	240-09947C04	575	1	5	Yes	706829	1.68
240-01621C04	573	1	25	Yes	462091	1.17	240-09947R104	575	1	5	Yes	452764	2.1
240-0162C04	573	1	25	Yes	452320	1.046	240-09988R104	575	1	5	Yes	452771	3.48
240-0162R104	573	1	25	Yes	452337	0.986	240-1052C04	576	1	25	Yes	452702	0.758
240-0163121C04	573	1	25	Yes	452344	1.608	240-1062C04	576	1	25	Yes	452719	0.9
240-016312C04	573	1	25	Yes	452351	1.51	240-1151C04	577	1	12	Yes	452795	1.1375
240-01631C04	573	1	25	Yes	452368	1.312	240-1152C04	577	1	12	Yes	452801	1.45
240-01639C04	573	1	25	Yes	706560	-	240-1153C04	577	1	12	Yes	452818	1.8375
240-0163C04	573	1	25	Yes	452382	1.286	240-1161C04	577	1	12	Yes	452825	1.5042
240-0163R104	573	1	25	Yes	452399	1.24	240-1162C04	577	1	12	Yes	452832	1.9167
240-01831C04	573	1	25	Yes	452412	1.234	240-1163C04	577	1	12	Yes	452849	2.125
240-0252C04	574	1	25	Yes	452436	0.89	240-12531C04	577	1	12	Yes	452856	1.8625
240-025315C04	574	1	25	Yes	207319	1.496	240-12631C04	577	1	12	Yes	452863	2.2292
240-02531C04	574	1	25	Yes	452443	1.092	240-1352C04	577	1	12	Yes	706614	-
240-0253C04	574	1	25	Yes	452450	1.098	240-13531C04	577	1	12	Yes	452870	1.95
240-0261C04	574	1	25	Yes	452467	0.942	240-1353C04	577	1	12	Yes	706621	-
240-0262C04	574	1	25	Yes	452474	1.026	240-1362C04	577	1	12	Yes	706638	-
240-026312C04	574	1	25	Yes	502957	-	240-13631C04	577	1	12	Yes	452887	2.2958

Supply

Drainage

Support

Specialties

Appendix

# Numerical Index

Supply

Drainage

Support

Specialties

Appendix

Item No	Page No	Min Qty	Case Qty	UPC Bar-Coded	UPC 6-Digit	Weight (lbs.)	Item No	Page No	Min Qty	Case Qty	UPC Bar-Coded	UPC 6-Digit	Weight (lbs.)
240-1453C04	577	1	12	Yes	452894	1.875	240-406108C25	580	1	25	Yes	453297	0.262
240-1463C04	577	1	12	Yes	452900	2.3	240-406108R125	580	1	25	Yes	453303	0.268
240-1551C12	577	1	12	Yes	452917	0.4458	240-406112C25	580	1	25	Yes	453310	0.401
240-1552C04	577	1	25	Yes	452924	0.484	240-406112R125	580	1	25	Yes	453327	0.4275
240-1553C04	577	1	25	Yes	452931	0.564	240-406118R125	580	1	25	Yes	207548	-
240-1561C01	577	1	12	Yes	448514	0.5458	240-406124R125	580	1	25	Yes	453334	0.926
240-1562C04	577	1	25	Yes	452948	0.576	240-406204C50	580	1	50	Yes	453341	0.164
240-1563C04	577	1	25	Yes	502889	-	240-406206C50	580	1	50	Yes	453358	0.248
240-1661C04	578	1	25	Yes	706430	0.61	240-406206R150	580	1	50	Yes	207555	-
240-1662C04	578	1	25	Yes	452979	0.472	240-406208C25	580	1	25	Yes	453365	0.32
240-1663C04	578	1	25	Yes	452986	0.752	240-406212C25	580	1	25	Yes	453372	0.476
240-175107C24	578	1	24	Yes	207401	0.2167	240-406212R125	580	1	25	Yes	453389	0.456
240-176107C24	578	1	24	Yes	452993	0.2854	240-406306C50	580	1	50	Yes	453396	0.297
240-176212C24	578	1	24	Yes	453006	0.5333	240-406308C25	580	1	25	Yes	453402	0.438
240-176307C24	578	1	24	Yes	453013	0.4833	240-406308R125	580	1	25	Yes	453419	0.436
240-1861C04	577	1	12	Yes	448491	1.9125	240-406312C25	580	1	25	Yes	453426	0.644
240-19875C04	575	1	25	Yes	207432	-	240-406312R125	580	1	25	Yes	453433	0.668
240-20825C04	575	1	25	Yes	453020	1.72	240-416116C25	580	1	25	Yes	453457	0.53
240-20835C04	575	1	25	Yes	453037	1.888	240-416216C25	580	1	25	Yes	453464	0.636
240-2163C04	578	1	25	Yes	453044	0.584	240-416316C25	580	1	25	Yes	706669	-
240-2267C04	575	1	25	Yes	453051	1.184	240-455106C32	581	1	32	Yes	453471	0.2109
240-22836C04	575	1	25	Yes	453068	1.124	240-455108C16	581	1	16	Yes	453488	0.2562
240-22873C04	575	1	10	Yes	207487	-	240-455112C16	581	1	16	Yes	453495	0.3667
240-2287C04	575	1	25	Yes	453075	1.192	240-455112R116	581	1	16	Yes	453501	0.4656
240-276116C04	578	1	25	Yes	453082	1.704	240-455206C32	581	1	32	Yes	453518	0.2781
240-276121C04	578	1	25	Yes	453099	2.092	240-455208C16	581	1	16	Yes	453525	0.3625
240-276216C04	578	1	25	Yes	453105	1.934	240-455212C16	581	1	16	Yes	453532	0.5219
240-276221C04	578	1	25	Yes	207500	-	240-455306C32	581	1	32	Yes	453549	0.3344
240-276316C04	578	1	25	Yes	453112	2.024	240-455308C16	581	1	16	Yes	453556	0.4719
240-276321C04	578	1	25	Yes	207517	2.434	240-455312C16	581	1	16	Yes	453563	0.6344
240-286116C04	578	1	25	Yes	453129	1.684	240-456106C32	581	1	32	Yes	453570	0.2656
240-286216C04	578	1	25	Yes	453136	1.806	240-456108C16	581	1	16	Yes	453587	0.3594
240-2863161C04	578	1	25	Yes	453143	1.754	240-4561106C32	581	1	32	Yes	706676	-
240-306116C04	579	1	25	Yes	453150	1.672	240-4561112C16	581	1	16	Yes	706683	-
240-306121C04	579	1	25	Yes	453167	1.984	240-456112C16	581	1	16	Yes	453594	0.475
240-3062161C04	579	1	25	Yes	207524	2.258	240-456112R106	581	1	16	Yes	448392	0.4906
240-306216C04	579	1	25	Yes	453174	1.746	240-456206C16	581	1	16	Yes	706690	-
240-3063161C04	579	1	25	Yes	453181	2.114	240-456208C16	581	1	16	Yes	453600	0.4219
240-316116C04	579	1	25	Yes	453198	1.336	240-456212C16	581	1	16	Yes	453617	0.5656
240-316216C04	579	1	25	Yes	453204	1.53	240-456306C32	581	1	32	Yes	453624	0.4297
240-316316C04	579	1	25	Yes	706645	-	240-456308C16	581	1	16	Yes	453631	0.5125
240-336213C04	579	1	25	Yes	453211	2.014	240-4563121C16	581	1	16	Yes	453648	0.7469
240-336313C04	579	1	25	Yes	706652	2.114	240-4563121R116	581	1	16	Yes	453655	0.7281
240-405104C50	579	1	50	Yes	453228	0.143	240-456312C16	581	1	16	Yes	453662	0.7531
240-405106C50	579	1	50	Yes	453235	0.182	240-465115C16	581	1	16	Yes	453679	0.6906
240-405108C25	579	1	25	Yes	453242	0.196	240-466116C16	581	1	16	Yes	453686	0.7188
240-405112C25	579	1	25	Yes	453259	0.358	240-466216C16	581	1	16	Yes	706706	0.7188
240-406104C50	580	1	50	Yes	453266	0.134	240-475106C50	581	1	50	Yes	462114	0.18
240-406106C50	580	1	50	Yes	453273	0.198	240-475108C25	581	1	25	Yes	207562	-
240-406106R150	580	1	50	Yes	453280	0.199	240-475112C25	581	1	25	Yes	453693	0.272



Item No	Page No	Min Qty	Case Qty	UPC Bar-Coded	UPC 6-Digit	Weight (lbs.)	Item No	Page No	Min Qty	Case Qty	UPC Bar-Coded	UPC 6-Digit	Weight (lbs.)
240-476106C01	581	1	25	Yes	207579	-	240-706312R125	585	1	25	Yes	454126	0.62
240-476108C25	581	1	25	Yes	453709	0.266	240-706318R125	585	1	25	Yes	454133	0.924
240-476112C25	581	1	25	Yes	453716	0.296	240-718108C25	585	1	25	Yes	454140	0.342
240-476212C25	581	1	25	Yes	502742	0.542	240-8051C25	586	1	25	Yes	454157	0.218
240-486124C04	584	1	12	Yes	453723	1.3042	240-8061C25	586	1	25	Yes	454164	0.248
240-606107C01	584	1	25	Yes	448385	0.342	240-825106C01	586	1	24	Yes	454171	0.2958
240-606108R124	584	1	24	Yes	453747	0.3958	240-825108C01	586	1	12	Yes	454188	0.3708
240-606111C24	584	1	24	Yes	453754	0.525	240-825112C01	586	1	12	Yes	454195	0.4292
240-606111R124	584	1	24	Yes	453761	0.5271	240-825112R101	586	1	24	Yes	454201	0.4312
240-606115C24	584	1	24	Yes	453778	0.6125	240-8251C25	586	1	25	Yes	454218	0.272
240-606118R124	584	1	24	Yes	453785	0.725	240-826112C01	586	1	12	Yes	454225	0.575
240-606124R124	584	1	24	Yes	453792	0.9208	240-8261C25	586	1	25	Yes	454249	0.274
240-606136R124	584	1	24	Yes	453730	1.3083	240-8451C25	586	1	25	Yes	454263	0.236
240-606211C24	584	1	24	Yes	453815	0.6188	240-8461C25	586	1	50	Yes	454270	0.296
240-606215C24	584	1	24	Yes	706713	-	240-8561R112	586	1	12	Yes	454287	0.7625
240-606224R124	584	1	24	Yes	207609	1.2583	240-8564C01	586	1	12	Yes	448323	0.7042
240-6063111C24	584	1	24	Yes	453839	0.8438	240-8664C12	586	1	12	Yes	454294	0.7375
240-6063112R124	584	1	24	Yes	453846	0.8312	240-8764C06	586	1	12	Yes	448316	0.8292
240-6063181R124	584	1	24	Yes	453853	1.1354	240-8864C12	586	1	12	Yes	454300	0.7917
240-6063241C24	584	1	24	Yes	453860	1.4396	240-9051C50	586	1	50	Yes	454317	0.397
240-6063241R124	584	1	24	Yes	453877	1.4583	240-9051R150	586	1	50	Yes	454324	0.433
240-606324R124	584	1	24	Yes	453969	1.4542	240-9052C50	586	1	50	Yes	454331	0.537
240-616107C01	585	1	24	Yes	453884	0.2646	240-9061C25	586	1	50	Yes	454348	0.517
240-616111C24	585	1	24	Yes	706720	0.4812	240-9061R150	586	1	50	Yes	454355	0.538
240-616111R124	585	1	24	Yes	453891	0.4958	240-9062C50	586	1	50	Yes	454362	0.608
240-616115C24	585	1	24	Yes	453907	0.5042	240-90631C50	586	1	50	Yes	454379	0.811
240-616115R124	585	1	24	Yes	453914	0.5271	240-90631R150	586	1	50	Yes	454386	0.815
240-616124C24	585	1	24	Yes	453921	0.9417	240-9394R104	576	1	15	Yes	454393	3.35
240-616124R124	585	1	24	Yes	453938	0.7875	240-9464R104	576	1	25	Yes	454409	1.538
240-616215C24	585	1	24	Yes	453945	0.6396	240-98720625	578	1	100	Yes	454416	0.896
240-616311C24	585	1	24	Yes	706737	-	240-996208R116	588	1	50	Yes	454423	0.288
240-616311R124	585	1	24	Yes	453952	0.6812	241-20135	627	1	48	No	454430	0.25
240-626124R120	585	1	20	Yes	453976	1.0275	242-10	625	1	10	Yes	501141	0.5589
240-636312R124	585	1	24	Yes	448378	1.2542	242-20	625	1	100	Yes	501158	0.0709
240-636316R116	585	1	16	Yes	453983	1.8031	242-20102	625	1	10	Yes	501165	0.6129
240-703212C25	585	1	25	Yes	453990	0.506	242-20116	625	1	25	Yes	501189	0.0787
240-705206C50	585	1	50	Yes	454003	0.221	242-25	625	1	10	Yes	501196	0.1616
240-705208C25	585	1	25	Yes	454010	0.32	245-12530C04	593	1	50	Yes	454447	0.588
240-705212C25	585	1	25	Yes	454027	0.462	245-12832C04	592	1	5	Yes	448309	1.2
240-705212R125	585	1	25	Yes	454034	0.446	245-12930C04	593	1	50	Yes	448293	0.584
240-705312C25	585	1	25	Yes	454041	0.514	245-13640C04	593	1	50	Yes	454454	0.382
240-705312R125	585	1	25	Yes	454058	0.5	245-16440C04	591	1	20	Yes	448279	0.737
240-705318C25	585	1	25	Yes	706744	-	245-16450C04	591	1	20	Yes	448231	0.85
240-706206C06	585	1	50	Yes	448347	0.254	245-16452C04	591	1	20	Yes	448224	0.995
240-706208C25	585	1	25	Yes	454065	0.31	245-16460C04	592	1	50	Yes	448200	0.852
240-706212C25	585	1	25	Yes	454072	0.488	245-16462C04	592	1	50	Yes	448194	0.824
240-706212R125	585	1	25	Yes	454089	0.462	245-16470C04	591	1	50	Yes	448170	0.827
240-706218R125	585	1	25	Yes	454096	0.682	245-16520C04	591	1	50	Yes	448149	0.3735
240-706224R125	585	1	25	Yes	454102	1.048	245-16522C04	591	1	50	Yes	448132	1.06
240-706312C25	585	1	25	Yes	454119	0.626	245-16530C04	592	1	24	Yes	448125	0.9229

Supply

Drainage

Support

Specialties

Appendix

# Numerical Index

Supply

Drainage

Support

Specialties

Appendix

Item No	Page No	Min Qty	Case Qty	UPC Bar-Coded	UPC 6-Digit	Weight (lbs.)	Item No	Page No	Min Qty	Case Qty	UPC Bar-Coded	UPC 6-Digit	Weight (lbs.)
245-16540C04	592	1	50	Yes	448118	0.813	280-A266617	46	<b>50</b>	1000	No	567086	0.0022
245-16550C04	592	1	50	Yes	448095	0.846	280-A266617	137	<b>50</b>	1000	No	567086	0.0022
245-16560C04	592	1	50	Yes	448088	0.854	280-A266627	46	<b>25</b>	25	No	567093	0.0736
245-16950B204	593	1	5	Yes	454478	1.21	280-A266627	137	<b>25</b>	25	No	567093	0.0736
245-52100C04	594	1	100	Yes	448064	0.471	280-A266637	46	<b>25</b>	25	No	567109	0.108
245-56400C01	594	25	100	Yes	448057	0.43	280-A266637	137	<b>25</b>	25	No	567109	0.108
245-96401C01	594	1	50	Yes	448026	0.14	281-072	618	1	12	Yes	556615	0.4745
245-96440C01	594	1	25	Yes	448019	0.16	283-S04112C00	617	<b>25</b>	100	No	454553	0.1075
245-96490C04	594	1	50	Yes	448002	0.111	283-S04112R100	617	<b>25</b>	100	No	454560	0.1065
245-96520C01	594	1	50	Yes	447999	0.186	283-S04116C00	617	<b>25</b>	100	No	462145	0.1515
245-96540C01	594	1	50	Yes	454515	0.086	283-S04120C00	617	<b>25</b>	100	No	454577	0.0335
245-99649C04	594	1	10	Yes	462121	0.08	283-S04120R100	617	<b>25</b>	100	No	454584	0.1905
249	627	<b>25</b>	25	Yes	501202	0.28	283-S04130C50	617	<b>25</b>	100	No	454591	0.304
249-20135	627	1	50	Yes	501219	0.26	283-S04130R150	617	<b>25</b>	100	No	454607	0.28
250-11	451	1	4	Yes	501769	0.6041	283-S04136C50	617	<b>25</b>	100	No	454614	0.296
250-11A	453	1	6	Yes	105110	0.325	283-S04136R100	617	<b>25</b>	100	No	454621	0.298
250-11AC	453	1	8	Yes	501776	1.1475	283-S05112R150	617	<b>50</b>	50	No	501516	0.111
250-11P	452	1	6	Yes	105127	0.325	283-S05120R150	617	<b>50</b>	50	No	501523	0.1863
250-11PC	452	1	8	Yes	501813	1.3131	283-S06112C50	617	<b>25</b>	100	No	454638	0.1445
250-11TB	453	1	6	Yes	100658	0.5033	283-S06112R150	617	<b>25</b>	100	No	454645	0.144
250-11TW	452	1	6	Yes	100641	0.5533	283-S06120C50	617	<b>25</b>	100	No	454652	0.21
250-12	451	1	4	Yes	501332	0.6425	283-S06120R150	617	<b>25</b>	100	No	454669	0.23
250-122AB	453	<b>50</b>	50	Yes	501981	0.2614	283-T24112C00	617	<b>25</b>	100	No	454676	0.1335
250-122AC	453	1	8	Yes	501950	1.495	283-T24120C00	617	<b>25</b>	100	No	454683	0.1965
250-122P	452	1	6	Yes	327192	0.3667	283-T25112C00	617	<b>25</b>	100	No	462152	0.108
250-122PB	452	<b>50</b>	50	Yes	502025	0.3044	283-T25116C00	617	<b>25</b>	100	No	102614	0.16
250-122PC	452	1	8	Yes	502001	1.7625	283-T25120C00	617	<b>25</b>	100	No	454690	0.2015
250-12A	453	1	6	Yes	105141	0.3217	285-100	617	<b>100</b>	1000	No	501448	0.0007
250-12AC	453	1	8	Yes	501752	2.685	285-100	617	<b>100</b>	1000	No	501448	0.0007
250-12P	452	1	6	Yes	105134	0.3667	285-100	617	<b>100</b>	1000	No	501448	0.0007
250-12PC	452	1	8	Yes	501844	1.5438	285-S0412000	617	<b>100</b>	100	No	207654	0.055
250-696122A	203	1	6	Yes	502032	0.8817	285-S0413000	617	<b>100</b>	100	No	454713	0.0775
250-696122A	453	1	6	Yes	502032	0.8817	285-S0413600	617	<b>100</b>	100	No	454720	0.086
250-696122P	203	1	6	Yes	502049	0.8283	285-T2411200	617	<b>100</b>	100	No	207661	-
250-696122P	452	1	6	Yes	502049	0.8283	285-T2412000	617	<b>100</b>	100	No	207678	0.0535
250-696R122A	203	1	6	Yes	410948	1.0333	289-IMK04	618	<b>5</b>	5	Yes	206510	0.55
250-696R122A	453	1	6	Yes	410948	1.0333	290-20180	570	<b>5</b>	25	No	501530	0.035
250-696R122P	203	1	6	Yes	410931	0.9833	290-20180	627	<b>5</b>	25	No	501530	0.035
250-696R122P	452	1	6	Yes	410931	0.9833	290-20185	627	1	12	Yes	501554	0.1182
270-525	588	25	100	No	454522	0.325	290-20200	595	1	10	Yes	501561	0.8028
270-6	588	25	25	No	501325	0.38	290-20320	625	<b>100</b>	1000	No	501646	0.0053
272-5625	588	25	100	No	454539	0.4115	290-20320PK2	625	1	12	Yes	566157	0.0531
272-6	588	25	25	No	501349	0.5219	290-20322	625	<b>100</b>	1000	No	501653	0.002
274-5	588	<b>10</b>	100	No	501356	0.0635	290-20322PK2	625	1	12	Yes	566164	0.0334
274-6	588	<b>10</b>	100	No	501363	0.0698	290-20324	625	<b>100</b>	1000	No	501660	0.004
274-7	588	<b>10</b>	100	No	501370	0.062	290-20324PK2	625	1	12	Yes	566171	0.0414
280-A266537	46	<b>10</b>	2500	No	567062	0.005	290-20480	618	<b>50</b>	500	No	501714	0.0165
280-A266537	137	<b>10</b>	2500	No	567062	0.005	290-20482	618	<b>50</b>	500	No	501721	0.0245
280-A266607	46	<b>50</b>	1000	No	567079	0.0017	290-20514C04	594	1	25	Yes	502995	0.726
280-A266607	137	<b>50</b>	1000	No	567079	0.0017	290-20515C04	594	1	25	Yes	454751	1.458
							290-20553C04	594	1	50	Yes	447852	1

Item No	Page No	Min Qty	Case Qty	UPC Bar-Coded	UPC 6-Digit	Weight (lbs.)	Item No	Page No	Min Qty	Case Qty	UPC Bar-Coded	UPC 6-Digit	Weight (lbs.)
290-20630C04	595	1	50	Yes	454768	0.3	305-7120	763	1	8	Yes	711830	3.6188
290-206322C04	595	1	50	Yes	454775	0.409	305-7123	45	1	8	Yes	711847	3.8
290-20632C04	595	1	50	Yes	454782	0.44	305-7123	763	1	8	Yes	711847	3.8
290-20635C04	595	1	50	Yes	454799	0.2	305-7130	45	1	8	Yes	711861	3.7375
290-21100	624	<b>6</b>	48	Yes	501974	0.0542	305-7130	763	1	8	Yes	711861	3.7375
290-21104	624	<b>6</b>	48	Yes	501998	0.0435	305-802	47	1	20	Yes	714947	2.3
290-21110	624	<b>5</b>	250	Yes	502018	0.0844	305-802	764	1	20	Yes	714947	2.3
290-363020C01	595	1	25	Yes	447814	0.186	305-803	47	1	20	Yes	714954	2.5
290-363520C01	595	1	25	Yes	447807	0.196	305-803	764	1	20	Yes	714954	2.5
290-3650501	595	1	50	Yes	454805	0.176	305-804	47	1	10	Yes	714961	2.8
290-630223C04	595	1	50	Yes	447784	0.15	305-804	764	1	10	Yes	714961	2.8
290-634223C04	595	<b>1</b>	25	Yes	447777	1.058	305-82TX	47	1	10	Yes	500175	4.6495
291-30380	624	1	10	Yes	502650	0.545	305-82TX	764	1	10	Yes	500175	4.6495
291-30500	618	<b>12</b>	240	No	502834	0.0052	305-84TX	47	1	10	Yes	501677	5.395
291-30500	739	<b>12</b>	240	No	502834	0.0052	305-84TX	764	1	10	Yes	501677	5.395
300-12	768	12	12	No	500120	0.4583	305-85TX	47	1	12	Yes	501738	0.1808
300-12B	768	1	25	No	500137	0.3401	305-85TX	764	1	12	Yes	501738	0.1808
300-20	768	4	4	No	500205	1.08	305-92TX	47	1	10	Yes	501905	2.63
300-20B	768	6	6	No	504173	1.1031	305-92TX	764	1	10	Yes	501905	2.63
301-061	768	<b>5</b>	100	No	500373	0.0396	305-995	45	1	200	Yes	711878	0.25
301-062	768	10	10	No	500267	0.376	305-995	763	1	200	Yes	711878	0.25
301-065	768	20	20	No	500366	0.17	305-999	47	1	40	Yes	711885	0.9212
304-06	769	<b>24</b>	24	Yes	520432	0.0771	305-999	763	1	40	Yes	711885	0.9212
304-08	47	<b>12</b>	72	Yes	510150	0.276	305-A139092	48	1	10	Yes	566874	2.5287
304-08	767	<b>12</b>	72	Yes	510150	0.276	305-A139092	767	1	10	Yes	566874	2.5287
304-1	47	1	50	Yes	500571	0.0726	305-A139092B	48	1	25	Yes	566089	0.393
304-1	767	1	50	Yes	500571	0.0726	305-A139092B	767	1	25	Yes	566089	0.393
304-11	48	<b>12</b>	12	Yes	567161	0.6208	305Q2	137	24	24	Yes	400468	0.0179
304-11	767	<b>12</b>	12	Yes	567161	0.6208	305Q2	772	24	24	Yes	400468	0.0179
304-12	47	<b>12</b>	12	Yes	566119	0.3333	305Q23PK1	137	<b>12</b>	12	Yes	411648	0.0343
304-12	767	<b>12</b>	12	Yes	566119	0.3333	305Q23PK1	772	<b>12</b>	12	Yes	411648	0.0343
304-12B	47	1	12	Yes	566102	2.4279	305Q3	137	24	24	Yes	400482	0.0292
304-12B	767	1	12	Yes	566102	2.4279	305Q3	772	24	24	Yes	400482	0.0292
304-20	767	1	24	Yes	566461	0.2333	305Q4	137	12	12	Yes	400499	0.0421
304-25	767	1	10	Yes	566201	0.563	305Q4	772	12	12	Yes	400499	0.0421
304-30	767	1	10	Yes	556219	0.8366	305Q4PK1	137	<b>5</b>	400	Yes	400499	0.0295
304-32	767	1	20	Yes	556226	0.0988	305Q4PK1	772	<b>5</b>	400	Yes	400499	0.0295
305-521PK	769	1	5	Yes	566737	8.9	305Q5	137	5	5	Yes	408006	0.345
305-521PKB	769	1	10	No	566812	0.39	305Q5	772	5	5	Yes	408006	0.345
305-7023	45	1	10	Yes	711809	3.445	305Q6	137	1	1	Yes	408013	0.365
305-7023	763	1	10	Yes	711809	3.445	305Q6	772	1	1	Yes	408013	0.365
305-7040	45	1	10	Yes	711854	2.8	305Q7	137	1	1	Yes	407979	0.438
305-7040	763	1	10	Yes	711854	2.8	305Q7	772	1	1	Yes	407979	0.438
305-7050	45	1	10	Yes	711793	5.12	305-RT	209	1	10	Yes	102829	0.285
305-7050	763	1	10	Yes	711793	5.12	305-RT	772	1	10	Yes	102829	0.285
305-7095	45	1	5	Yes	711816	6.11	305-W23KIT	78	1	5	Yes	204790	4.628
305-7095	763	1	5	Yes	711816	6.11	305-W23KIT	764	1	5	Yes	204790	4.628
305-7110	45	1	8	Yes	711823	3.5938	305-W2H	78	1	20	Yes	204806	0.455
305-7110	763	1	8	Yes	711823	3.5938	305-W2H	764	1	20	Yes	204806	0.455
305-7120	45	1	8	Yes	711830	3.6188	305-W3H	78	1	20	Yes	204813	0.526

Supply

Drainage

Support

Specialties

Appendix

# Numerical Index

Supply

Drainage

Support

Specialties

Appendix

Item No	Page No	Min Qty	Case Qty	UPC Bar-Coded	UPC 6-Digit	Weight (lbs.)	Item No	Page No	Min Qty	Case Qty	UPC Bar-Coded	UPC 6-Digit	Weight (lbs.)
305-W3H	764	1	20	Yes	204813	0.526	390-50117	773	1	25	Yes	504623	0.2227
305-W4H	78	1	20	Yes	204820	0.712	390-50128	773	1	12	Yes	504678	0.3194
305-W4H	764	1	20	Yes	204820	0.712	390-50130	771	1	25	Yes	504685	1.1512
305-WT	78	1	10	Yes	204837	2.072	390-50132	771	1	12	Yes	504692	0.2742
305-WT	764	1	10	Yes	204837	2.072	390-50133	771	1	12	Yes	504708	0.4203
305-X665	14	<b>1</b>	1	Yes	447579	33.6	390-50134	771	1	12	Yes	507341	0.3583
305-X665	764	<b>1</b>	1	Yes	447579	33.6	390-50138	773	<b>1</b>	12	Yes	504739	0.0725
306-10	770	10	50	Yes	504340	0.949	390-50153	769	<b>10</b>	100	Yes	500687	0.1733
307-616	640	1	10	Yes	400321	0.3955	390-50154	769	<b>10</b>	100	Yes	500694	0.0512
307-616	773	1	10	Yes	400321	0.3955	390-50160	775	1	25	Yes	501608	0.386
307-625	640	1	6	Yes	400130	0.9083	390-50163	769	<b>10</b>	100	Yes	500656	0.2977
307-625	771	1	6	Yes	400130	0.9083	390-50164	769	<b>10</b>	100	Yes	500663	0.026
308-2	773	1	12	Yes	556257	2.5488	390-50185	772	1	10	Yes	504951	0.457
310-05	774	1	12	Yes	290007	0.7973	390-50197	770	1	20	Yes	504999	1.8151
310-10	774	1	24	No	556325	0.1206	390-50198	771	1	20	Yes	505002	0.46
310-12	774	1	10	Yes	566126	0.347	390-50200	775	<b>10</b>	50	No	505026	0.1101
311-10	771	1	5	Yes	504388	2.1313	402-10	632	<b>24</b>	24	No	566638	0.4877
312-2	774	1	12	Yes	504395	1.1375	402-410	632	<b>24</b>	24	Yes	519344	0.6074
313-20	770	1	12	Yes	566379	0.5667	402-427	632	<b>24</b>	24	Yes	519405	0.5479
314-10	772	12	12	Yes	504418	0.3362	402-440	632	<b>24</b>	24	Yes	508935	0.6621
314-12	772	12	12	Yes	566324	0.3556	410-PB	631	<b>50</b>	50	Yes	519009	0.094
315-1	767	10	100	No	504432	0.015	411-PB	631	<b>50</b>	50	Yes	519061	0.121
315-10	767	12	60	No	504449	0.4566	412-PB	631	<b>50</b>	50	Yes	519016	0.103
316-1	770	1	12	Yes	566409	0.2168	414-PB	631	<b>50</b>	50	Yes	519023	0.1445
316-2	770	1	12	Yes	566416	0.3469	415-PB	631	<b>50</b>	50	Yes	505118	0.1425
318-4	773	1	5	Yes	566430	0.6511	416-PB	631	<b>50</b>	50	Yes	519030	0.1245
318-9	770	1	10	Yes	566447	0.3638	417	631	<b>100</b>	1000	No	505149	0.0094
319-15	775	<b>50</b>	50	No	504463	0.3	418	631	<b>100</b>	1000	Yes	505156	0.0125
319-20	775	<b>50</b>	50	No	504470	0.34	419	631	<b>100</b>	5000	No	505163	0.0061
319-31	775	<b>50</b>	50	No	504487	0.3168	425	631	<b>100</b>	100	No	304100	0.0199
330-260	783	<b>24</b>	24	Yes	504494	1.55	425-PB	631	<b>50</b>	50	Yes	505262	0.042
332-260	783	<b>24</b>	24	Yes	504500	2.0563	427	631	<b>100</b>	100	No	505316	0.0238
335-260	784	<b>100</b>	500	Yes	504517	0.024	427-PB	631	<b>50</b>	50	Yes	510136	0.0505
335-263	784	<b>70</b>	350	Yes	504524	0.0384	440-2W	631	1	25	Yes	556608	0.1189
335-520	784	<b>100</b>	500	Yes	509253	0.028	442-2B	631	25	25	Yes	506467	0.0094
335-523	784	<b>70</b>	350	Yes	504548	0.0428	442-2W	631	1	25	Yes	566584	0.0621
355-05PK2	471	1	10	Yes	504555	0.5298	452-PB	633	<b>50</b>	50	Yes	304247	0.2289
355-100PK1	471	<b>1</b>	10	Yes	722300	-	460-10	632	<b>100</b>	1000	No	505354	0.0118
355-15PK1	471	1	10	Yes	518019	0.7865	460-10J	632	<b>1</b>	1	Yes	519047	2.12
355-30PK1	471	1	10	Yes	518033	0.7513	460-11300	632	1	10	No	315106	0.135
355-60PK1	471	1	10	Yes	518064	0.7913	460-11310	632	1	10	No	315120	0.1349
356-100PK1	471	1	10	Yes	518606	0.3221	460-20	632	<b>100</b>	1000	No	505408	0.0118
356-300PK1	471	1	10	Yes	377357	0.3417	460-20J	632	<b>1</b>	1	Yes	519054	2.835
356-30PK1	471	1	10	Yes	504579	0.3223	490-10108	636	1	25	Yes	505484	0.1126
356-60PK1	471	1	10	Yes	504586	0.3587	490-10110	636	1	25	Yes	505507	0.1224
360-15PK1	471	1	10	Yes	518514	0.3633	490-10112	636	1	25	Yes	505521	0.6314
360-300PK1	471	1	10	No	520302	0.455	490-10115	636	1	25	Yes	505538	0.1468
390-50105	768	1	25	Yes	500243	0.0517	490-10117	636	1	25	Yes	202765	0.094
390-50110	774	1	25	Yes	504609	0.0848	490-10120	636	1	25	Yes	505552	0.084
390-50115	774	1	24	Yes	504616	0.0938	490-10121	636	1	25	Yes	505569	0.1264

Item No	Page No	Min Qty	Case Qty	UPC Bar-Coded	UPC 6-Digit	Weight (lbs.)	Item No	Page No	Min Qty	Case Qty	UPC Bar-Coded	UPC 6-Digit	Weight (lbs.)
490-10122	636	1	25	Yes	505576	0.0205	500-2	489	<b>100</b>	500	No	200013	0.0143
490-10206	636	1	25	Yes	505637	0.1672	500-3	489	<b>100</b>	500	No	200020	0.0178
490-10211	636	1	50	Yes	505651	0.1298	501-0	489	<b>100</b>	500	No	265968	0.018
490-10302	636	1	25	Yes	505668	0.0904	501-1	489	<b>100</b>	500	No	265920	0.019
490-10312	636	1	25	Yes	505705	0.0904	501-2	489	<b>100</b>	500	No	265937	0.0133
490-10320	636	1	50	Yes	505743	0.0382	501-2PK	489	<b>100</b>	100	Yes	204233	0.009
490-10325	634	1	12	Yes	505750	0.303	501-2PK2	489	<b>10</b>	10	Yes	204226	0.15
490-10340	636	1	25	Yes	505781	0.106	501-2PK3	489	<b>1</b>	10	Yes	204240	0.779
490-10341	636	1	25	Yes	505798	0.022	501-3	489	<b>100</b>	500	No	265944	0.0152
490-10451	636	<b>24</b>	24	Yes	505965	0.1812	501-3PK	489	<b>100</b>	100	Yes	204271	0.011
490-10465	634	1	12	Yes	505989	1.2447	501-3PK2	489	10	10	Yes	204264	0.16
490-10500	633	1	50	Yes	506016	0.2806	501-3PK3	489	<b>1</b>	10	Yes	204288	0.995
490-10540	633	<b>10</b>	10	No	506047	0.3037	501-4	489	<b>100</b>	100	No	265951	0.0362
490-10541	633	<b>10</b>	10	No	506054	0.1857	501-4PK	489	<b>100</b>	100	Yes	204301	0.0304
490-10542	633	<b>10</b>	10	No	506061	0.2347	501-5	489	<b>100</b>	100	No	200082	0.0412
490-10543	633	<b>10</b>	10	No	506078	0.411	501-5PK	489	<b>100</b>	100	Yes	204318	0.0295
490-10545	633	<b>10</b>	10	No	506092	0.3215	501-6	489	<b>100</b>	100	No	200099	0.0556
490-10546	633	<b>10</b>	10	No	304469	0.4445	501-6PK	489	<b>100</b>	100	Yes	204325	0.036
490-10547	633	<b>10</b>	10	No	506115	0.473	501-7	489	<b>100</b>	100	No	200105	0.0444
490-10548	633	<b>10</b>	10	No	506122	0.7435	502-1	489	<b>100</b>	100	No	204004	0.018
490-10555	633	1	25	Yes	506139	0.3507	502-2	489	<b>100</b>	100	No	265524	0.0188
490-10560	633	1	25	Yes	506146	0.356	502-2PK2	489	<b>10</b>	10	Yes	204028	0.2255
490-10565	633	1	25	Yes	506153	0.382	502-3	489	<b>100</b>	100	No	265548	0.0265
490-10570	633	1	25	Yes	506160	0.542	502-3PK2	489	<b>10</b>	10	Yes	204066	0.257
490-10572	633	1	25	Yes	506177	0.5624	502-4	489	<b>100</b>	100	No	265555	0.044
490-10575	633	1	25	Yes	506184	0.3517	502-4PK2	489	<b>10</b>	10	Yes	203922	0.192
490-10585	633	1	25	Yes	506191	0.468	502-5	489	<b>50</b>	50	No	265562	0.06
490-10656	633	<b>25</b>	25	Yes	506214	0.078	502-5PK2	489	<b>10</b>	10	Yes	203939	0.26
490-10661	633	<b>25</b>	25	Yes	506238	0.142	502-6	489	<b>50</b>	50	No	265579	0.0595
490-10666	633	<b>25</b>	25	Yes	506252	0.154	502-6PK2	489	<b>10</b>	10	Yes	267474	0.24
490-10673	633	<b>25</b>	25	Yes	506290	0.1	502-7	489	<b>50</b>	50	No	265517	0.096
490-10676	633	<b>25</b>	25	Yes	506313	0.064	502-75	489	<b>25</b>	25	No	200174	0.1608
490-10700	636	1	12	Yes	506320	0.0792	502-7PK	489	<b>50</b>	50	Yes	204165	0.104
490-1080M2KIT	634	<b>1</b>	5	Yes	457530	1.19	502-7PK2	489	<b>10</b>	10	Yes	267481	0.4012
490-11100	635	1	25	Yes	506337	0.216	502-8	489	<b>25</b>	25	No	265531	0.1832
490-11120	635	1	15	Yes	506351	0.2833	502-8PK	489	<b>15</b>	15	Yes	204189	0.178
490-11140	635	1	12	Yes	506375	0.1681	502-9	489	<b>25</b>	25	No	200198	0.24
490-11150	634	1	12	Yes	506405	0.6612	502-9PK	489	<b>10</b>	10	Yes	204196	0.24
490-11151	634	1	12	Yes	506412	0.3766	505-24	518	<b>100</b>	100	No	200273	0.047
490-11152	634	<b>5</b>	25	Yes	506429	0.0889	505-29	518	<b>100</b>	100	No	265494	0.0307
490-11157	635	1	12	Yes	506450	0.1481	505-34	518	<b>100</b>	100	No	200341	0.0488
490-11159	635	1	12	Yes	506474	0.3451	505-39	518	<b>100</b>	100	No	265500	0.0278
490-11240	632	<b>25</b>	500	Yes	506566	0.0378	505-44	518	<b>50</b>	50	No	266965	0.047
490-11320	442	1	10	Yes	303462	0.185	505-49	518	<b>50</b>	50	No	200327	0.0339
490-11320	636	1	10	Yes	303462	0.185	505-5	518	<b>25</b>	100	No	201164	0.0419
490-11322	443	1	10	Yes	303486	0.8169	506-26	490	<b>50</b>	500	No	265692	0.0645
490-11322	636	1	10	Yes	303486	0.8169	506-26C	490	<b>50</b>	500	No	205681	0.062
490-11520	636	<b>5</b>	25	No	506610	0.0779	506-26CPK2	490	<b>5</b>	5	Yes	205667	0.324
490-11522	636	<b>5</b>	25	No	506627	0.0609	506-26P	490	<b>50</b>	500	No	265746	0.066
490-11530	636	<b>5</b>	25	No	506634	0.0589	506-26PK2	490	<b>5</b>	5	Yes	205063	0.307

Supply

Drainage

Support

Specialties

Appendix

# Numerical Index

Supply

Drainage

Support

Specialties

Appendix

Item No	Page No	Min Qty	Case Qty	UPC Bar-Coded	UPC 6-Digit	Weight (lbs.)	Item No	Page No	Min Qty	Case Qty	UPC Bar-Coded	UPC 6-Digit	Weight (lbs.)
506-34	490	<b>50</b>	500	No	265708	0.044	515-3GPK2	544	<b>10</b>	10	Yes	261038	0.1803
506-34P	490	<b>50</b>	500	No	265753	0.046	515-4CPK2	544	<b>10</b>	10	Yes	261243	0.1413
506-36	490	<b>50</b>	500	No	265715	0.0608	515-4GPK2	544	<b>10</b>	10	Yes	261045	0.1983
506-36C	490	<b>50</b>	500	No	265791	0.064	515-5CPK2	544	<b>10</b>	10	Yes	261250	0.2341
506-36CPK2	490	<b>5</b>	5	Yes	205742	0.324	515-5GPK2	544	<b>10</b>	10	Yes	261052	0.2891
506-36P	490	<b>50</b>	500	No	265760	0.065	515-6CPK2	544	<b>10</b>	10	Yes	261267	0.2924
506-36PK2	490	<b>5</b>	5	Yes	205148	0.313	515-6GPK2	544	<b>10</b>	10	Yes	261069	0.2624
506-38P	490	<b>50</b>	500	No	265777	0.8	515-7CPK2	544	<b>10</b>	10	Yes	261274	0.4064
506-46	490	<b>50</b>	500	No	205247	0.0661	515-7GPK2	544	<b>10</b>	10	Yes	261076	0.3288
506-46C	490	<b>50</b>	500	No	265814	0.0662	515-8GPK2	544	<b>10</b>	10	Yes	261083	0.8826
506-46CPK2	490	<b>5</b>	5	Yes	205827	0.336	515-9GPK2	544	<b>10</b>	10	Yes	261090	0.6371
506-46P	490	<b>50</b>	500	No	265784	0.0658	516-2CB	544	100	100	No	201171	0.082
506-46PK2	490	<b>5</b>	5	Yes	205223	0.307	516-2CPK2	544	<b>20</b>	20	Yes	263421	0.11
506-56	490	<b>50</b>	500	No	200594	0.0576	516-2GB	545	100	100	No	201324	0.1
506-66	490	<b>50</b>	500	No	200662	0.06	516-2GPK2	544	<b>20</b>	20	Yes	263223	0.1225
508-2B	533	<b>25</b>	25	No	201126	0.073	516-3CPK2	544	<b>20</b>	20	Yes	263438	0.1244
508-2PK	533	<b>25</b>	25	Yes	203519	0.0791	516-3GB	545	100	100	No	201362	0.11
508-3B	533	<b>25</b>	25	No	201133	0.076	516-3GPK2	544	<b>20</b>	20	Yes	263230	0.135
508-3PK	533	<b>25</b>	25	Yes	203557	0.0671	516-4CB	544	100	100	No	201195	0.087
508-4B	533	<b>25</b>	25	No	201157	0.0842	516-4CPK2	544	<b>10</b>	10	Yes	263445	0.1703
508-4PK	533	<b>25</b>	25	Yes	203588	0.082	516-4GB	545	100	100	No	201386	0.096
510-6PK	502	<b>20</b>	20	Yes	260666	0.2452	516-4GPK2	544	<b>10</b>	10	Yes	263247	0.185
510-6VPK	502	<b>10</b>	10	Yes	260864	0.3044	516-5CB	544	100	100	No	201256	0.101
510-7PK	502	<b>20</b>	20	Yes	260673	0.2933	516-5CPK2	544	<b>10</b>	10	Yes	263452	0.175
510-7VPK	502	<b>10</b>	10	Yes	260871	0.3165	516-5GB	545	100	100	No	201393	0.102
510-8PK	502	<b>20</b>	20	Yes	260697	0.3982	516-5GPK2	544	<b>10</b>	10	Yes	263254	0.215
510-8VPK	502	<b>10</b>	10	Yes	260895	0.3917	516-6CB	544	100	100	No	201294	0.114
510-9PK	502	<b>20</b>	20	Yes	260703	0.4362	516-6CPK2	544	<b>10</b>	10	Yes	263469	0.19
510-9VPK	502	<b>10</b>	10	Yes	260901	0.4838	516-6GPK2	544	<b>10</b>	10	Yes	263261	0.27
512-26PK	490	<b>50</b>	50	Yes	215666	0.079	516-7CB	544	100	100	No	201416	0.15
512-36PK	490	<b>50</b>	50	Yes	215741	0.069	516-7CPK2	544	<b>10</b>	10	Yes	263476	0.243
512-46PK	490	<b>50</b>	50	Yes	215826	0.086	516-7GPK2	544	<b>10</b>	10	Yes	263278	0.2985
513-26PK	491	<b>25</b>	25	Yes	215093	0.0638	517-C02	545	100	100	Yes	203564	0.0878
513-36PK	491	<b>25</b>	25	Yes	215178	0.1021	517-C03	545	100	100	Yes	203595	0.1005
514-G02	543	100	100	No	205032	0.0904	517-C04	545	100	100	Yes	203601	0.1356
514-G02Q	543	50	50	No	205490	0.105	517-C05	545	50	50	Yes	203618	0.1597
514-G03	543	100	100	No	205056	0.0992	517-C06	545	50	50	Yes	203625	0.168
514-G03Q	543	50	50	No	205483	0.111	517-C07	545	50	50	Yes	203687	0.3177
514-G04	543	100	100	No	205070	0.0975	517-C08	545	50	50	Yes	203694	0.3398
514-G04Q	543	25	25	No	205476	0.126	517-C09	545	50	50	Yes	203724	0.3841
514-G05	543	100	100	No	205087	0.1102	517-C10	545	25	25	Yes	203748	0.582
514-G05Q	543	25	25	No	205469	0.138	517-G02	545	100	100	Yes	203762	0.1046
514-G06	543	100	100	No	205094	0.116	517-G03	545	100	100	Yes	203779	0.1145
514-G06Q	543	25	25	No	205513	0.156	517-G04	545	100	100	Yes	203786	0.1548
514-G07	543	100	100	No	205117	0.1325	517-G05	545	100	100	Yes	203830	0.0829
514-G07Q	543	10	10	No	205452	0.165	517-G06	545	50	50	Yes	203847	0.2936
515-10GPK2	544	<b>10</b>	10	Yes	261106	0.9742	517-G07	545	50	50	Yes	203861	0.3506
515-2CPK2	544	<b>10</b>	10	Yes	261229	0.1573	517-G08	545	50	50	Yes	203878	0.3891
515-2GPK2	544	<b>10</b>	10	Yes	261021	0.1613	517-G09	545	25	25	Yes	203885	0.4334
515-3CPK2	544	<b>10</b>	10	Yes	261236	0.1593	517-G10	545	25	25	Yes	203908	0.6332

Item No	Page No	Min Qty	Case Qty	UPC Bar-Coded	UPC 6-Digit	Weight (lbs.)	Item No	Page No	Min Qty	Case Qty	UPC Bar-Coded	UPC 6-Digit	Weight (lbs.)
517-I062PK2	545	1	25	Yes	204363	0.154	521-820	517	50	50	No	206848	0.256
517-I087PK2	545	1	25	Yes	204370	0.194	521-851	517	50	50	No	206855	0.5005
517-I112PK2	545	1	20	Yes	204394	0.23	521-851PK	517	<b>25</b>	25	Yes	207029	0.514
517-I137PK2	545	1	20	Yes	204493	0.3263	521-852	517	50	50	No	206862	0.6314
517-I162PK2	545	1	20	Yes	204509	0.3571	522-100B	526	1	10	No	201331	0.2431
517-I212PK2	545	1	10	Yes	204516	0.5247	522-100BPK2	526	1	10	Yes	266187	0.0482
520-09	208	250	250	No	101167	0.0882	522-101	526	<b>100</b>	100	No	201355	0.0089
520-19	529	<b>50</b>	50	No	206640	0.216	522-102	526	<b>100</b>	100	No	267603	0.0078
520-19C	529	<b>50</b>	50	No	206657	0.216	522-5500	526	<b>100</b>	100	No	201591	0.0317
520-19CPK	529	<b>25</b>	25	Yes	209061	0.2239	522-5500	535	<b>100</b>	100	No	201591	0.0317
520-19PK	529	<b>50</b>	50	Yes	209023	0.2285	522-5501	526	<b>100</b>	100	No	206923	0.0372
520-19T	529	50	50	No	206664	0.204	522-5501	535	<b>100</b>	100	No	206923	0.0372
520-19TC	529	50	50	No	206671	0.193	523-01	526	<b>10</b>	50	No	201614	0.0937
520-24	529	25	25	No	206688	0.292	523-1	526	50	50	No	201232	0.0601
520-419	529	50	50	No	206701	0.203	523-1	535	50	50	No	201232	0.0601
520-419T	529	50	50	No	206725	0.1792	523-16	525	<b>50</b>	50	No	266460	0.325
520-419TC	529	50	50	No	206732	0.18	523-1604	525	<b>50</b>	50	No	266446	0.3289
520-616	529	<b>50</b>	50	No	200853	0.4	523-1610	525	50	50	No	266477	0.3285
520-616PK	529	50	50	Yes	200853	0.4	523-1614	525	50	50	No	266361	0.3538
520-626	529	<b>50</b>	50	No	201317	0.52	523-1614Q	526	<b>25</b>	25	No	709301	0.314
520-626PK	529	<b>10</b>	10	Yes	201317	0.545	523-1620	525	<b>50</b>	50	No	266354	0.3586
520-E16	517	<b>100</b>	100	No	266736	0.1257	523-162001	525	1	1	No	266378	17.637
520-E24	517	<b>100</b>	100	No	266712	0.2425	523-1620PK1	525	<b>10</b>	10	Yes	266545	0.4428
520-EC2	517	<b>100</b>	1000	No	267283	0.0135	523-1624	525	<b>50</b>	50	No	266385	0.3819
520-EC3	517	<b>100</b>	1000	No	267290	0.0158	523-162401	525	1	1	No	266392	18.8503
521-110	534	25	25	No	201201	0.7125	523-1624Q	526	25	25	No	202789	0.4034
521-111	534	50	50	No	267795	0.3084	523-1630	525	50	50	No	266439	0.3874
521-112	534	50	50	No	267801	0.354	523-1634	525	50	50	No	266408	0.4119
521-113	534	50	50	No	267818	0.3572	523-1634Q	526	25	25	No	202796	0.376
521-118	517	<b>50</b>	50	No	206749	0.354	523-16DEQ	526	<b>25</b>	25	No	709219	0.288
521-118R	517	25	25	No	206756	0.3736	523-1B	535	<b>5</b>	50	No	201638	0.1637
521-126	517	50	50	No	206763	0.4134	523-1C	535	<b>5</b>	50	No	200532	0.154
521-210	501	<b>25</b>	25	Yes	206770	0.0738	523-1D	535	<b>5</b>	50	No	200556	0.134
521-210	502	<b>25</b>	25	Yes	206770	0.0738	523-1K52000	525	<b>10</b>	10	No	201645	0.5562
521-318	517	<b>50</b>	50	No	206787	0.628	523-24	525	<b>50</b>	50	No	201669	0.395
521-360	517	<b>50</b>	50	No	206794	0.738	523-2404	525	<b>50</b>	50	No	201676	0.4387
521-3725B	517	<b>100</b>	100	No	266552	0.2566	523-2414	525	50	50	No	201683	0.5637
521-557	543	25	25	No	265982	0.0556	523-2420	525	<b>50</b>	50	No	201690	0.48
521-558	543	<b>25</b>	25	No	206800	0.164	523-242001	525	1	1	No	201225	23.398
521-559	543	<b>25</b>	25	No	266163	0.1867	523-2424	525	<b>50</b>	50	No	201713	0.5002
521-6415	518	25	25	No	206817	0.36	523-242401	525	1	1	No	201218	24.56
521-6416	518	25	25	No	265852	0.3532	523-2424Q	526	25	25	No	202819	0.6101
521-723	533	25	25	Yes	266156	0.3694	523-2434	525	50	50	No	201737	0.523
521-723BB	533	25	25	No	201447	0.2227	523-2434Q	526	25	25	No	202826	0.5637
521-725	533	<b>5</b>	5	No	260888	0.806	523-2MS	535	50	50	No	267184	0.175
521-728	533	<b>5</b>	5	No	260840	0.788	523-2MS2	535	50	50	No	267191	0.2533
521-729	533	<b>5</b>	5	No	206947	0.78	523-2MS3	535	50	50	No	267207	0.3636
521-730	533	<b>5</b>	5	No	207036	0.77	523-2MS4	535	50	50	No	267214	0.3732
521-810	517	<b>50</b>	50	No	206831	0.388	523-31	490	<b>100</b>	1000	No	201744	0.0283
521-810PK	517	<b>50</b>	50	Yes	220202	0.3972	523-32	490	<b>100</b>	1000	No	201751	0.0403

Supply

Drainage

Support

Specialties

Appendix

# Numerical Index

Supply

Drainage

Support

Specialties

Appendix

Item No	Page No	Min Qty	Case Qty	UPC Bar-Coded	UPC 6-Digit	Weight (lbs.)	Item No	Page No	Min Qty	Case Qty	UPC Bar-Coded	UPC 6-Digit	Weight (lbs.)
523-33	490	<b>50</b>	500	No	201768	0.0478	<b>525-1622PK1</b>	515	10	10	Yes	266651	0.5293
523-34	490	<b>50</b>	500	No	201775	0.051	<b>525-1622V</b>	516	25	25	No	200501	0.664
523-3MS2C	535	<b>25</b>	100	No	205353	0.0549	<b>525-1623</b>	515	<b>25</b>	25	No	267092	0.5372
523-3MS2G	535	<b>25</b>	100	No	205544	0.0375	<b>525-1624</b>	515	<b>25</b>	25	No	267627	0.6085
523-3MS3C	535	<b>25</b>	100	No	205506	0.0375	<b>525-162PB</b>	515	<b>25</b>	25	Yes	267320	0.68
523-3MS3G	535	<b>25</b>	100	No	205551	0.043	<b>525-162PBL</b>	515	<b>25</b>	25	No	267917	0.7264
523-3MS4C	535	<b>10</b>	50	No	205537	0.1	<b>525-162PBPk</b>	515	10	10	Yes	200884	0.735
523-3MS4G	535	<b>10</b>	50	No	205568	0.113	<b>525-162PBV</b>	516	25	25	No	200518	0.831
523-3MS5C	535	<b>10</b>	50	No	205582	0.115	<b>525-16T</b>	516	<b>100</b>	100	No	267139	0.1925
523-3MS5G	535	<b>10</b>	50	No	205599	0.12	<b>525-16WLB</b>	516	<b>25</b>	25	No	267696	0.5449
523-3MS6C	535	<b>10</b>	50	No	205605	0.138	<b>525-2002PK2</b>	529	50	50	Yes	200846	0.2865
523-3MS6G	535	<b>10</b>	10	No	205612	0.165	<b>525-20B</b>	516	<b>100</b>	100	No	267047	0.1966
523-3MS7C	535	<b>10</b>	50	No	205629	0.161	<b>525-20B</b>	530	<b>100</b>	100	No	267047	0.1966
523-3MS7G	535	<b>10</b>	10	No	205575	0.18	<b>525-2412</b>	515	<b>25</b>	25	No	267108	0.6067
523-3MS8G	535	<b>10</b>	10	No	205636	0.23	<b>525-2413</b>	515	<b>25</b>	25	No	300515	0.6067
523-3MS9G	535	<b>10</b>	10	No	205650	0.285	<b>525-241PB</b>	515	<b>25</b>	25	No	267344	0.6976
523-3MSL	535	25	25	No	201621	0.7556	<b>525-241PBL</b>	515	<b>25</b>	25	No	267900	0.7275
523-3MSS	535	25	25	No	201652	0.45	<b>525-2422</b>	515	<b>25</b>	25	No	267115	0.6788
523-3MSS2	535	25	25	No	201874	0.508	<b>525-242PB</b>	515	<b>25</b>	25	No	267351	0.837
523-3MSS3	535	25	25	No	201898	0.532	<b>525-242PBL</b>	515	<b>25</b>	25	No	267894	1.3988
523-5500Q	526	<b>100</b>	100	No	203205	0.0276	<b>525-24T</b>	516	<b>100</b>	100	No	267146	0.2596
523-5501Q	526	100	100	No	319906	0.8818	<b>525-27B</b>	516	<b>100</b>	100	No	267054	0.2717
523-712W	526	<b>10</b>	50	No	203298	0.038	<b>525-27B</b>	530	<b>100</b>	100	No	267054	0.2717
523-734W	526	<b>10</b>	50	No	203304	0.1113	<b>525-32C</b>	484	<b>1</b>	25	Yes	713162	-
523-DEQ	526	1	25	Yes	202772	0.02	<b>525-33</b>	484	1	25	No	200976	0.2348
523-DEQ50	526	<b>1</b>	4	No	206015	0.325	<b>525-33C</b>	484	<b>1</b>	25	Yes	713179	-
523F2424	525	50	50	No	208071	0.6259	<b>525-34</b>	484	1	25	No	200983	0.2548
523F5500	526	<b>100</b>	100	No	265999	0.049	<b>525-34C</b>	484	<b>1</b>	25	Yes	713186	-
523F5500	535	<b>100</b>	100	No	265999	0.049	<b>525-35</b>	484	1	25	No	326072	0.2386
523-VLK1	525	25	25	Yes	205162	0.552	<b>525-35C</b>	484	<b>1</b>	25	No	713193	-
523-VLK2	525	25	25	Yes	205179	0.57	<b>525-6920</b>	529	<b>100</b>	100	No	713483	0.244
524-10	505	<b>50</b>	50	No	201782	0.6	<b>525-6920</b>	530	<b>100</b>	100	No	713483	0.244
524-100	505	<b>5</b>	5	No	201799	5.588	<b>525-6926</b>	529	<b>100</b>	100	No	713490	0.2495
524-1022PK2	505	<b>10</b>	50	Yes	203137	0.616	<b>525-6926</b>	530	<b>100</b>	100	No	713490	0.2495
524-10CPK2	505	<b>10</b>	10	Yes	203168	0.3692	<b>525-B2</b>	516	<b>50</b>	50	No	267153	0.0714
524-10PK	505	50	50	Yes	203038	0.5628	<b>525-B2M1</b>	515	25	25	Yes	205155	0.232
524-10PK2	505	<b>10</b>	10	Yes	203021	0.5107	<b>525-B2S</b>	515	1	50	Yes	200952	0.1015
524-50	505	<b>10</b>	10	No	201829	2.4383	<b>525-B3</b>	516	<b>50</b>	50	No	267160	0.0732
524-50PK3	505	<b>1</b>	10	Yes	203069	2.505	<b>525-B3S</b>	515	1	50	Yes	201096	0.101
525-02	529	<b>100</b>	1000	No	314741	0.0128	<b>525-B4</b>	516	<b>50</b>	50	No	267658	0.1197
525-02G	529	<b>100</b>	1000	No	324016	0.0156	<b>525-P2</b>	516	<b>50</b>	50	No	267375	0.0613
525-03	529	<b>100</b>	1000	No	314758	0.0146	<b>525-P22</b>	516	<b>50</b>	50	No	268358	0.1532
525-1612	515	<b>25</b>	25	No	267078	0.4708	<b>525-P2M</b>	516	<b>25</b>	100	No	268334	0.1379
525-1613	515	<b>25</b>	25	No	300010	0.4738	<b>525-P2M1</b>	515	25	25	Yes	268341	0.32
525-1614	515	<b>25</b>	25	No	267610	0.478	<b>525-P2PK</b>	516	<b>10</b>	10	Yes	200891	0.0536
525-161PB	515	<b>25</b>	25	Yes	267313	0.52	<b>525-WLB</b>	516	<b>50</b>	50	No	267702	0.1765
525-161PBL	515	<b>25</b>	25	No	267924	0.5704	<b>528-10</b>	505	<b>50</b>	50	No	201836	0.3398
525-161PBPk	515	10	10	Yes	200877	0.5728	<b>528-100</b>	505	<b>5</b>	5	No	201843	3.326
525-1622	515	<b>25</b>	25	No	267085	0.5372	<b>528-10PK</b>	505	<b>50</b>	50	Yes	203090	0.304
525-1622L	515	<b>25</b>	25	No	202314	0.5626	<b>528-10PK2</b>	505	<b>10</b>	10	Yes	203083	0.34



Item No	Page No	Min Qty	Case Qty	UPC Bar-Coded	UPC 6-Digit	Weight (lbs.)	Item No	Page No	Min Qty	Case Qty	UPC Bar-Coded	UPC 6-Digit	Weight (lbs.)
528-25PK2	505	<b>1</b>	12	Yes	266972	0.8312	550-11E	485	100	100	Yes	266217	0.0621
528-50	505	<b>10</b>	10	No	201867	1.7053	550-11PK2	485	<b>1</b>	10	Yes	200440	0.1577
530-163	549	<b>100</b>	100	No	265821	0.074	550-11Q	485	<b>100</b>	100	No	202239	0.0379
530-1635	549	<b>100</b>	100	No	201881	0.2661	550-11QPK2	485	<b>1</b>	10	Yes	266194	0.3521
530-163PK	549	<b>100</b>	100	Yes	265821	0.0675	550-12	485	<b>1</b>	<b>1</b>	No	202246	2.9321
530-166	549	<b>100</b>	100	No	201904	0.152	550-210	536	<b>25</b>	250	No	205858	0.0344
530-166PK	549	<b>100</b>	100	Yes	201003	0.152	550-2111	485	<b>50</b>	50	Yes	205841	0.097
530-166PK3	549	<b>1</b>	<b>1</b>	Yes	202505	14.25	550-2111	536	<b>50</b>	50	Yes	205841	0.097
530-169	549	<b>50</b>	50	No	207746	0.204	550-2111PK2	536	<b>10</b>	10	Yes	205841	0.12
530-6M	549	<b>100</b>	100	No	266149	0.1531	550-2111PK3	485	<b>1</b>	<b>1</b>	No	205919	4.6
533-1	549	<b>25</b>	25	No	201942	0.578	550-2111PK3	536	<b>1</b>	<b>1</b>	No	205919	4.6
533-2	549	25	25	No	201959	0.7682	550-2111Q	537	<b>1</b>	50	Yes	205834	0.125
533-3	549	10	10	No	201966	0.8685	550-2111QPK2	537	<b>10</b>	10	Yes	205834	0.135
535-14	509	<b>25</b>	25	No	201973	0.798	550-2112	485	<b>1</b>	25	Yes	205926	0.136
535-914	509	<b>25</b>	25	No	201997	0.59	550-2112	536	<b>1</b>	25	Yes	205926	0.136
535-926	509	<b>25</b>	25	No	202000	0.9659	550-2112Q	537	<b>1</b>	25	Yes	205865	0.194
535-9P	509	<b>50</b>	50	No	202017	0.0998	550-2113	536	<b>1</b>	25	Yes	205933	0.186
536-09	550	<b>50</b>	50	No	202024	0.22	550-2121	536	<b>50</b>	50	Yes	206305	0.118
536-12	550	<b>50</b>	50	No	202031	0.2974	550-2121PK3	536	<b>1</b>	<b>1</b>	No	206480	5.55
536-18	550	<b>50</b>	50	No	202048	0.428	550-2121Q	537	<b>1</b>	25	Yes	206312	0.162
536-35	549	<b>100</b>	100	No	202055	0.2263	550-2122	536	<b>1</b>	25	Yes	206329	0.164
536-36	549	<b>50</b>	50	No	266064	0.352	550-2122Q	537	<b>1</b>	25	Yes	206336	0.212
536-56E	549	<b>50</b>	50	No	200006	0.4933	550-214QPK2	537	<b>1</b>	10	Yes	206503	0.18
536-58	549	<b>50</b>	50	No	202062	0.7467	550-214QPK3	537	<b>1</b>	4	Yes	206497	0.6125
536-612	550	<b>25</b>	25	No	266071	1.0523	550-3131	536	50	50	Yes	724632	0.094
536-616	550	<b>25</b>	25	No	267177	1.6305	550-3131PK3	536	<b>1</b>	<b>1</b>	Yes	724649	-
536-68E	549	<b>50</b>	50	No	200037	0.7153	550-3132	536	25	25	Yes	724656	-
536-85	550	<b>50</b>	50	Yes	206275	0.7518	550-AMB	539	10	10	Yes	205377	0.5732
538-09	550	<b>50</b>	50	No	202086	0.194	550F11	485	<b>25</b>	100	Yes	200419	0.0476
538-09PK	550	<b>50</b>	50	Yes	206220	0.188	550F3111	537	25	25	Yes	724670	-
538-12	550	<b>50</b>	50	No	202093	0.252	550F3121	537	10	10	Yes	724687	0.165
538-18	550	<b>50</b>	50	No	202109	0.348	550F3121PK3	537	<b>1</b>	<b>1</b>	Yes	724700	-
539-18	550	<b>25</b>	25	No	202116	0.997	550F3131	537	10	10	Yes	724694	-
539-518	550	<b>25</b>	25	No	208088	1.432	550F3131PK3	537	<b>1</b>	<b>1</b>	Yes	724717	-
539-6	550	<b>50</b>	50	No	202123	0.392	550-FP2	521	<b>25</b>	25	No	266996	0.28
541-CB	543	25	25	No	201805	0.168	550-FP2S	521	<b>25</b>	25	No	267597	0.1962
541-CPK2	543	<b>20</b>	20	Yes	263636	0.2014	550-M2	521	<b>50</b>	50	No	202352	0.1013
541-GB	543	25	25	No	201850	0.173	550-M2PK	521	<b>10</b>	10	Yes	202352	0.1055
541-GPK2	543	<b>20</b>	20	Yes	263629	0.2114	550-M3	521	<b>25</b>	25	No	202369	0.23
542-PK2	543	<b>10</b>	10	Yes	264015	0.3973	550-M3PK	521	<b>10</b>	10	Yes	202369	0.2205
543-21	540	<b>8</b>	8	No	735256	0.542	550-MP2	521	<b>25</b>	25	No	202383	0.2048
543-21R	540	<b>8</b>	8	Yes	729361	0.88	550-MP2PK	521	<b>10</b>	10	Yes	208545	0.2299
549-712	502	<b>50</b>	50	No	202185	0.1293	550-MP3	521	<b>25</b>	25	No	266538	0.328
549-734	502	<b>25</b>	25	No	202192	0.1465	550-PB2	521	<b>50</b>	50	No	203175	0.0544
549-808	501	<b>6</b>	6	No	200044	0.4583	550-PB3	521	<b>50</b>	50	No	205346	0.162
549-809	501	<b>6</b>	6	No	267764	0.5417	550-PC2	521	<b>10</b>	10	No	205131	0.333
549-810	501	<b>6</b>	6	No	200051	0.7417	551-2	480	<b>100</b>	1000	No	202390	0.0131
549-811	501	<b>6</b>	6	No	200068	0.7167	551-2BKT	480	<b>1</b>	<b>1</b>	No	735300	17.605
550-02	486	<b>1</b>	10	Yes	203335	0.353	551-2C	480	<b>100</b>	1000	No	202413	0.0132
550-11	485	<b>100</b>	100	No	202215	0.0335	551-2PK2	480	<b>20</b>	20	Yes	200549	0.1542

Supply

Drainage

Support

Specialties

Appendix

# Numerical Index

Supply

Drainage

Support

Specialties

Appendix

Item No	Page No	Min Qty	Case Qty	UPC Bar-Coded	UPC 6-Digit	Weight (lbs.)	Item No	Page No	Min Qty	Case Qty	UPC Bar-Coded	UPC 6-Digit	Weight (lbs.)
551-3	480	<b>50</b>	500	No	265289	0.0206	553-9WZPK2	501	1	5	Yes	267856	0.67
551-3BKT	480	<b>1</b>	1	No	735317	16.2371	553-STRP	502	<b>50</b>	50	No	204554	0.074
551-3C	480	<b>50</b>	500	No	200310	0.0218	554-08	496	<b>100</b>	2500	No	202802	0.0033
551-3PK2	480	20	20	Yes	200587	0.2249	554-100	505	1	20	Yes	203281	1.2054
551-4	480	<b>25</b>	250	No	202475	0.0296	554-100W	505	1	20	Yes	266514	0.9125
551-4BKT	480	<b>1</b>	1	No	735249	13.682	554-10PK2	505	<b>10</b>	10	Yes	203229	0.16
551-4PK2	480	20	20	Yes	496775	0.3462	554-14	496	<b>100</b>	1000	No	265456	0.0056
551-P2	481	<b>100</b>	1000	No	265296	0.0172	554-14H	496	<b>100</b>	1000	No	200075	0.0126
551-P2PK3	481	1	10	Yes	200563	1.7452	554-21	496	<b>50</b>	500	No	202833	0.0286
551-P2Q	481	<b>25</b>	25	No	205940	0.022	554-25	505	<b>1</b>	20	Yes	203243	0.3625
551-P2S	481	<b>100</b>	1000	No	265449	0.0186	554-25W	505	<b>1</b>	20	Yes	266521	0.24
551-P3	481	<b>50</b>	500	No	265302	0.0228	554-36	496	<b>50</b>	250	No	202857	0.042
551-P3PK3	481	1	10	Yes	200600	1.1886	554-608	496	<b>500</b>	500	No	202864	0.0048
551-P3Q	481	<b>25</b>	25	No	205957	0.03	554-614	496	<b>100</b>	1000	No	202871	0.0076
551-P3S	481	<b>50</b>	500	No	200624	0.0222	555-1	479	<b>100</b>	1000	No	265319	0.0071
551-P4Q	481	<b>25</b>	25	No	205964	0.038	555-2	479	<b>100</b>	1000	No	265326	0.0097
551-P5Q	481	<b>25</b>	25	No	205988	0.042	555-23	480	<b>100</b>	1000	No	265357	0.0155
552-A2	481	<b>50</b>	50	No	267382	0.0234	555-23BKT	480	<b>1</b>	1	No	735324	16.5844
552-A3	481	<b>50</b>	50	No	267399	0.0273	555-23PK2	480	10	10	Yes	200921	0.186
552-B22	481	<b>50</b>	50	No	267405	0.0332	555-23PK3	480	1	10	Yes	205193	0.9434
552-B23	481	<b>50</b>	50	No	267412	0.0344	555-23S	480	<b>100</b>	1000	No	266330	0.0162
552-B33	481	<b>50</b>	50	No	267429	0.0345	555-2BKT	479	<b>1</b>	1	No	735331	23.2227
552-C22	481	<b>50</b>	50	No	267436	0.0319	555-3	479	<b>100</b>	1000	No	265333	0.0148
552-C23	481	<b>50</b>	50	No	267443	0.0332	555-3BKT	479	<b>1</b>	1	No	735263	18.111
552-C33	481	<b>50</b>	50	No	267450	0.0351	555-4	479	<b>50</b>	500	No	265340	0.0236
553-014	502	<b>100</b>	100	No	202987	0.208	555-4BKT	479	<b>1</b>	1	No	735270	15.99
553-014PK	502	25	25	Yes	202987	0.178	555-623	480	<b>100</b>	1000	No	203007	0.0135
553-026	502	<b>50</b>	50	No	204561	0.3221	555-623PK2	480	<b>10</b>	10	Yes	267863	0.166
553-22W	486	<b>50</b>	150	No	252005	0.0575	556-2	479	<b>100</b>	1000	No	206992	0.0094
553-23W	486	<b>50</b>	150	No	252012	0.0645	556-2BKT	479	<b>1</b>	1	No	735287	18.816
553-2W	486	<b>50</b>	50	Yes	252043	0.0341	556-2PK2	479	<b>10</b>	10	Yes	200747	0.0046
553-33W	486	<b>50</b>	150	No	252036	0.0655	556-2PK3	479	<b>1</b>	10	Yes	200761	0.9433
553-3W	486	<b>50</b>	50	Yes	252081	0.0354	556-2S	479	<b>100</b>	1000	No	203076	0.0117
553-4W	486	<b>50</b>	50	Yes	252128	0.0389	556-3	479	<b>100</b>	1000	No	206985	0.0145
553-5W	486	<b>50</b>	50	Yes	252449	0.0461	556-3BKT	479	<b>1</b>	1	No	735294	16.386
553-6W	501	<b>50</b>	50	Yes	252166	0.0844	556-3PK2	479	<b>10</b>	10	Yes	200785	0.178
553-6WM25	501	<b>10</b>	10	Yes	207753	2.155	556-3PK3	479	<b>1</b>	10	Yes	200808	1.5199
553-6WZ	501	<b>25</b>	100	No	205872	0.0955	556-3S	479	<b>100</b>	1000	No	203120	0.0155
553-6WZPK2	501	1	5	Yes	267825	0.4028	556-4	479	<b>50</b>	500	No	206954	0.0268
553-7W	501	<b>50</b>	50	Yes	252203	0.1028	556-4BKT	479	<b>1</b>	1	No	735232	14.5688
553-7WM25	501	<b>10</b>	10	Yes	207760	2.6211	556-4C	479	<b>50</b>	500	No	203151	0.0265
553-7WZ	501	<b>25</b>	100	No	205889	0.1115	556-4PK2	479	10	10	Yes	266989	0.289
553-7WZPK2	501	1	5	Yes	267832	0.52	556-4PK3	479	<b>1</b>	10	Yes	200822	1.3831
553-830W	501	<b>50</b>	50	Yes	252852	0.1447	556-5	479	<b>250</b>	250	No	203915	0.0359
553-8W	501	<b>50</b>	50	Yes	252241	0.1082	556-5S	479	<b>25</b>	100	No	204295	0.0362
553-8WM25	501	<b>10</b>	10	Yes	207777	2.515	557-2	482	<b>100</b>	1000	No	206893	0.0089
553-8WZ	501	<b>25</b>	100	No	205896	0.139	557-2PK2	482	10	10	Yes	201706	0.0714
553-8WZPK2	501	1	5	Yes	267849	0.61	557-2Q	482	<b>50</b>	50	No	203182	0.0331
553-9W	501	<b>25</b>	25	Yes	252289	0.1652	557-3	482	<b>100</b>	1000	No	203199	0.0115
553-9WZ	501	<b>25</b>	100	No	205902	0.153	557-3PK2	482	10	10	Yes	201720	0.0814

Item No	Page No	Min Qty	Case Qty	UPC Bar-Coded	UPC 6-Digit	Weight (lbs.)	Item No	Page No	Min Qty	Case Qty	UPC Bar-Coded	UPC 6-Digit	Weight (lbs.)
557-3Q	482	<b>50</b>	50	No	318978	0.0041	<b>559F2</b>	482	<b>100</b>	1000	No	203571	0.0193
557-4	482	<b>50</b>	500	No	203212	0.0156	<b>559F3</b>	482	<b>50</b>	500	No	203403	0.0253
557-4PK2	482	10	10	Yes	200150	0.0993	<b>559F4</b>	482	<b>50</b>	500	No	203397	0.0364
557-4Q	482	<b>25</b>	25	No	318954	0.0407	<b>559F5</b>	482	10	10	No	200754	0.0746
557-5	482	<b>25</b>	250	No	206978	0.0256	<b>559F6</b>	482	10	10	No	200778	0.0836
557-5PK2	482	10	10	Yes	200167	0.1495	<b>559F7</b>	482	10	10	No	200792	0.0905
557-5Q	482	<b>25</b>	25	No	318961	0.0587	<b>570</b>	534	24	24	No	203632	0.304
557-6	482	<b>25</b>	250	No	203236	0.0307	<b>570-10</b>	534	24	24	Yes	203649	0.4738
557-6PK2	482	10	10	Yes	200181	0.2035	<b>570-20</b>	534	<b>24</b>	24	Yes	203656	0.5737
557-7	482	<b>25</b>	250	No	202901	0.0428	<b>570-22</b>	534	24	24	Yes	203380	0.5697
557-7PK2	482	10	10	Yes	200204	0.2486	<b>570-24</b>	534	24	24	Yes	203670	0.566
557F2	483	<b>100</b>	1000	No	203250	0.0163	<b>570-53</b>	534	50	1000	Yes	203373	0.036
557F3	483	<b>50</b>	500	No	203267	0.0212	<b>570-58</b>	534	50	50	Yes	203663	0.063
557F4	483	<b>50</b>	500	No	203274	0.0291	<b>572</b>	534	24	24	No	265869	0.3491
557F5	483	10	10	No	200716	0.1083	<b>572-20</b>	534	24	24	Yes	203793	0.6133
557F6	483	10	10	No	200723	0.1083	<b>572-22</b>	534	24	24	Yes	203809	0.6093
557F7	483	10	10	No	200730	0.133	<b>572-24</b>	534	24	24	Yes	203816	0.6333
558-2	483	<b>50</b>	500	No	265418	0.021	<b>572-53</b>	534	50	250	Yes	208132	0.0369
558-23	484	<b>100</b>	1000	No	266606	0.009	<b>574-710</b>	496	10	10	No	202888	0.1605
558-23B	484	<b>100</b>	1000	No	267788	0.0092	<b>574-710</b>	536	10	10	No	202888	0.1605
558-2PK2	483	10	10	Yes	201522	0.1263	<b>574-713</b>	496	10	10	No	202895	0.2085
558-3	483	<b>50</b>	500	No	265425	0.0164	<b>574-713</b>	536	10	10	No	202895	0.2085
558-3PK2	483	10	10	Yes	201560	0.1033	<b>574-72</b>	496	50	50	No	506658	0.1081
558-4	483	<b>25</b>	250	No	265432	0.0163	<b>574-72</b>	534	50	50	No	506658	0.1081
558-E1	483	<b>50</b>	500	No	203366	0.0235	<b>574-72</b>	536	50	50	No	506658	0.1081
558-E2	483	<b>50</b>	500	No	265388	0.0193	<b>574-74</b>	496	50	50	No	200686	0.0905
558-E2PK2	483	10	10	Yes	201300	0.1257	<b>574-74</b>	534	50	50	No	200686	0.0905
558-E3	483	<b>50</b>	500	No	265395	0.0174	<b>574-74</b>	536	50	50	No	200686	0.0905
558-E3PK2	483	10	10	Yes	201348	0.1167	<b>574-75</b>	496	50	50	No	506665	0.1041
558-E4	483	<b>25</b>	250	No	265401	0.0163	<b>574-75</b>	534	50	50	No	506665	0.1041
558-E4PK2	483	10	10	Yes	201379	0.0929	<b>574-75</b>	536	50	50	No	506665	0.1041
558-M23	483	<b>100</b>	1000	No	201607	0.0072	<b>574-77</b>	496	50	50	No	506641	0.1299
558-M23H	483	<b>100</b>	1000	No	201980	0.0072	<b>574-77</b>	534	50	50	No	506641	0.1299
558-M23PK2	483	10	10	Yes	201508	0.055	<b>574-77</b>	536	50	50	No	506641	0.1299
558-M23R	484	<b>100</b>	1000	No	201928	0.0072	<b>575-100Q</b>	538	1	12	No	268365	2.0704
558-M4	483	<b>25</b>	250	No	203441	0.0062	<b>575-101Q</b>	538	<b>1</b>	10	No	203359	1.772
558-M4H	483	<b>50</b>	1000	No	266798	0.0051	<b>575-102Q</b>	538	<b>1</b>	10	No	203496	4.1
558-M4R	484	<b>25</b>	250	No	203458	0.0063	<b>575-510Q</b>	538	25	25	No	200815	0.0544
559-2	482	<b>100</b>	1000	No	265364	0.0105	<b>575-511Q</b>	538	25	25	No	200839	0.0938
559-2PK2	482	10	10	Yes	201102	0.0779	<b>575-512Q</b>	538	25	25	No	200860	0.2016
559-3	482	<b>50</b>	1000	No	203311	0.0136	<b>590-10</b>	495	1	10	Yes	503022	1.0693
559-3PK2	482	10	10	Yes	201140	0.0914	<b>590-4411</b>	495	1	5	Yes	267931	1.63
559-4	482	<b>50</b>	500	No	200235	0.0191	<b>590-4411</b>	546	1	5	Yes	267931	1.63
559-4PK2	482	10	10	Yes	265371	0.1235	<b>590-4411-3</b>	495	1	5	Yes	200136	1.894
559-5	482	<b>25</b>	250	No	200242	0.0322	<b>590-4411-3</b>	546	1	5	Yes	200136	1.894
559-5PK2	482	10	10	Yes	203540	0.177	<b>590-4412</b>	495	1	5	Yes	267948	1.72
559-6	482	<b>25</b>	250	No	200280	0.037	<b>590-4412</b>	546	1	5	Yes	267948	1.72
559-6PK2	482	10	10	Yes	203533	0.2146	<b>590-4413</b>	495	1	5	Yes	267955	1.54
559-7	482	<b>25</b>	250	No	200303	0.0484	<b>590-4413</b>	546	1	5	Yes	267955	1.54
559-7PK2	482	10	10	Yes	203427	0.145	<b>590-4421</b>	495	1	5	Yes	267962	1.91

Supply

Drainage

Support

Specialties

Appendix

# Numerical Index

Supply

Drainage

Support

Specialties

Appendix

Item No	Page No	Min Qty	Case Qty	UPC Bar-Coded	UPC 6-Digit	Weight (lbs.)	Item No	Page No	Min Qty	Case Qty	UPC Bar-Coded	UPC 6-Digit	Weight (lbs.)
590-4421	546	1	5	Yes	267962	1.91	<b>608-L2308</b>	116	25	25	No	400604	0.8608
590-4423	495	1	5	Yes	267986	2.1	<b>608-L246</b>	113	50	50	No	400673	0.2028
590-4423	546	1	5	Yes	267986	2.1	<b>608-L248</b>	113	50	50	No	400680	0.2426
590-44ND1	495	1	12	Yes	267993	0.0904	<b>608-L2508</b>	116	25	25	No	400710	1.377
590-44ND1	546	1	12	Yes	267993	0.0904	<b>608-L2508E</b>	116	25	25	No	400727	1.4965
590-44ND2	495	1	12	Yes	268006	0.1124	<b>608-L2612</b>	113	50	50	No	400314	0.3975
590-44ND2	546	1	12	Yes	268006	0.1124	<b>608-L263A</b>	116	<b>50</b>	50	No	401243	0.1772
591-06B	495	1	10	Yes	266958	0.3216	<b>608-L2812</b>	113	50	50	No	400789	0.4415
591-06B	516	1	10	Yes	266958	0.3216	<b>608-L348</b>	113	50	50	No	400796	0.4315
591-081	495	1	10	No	266309	0.5313	<b>608-L4612</b>	113	25	25	No	400291	0.9742
591-081	516	1	10	No	266309	0.5313	<b>609-L2138</b>	113	50	50	No	400857	0.462
598-010	553	1	1	Yes	200617	14.645	<b>609-L246</b>	113	50	50	No	400864	0.2069
598-011	553	1	1	Yes	200648	14.305	<b>609-L246E</b>	114	25	25	No	400871	0.2985
598-012	553	1	1	Yes	200679	21.2	<b>609-L248</b>	113	50	50	No	400888	0.2426
598-0210	553	<b>10</b>	10	No	202949	0.2285	<b>609-L248E</b>	114	25	25	No	400895	0.3
598-0210PK1	553	1	25	Yes	204684	0.2392	<b>609-L2612</b>	113	50	50	No	400901	0.3962
598-0210PK2	553	1	25	Yes	204691	0.4246	<b>609-L263A</b>	116	50	50	No	400918	0.1932
598-0213	553	<b>10</b>	10	No	202963	0.2745	<b>609-L27</b>	116	50	50	No	400949	0.2152
598-0213PK1	553	1	25	Yes	204738	0.2858	<b>609-L2812</b>	113	50	50	No	400956	0.4409
598-0213PK2	553	1	25	Yes	204745	0.5196	<b>609-L348</b>	113	50	50	No	400970	0.4338
598-022	553	<b>10</b>	10	Yes	733474	1.33	<b>609-L4612</b>	113	25	25	No	401007	0.9674
598-023	553	<b>10</b>	10	Yes	733719	1.722	<b>609-L4812</b>	113	25	25	No	401014	1.0461
600-206PK	113	<b>10</b>	10	Yes	400567	0.1678	<b>612-108</b>	115	25	25	No	401021	0.4588
600-212PK	113	<b>10</b>	10	Yes	400628	0.3251	<b>612-2S</b>	496	<b>50</b>	500	No	207708	0.021
600-306PK	113	<b>10</b>	10	Yes	400765	0.2528	<b>612-2SPK2</b>	496	10	10	Yes	207791	0.115
600-312PK	113	<b>10</b>	10	Yes	400826	0.4951	<b>612-3S</b>	496	<b>25</b>	250	No	207715	0.0186
600Q206	135	<b>6</b>	6	Yes	201546	0.195	<b>612-3SPK2</b>	496	10	10	Yes	207807	0.105
600Q306	135	<b>6</b>	6	Yes	201577	0.2925	<b>612-4S</b>	496	<b>25</b>	250	No	207722	0.016
600QG406	135	<b>6</b>	6	Yes	415813	0.5417	<b>612-557</b>	115	25	25	No	401038	0.4011
601-G20CV	121	6	6	Yes	415646	0.6908	<b>612-57</b>	115	25	25	No	464101	0.3168
601-G21CV	121	6	6	Yes	415660	0.6858	<b>612-87</b>	115	25	25	No	401045	0.3904
601-G30CV	121	6	6	Yes	415677	0.8567	<b>613-107</b>	114	50	50	No	401069	0.372
601Q20V	139	6	6	Yes	416568	0.5583	<b>613-137</b>	114	<b>50</b>	50	No	401076	0.4388
601Q30V	139	6	6	Yes	416520	0.6958	<b>613-139</b>	114	50	50	No	401083	0.4833
603Q2	46	15	15	Yes	407917	0.03	<b>613-57</b>	114	<b>50</b>	50	No	401090	0.2576
603Q2	137	15	15	Yes	407917	0.03	<b>613-57M</b>	115	<b>50</b>	50	No	401113	0.3238
603Q3	46	15	15	Yes	407924	0.0433	<b>613-57PK</b>	114	<b>20</b>	20	Yes	401052	0.268
603Q3	137	15	15	Yes	407924	0.0433	<b>613-57X</b>	115	<b>50</b>	50	No	401120	0.33
603Q4	46	15	15	Yes	407931	0.05	<b>613-57Y</b>	115	<b>50</b>	50	No	401137	0.3111
603Q4	137	15	15	Yes	407931	0.05	<b>613-67</b>	114	<b>50</b>	50	No	401144	0.2794
605QG2	135	<b>12</b>	12	Yes	415820	0.0879	<b>613-67F</b>	115	<b>50</b>	50	No	498397	0.3716
605QG3	135	<b>6</b>	6	Yes	415837	0.1583	<b>613-67M</b>	115	<b>50</b>	50	No	401151	0.3496
605QG4	135	<b>6</b>	6	Yes	415844	0.2342	<b>613-67X</b>	115	<b>50</b>	50	No	401168	0.36
605QG5	135	<b>3</b>	3	Yes	415851	0.5417	<b>613-67Y</b>	115	<b>50</b>	50	No	401175	0.3411
605QG6	135	<b>3</b>	3	Yes	415868	0.8517	<b>613-87</b>	114	<b>50</b>	50	No	401182	0.3252
605QG7	135	<b>3</b>	3	Yes	415875	1.2183	<b>613-87E</b>	114	<b>25</b>	25	No	401199	0.4003
608-D288E	114	25	25	No	400284	0.5812	<b>613-87M</b>	115	50	50	No	401205	0.3896
608-L2138	113	50	50	No	400574	0.4614	<b>613-87X</b>	115	<b>50</b>	50	No	401212	0.3987
608-L2187	113	50	50	No	400581	0.5506	<b>613-87Y</b>	115	<b>50</b>	50	No	401229	0.3869
608-L2277	113	50	50	No	400598	0.7503	<b>613-887L</b>	114	25	25	No	403537	0.5148

Item No	Page No	Min Qty	Case Qty	UPC Bar-Coded	UPC 6-Digit	Weight (lbs.)	Item No	Page No	Min Qty	Case Qty	UPC Bar-Coded	UPC 6-Digit	Weight (lbs.)
613-887R	114	25	25	No	403544	0.5148	624-L15	115	30	30	No	401847	0.8271
614-2	111	<b>50</b>	500	No	401526	0.0338	624-L18	115	30	30	No	401854	0.9676
614-3	111	<b>50</b>	500	No	401250	0.0395	630-C2412	93	<b>50</b>	50	No	401960	0.362
614-4	111	<b>25</b>	250	No	401267	0.0604	630-C248	93	<b>50</b>	50	No	401977	0.2686
614-8L	116	<b>50</b>	50	No	401281	0.2481	630-C248E	93	<b>25</b>	25	No	401984	0.3359
615-213	111	<b>10</b>	10	No	401298	0.2925	630-C248PK	93	<b>10</b>	10	Yes	490735	0.2937
615-233	111	<b>10</b>	10	No	401311	0.309	630-C287	93	<b>50</b>	50	No	401991	0.3454
615-313	111	<b>10</b>	10	No	495112	0.3958	630-C348	93	<b>50</b>	50	No	401618	0.7196
615-333	111	<b>10</b>	10	No	495129	0.4619	630-C3612	93	<b>25</b>	25	No	406026	0.7036
615-C2113	92	<b>25</b>	25	No	495358	0.566	630-C41016	93	<b>25</b>	25	No	418364	1.416
615-C2113	111	<b>25</b>	25	No	495358	0.566	630-C41110	93	<b>25</b>	25	No	400338	1.1968
615-C215	92	<b>10</b>	10	No	499295	0.314	630-C41110E	93	<b>10</b>	10	No	407481	1.215
615-C215	111	<b>10</b>	10	No	499295	0.314	630-C9248	102	<b>50</b>	50	No	402585	0.291
615W216	62	<b>25</b>	25	No	102423	0.3444	630-C93612	102	<b>25</b>	25	No	410122	0.66
615W216	111	<b>25</b>	25	No	102423	0.3444	630-C941012	102	<b>25</b>	25	No	410252	1.182
616-02BM	640	<b>1</b>	25	Yes	715579	0.13	630Q248	138	<b>20</b>	20	Yes	409355	0.3157
616-02C	640	25	25	Yes	506894	0.1147	630Q248E	138	<b>10</b>	10	Yes	421814	0.299
616-02RB	640	1	25	Yes	403551	0.1113	630Q368	138	<b>10</b>	10	Yes	410740	0.5735
616-02SN	640	1	25	Yes	506931	0.1113	630Q4910E	138	<b>10</b>	10	Yes	417756	1.095
616-15	117	25	25	No	401359	0.1567	630VG248	81	<b>25</b>	25	No	416872	0.3773
616-2	111	<b>50</b>	50	No	401366	0.389	630VG248E	81	<b>25</b>	25	No	413314	0.3773
616-2E3	111	<b>50</b>	50	No	419101	0.2691	630WG2138	63	<b>50</b>	50	No	406712	0.5504
616-2PK2	111	<b>10</b>	10	Yes	401625	0.4397	630WG2412	63	<b>50</b>	50	No	412898	0.4056
616-3E3	111	<b>25</b>	25	No	444547	0.37	630WG248	63	<b>50</b>	50	No	404633	0.31
616-630	116	<b>50</b>	50	No	401380	0.8633	630WG248E	63	<b>25</b>	25	No	404640	0.3378
616-630X	116	<b>50</b>	50	No	401397	0.9339	630WG248EPK1	63	<b>10</b>	10	Yes	422279	0.4071
616-630Y	116	<b>50</b>	50	No	401403	0.915	630WG248PK1	63	<b>10</b>	10	Yes	422286	0.3506
616-648	116	<b>12</b>	12	No	401410	1.2057	630WG348	63	<b>25</b>	25	No	404657	0.5698
616-650	116	<b>25</b>	25	No	401427	1.364	630WG348E	63	<b>25</b>	25	No	404664	0.6224
616-650X	116	<b>25</b>	25	No	401434	1.67	630WG4612	63	<b>25</b>	25	No	406705	1.1985
616-650Y	116	<b>25</b>	25	No	401441	1.6511	630WG4612E	63	<b>10</b>	10	No	406699	1.2885
616-CG2E3	92	<b>50</b>	50	No	412355	0.1619	630WGD288E	63	<b>25</b>	25	No	406682	0.6452
616X2PX	23	<b>50</b>	50	No	482969	0.4435	630X146	26	50	50	No	402035	0.2014
622-L03	115	100	100	No	410054	0.0703	630X148	26	50	50	No	400345	0.2426
622-L06	115	<b>100</b>	100	No	401489	0.1331	630X148E	26	25	25	No	400369	0.3045
622-L06PK	115	<b>20</b>	20	Yes	400079	0.1425	630X2138	26	50	50	No	403445	0.4601
622-L08	115	<b>100</b>	100	No	401496	0.1767	630X2412	26	50	50	No	400376	0.3398
622-L08PK	115	<b>10</b>	10	Yes	703491	0.183	630X2412E	26	<b>25</b>	25	No	441706	0.3843
622-L09CF	113	25	25	No	401533	0.2856	630X246	26	<b>50</b>	50	No	403438	0.2014
622-L10	115	100	100	No	401540	0.2203	630X246E	26	<b>25</b>	25	No	402097	0.2606
622-L12	115	<b>100</b>	100	No	401557	0.2653	630X248	26	<b>50</b>	50	No	402110	0.2426
622-L12PK	115	<b>10</b>	10	Yes	711694	0.2911	630X248E	26	<b>25</b>	25	No	495266	0.3018
622-L15	115	100	100	No	401564	0.3305	630X248EPK	26	<b>20</b>	20	Yes	480965	0.2981
622-L24E	115	20	20	No	401601	0.6053	630X248PK	26	<b>6</b>	6	Yes	480941	0.2504
623-L06	115	50	50	No	401700	0.2203	630X3136	26	50	50	No	402134	0.666
623-L08	115	50	50	No	401717	0.2956	630X3412	26	50	50	No	400352	0.5745
623-L12	115	50	50	No	401724	0.4503	630X348	26	<b>50</b>	50	No	402158	0.4338
623-L18	115	50	50	No	401755	0.6636	630X348E	26	<b>25</b>	25	No	403339	0.4942
624-L08	115	30	30	No	401809	0.4306	630X4612	26	25	25	No	410184	0.8818
624-L12	115	30	30	No	401823	0.6557	630X468	26	25	25	No	410177	0.6376

Supply

Drainage

Support

Specialties

Appendix

# Numerical Index

Supply

Drainage

Support

Specialties

Appendix

Item No	Page No	Min Qty	Case Qty	UPC Bar-Coded	UPC 6-Digit	Weight (lbs.)	Item No	Page No	Min Qty	Case Qty	UPC Bar-Coded	UPC 6-Digit	Weight (lbs.)
630X468E	26	10	10	No	441713	0.765	<b>632X283</b>	28	50	50	No	482419	0.2196
630XD288	27	25	25	No	487117	0.5537	<b>632X332</b>	24	<b>25</b>	250	No	402523	0.1011
631-33	117	1	25	No	407641	0.322	<b>632X335</b>	24	<b>25</b>	250	No	402547	0.109
631-33F	117	<b>25</b>	25	No	403315	0.2633	<b>632X458</b>	28	<b>25</b>	25	No	499820	0.6376
631-C307	94	<b>25</b>	25	No	402196	0.4578	<b>632XG222M</b>	22	<b>50</b>	50	No	404497	0.086
631-CG307FP	94	<b>10</b>	10	No	411389	1.205	<b>632XG332M</b>	22	<b>50</b>	50	No	404510	0.398
631-G305FP	117	<b>25</b>	25	No	413338	0.0276	<b>633-312</b>	118	<b>25</b>	25	No	402592	0.5587
631WG02	64	25	25	No	709455	0.352	<b>633-318</b>	118	<b>10</b>	10	No	402455	0.7842
631WG02FP	64	<b>12</b>	12	No	411785	1.06	<b>633-4312</b>	118	<b>25</b>	25	No	402653	0.6746
631X02	28	<b>25</b>	25	No	402257	0.3167	<b>633-C02</b>	91	<b>50</b>	50	No	402691	0.1983
631XG02FP	28	<b>12</b>	12	No	411808	1.115	<b>633-C02</b>	94	<b>50</b>	50	No	402691	0.1983
631XG3TM9	28	<b>25</b>	25	No	713681	0.794	<b>633-C02PK</b>	91	<b>10</b>	10	Yes	493101	0.2112
632-C263	93	<b>50</b>	50	No	402332	0.1892	<b>633-C02PK</b>	94	<b>10</b>	10	Yes	493101	0.2112
632-C263PK	93	<b>10</b>	10	Yes	491466	0.2015	<b>633-C09</b>	94	<b>25</b>	25	No	402707	0.4413
632-C263X	93	<b>50</b>	50	No	403278	0.2748	<b>633-C18</b>	94	<b>25</b>	25	No	402721	0.7803
632-C263XPK	93	<b>10</b>	10	Yes	499936	0.294	<b>633-C18PK</b>	94	<b>10</b>	10	Yes	494467	0.8886
632-C263YPK	93	<b>10</b>	10	Yes	499943	0.2751	<b>633-C24</b>	94	<b>25</b>	25	No	402776	0.9744
632-C283	93	<b>50</b>	50	No	402530	0.248	<b>633-C418</b>	94	<b>25</b>	25	No	402806	0.8962
632PX222M	53	<b>1</b>	10	No	438270	0.64	<b>633-C4403</b>	91	<b>20</b>	20	No	402868	0.4033
632PX232M	53	<b>1</b>	10	No	438904	0.725	<b>633-CG18FP</b>	94	<b>10</b>	10	No	411419	1.382
632PX332M	53	<b>1</b>	10	No	438973	0.835	<b>633-CG18FPT</b>	94	<b>10</b>	10	No	411426	1.695
632Q263	138	<b>20</b>	20	Yes	409362	0.215	<b>633-CG18FRV</b>	94	<b>10</b>	10	No	415554	1.6
632Q263X	138	<b>20</b>	20	Yes	409379	0.3118	<b>633-CG18HRV</b>	94	<b>10</b>	10	No	723284	15.7
632Q263Y	138	<b>20</b>	20	Yes	409386	0.2922	<b>633-CG24FP</b>	94	<b>10</b>	10	No	411433	1.558
632QG222F	136	<b>6</b>	6	Yes	415882	0.16	<b>633-CG418FP</b>	94	<b>10</b>	10	No	411440	1.5305
632QG222M	136	<b>6</b>	6	Yes	415899	0.193	<b>633-G312FP</b>	118	<b>10</b>	10	No	411709	1.2535
632QK000M	722	<b>5</b>	60	Yes	681003	-	<b>633-G318FP</b>	118	<b>10</b>	10	No	412904	1.7083
632QK002M	722	<b>5</b>	60	Yes	681010	-	<b>633-G3TC06</b>	95	<b>10</b>	10	No	422620	0.55
632QK110M	722	<b>5</b>	60	Yes	437228	-	<b>633-G3TM11</b>	119	<b>25</b>	25	No	411464	0.7266
632QK111M	722	<b>5</b>	60	Yes	681034	-	<b>633-G3TM15</b>	119	<b>25</b>	25	No	411518	0.8714
632QK221M	722	<b>5</b>	60	Yes	681041	-	<b>633-G3TM18FP</b>	119	<b>1</b>	25	No	407658	1.496
632QK222M	722	<b>5</b>	60	Yes	681058	-	<b>633-G3TM18FPF</b>	119	<b>1</b>	25	No	407665	1.522
632VG273	81	<b>50</b>	50	No	416940	0.2502	<b>633-G4TM11</b>	119	<b>25</b>	25	No	412812	0.852
632W273X	64	<b>50</b>	50	No	402387	0.3342	<b>633-G4TM15</b>	119	<b>25</b>	25	No	411877	1.1371
632WG222M	61	<b>50</b>	50	No	409416	0.259	<b>633Q03</b>	136	<b>12</b>	12	Yes	410986	0.218
632WG222MPK2	61	<b>10</b>	10	Yes	418913	0.5285	<b>633Q06FP</b>	138	<b>10</b>	10	Yes	410825	1.1254
632WG263	64	<b>50</b>	50	No	406743	0.2513	<b>633Q18</b>	138	<b>10</b>	10	Yes	410832	0.8103
632WG263Y	64	<b>50</b>	50	No	406736	0.2902	<b>633Q18FP</b>	138	<b>10</b>	10	Yes	410849	1.4
632WG332	62	<b>25</b>	25	No	409423	0.235	<b>633VG18</b>	82	<b>10</b>	10	Yes	411846	0.7756
632WG335	62	<b>25</b>	25	No	409430	0.163	<b>633VG18FP</b>	82	<b>10</b>	10	No	411815	1.5446
632WP222M	76	<b>25</b>	375	No	423702	0.0224	<b>633WG18</b>	65	<b>25</b>	25	No	406750	0.8503
632X222	24	<b>100</b>	1000	No	402448	0.046	<b>633WG18FP</b>	65	<b>10</b>	10	No	411839	1.63
632X225	24	<b>100</b>	1000	No	402462	0.0502	<b>633WG18FPT</b>	65	<b>10</b>	10	No	416612	1.66
632X232	24	<b>50</b>	250	No	402479	0.1049	<b>633WG18FRV</b>	65	<b>10</b>	10	No	713605	1.6
632X235	24	<b>25</b>	250	No	499646	0.1112	<b>633WG18HRV</b>	65	<b>10</b>	10	No	723260	1.585
632X243	28	<b>50</b>	50	No	402486	0.1291	<b>633WG18PK1</b>	65	<b>10</b>	10	Yes	406750	0.89
632X243PK	28	<b>20</b>	20	Yes	481467	0.1564	<b>633WG18WRV</b>	65	<b>10</b>	10	No	723277	-
632X263	28	50	50	No	402493	0.1877	<b>633WG306FP</b>	65	<b>10</b>	10	No	433220	0.855
632X263X	28	<b>50</b>	50	No	402509	0.2583	<b>633X02</b>	29	<b>25</b>	25	No	495433	0.1599
632X263Y	28	<b>50</b>	50	No	402516	0.2394	<b>633X18</b>	29	<b>25</b>	25	No	402882	0.7534

Item No	Page No	Min Qty	Case Qty	UPC Bar-Coded	UPC 6-Digit	Weight (lbs.)	Item No	Page No	Min Qty	Case Qty	UPC Bar-Coded	UPC 6-Digit	Weight (lbs.)
633X18PK	29	<b>25</b>	25	Yes	484468	0.7364	637WP25	76	<b>25</b>	375	No	423726	0.0334
633XG18FP	29	<b>10</b>	10	Yes	412867	1.5219	637X20	25	<b>50</b>	500	No	481542	0.0405
633XG18FPT	29	<b>10</b>	10	No	412942	1.6675	637X20PK2	25	<b>10</b>	10	Yes	481528	0.1069
633XG18FRV	29	<b>10</b>	10	No	416773	2.215	637X235	23	<b>50</b>	50	No	403254	0.1816
633XG18HRV	29	<b>10</b>	10	No	723291	1.555	637X25	25	<b>50</b>	50	No	481580	0.0606
633XG18XRV	29	<b>10</b>	10	No	723307	15.1	637X335	23	<b>25</b>	25	No	487902	0.1868
633XG3TF6	30	<b>10</b>	10	No	714015	0.645	637X410	24	<b>50</b>	500	No	403285	0.0531
633XG3TM6	30	<b>25</b>	25	No	713698	0.478	637X413	24	<b>50</b>	50	No	403292	0.0966
634-112	119	<b>12</b>	12	No	400413	0.4367	637X420	24	<b>50</b>	50	No	481641	0.0567
634-112PK5	119	<b>5</b>	5	Yes	409034	0.47	637X423PK	24	<b>10</b>	10	Yes	401663	0.1209
634-115	119	<b>12</b>	12	No	402936	0.5075	637XG711	25	<b>20</b>	20	No	423047	0.0965
634-118	119	<b>12</b>	12	No	402943	0.601	637XG721	25	<b>20</b>	20	No	423030	0.0958
634-118PK5	119	<b>5</b>	5	Yes	409096	0.6317	637XG920	32	<b>25</b>	250	No	415301	0.11
634-124	119	<b>12</b>	12	No	400437	0.8067	637XG920PK1	32	<b>10</b>	10	Yes	415318	0.16
634-124PK5	119	<b>5</b>	5	Yes	409119	0.8296	637XG9220	32	<b>25</b>	250	No	415325	0.1229
634-315	118	<b>12</b>	12	No	402974	0.456	637XG9220PK1	32	<b>10</b>	10	Yes	415493	0.0215
634-318	118	<b>12</b>	12	No	402981	0.54	638VG208E4	81	<b>25</b>	25	No	421968	0.3122
634-324	118	<b>12</b>	12	No	408983	0.664	638VG218E4	81	<b>25</b>	25	No	421951	0.5265
634-3F3F12	120	<b>10</b>	10	Yes	502469	0.3762	638WG208	64	<b>50</b>	50	No	411150	0.2435
634-3F3F18	120	<b>10</b>	10	Yes	502476	0.5012	638WG212E	64	<b>50</b>	50	No	406774	0.3677
634-3F3F24	120	<b>10</b>	10	Yes	502483	0.5975	638WG215	64	<b>50</b>	50	No	411167	0.3968
634-4F3F18	120	<b>10</b>	10	Yes	502421	0.57	638X208	27	<b>100</b>	100	No	403360	0.1767
634-4F4F18	120	<b>10</b>	10	Yes	502438	0.7475	638X208PK	27	<b>20</b>	20	Yes	481306	0.1906
634-C118	95	<b>25</b>	25	No	402998	0.6223	638X212	27	<b>100</b>	100	No	481320	0.2613
634-CG118FP	95	<b>25</b>	25	No	407887	1.16	638X212E	27	<b>50</b>	50	No	499837	0.3187
634Q418	139	<b>12</b>	12	No	410757	0.6498	638X218E	27	<b>25</b>	25	No	418746	0.4211
634Q418FP	139	<b>10</b>	10	No	410764	1.3857	638X312	27	<b>50</b>	50	No	403384	0.4503
634WG418	65	<b>25</b>	25	No	406767	0.6443	640PX12	52	<b>1</b>	20	No	439932	0.2625
634WG418FP	65	<b>25</b>	25	No	407894	1.168	640PX13	52	<b>1</b>	20	No	440358	0.0138
634X418	29	<b>10</b>	10	Yes	403018	0.5554	640PX14	52	<b>1</b>	10	No	442666	0.0169
634XG418FP	29	<b>25</b>	25	Yes	407900	1.106	640WP02	76	<b>25</b>	1000	No	423733	0.008
636-3L10888	121	<b>10</b>	10	No	403094	1.856	640WP03	76	<b>25</b>	750	No	423740	0.0088
636-3TR	121	<b>25</b>	25	No	403117	0.6752	640WP04	76	<b>10</b>	360	No	423757	0.0169
636-4L10888	121	<b>10</b>	10	No	403124	2.16	640WP5	76	<b>1</b>	5	Yes	710130	-
636-L3888	121	<b>25</b>	25	No	403155	0.843	640WP6	76	<b>1</b>	5	Yes	710147	-
636X38883	30	<b>12</b>	12	No	403162	1.5937	640WP7	76	<b>1</b>	5	Yes	710154	-
636X48884	30	<b>12</b>	12	No	403193	2.0071	640XG01	19	<b>100</b>	1000	No	404626	0.0161
637-B23HWP	618	<b>5</b>	20	Yes	447050	0.17	640XG02	19	<b>100</b>	1000	No	408648	0.018
637-C20	91	<b>25</b>	25	No	403209	0.1108	640XG03	19	<b>100</b>	1000	No	408655	0.0386
637-C20PK2	91	<b>10</b>	10	Yes	493088	0.1331	640XG04	19	<b>25</b>	250	No	408662	0.0764
637-G23H	112	<b>20</b>	20	No	205124	0.1925	641PX222	52	<b>1</b>	10	No	443618	0.7
637-G23H	618	<b>20</b>	20	No	205124	0.1925	641PX223	52	<b>1</b>	10	No	443823	0.425
637PX20	53	<b>1</b>	10	Yes	439451	1.54	641PX322	52	<b>1</b>	10	No	450531	0.445
637PX25	53	<b>1</b>	10	No	439482	1.73	641PX323	52	<b>1</b>	10	No	450982	0.54
637Q2	136	<b>12</b>	12	Yes	410979	0.1238	641PX332	52	<b>1</b>	10	No	457134	0.496
637QK900	722	<b>5</b>	60	Yes	681065	-	641PX333	52	<b>1</b>	10	No	457547	0.6077
637QK911	722	<b>5</b>	60	Yes	437457	-	641PX334	52	<b>1</b>	10	No	457844	0.825
637QK911M	722	<b>5</b>	60	Yes	681089	-	641PX433	52	<b>1</b>	10	No	457851	0.97
637QK980M	722	<b>5</b>	60	Yes	681096	-	641PX434	52	<b>1</b>	10	No	457882	1.14
637WP20	76	<b>25</b>	500	No	423719	0.0286	641PX442	52	<b>1</b>	10	No	457899	0.0498

Supply

Drainage

Support

Specialties

Appendix

# Numerical Index

Supply

Drainage

Support

Specialties

Appendix

Item No	Page No	Min Qty	Case Qty	UPC Bar-Coded	UPC 6-Digit	Weight (lbs.)	Item No	Page No	Min Qty	Case Qty	UPC Bar-Coded	UPC 6-Digit	Weight (lbs.)
641PX443	52	<b>1</b>	10	No	457905	0.0538	641WP553	75	<b>1</b>	5	Yes	710192	0.705
641PX444	52	<b>1</b>	10	No	457912	0.0575	641WP554	75	<b>1</b>	5	Yes	710208	-
641Q3-3Q2	134	<b>1</b>	6	Yes	424075	0.4	641WP555	74	<b>1</b>	5	Yes	710215	0.805
641QG222	133	<b>12</b>	12	Yes	415912	0.2312	641WP636	75	<b>1</b>	5	Yes	710222	-
641QG222F	133	<b>6</b>	6	Yes	415929	0.2492	641WP646	75	<b>1</b>	5	Yes	710239	-
641QG222M	133	<b>6</b>	6	Yes	415936	0.2333	641WP655	75	<b>1</b>	5	Yes	710246	-
641QG223	133	<b>6</b>	6	Yes	415943	0.3083	641WP656	75	<b>1</b>	5	Yes	710253	-
641QG224	133	<b>6</b>	6	Yes	415950	0.3833	641WP663	75	<b>1</b>	5	Yes	710260	-
641QG322	133	<b>12</b>	12	Yes	415967	0.295	641WP664	75	<b>1</b>	5	Yes	710277	-
641QG323	133	<b>6</b>	6	Yes	415974	0.3692	641WP665	75	<b>1</b>	5	Yes	710284	0.99
641QG332	133	<b>6</b>	6	Yes	415981	0.3558	641WP666	74	<b>1</b>	5	Yes	710291	-
641QG333	133	<b>12</b>	12	Yes	415998	0.3912	641WP747	75	<b>1</b>	5	Yes	710307	-
641QG333F	133	<b>6</b>	6	Yes	416001	0.4925	641WP757	75	<b>1</b>	5	Yes	710314	-
641QG333M	133	<b>6</b>	6	Yes	416018	0.4142	641WP774	75	<b>1</b>	5	Yes	710321	-
641QG334	133	<b>6</b>	6	Yes	416025	0.5108	641WP775	75	<b>1</b>	5	Yes	710338	2.2
641QG424	133	<b>6</b>	6	Yes	416032	0.5408	641WP776	75	<b>1</b>	5	Yes	710345	-
641QG443	133	<b>6</b>	6	Yes	416049	0.5592	641WP777	74	<b>1</b>	5	Yes	710352	-
641QG444	133	<b>6</b>	6	Yes	416056	0.6683	641XG111	18	<b>50</b>	500	No	404893	0.0555
641QG555	133	<b>3</b>	3	Yes	416063	1.5833	641XG222	18	<b>50</b>	50	No	404909	0.057
641QG666	133	<b>3</b>	3	Yes	416070	2.5167	641XG223	19	<b>20</b>	200	No	404916	0.128
641QG777	133	<b>3</b>	3	Yes	416087	3.8517	641XG322	18	<b>20</b>	200	No	404923	0.112
641QK000	721	<b>5</b>	60	Yes	681102	-	641XG323	18	<b>20</b>	200	No	404930	0.1088
641QK111	721	<b>5</b>	60	Yes	681119	-	641XG332	18	<b>20</b>	200	No	404947	0.1156
641QK222	721	<b>5</b>	60	Yes	681126	-	641XG333	18	<b>20</b>	200	No	405098	0.116
641WG222	57	<b>50</b>	50	No	409447	0.136	641XG442	18	<b>20</b>	200	No	405111	0.2149
641WG223	58	<b>20</b>	20	No	409454	0.2534	641XG443	18	<b>20</b>	200	No	405166	0.158
641WG322	57	<b>20</b>	20	No	409461	0.2751	641XG444	18	<b>20</b>	200	No	405234	0.2282
641WG323	57	<b>20</b>	20	No	409478	0.2766	642PX2	51	<b>1</b>	10	No	457936	0.274
641WG332	57	<b>20</b>	20	No	409485	0.2913	642PX3	51	<b>1</b>	10	No	457943	0.59
641WG333	57	<b>20</b>	20	No	409492	0.2888	642PX32	51	<b>1</b>	10	No	457950	0.46
641WG334	58	<b>20</b>	20	No	409508	0.4425	642PX4	51	<b>1</b>	10	No	457967	1.21
641WG433	57	<b>20</b>	20	No	409515	0.4575	642QG2	133	<b>12</b>	12	Yes	416094	0.2996
641WG442	57	<b>20</b>	20	No	409522	0.474	642QG3	133	<b>12</b>	12	Yes	416100	0.3017
641WG443	57	<b>20</b>	20	No	409546	0.5	642QG32	133	<b>6</b>	6	Yes	416117	0.2558
641WG444	57	<b>20</b>	20	No	409553	0.5035	642QG4	133	<b>6</b>	6	Yes	416124	0.4942
641WP222	74	<b>25</b>	500	No	423764	0.0211	642QG43	133	<b>6</b>	6	Yes	416131	0.4067
641WP223	75	<b>25</b>	300	No	423771	0.0278	642QG5	133	<b>3</b>	3	Yes	416148	1.195
641WP322	74	<b>25</b>	300	No	423788	0.0345	642QG6	133	<b>3</b>	3	Yes	416155	1.8833
641WP323	74	<b>25</b>	250	No	423795	0.0357	642QG7	133	<b>3</b>	3	Yes	416162	2.8667
641WP332	74	<b>25</b>	250	No	423801	0.0338	642QK0	721	<b>5</b>	60	Yes	681133	-
641WP333	74	<b>25</b>	200	No	423818	0.0412	642QK1	721	<b>5</b>	60	Yes	681140	-
641WP334	75	<b>10</b>	140	No	714992	-	642WG2	57	<b>25</b>	25	No	409560	0.116
641WP433	74	<b>10</b>	140	No	715005	-	642WG3	57	<b>25</b>	25	No	409577	0.2631
641WP434	74	<b>10</b>	120	No	715012	-	642WG4	57	<b>25</b>	25	No	409584	0.3832
641WP442	74	<b>10</b>	150	No	715029	-	642WP2	74	<b>25</b>	625	No	423849	0.0146
641WP443	74	<b>10</b>	120	No	423825	0.0632	642WP3	74	<b>25</b>	375	No	423856	0.0295
641WP444	74	<b>10</b>	100	No	423832	0.089	642WP4	74	<b>10</b>	160	No	423863	0.0541
641WP535	74	<b>1</b>	5	Yes	710161	-	642WP5	74	<b>1</b>	5	Yes	710369	0.655
641WP545	75	<b>1</b>	5	Yes	710178	-	642WP6	74	<b>1</b>	5	Yes	710376	-
641WP552	75	<b>1</b>	5	Yes	710185	0.1	642WP7	74	<b>1</b>	5	Yes	710383	-



Item No	Page No	Min Qty	Case Qty	UPC Bar-Coded	UPC 6-Digit	Weight (lbs.)	Item No	Page No	Min Qty	Case Qty	UPC Bar-Coded	UPC 6-Digit	Weight (lbs.)
642X2	18	<b>25</b>	250	No	487063	0.0426	643XG34	21	<b>25</b>	250	No	408785	0.076
642X3	18	<b>25</b>	250	No	487100	0.0899	643XG4	21	<b>25</b>	250	No	408792	0.1106
642X4	18	<b>25</b>	25	No	487148	0.2041	643XG43	21	<b>25</b>	250	No	408808	0.1132
642X43	18	<b>25</b>	25	No	405937	0.2041	644WG2	60	<b>100</b>	100	No	409737	0.0661
642XG1	18	<b>25</b>	250	No	408679	0.0528	644WG23	60	<b>50</b>	50	No	409676	0.097
642XG2	18	<b>25</b>	250	No	408686	0.0384	644WG3	60	<b>50</b>	50	No	409744	0.1471
642XG23	18	<b>25</b>	250	No	408693	0.0574	644WG32	60	<b>50</b>	50	No	409973	0.0076
642XG2PK1	18	<b>10</b>	10	Yes	457325	0.065	644WG4	60	<b>25</b>	25	No	409751	0.2641
642XG3	18	<b>25</b>	250	No	408709	0.1099	644WG43	60	<b>25</b>	25	No	409768	0.208
642XG4	18	<b>25</b>	25	No	408716	0.218	644WG5	60	<b>5</b>	5	No	409775	0.354
642XG43	18	<b>25</b>	25	No	408723	0.18	644WG6	60	<b>5</b>	5	No	409782	0.5503
643-C211	90	<b>100</b>	100	No	403766	0.2608	644WG7	60	<b>5</b>	5	No	409799	1.0287
643-C311	90	<b>50</b>	50	No	403773	0.4389	644X2	21	<b>100</b>	1000	No	495273	0.0281
643-C418	90	25	25	No	403780	1.0182	644X23	21	<b>25</b>	100	No	443212	0.041
643-C518	90	10	10	No	407498	1.492	644X3	21	<b>50</b>	500	No	495280	0.0569
643-C620	90	1	10	No	465443	2.1385	644X32	21	<b>50</b>	500	No	482105	0.0566
643-C722	90	1	10	No	407504	3.3069	644X34	21	<b>25</b>	250	No	403971	0.0756
643-C9211	101	<b>25</b>	25	No	402622	0.28	644X4	21	<b>25</b>	250	No	482266	0.1125
643-C9311	101	<b>25</b>	25	No	410139	0.44	644X43	21	<b>25</b>	250	No	403995	0.1064
643-C9418	101	<b>25</b>	25	No	410160	0.994	644XG1	21	<b>100</b>	500	No	408815	0.0435
643-P311	105	50	50	No	407511	0.4335	644XG2	21	<b>100</b>	1000	No	408822	0.036
643-P418	105	25	25	No	407535	1.069	644XG3	21	<b>50</b>	500	No	408839	0.0671
643-P518	105	1	10	No	407528	1.4993	644XG32	21	<b>50</b>	500	No	408846	0.0707
643-P620	105	1	10	No	407542	2.1377	644XG4	21	<b>25</b>	250	No	408853	0.065
643-P722	105	1	10	No	407559	3.5104	644XG43	21	<b>25</b>	250	No	408860	0.1346
643WG2	59	<b>100</b>	100	No	409591	0.0515	645PX2	52	<b>1</b>	20	No	457981	0.326
643WG23	59	<b>50</b>	50	No	409393	0.094	645PX3	52	<b>1</b>	20	No	457998	0.3475
643WG3	59	<b>50</b>	50	No	409669	0.1138	645PX32	52	<b>1</b>	20	No	458001	0.26
643WG32	59	<b>50</b>	50	No	409409	0.0814	645PX4	52	<b>1</b>	10	No	458018	0.705
643WG4	59	<b>25</b>	25	No	409683	0.2015	645PX42	52	<b>1</b>	10	No	458025	0.47
643WG43	59	<b>25</b>	25	No	409690	0.1412	645PX43	52	<b>1</b>	10	No	458032	0.575
643WG5	59	<b>5</b>	5	No	409706	0.33	645Q2-3	134	10	10	Yes	423993	0.145
643WG6	59	<b>5</b>	5	No	409713	0.468	645Q3-2	134	10	10	Yes	424006	0.17
643WG7	59	<b>5</b>	5	No	409720	1.0486	645QG2	134	<b>12</b>	12	Yes	416179	0.1433
643X11	21	<b>100</b>	1000	No	403803	0.0208	645QG3	134	<b>12</b>	12	Yes	416186	0.2458
643X2	21	<b>100</b>	1000	No	481764	0.0262	645QG32	134	<b>6</b>	6	Yes	416193	0.2017
643X202	21	<b>50</b>	500	No	403827	0.0442	645QG4	134	<b>6</b>	6	Yes	416209	0.3492
643X208	27	<b>100</b>	100	No	403834	0.174	645QG43	134	<b>6</b>	6	Yes	416216	0.3058
643X212	27	<b>100</b>	100	No	403841	0.2613	645QG5	134	<b>3</b>	3	Yes	416223	0.9167
643X23	21	<b>50</b>	100	No	481771	0.0353	645QG54	134	<b>3</b>	3	Yes	416230	0.6833
643X3	21	<b>50</b>	500	No	481849	0.0524	645QG6	134	<b>3</b>	3	Yes	416247	1.5
643X32	21	<b>50</b>	500	No	481801	0.0528	645QG65	134	<b>3</b>	3	Yes	416254	1.2017
643X34	21	<b>25</b>	250	No	403889	0.0866	645QG7	134	<b>3</b>	3	Yes	416261	2.1167
643X4	21	<b>25</b>	250	No	481924	0.1048	645QG76	134	<b>3</b>	3	Yes	416278	1.8333
643X43	21	<b>25</b>	250	No	403902	0.0846	645QK0	721	<b>5</b>	60	Yes	681157	-
643XG1	21	<b>100</b>	1000	No	408730	0.0339	645QK1	721	<b>5</b>	60	Yes	681164	-
643XG2	21	<b>100</b>	1000	No	408747	0.0346	645QK10	721	<b>5</b>	60	Yes	681171	-
643XG23	21	<b>50</b>	500	No	408754	0.0422	645QK2	721	<b>5</b>	60	Yes	681188	-
643XG3	21	<b>50</b>	500	No	408761	0.0172	645QK9	721	<b>5</b>	60	Yes	681195	-
643XG32	21	<b>50</b>	500	No	408778	0.0622	645QK90	721	<b>5</b>	60	Yes	681201	-

Supply

Drainage

Support

Specialties

Appendix

# Numerical Index

Supply

Drainage

Support

Specialties

Appendix

Item No	Page No	Min Qty	Case Qty	UPC Bar-Coded	UPC 6-Digit	Weight (lbs.)	Item No	Page No	Min Qty	Case Qty	UPC Bar-Coded	UPC 6-Digit	Weight (lbs.)
645VGC2	81	<b>50</b>	50	No	413352	0.11	<b>645X2G</b>	25	<b>50</b>	50	No	482549	0.058
645VGC2	89	<b>50</b>	50	No	413352	0.11	<b>645X2GPK2</b>	25	<b>10</b>	10	Yes	482549	0.0758
645VGC3	81	<b>50</b>	50	No	413383	0.215	<b>645X3</b>	19	<b>50</b>	500	No	482440	0.0382
645VGC3	89	<b>50</b>	50	No	413383	0.215	<b>645X32</b>	19	<b>50</b>	500	No	482402	0.0366
645VGC4	81	<b>20</b>	20	No	413390	0.368	<b>645X34P</b>	20	<b>20</b>	20	No	495853	0.3074
645VGC4	89	<b>20</b>	20	No	413390	0.368	<b>645X34P</b>	105	<b>20</b>	20	No	495853	0.3074
645WG2	58	<b>100</b>	100	No	409805	0.0635	<b>645X3G</b>	25	<b>50</b>	50	No	482563	0.0799
645WG3	58	<b>50</b>	50	No	409812	0.1302	<b>645X3GPK2</b>	25	<b>10</b>	10	Yes	482563	0.0938
645WG32	58	<b>50</b>	50	No	409829	0.1122	<b>645X3P</b>	20	<b>50</b>	50	No	495945	0.2001
645WG3P	59	<b>50</b>	50	No	404879	0.2896	<b>645X3P</b>	105	<b>50</b>	50	No	495945	0.2001
645WG3P	105	<b>50</b>	50	No	404879	0.2896	<b>645X4</b>	19	<b>25</b>	250	No	482525	0.0807
645WG4	58	<b>25</b>	25	No	409836	0.2308	<b>645X43</b>	19	<b>25</b>	250	No	482488	0.0711
645WG43	58	<b>25</b>	25	No	409843	0.1929	<b>645X43P</b>	20	<b>20</b>	20	No	495860	0.2261
645WG4P	59	<b>20</b>	20	No	404886	0.4777	<b>645X43P</b>	105	<b>20</b>	20	No	495860	0.2261
645WG4P	105	<b>20</b>	20	No	404886	0.4777	<b>645X4P</b>	20	<b>20</b>	20	No	495846	0.1606
645WGC2	58	<b>50</b>	50	No	406781	0.076	<b>645X4P</b>	105	<b>20</b>	20	No	495846	0.1606
645WGC2	89	<b>50</b>	50	No	406781	0.076	<b>645XC2</b>	20	<b>50</b>	50	No	404152	0.0684
645WGC3	58	<b>50</b>	50	No	406798	0.159	<b>645XC2</b>	89	<b>50</b>	50	No	404152	0.0684
645WGC3	89	<b>50</b>	50	No	406798	0.159	<b>645XC23</b>	20	<b>50</b>	50	No	496225	0.171
645WGC4	58	<b>20</b>	20	No	406804	0.4737	<b>645XC23</b>	89	<b>50</b>	50	No	496225	0.171
645WGC4	89	<b>20</b>	20	No	406804	0.4737	<b>645XC2PK2</b>	20	<b>10</b>	10	Yes	482051	0.0908
645WGC5	58	5	5	No	450159	0.76	<b>645XC2PK2</b>	89	<b>10</b>	10	Yes	482051	0.0908
645WGC5	89	5	5	No	450159	0.76	<b>645XC3</b>	20	<b>50</b>	50	No	404169	0.1267
645WGC6	58	5	5	No	450142	1.01	<b>645XC3</b>	89	<b>50</b>	50	No	404169	0.1267
645WGC6	89	5	5	No	450142	1.01	<b>645XC34</b>	20	<b>20</b>	20	No	496119	0.2989
645WGC7	58	5	5	No	410283	1.91	<b>645XC34</b>	89	<b>20</b>	20	No	496119	0.2989
645WGC7	89	5	5	No	410283	1.91	<b>645XC3PK2</b>	20	<b>10</b>	10	Yes	482136	0.1493
645WGC93	59	<b>50</b>	50	No	713308	0.245	<b>645XC3PK2</b>	89	<b>10</b>	10	Yes	482136	0.1493
645WGC93	101	<b>50</b>	50	No	713308	0.245	<b>645XC4</b>	20	<b>20</b>	20	No	404176	0.2025
645WGC94	59	<b>20</b>	20	No	713315	0.4025	<b>645XC4</b>	89	<b>20</b>	20	No	404176	0.2025
645WGC94	101	<b>20</b>	20	No	713315	0.4025	<b>645XC43</b>	20	<b>20</b>	20	No	496201	0.2036
645WGC95	59	10	10	No	713384	0.795	<b>645XC43</b>	89	<b>20</b>	20	No	496201	0.2036
645WGC95	101	10	10	No	713384	0.795	<b>645XC923</b>	20	25	25	No	713711	0.214
645WP2	75	<b>25</b>	1000	No	423870	0.0121	<b>645XC923</b>	101	25	25	No	713711	0.214
645WP3	75	<b>25</b>	500	No	423894	0.0214	<b>645XC93</b>	20	<b>50</b>	50	No	712363	0.142
645WP32	75	<b>25</b>	500	No	423887	0.0191	<b>645XC93</b>	101	<b>50</b>	50	No	712363	0.142
645WP4	75	<b>10</b>	200	No	423917	0.0392	<b>645XC94</b>	20	<b>20</b>	20	No	712370	0.2125
645WP42	75	<b>25</b>	250	No	715180	-	<b>645XC94</b>	101	<b>20</b>	20	No	712370	0.2125
645WP43	75	<b>25</b>	250	No	423900	0.0326	<b>645XCM2</b>	20	<b>50</b>	50	No	457042	0.06
645WP5	75	<b>1</b>	5	Yes	710390	-	<b>645XCM2</b>	89	<b>50</b>	50	No	457042	0.06
645WP53	75	<b>1</b>	5	Yes	710406	0.445	<b>645XG1</b>	19	<b>100</b>	1000	No	408877	0.0211
645WP54	75	<b>1</b>	5	Yes	710413	0.465	<b>645XG12</b>	19	<b>50</b>	500	No	408884	0.0267
645WP6	75	<b>1</b>	5	Yes	710420	-	<b>645XG2</b>	19	<b>100</b>	1000	No	408891	0.0278
645WP65	75	<b>1</b>	5	Yes	710437	-	<b>645XG3</b>	19	<b>50</b>	500	No	408907	0.048
645WP7	75	<b>1</b>	5	Yes	710444	-	<b>645XG32</b>	19	<b>50</b>	500	No	408914	0.0414
645WP76	75	<b>1</b>	5	Yes	710451	1.09	<b>645XG4</b>	19	<b>25</b>	250	No	408921	0.0808
645X1	19	<b>100</b>	1000	No	482327	0.0152	<b>645XG43</b>	19	<b>25</b>	250	No	408938	0.07
645X2	19	<b>100</b>	1000	No	482365	0.0234	<b>645XG2</b>	20	<b>50</b>	50	No	728579	-
645X23P	20	<b>50</b>	50	No	495983	0.2009	<b>645XG3</b>	20	<b>50</b>	50	No	728586	-
645X23P	105	<b>50</b>	50	No	495983	0.2009	<b>645XG4</b>	20	<b>20</b>	20	No	728593	-

Item No	Page No	Min Qty	Case Qty	UPC Bar-Coded	UPC 6-Digit	Weight (lbs.)	Item No	Page No	Min Qty	Case Qty	UPC Bar-Coded	UPC 6-Digit	Weight (lbs.)
646-C4308	95	<b>25</b>	25	No	496836	0.5361	646WG4	60	<b>25</b>	25	No	409898	0.2987
646-CG2	90	<b>50</b>	50	No	406897	0.0925	646WG43	60	<b>25</b>	25	No	409904	0.326
646-CG2PK1	90	<b>25</b>	25	Yes	416728	0.0941	646WG5	60	<b>5</b>	5	No	409911	0.654
646-CG3	90	<b>50</b>	50	No	406903	0.1608	646WG6	60	<b>5</b>	5	No	409928	0.9053
646-CG318	95	<b>25</b>	25	No	415608	0.786	646WG7	60	<b>5</b>	5	No	409935	1.8665
646-CG318FP	95	<b>10</b>	10	No	415363	1.37	646WP2	76	<b>25</b>	800	No	423924	0.0162
646-CG4	90	<b>20</b>	20	No	406910	0.0618	646WP3	76	<b>25</b>	500	No	423931	-
646-CG5	90	10	10	No	101297	0.535	646WP32	76	<b>10</b>	400	No	423986	0.024
646-CG6	90	10	10	No	101358	0.01	646WP4	76	<b>10</b>	200	No	715210	-
646-CG7	90	10	10	No	101402	1.16	646XG2	22	<b>100</b>	100	No	406958	0.1082
646-CG92	101	<b>50</b>	50	No	458285	-	646XG23	22	<b>50</b>	50	No	408945	0.088
646-CG93	101	<b>50</b>	50	No	458292	0.223	646XG3	22	<b>25</b>	250	No	406972	0.171
646-CG94	101	<b>20</b>	20	No	733177	0.3925	646XG32	22	<b>50</b>	50	No	406989	0.128
646-CG95	101	10	10	No	708502	0.7	646XG34	22	<b>25</b>	25	No	406996	0.148
646-CG96	101	10	10	No	708519	0.805	646XG4	22	<b>50</b>	50	No	407054	0.206
646-CG97	101	10	10	No	708526	1.22	646XG43	22	<b>50</b>	50	No	408952	0.2739
646-GP4312FD	121	<b>25</b>	25	No	412232	1.509	647-C2D	91	<b>50</b>	50	No	404558	0.2052
646-GP4412FD	121	<b>25</b>	25	No	412256	2.124	647-C2DW	91	<b>50</b>	50	No	404565	0.2248
646-PG3	106	<b>50</b>	50	No	407177	0.2789	647-C3E	92	<b>25</b>	25	No	407566	0.4312
646-PG4	106	<b>20</b>	20	No	407191	0.4165	647-C4E	92	<b>10</b>	10	No	407573	0.7242
646-PG5	106	10	10	No	404503	0.71	647-CG2	90	<b>50</b>	50	No	406927	0.1073
646-PG6	106	10	10	No	404527	0.795	647-CG2E3	92	<b>50</b>	50	No	415530	0.3414
646-PG7	106	10	10	No	404541	1.24	647-CG2E3PK1	92	<b>10</b>	10	Yes	415547	0.341
646PX2	53	<b>1</b>	10	No	458049	0.166	647-CG2PK1	90	<b>25</b>	25	Yes	416742	0.1021
646PX23	53	<b>1</b>	10	No	458056	0.665	647-CG3	90	<b>50</b>	50	No	406934	0.164
646PX3	53	<b>1</b>	10	No	458063	0.634	647-CG3PK1	90	<b>25</b>	25	Yes	416759	0.162
646PX32	53	<b>1</b>	10	No	458070	0.58	647-CG4	90	<b>20</b>	20	No	406941	0.4251
646PX4	53	<b>1</b>	10	No	458087	1.18	647-CG5	90	10	10	No	101419	0.555
646QG2	135	<b>12</b>	12	Yes	416285	0.135	647-CG6	90	10	10	No	101426	0.1266
646QG3	135	<b>12</b>	12	Yes	416292	0.2075	647-CG7	90	10	10	No	404442	0.2122
646QG32	135	<b>6</b>	6	Yes	416308	0.2042	647-CG92	102	<b>50</b>	50	No	458308	-
646QG34	135	<b>6</b>	6	Yes	416315	0.2883	647-CG93	102	<b>50</b>	50	No	458315	0.253
646QG4	135	<b>6</b>	6	Yes	416322	0.2883	647-CG94	102	20	20	No	733184	-
646QG5	135	<b>3</b>	3	Yes	416339	0.7867	647-CG95	102	10	10	No	708533	0.59
646QG6	135	<b>3</b>	3	Yes	416346	1.0683	647-CG96	102	10	10	No	708557	0.765
646QG7	135	<b>3</b>	3	Yes	416353	1.4833	647-CG97	102	10	10	No	708564	0.925
646QK0	722	<b>5</b>	60	Yes	681218	-	647-PG3	106	<b>50</b>	50	No	407245	0.2894
646QK01	722	<b>5</b>	60	Yes	681225	-	647-PG4	106	<b>20</b>	20	No	407252	0.4276
646QK1	722	<b>5</b>	60	Yes	681232	-	647-PG5	106	10	10	No	404688	0.58
646QK10	722	<b>5</b>	60	Yes	681249	-	647-PG6	106	10	10	No	406224	0.745
646QK12	722	<b>5</b>	60	Yes	681256	-	647-PG7	106	10	10	No	406491	0.94
646QK2	722	<b>5</b>	60	Yes	681263	-	647QG2	136	<b>12</b>	12	Yes	416360	0.1458
646QK20	722	<b>5</b>	60	Yes	681270	-	647QG2E3	136	<b>6</b>	6	Yes	416377	0.2458
646QK21	722	<b>5</b>	60	Yes	681287	-	647QG3	136	<b>12</b>	12	Yes	416384	0.2408
646QK80	722	<b>5</b>	60	Yes	681294	-	647QG32	136	<b>6</b>	6	Yes	416391	0.2042
646QK81	722	<b>5</b>	60	Yes	681300	-	647QG34	136	<b>6</b>	6	Yes	416407	0.2908
646WG2	60	<b>100</b>	100	No	409850	0.1212	647QG4	136	<b>12</b>	12	Yes	416414	0.3217
646WG3	60	<b>25</b>	25	No	409867	0.1883	647QG43	136	<b>6</b>	6	Yes	416421	0.2533
646WG32	60	<b>25</b>	25	No	409874	0.184	647QG5	136	<b>3</b>	3	Yes	416438	0.7933
646WG34	60	<b>25</b>	25	No	409881	0.226	647QG6	136	<b>3</b>	3	Yes	416445	1.11

Supply

Drainage

Support

Specialties

Appendix

# Numerical Index

Supply

Drainage

Support

Specialties

Appendix

Item No	Page No	Min Qty	Case Qty	UPC Bar-Coded	UPC 6-Digit	Weight (lbs.)	Item No	Page No	Min Qty	Case Qty	UPC Bar-Coded	UPC 6-Digit	Weight (lbs.)
647QG7	136	<b>3</b>	3	Yes	416452	1.5683	648VG4FP	82	<b>10</b>	10	No	413017	1.48
647QK0	722	<b>5</b>	60	Yes	681317	-	648WG-2	66	<b>6</b>	108	Yes	406446	0.2986
647QK10	722	<b>5</b>	60	Yes	681324	-	648WG2FPD	66	<b>10</b>	10	No	423054	0.5381
647WG2	61	<b>50</b>	50	No	409942	0.1391	648WG2FPPK1	66	<b>10</b>	100	Yes	412362	0.2947
647WG23	61	<b>50</b>	50	No	409959	0.1684	648WG-3	66	<b>6</b>	72	Yes	406552	0.4889
647WG2E3	61	<b>50</b>	50	No	416698	0.2	648-WG3CR	122	<b>6</b>	6	Yes	724458	-
647WG3	61	<b>50</b>	50	No	409966	0.196	648WG3FPD	66	<b>6</b>	6	No	423115	0.925
647WG32	61	<b>25</b>	25	No	409607	0.2084	648WG3FPPK1	66	<b>10</b>	100	Yes	412379	0.4334
647WG4	61	<b>25</b>	25	No	409980	0.4363	648-WG3HR	122	<b>6</b>	6	Yes	724465	0.9417
647WG43	61	<b>25</b>	25	No	409997	0.3923	648-WG3WR	122	<b>6</b>	6	Yes	724472	0.9583
647WG5	61	<b>5</b>	5	No	410016	0.5503	648WG3WRV	66	<b>6</b>	6	Yes	723659	-
647WG6	61	<b>5</b>	5	No	410030	0.8236	648WG-4	66	<b>6</b>	36	Yes	406583	0.7611
647WG7	61	<b>5</b>	5	No	410535	1.6813	648WG4FPPK1	66	<b>12</b>	60	Yes	412348	0.7779
647X23E	23	<b>50</b>	50	No	482938	0.2462	648WG5FP	66	<b>5</b>	5	No	415714	2.025
647XG2	22	<b>50</b>	250	No	407092	0.0798	648WG6FP	66	<b>1</b>	1	No	415721	3.31
647XG21E3	23	<b>25</b>	25	No	445346	0.238	648WG7FP	66	<b>1</b>	1	No	415738	5.91
647XG23PK2	22	<b>10</b>	10	Yes	407115	0.2129	648XG2	30	<b>10</b>	120	No	406866	0.2729
647XG2E3	23	<b>50</b>	50	No	710000	0.194	648XG2FA	612	<b>5</b>	60	No	202734	0.1662
647XG2EPK1	23	<b>20</b>	20	No	415585	0.293	648XG2FPD	31	<b>5</b>	30	No	445124	0.3083
647XG3	22	<b>50</b>	50	No	407139	0.109	648XG2PK	30	<b>10</b>	10	Yes	412966	0.232
647XG4	22	<b>50</b>	50	No	407153	0.25	648XG3	30	<b>8</b>	96	No	406873	0.2896
648-3SM	120	<b>5</b>	5	Yes	713070	-	648-XG3CR	122	<b>6</b>	6	Yes	724489	-
648-3SMARX	122	<b>6</b>	6	Yes	726421	-	648XG3FPD	31	<b>5</b>	30	No	445100	0.45
648-3SW	66	<b>1</b>	5	Yes	435706	-	648-XG3HR	122	<b>6</b>	6	Yes	724496	-
648-3SW	120	<b>1</b>	5	Yes	435706	-	648XG3PK	30	<b>10</b>	10	Yes	412973	0.3235
648-3SX	31	<b>5</b>	5	No	735195	-	648-XG3XR	122	<b>6</b>	6	Yes	724502	0.9167
648-3SX	120	<b>5</b>	5	No	735195	-	648XG3XRV	31	<b>6</b>	6	Yes	723642	-
648-ARW	65	<b>6</b>	6	Yes	726285	-	648XG4	30	<b>4</b>	40	No	406880	0.6763
648-ARX	29	<b>6</b>	6	Yes	726278	-	648XG4PK	30	<b>6</b>	6	Yes	412980	0.7265
648-ARX	122	<b>6</b>	6	Yes	726278	-	649TX2	17	<b>100</b>	1000	No	407603	0.0064
648-CG2FP	96	<b>10</b>	10	No	411921	0.7025	649TX2	51	<b>100</b>	1000	No	407603	0.0064
648-CG2FPD	96	<b>10</b>	10	No	412058	0.536	649TX3	17	<b>100</b>	500	No	407948	0.0095
648-CG3FP	96	<b>10</b>	10	No	412102	1.0427	649TX3	51	<b>100</b>	500	No	407948	0.0095
648-CG3FPD	96	<b>10</b>	10	No	412119	0.8972	649TX4	17	<b>25</b>	250	No	407955	0.0174
648-CG4FP	96	<b>10</b>	10	No	412126	1.256	649TX4	51	<b>25</b>	250	No	407955	0.0174
648-CG4FPD	96	<b>10</b>	10	No	412133	1.5452	649W2	57	<b>50</b>	1000	No	408617	0.0064
648-CG5FP	96	<b>5</b>	5	No	412140	2.7914	649W2	74	<b>50</b>	1000	No	408617	0.0064
648-CG6FP	96	<b>1</b>	1	No	412157	4.3159	649W3	57	<b>50</b>	500	No	410627	0.0119
648-CG7FP	96	<b>1</b>	1	No	412164	6.6868	649W3	74	<b>50</b>	500	No	410627	0.0119
648-PG3FP	107	<b>10</b>	10	No	415288	0.9502	649W4	57	<b>25</b>	250	No	408624	0.02
648-PG4FP	107	<b>10</b>	10	No	423597	1.48	649W4	74	<b>25</b>	250	No	408624	0.02
648-PG5FP	107	<b>5</b>	5	No	423580	2.8758	649WP2	57	<b>50</b>	1000	No	729347	0.0072
648-PG6FP	107	<b>1</b>	1	No	423573	3.9	649WP2	74	<b>50</b>	1000	No	729347	0.0072
648-PG7FP	107	<b>1</b>	1	No	415271	5.52	649WP3	57	<b>50</b>	500	No	729354	0.0129
648QG2	139	<b>12</b>	12	Yes	416469	0.4208	649WP3	74	<b>50</b>	500	No	729354	0.0129
648QG3	139	<b>12</b>	12	Yes	416490	0.681	649WP4	57	<b>25</b>	250	No	729415	0.0238
648QG4	139	<b>6</b>	6	Yes	416506	1.1542	649WP4	74	<b>25</b>	250	No	729415	0.0238
648QGD220A	610	<b>12</b>	12	Yes	416513	0.3217	649WP5	57	<b>10</b>	10	No	710468	0.52
648VG2FP	82	<b>10</b>	10	No	412997	0.59	649WP5	74	<b>10</b>	10	No	710468	0.52
648VG3FP	82	<b>10</b>	10	No	413000	0.9015	649WP6	57	<b>10</b>	10	No	710475	-

Item No	Page No	Min Qty	Case Qty	UPC Bar-Coded	UPC 6-Digit	Weight (lbs.)	Item No	Page No	Min Qty	Case Qty	UPC Bar-Coded	UPC 6-Digit	Weight (lbs.)
649WP6	74	<b>10</b>	10	No	710475	-	658S2002	157	1	1	No	107503	20.5
649WP7	57	<b>10</b>	10	No	710482	-	658S2004F2	157	1	1	No	107510	29.4572
649WP7	74	<b>10</b>	10	No	710482	-	658S4004F2	157	1	1	No	107565	41.3
649X1	17	<b>100</b>	1000	No	483522	0.0111	660-G2	153	6	6	Yes	154316	0.3821
649X1	51	<b>100</b>	1000	No	483522	0.0111	660-G2B	153	<b>50</b>	50	No	407832	0.262
649X2	17	<b>100</b>	1000	No	495327	0.0127	660-GTC0	154	6	6	Yes	415103	0.3625
649X2	51	<b>100</b>	1000	No	495327	0.0127	660-GTC0B	154	<b>25</b>	25	No	415110	0.2748
649X3	17	<b>100</b>	500	No	495334	0.0178	660-GTC1	154	6	6	Yes	415127	0.4575
649X3	51	<b>100</b>	500	No	495334	0.0178	660-GTC1B	154	25	25	No	415134	0.296
649X4	17	<b>25</b>	250	No	483645	0.024	660-GTR	155	6	6	Yes	154330	0.5917
649X4	51	<b>25</b>	250	No	483645	0.024	660-GTR0	155	6	6	Yes	415141	0.28
649X5	17	<b>25</b>	250	No	495457	0.0453	660-GTR0B	155	<b>25</b>	25	No	415158	0.28
649X6	17	<b>25</b>	250	No	495372	0.0786	660-GTR1	155	<b>6</b>	6	Yes	154347	0.5333
649X7	17	<b>10</b>	200	No	725646	-	660-GTR1B	155	<b>25</b>	25	No	407849	0.4452
649Y1PK1	18	1	200	Yes	706454	0.0625	660-GTRB	155	<b>25</b>	25	No	407856	0.5107
649Y1PK1	51	1	200	Yes	706454	0.0625	660-GTW2B	154	<b>25</b>	25	No	415790	0.3094
649Y2	18	1	20	Yes	706478	0.9675	660-GTX2	154	6	6	Yes	415165	0.468
649Y2	51	1	20	Yes	706478	0.9675	660-GTX2B	154	<b>25</b>	25	No	413123	0.416
649Y3	18	1	10	Yes	706492	0.157	660-GVPX2B	153	50	50	No	415196	0.31
649Y3	51	1	10	Yes	706492	0.157	660-H	153	6	6	Yes	106605	0.7005
649Y4PK1	18	1	10	Yes	706508	2.615	660-HB	153	<b>25</b>	25	No	106070	0.396
649Y4PK1	51	1	10	Yes	706508	2.615	660-HPK2	153	<b>20</b>	20	Yes	707925	0.8025
652-A	155	1	16	No	107527	0.609	660-Q2	153	1	6	Yes	457356	0.3334
652-AC	156	1	16	No	106780	0.698	660-Q2B	153	<b>50</b>	50	No	415479	0.211
652-AD	157	1	16	No	109668	0.652	660-S	153	6	6	Yes	106773	0.3275
652-AS	155	1	16	No	107022	0.6997	660-SB	153	<b>50</b>	50	No	106094	0.2409
652-AWG	156	1	16	No	423122	0.6232	660-TK	153	6	6	Yes	106162	0.55
652-AX	156	1	16	No	430311	0.5645	660-TKB	153	<b>25</b>	25	No	106186	0.4873
653-B	155	1	16	No	107534	0.7912	660-TS	153	25	25	No	106230	0.2834
653-BC	156	1	16	No	154101	0.8193	660-TS8	154	25	25	No	106247	0.4401
653-BS	155	1	16	No	107053	0.8445	660-TS88	154	25	25	No	106254	0.7332
653-BWG	156	1	16	No	422798	0.8472	660-TSWG	153	<b>25</b>	25	No	462411	0.3519
653-BX	156	1	16	No	430328	0.7294	660-TSWG8	154	25	25	No	400093	0.59
654-C	155	1	16	No	107541	1.03	660-TSX	153	25	25	No	109835	0.4465
654-CC	156	1	16	No	154118	1.2016	660-TSX88	154	25	25	No	109828	0.7954
654-CS	155	1	16	No	107084	1.0591	660-V82B	153	<b>50</b>	50	No	490759	0.1614
654-CWG	156	1	16	No	423139	1.1031	660-WG2B	153	<b>50</b>	50	No	406811	0.2257
654-CX	156	1	16	No	404466	0.9941	660-X2B	153	<b>50</b>	50	No	106315	0.1605
655-D	155	1	4	No	107558	2.0476	663-01212HS	146	<b>1</b>	1	No	710741	7.6
655-DS	155	1	4	No	107114	2.1239	663-01212SS	145	<b>1</b>	1	No	711083	8.7
656-E	155	1	4	No	107121	2.3756	663-03412HS	146	<b>1</b>	1	No	710765	7.65
656-ES	155	1	4	No	107145	2.4422	663-03412SS	145	<b>1</b>	1	No	711106	8.2
657-F	155	1	4	No	107152	2.7856	663-03838HS	146	<b>1</b>	1	No	710666	8.9
657-FD	157	1	4	No	109675	2.7856	663-03838SS	145	<b>1</b>	1	No	711007	10.75
657-FS	155	1	4	No	107176	2.9875	663-05810HS	146	<b>1</b>	1	No	710925	7.65
658-1503	156	1	1	No	107268	17.11	663-05810SS	145	<b>1</b>	1	No	711267	8.55
658-2002	156	1	1	No	107336	17.99	663-05812HS	146	<b>1</b>	1	No	710758	8.15
658-2004	156	1	1	No	107350	18.636	663-05812SS	145	<b>1</b>	1	No	711090	8.35
658-4004	156	1	1	No	107411	30.9261	663-05834HS	146	<b>1</b>	1	No	710840	10.05
658-4004F2	156	1	1	No	107435	32.6249	663-05834SS	145	<b>1</b>	1	No	711182	10.7

Supply

Drainage

Support

Specialties

Appendix

# Numerical Index

Supply

Drainage

Support

Specialties

Appendix

Item No	Page No	Min Qty	Case Qty	UPC Bar-Coded	UPC 6-Digit	Weight (lbs.)	Item No	Page No	Min Qty	Case Qty	UPC Bar-Coded	UPC 6-Digit	Weight (lbs.)
663-05838HS	146	1	1	No	710673	8.1	663-23834HS	146	1	1	No	710901	7.35
663-05838SS	145	1	1	No	711014	9.4	663-23834SS	145	1	1	No	711243	7.65
663-07810HS	146	1	1	No	710932	9.05	663-25810HS	146	1	1	No	710994	8.85
663-07810SS	145	1	1	No	711274	9.55	663-25810SS	145	1	1	No	711335	9.15
663-07812HS	146	1	1	No	710772	7.05	663-25812HS	146	1	1	No	710833	7.65
663-07812SS	145	1	1	No	711113	10.15	663-25812SS	145	1	1	No	711175	7.85
663-07834HS	146	1	1	No	710857	9.85	663-25812WSS	147	1	1	No	714572	-
663-07834SS	145	1	1	No	711199	10.4	663-25834HS	146	1	1	No	710918	8.35
663-07838HS	146	1	1	No	710680	6.95	663-25838HS	146	1	1	No	710734	7
663-07838SS	145	1	1	No	711021	7.3	663-25838SS	145	1	1	No	711076	7.95
663-11810HS	146	1	1	No	710949	9.2	663-31212SS	145	1	1	No	714763	7.75
663-11810SS	145	1	1	No	711281	9.85	663-31812WSS	147	1	1	No	714589	-
663-11812HS	146	1	1	No	710789	7.65	663-31838HS	146	1	1	No	714718	-
663-11812SS	145	1	1	No	711120	7.7	663-31838SS	145	1	1	No	714695	6.6
663-11834HS	146	1	1	No	710864	8.7	663-41212WSS	147	1	1	No	714596	-
663-11834SS	145	1	1	No	711205	8.7	664X2B10	11	1	1	No	455390	28
663-11838HS	146	1	1	No	710697	7.1	664X2B20	11	1	1	No	421425	55
663-11838SS	145	1	1	No	711038	7.7	664X2R10	11	1	1	No	455406	28
663-13810HS	146	1	1	No	710956	9.55	664X2R20	11	1	1	No	421418	55
663-13810SS	145	1	1	No	711298	10.2	664X2W10	11	1	1	No	455413	28
663-13812HS	146	1	1	No	710796	7.7	664X2W20	11	1	1	No	421432	55
663-13812SS	145	1	1	No	711137	8.05	664X3B10	11	1	1	No	455420	26
663-13812WSS	147	1	1	No	714558	-	664X3B20	11	1	1	No	421456	53
663-13834HS	146	1	1	No	710871	7.65	664X3H20	12	1	1	No	439154	26
663-13834SS	145	1	1	No	711212	9.45	664X3R10	11	1	1	No	455437	26
663-13838HS	146	1	1	No	710703	7.4	664X3R20	11	1	1	No	421449	55
663-13838SS	145	1	1	No	711045	7.8	664X3W10	11	1	1	No	455444	26
663-15810HS	146	1	1	No	710963	9.4	664X3W20	11	1	1	No	421463	54
663-15810SS	145	1	1	No	711304	9.9	664X4B10	11	1	1	No	712035	26
663-15812HS	146	1	1	No	710802	8.1	664X4B20	11	1	1	No	421487	52
663-15812SS	145	1	1	No	711144	8.2	664X4H20	12	1	1	No	102874	18
663-15812WSS	147	1	1	No	714565	8.75	664X4R10	11	1	1	No	712042	25.5
663-15834HS	146	1	1	No	710888	9.55	664X4R20	11	1	1	No	421470	51
663-15834SS	145	1	1	No	711229	10	664X4W10	11	1	1	No	102898	26.36
663-15838HS	146	1	1	No	710710	7.5	664X4W20	11	1	1	No	421494	51.9
663-15838SS	145	1	1	No	711052	7.8	664X5W20	11	1	1	No	421500	51.24
663-20038HS	146	1	1	No	714701	-	664X6W20	11	1	1	No	422231	59.1992
663-20038SS	145	1	1	No	714688	8.6	664X7W20	11	1	1	No	422248	3
663-21810HS	146	1	1	No	710970	9.3	664XA5W20	13	1	1	No	713599	-
663-21810SS	145	1	1	No	711311	9.8	664XA6W20	13	1	1	No	713544	56
663-21812HS	146	1	1	No	710819	7.5	664XA7W20	13	1	1	No	204769	60
663-21812SS	145	1	1	No	711151	7.9	665X0W100	11	1	1	Yes	444936	3
663-21834HS	146	1	1	No	710895	8.3	665X1W100	11	1	1	Yes	444929	4
663-21834SS	145	1	1	No	711236	8.55	665X2B100	11	1	1	Yes	421524	6
663-21838HS	146	1	1	No	710727	6.45	665X2B1000	12	1	1	Yes	421616	55
663-21838SS	145	1	1	No	711069	6.7	665X2B300	12	1	1	Yes	421555	16.5
663-23810HS	146	1	1	No	710987	9.25	665X2B500	12	1	1	Yes	421586	28
663-23810SS	145	1	1	No	711328	9.85	665X2H100	12	1	1	Yes	418074	6.29
663-23812HS	146	1	1	No	710826	7.55	665X2H1000	13	1	1	Yes	206411	54.892
663-23812SS	145	1	1	No	711168	7.75	665X2H1200	13	1	1	Yes	703842	64.15

Item No	Page No	Min Qty	Case Qty	UPC Bar-Coded	UPC 6-Digit	Weight (lbs.)	Item No	Page No	Min Qty	Case Qty	UPC Bar-Coded	UPC 6-Digit	Weight (lbs.)
665X2H300	13	1	1	Yes	102539	16.4676	665XA3N100H	14	1	1	Yes	410887	11
665X2H500	13	1	1	Yes	458261	27.446	665XA3N250	13	1	1	Yes	417725	27.5
665X2R100	11	1	1	Yes	421517	6	665XA4N100	13	1	1	Yes	417695	17.5
665X2R1000	12	1	1	Yes	421609	55	672C0242	43	1	10	Yes	499998	1.0737
665X2R300	12	1	1	Yes	421548	16.5	672C0342	43	1	10	Yes	465436	2.1985
665X2R500	12	1	1	Yes	421579	28	672C0442	43	1	10	Yes	499394	1.8872
665X2W100	11	1	1	Yes	421531	6	672CB0242	43	1	10	Yes	499400	1.9246
665X2W1000	12	1	1	Yes	421623	55	672CB0342	43	1	10	Yes	499417	2.7803
665X2W300	12	1	1	Yes	421562	16.5	672CB0442	43	1	10	Yes	499424	3.5466
665X2W500	12	1	1	Yes	421593	28	672CV0242	43	1	10	Yes	499431	1.3647
665X3B100	11	1	1	Yes	421647	11	672CV0342	43	1	10	Yes	499448	1.9538
665X3B300	12	1	1	Yes	421678	31.99	672CV0442	43	1	10	Yes	499455	2.4736
665X3B500	12	1	1	Yes	421708	53	672Q0490	141	10	10	Yes	410696	1.186
665X3H100	12	1	1	Yes	418081	13.9	672Q0499	141	10	10	Yes	410719	1.185
665X3H300	13	1	1	Yes	443366	31.5	672Q0590	141	10	10	Yes	410702	1.417
665X3H500	13	1	1	Yes	703262	-	672Q0599	141	10	10	Yes	410726	1.583
665X3R100	11	1	1	Yes	421630	11	672Q0690	141	10	10	Yes	410689	1.6105
665X3R300	12	1	1	Yes	421661	31.99	672Q0699	141	10	10	Yes	410733	1.737
665X3R500	12	1	1	Yes	421692	53	672WG0240	71	1	10	Yes	407412	0.461
665X3W100	11	1	1	Yes	421654	11	672WG0340	71	1	10	Yes	407405	0.6952
665X3W300	12	1	1	Yes	421685	32.99	672WG03C0	72	10	10	Yes	412300	1.033
665X3W500	12	1	1	Yes	421715	53	672WG0430	70	1	10	Yes	412874	1.1217
665X4B100	11	1	1	Yes	421739	17.2	672WG0440	71	1	10	Yes	407337	0.844
665X4B300	12	1	1	Yes	421760	51.6	672WG0490	70	10	10	Yes	429551	0.416
665X4B500	12	1	1	Yes	421791	86	672WG0499	70	10	10	Yes	457189	1.245
665X4H100	12	1	1	Yes	455130	19.0225	672WG04C0	72	10	10	Yes	412294	1.2053
665X4H300	13	1	1	Yes	703750	-	672WG0630	70	1	10	Yes	411938	1.5376
665X4H500	13	1	1	Yes	444394	86	672WG0640	71	1	10	Yes	407368	1.074
665X4R100	11	1	1	Yes	421722	17.2	672WG0690	70	10	10	Yes	457196	1.36
665X4R300	12	1	1	Yes	421753	51.6	672WG0699	70	10	10	Yes	457219	1.565
665X4R500	12	1	1	Yes	421784	86	672WG06C0	72	10	10	Yes	412287	1.3748
665X4W100	11	1	1	Yes	421746	17	672WG0830	70	1	10	Yes	411884	2.0439
665X4W300	12	1	1	Yes	421777	51.6	672WG0840	71	1	10	Yes	407375	2.0465
665X4W500	12	1	1	Yes	421807	84	672WG0890	70	10	10	Yes	457226	1.515
665X5W100	11	1	1	Yes	455635	25	672WG0899	70	10	10	Yes	457233	1.89
665X5W300	12	1	1	Yes	463128	75	672WG08C0	72	10	10	Yes	412270	2.1491
665X6W100	11	1	1	Yes	457264	37	672WG1040	71	1	10	Yes	407382	1.69
665X6W300	12	1	1	Yes	455642	106.2	672WG1240	71	1	10	Yes	407399	2.006
665X7W100	11	1	1	Yes	455659	60	672WGT0390	72	10	100	Yes	443977	0.01
665X8W100	11	1	1	Yes	457462	5.5	672WGT0399	73	10	100	Yes	456595	0.475
665X9H100	12	1	1	Yes	703767	8.1	672WGT0490	72	10	100	Yes	458247	0.451
665X9H1000	13	1	1	Yes	444486	76.8	672WGT0499	73	10	100	Yes	458254	0.495
665X9H300	13	1	1	Yes	703774	24.2	672WP0299	77	10	140	Yes	710505	0.065
665X9H500	13	1	1	Yes	703552	39.7325	672WP0390	77	10	140	Yes	710512	-
665XA2N100	13	1	1	Yes	417671	6	672WP0399	77	10	140	Yes	710529	-
665XA2N1000H	14	1	1	Yes	205230	56.1	672WP0490	77	10	100	Yes	710536	0.111
665XA2N250	13	1	1	Yes	417701	26.5152	672WP0499	77	10	100	Yes	710543	0.111
665XA2N300H	14	1	1	Yes	410436	18	672WP0670	77	10	60	Yes	715289	-
665XA2N500	13	1	1	Yes	417763	53.0303	672WP0677	77	10	60	Yes	715296	-
665XA3N100	13	1	1	Yes	417688	11	672WP0690	77	10	60	Yes	710550	0.1542

Supply

Drainage

Support

Specialties

Appendix

# Numerical Index

Supply

Drainage

Support

Specialties

Appendix

Item No	Page No	Min Qty	Case Qty	UPC Bar-Coded	UPC 6-Digit	Weight (lbs.)	Item No	Page No	Min Qty	Case Qty	UPC Bar-Coded	UPC 6-Digit	Weight (lbs.)
672WP0699	77	<b>10</b>	60	Yes	710567	-	672X0698	37	25	25	No	457417	0.92
672WPT0399	77	<b>10</b>	10	Yes	715302	0.1075	672X0699	36	25	25	No	405180	0.8958
672WPT0499	77	<b>10</b>	10	Yes	715319	0.095	672X0699PK	36	<b>6</b>	6	Yes	480163	0.974
672WPT0699	77	<b>10</b>	10	Yes	715326	0.1392	672X06C0	42	10	10	No	499127	1.0665
672WV0230	71	1	10	Yes	407726	1.1797	672X0790	35	25	25	No	405197	1.0226
672WV0330	71	1	10	Yes	407719	1.694	672X0830	38	25	25	No	405203	1.2822
672WV0430	71	1	10	Yes	407702	2.8388	672X0833EE	39	10	10	No	405210	1.7579
672WV0444	72	1	10	Yes	411211	2.1012	672X0840	40	25	25	No	406118	1.3394
672WV0630	71	1	10	Yes	407696	2.9185	672X0844	40	25	25	No	406125	1.4826
672WV0644	72	1	10	Yes	411228	2.8185	672X0870	37	10	10	No	497932	1.1901
672WV0830	71	1	10	Yes	407689	5.1138	672X0877	38	10	10	No	497864	1.2691
672WV0844	72	1	10	Yes	411235	3.551	672X0890	35	25	25	No	405227	1.1901
672WV1030	71	1	10	Yes	407672	4.47	672X0897	37	10	10	No	497765	1.1901
672WV1044	72	1	10	Yes	411242	4.6911	672X0899	36	25	25	No	480187	1.1901
672WV1230	71	1	4	Yes	407429	5.176	672X08C0	42	10	10	No	498830	1.3773
672X0242	41	1	10	Yes	499653	0.639	672X0930	38	25	25	No	405241	1.4109
672X0330	38	25	25	No	400772	0.6592	672X0990	35	25	25	No	405258	1.2998
672X0342	41	1	10	Yes	499660	0.8061	672X0999	36	25	25	No	405265	1.2998
672X0380	36	25	25	No	457431	0.57	672X1033EE	39	10	10	No	405272	2.0149
672X0390	35	25	25	No	405050	0.5211	672X1090	35	25	25	No	405289	1.4285
672X0390PK	35	<b>5</b>	5	Yes	402011	0.5714	672X10C0	42	10	10	No	498847	1.6374
672X0399	36	25	25	No	405067	0.5209	672X1230	38	25	25	No	405296	1.7731
672X03C0	42	10	10	No	499561	0.7305	672X1233EE	39	10	10	No	405302	3.0547
672X0430	38	25	25	No	405074	0.7324	672X1240	40	25	25	No	405319	1.7731
672X0431PK	39	<b>5</b>	5	Yes	480729	1.078	672X1244	40	25	25	No	406132	1.9955
672X0433EE	39	10	10	No	405081	1.1682	672X1270	37	10	10	No	497918	1.7832
672X0440	40	25	25	No	406071	0.8368	672X1277	38	10	10	No	497901	1.8036
672X0441PK	41	<b>5</b>	5	Yes	480828	1.0249	672X1290	35	25	25	No	480460	1.5824
672X0442	41	1	10	Yes	499677	0.9478	672X1297	37	10	10	No	498427	1.7832
672X0470	37	10	10	No	498175	0.7003	672X1299	36	25	25	No	480224	1.5858
672X0477	38	10	10	No	497826	0.7003	672X12C0	42	10	10	No	498540	1.902
672X0480	36	25	25	No	457424	0.626	672X4L-1131B3	41	5	5	Yes	405340	3.813
672X0490	35	25	25	No	480323	0.6448	672XB0242	42	1	10	Yes	499684	1.6998
672X0490PK	35	<b>5</b>	5	Yes	402059	0.6951	672XB0342	42	1	10	Yes	499691	2.4035
672X0497	37	10	10	No	497819	0.7003	672XB0442	42	1	10	Yes	499707	3.0666
672X0499	36	25	25	No	480125	0.6448	672XGT0390	43	<b>10</b>	100	Yes	442499	0.01
672X0499PK	36	<b>6</b>	6	Yes	420602	0.885	672XGT0399	44	<b>10</b>	100	Yes	443694	0.0255
672X04C0	42	10	10	No	499233	0.8368	672XGT0490	43	<b>10</b>	100	Yes	442888	0.25
672X0590	35	25	25	No	405128	0.8035	672XGT0499	44	<b>10</b>	100	Yes	443380	0.01
672X0599	36	25	25	No	405135	0.7935	672XV0242	42	1	10	Yes	499714	1.1199
672X05C0	42	10	10	No	499219	0.9398	672XV0342	42	1	10	Yes	499721	1.5234
672X0630	38	25	25	No	405142	1.0048	672XV0431PK	42	5	5	Yes	480835	1.8586
672X0633EE	39	10	10	No	405159	1.4066	672XV0442	42	1	10	Yes	499738	2.0055
672X0640	40	25	25	No	406095	1.0088	672XV0486PK	39	5	5	Yes	700650	1.41
672X0644	40	25	25	No	406101	1.2257	672XV0490	35	1	10	Yes	405357	2.113
672X0670	37	10	10	No	497987	0.9464	672XV0490PK	35	<b>5</b>	5	Yes	401670	1.9397
672X0677	38	10	10	No	497833	0.9418	672XV0499	36	1	10	Yes	405364	2.1978
672X0690	35	25	25	No	480361	0.8958	672XV0590	35	1	10	Yes	405371	2.5752
672X0690PK	35	<b>5</b>	5	Yes	402073	0.9876	672XV0599	36	1	10	Yes	405388	2.6204
672X0697	37	10	10	No	497802	0.9464	672XV0690	35	1	10	Yes	405395	2.9734



Item No	Page No	Min Qty	Case Qty	UPC Bar-Coded	UPC 6-Digit	Weight (lbs.)	Item No	Page No	Min Qty	Case Qty	UPC Bar-Coded	UPC 6-Digit	Weight (lbs.)
672XV0699	36	1	10	Yes	405401	3.1922	688-C0B	208	1	10	Yes	713537	0.06
672XV0699-2PK	36	5	5	Yes	480170	2.778	688-C0B	678	1	10	Yes	713537	0.06
672XV0810	41	1	10	Yes	405418	3.408	688-C1B	208	1	4	Yes	456458	0.2
672XV0810L	41	1	10	Yes	441737	3.9482	688-C1B	678	1	4	Yes	456458	0.2
672XV1010	41	1	10	Yes	405425	4.7564	688-F	208	10	10	No	101686	0.19
672XV1010L	41	1	10	Yes	441744	4.7564	688-G10CR	173	10	10	Yes	712226	7.75
672XV1210	41	1	4	Yes	405432	6.0507	688-G10MR	173	10	10	Yes	712233	1.605
672XV1210L	41	1	4	Yes	441751	6.1478	688-G10PR	173	10	10	Yes	714732	-
672XV1510	41	1	5	Yes	405449	7.3391	688-G10VR	173	10	10	Yes	714756	1.5
672XV1510L	41	1	5	Yes	441768	7.3824	688-G10WR	173	10	10	Yes	102966	1.635
672XV1810	41	1	5	Yes	405456	8.5368	688-G10XR	173	10	10	Yes	103000	1.63
672XV1810L	41	1	5	Yes	441775	8.5368	688-G11CR	173	10	10	Yes	712240	14.33
672XV4L-11313	42	1	5	Yes	405463	6.1294	688-G11MR	173	10	10	Yes	712257	-
675-20344	127	10	10	No	405487	0.77	688-G11PR	173	10	10	Yes	714749	-
675-20442	128	10	10	No	499769	1.1545	688-G11VR	173	10	10	Yes	714817	1.65
675-20444	127	10	10	No	405494	0.9269	688-G11WR	173	10	10	Yes	103086	1.84
675-20544	127	10	10	No	405500	1.1232	688-G11XR	173	10	10	Yes	103109	1.523
675-V20244	128	1	10	Yes	405517	1.1597	688-G1CE	207	10	10	Yes	700803	0.365
675-V20342	128	1	10	Yes	499813	1.6412	689C0101	97	12	12	Yes	481603	0.8471
675-V20344	128	1	10	Yes	405524	1.9628	689C0111	97	12	12	Yes	481559	1.0333
675-V20442	128	1	10	Yes	499479	2.0393	689C0191	98	12	12	Yes	402295	1.1371
675-V20444	128	1	10	Yes	405531	2.0576	689C1102	97	12	12	Yes	481566	1.1905
675-V20544	128	1	10	Yes	405548	1.179	689C1112	97	12	12	Yes	481610	1.3558
67745L-08334	127	1	5	Yes	405555	4.6767	689C3103	98	12	12	Yes	481627	1.768
678-20242	126	10	10	Yes	405562	0.4528	689VG2201	83	12	12	Yes	413093	0.8564
678-20342	126	10	10	Yes	405579	0.567	689VG2211	83	12	12	Yes	413161	1.0418
678-20344	126	10	10	Yes	405586	0.5374	689VG3202	83	12	12	Yes	413178	1.2191
678-20442	126	10	10	Yes	405593	0.708	689VG3212	83	12	12	Yes	413185	1.3769
678-20644	126	10	10	Yes	405609	1.0808	689WG2201	68	12	12	Yes	408327	0.812
678-21244	126	10	10	No	405616	1.719	689WG2211	68	12	12	Yes	408334	1.0218
6784L-11313	126	5	5	Yes	405623	3.1345	689WG2291	69	12	12	Yes	408341	0.7496
6795L-12333	126	1	5	Yes	405630	4.6994	689WG3202	68	12	12	Yes	408358	1.2634
6796L-12333	127	1	5	Yes	405647	5.6333	689WG3212	68	12	12	Yes	408365	1.4207
6797L-12333	127	1	4	Yes	405654	7.24	689WG5103	69	12	12	Yes	408426	1.8165
685-C2	91	20	20	No	497185	0.1073	689X2101	33	12	12	Yes	481658	0.6917
685-C3	91	20	20	No	496928	0.1634	689X2111	33	12	12	Yes	481665	0.9038
685-C4	91	20	20	No	497024	0.2545	689X2201	33	12	12	Yes	481672	0.8454
685-C5	91	10	10	No	497079	0.5275	689X2211	33	12	12	Yes	407580	0.9354
685-C6	91	5	5	No	497758	0.6591	689X2291	34	12	12	Yes	401953	0.7113
685-C7	91	5	5	No	497314	1.0472	689X3102	33	12	12	Yes	483652	0.935
685-P3	106	20	20	No	497734	0.185	689X3112	33	12	12	Yes	481993	1.2398
685-P4	106	20	20	No	497628	0.2718	689X3202	33	12	12	Yes	481986	1.01
685-P5	106	10	10	No	497512	0.5442	689X3212	33	12	12	Yes	481979	1.3162
685-P6	106	5	5	No	497383	0.6743	689X5103	34	12	12	Yes	481962	1.5278
685-P7	106	5	5	No	410467	1.0218	692-1308	122	25	25	No	405807	0.5756
687-3SFMH	120	5	5	Yes	735713	-	693-01024102	97	1	12	Yes	405814	2.3871
687-3SMFH	120	5	5	Yes	713087	-	693-06024203	97	12	12	Yes	405845	3.5917
687-3SMKIT	120	5	5	Yes	713100	-	693-13155301	129	12	12	Yes	495488	3.3162
687-3SMMH	120	5	5	Yes	713094	-	693-13755301	129	1	12	Yes	411310	3.2962
688-1	207	10	10	No	100993	0.71	694CG311120	98	1	10	Yes	421906	1.2805

Supply

Drainage

Support

Specialties

Appendix

# Numerical Index

Supply

Drainage

Support

Specialties

Appendix

Item No	Page No	Min Qty	Case Qty	UPC Bar-Coded	UPC 6-Digit	Weight (lbs.)	Item No	Page No	Min Qty	Case Qty	UPC Bar-Coded	UPC 6-Digit	Weight (lbs.)
694CG33012091	98	10	10	Yes	412171	2.617	<b>696-11A</b>	453	1	6	Yes	100665	0.8133
694CG33012093	98	10	10	Yes	412188	2.486	<b>696-11P</b>	203	1	6	Yes	100672	0.9167
694CG331220	98	10	10	Yes	412317	2.1997	<b>696-11P</b>	452	1	6	Yes	100672	0.9167
694CG36012092	98	10	10	Yes	415783	3.1222	<b>696-12A</b>	203	1	6	Yes	100689	0.8167
694CG36012094	98	1	10	Yes	412201	2.9653	<b>696-12A</b>	453	1	6	Yes	100689	0.8167
694CG361520	98	10	10	Yes	412324	2.5516	<b>696-12P</b>	203	1	6	Yes	100696	0.875
694CG565120	98	10	10	Yes	421937	2.5119	<b>696-12P</b>	452	1	6	Yes	100696	0.875
694-G21012091	129	1	10	Yes	413369	1.4818	<b>696-1F</b>	208	<b>10</b>	10	No	109323	0.1418
694Q312620	140	10	10	Yes	421913	1.3847	<b>696-1F</b>	453	<b>10</b>	10	No	109323	0.1418
694Q464120	140	10	10	Yes	421920	16.9	<b>696-2</b>	207	<b>10</b>	10	No	109330	0.4211
694WG71022091	69	10	10	Yes	410245	1.8186	<b>696-2313CF</b>	169	10	10	Yes	109484	2.66
694XG32012091	34	10	10	Yes	406675	2.7754	<b>696-2313CR</b>	169	10	10	Yes	109491	2.4985
694XG32012093	34	10	10	Yes	413079	2.385	<b>696-2313ER</b>	169	10	10	Yes	728920	2.6504
694XG322120	34	10	10	Yes	413062	2.3152	<b>696-2313MF</b>	169	10	10	Yes	109521	2.784
695-01	161	1	24	Yes	109002	1.3595	<b>696-2313MFPK4</b>	169	4	4	Yes	153951	3.3789
695-2A	162	1	10	Yes	309280	0.3694	<b>696-2313MR</b>	169	10	10	Yes	109538	2.6624
695-2A	341	1	10	Yes	309280	0.3694	<b>696-2313VF</b>	169	10	10	Yes	154194	2.45
695-2P	162	1	10	Yes	309297	0.4654	<b>696-2313WF</b>	169	10	10	Yes	109545	2.8
695-2P	341	1	10	Yes	309297	0.4654	<b>696-2313WR</b>	169	10	10	Yes	109552	2.7624
695-3A	162	1	10	No	309303	0.7254	<b>696-2313XF</b>	169	10	10	Yes	109569	2.59
695-3A	341	1	10	No	309303	0.7254	<b>696-2313XR</b>	169	10	10	Yes	109576	2.6504
695-3P	162	1	10	Yes	309310	0.873	<b>696-2413CF</b>	171	10	10	Yes	410634	1.7
695-3P	341	1	10	Yes	309310	0.873	<b>696-2413MF</b>	171	10	10	Yes	101099	1.7128
695-4A	162	1	10	No	309327	0.9508	<b>696-2413WF</b>	171	10	10	Yes	101105	1.7393
695-4A	341	1	10	No	309327	0.9508	<b>696-2413XF</b>	171	10	10	Yes	410641	1.94
695-4P	162	1	10	Yes	309334	1.3308	<b>696-2F</b>	208	<b>10</b>	10	No	109583	0.2495
695-4P	341	1	10	Yes	309334	1.3308	<b>696-3</b>	207	<b>10</b>	10	No	109590	0.4529
695-D20	161	1	16	Yes	109019	0.654	<b>696-3F</b>	207	<b>10</b>	10	No	109132	0.5534
695-D30	161	1	16	Yes	109026	0.7493	<b>696-4</b>	207	<b>10</b>	10	No	101051	0.3944
695-D40	161	1	16	Yes	109033	0.4628	<b>696-5</b>	207	<b>10</b>	10	No	154415	0.4142
695-D432	161	1	16	Yes	109040	0.4628	<b>696-6</b>	207	<b>10</b>	10	No	154422	0.4082
695-D4325	161	1	16	Yes	109057	0.4628	<b>696-7</b>	207	<b>10</b>	10	No	154439	0.4042
695-D432F	161	1	10	Yes	105042	0.8392	<b>696-7</b>	453	<b>10</b>	10	No	154439	0.4042
695-ER05	163	<b>1</b>	1	Yes	412577	9.78	<b>696-BC</b>	208	<b>10</b>	10	No	109606	0.2785
695-ER10	163	<b>1</b>	1	Yes	412584	11.56	<b>696-C3</b>	208	<b>10</b>	10	Yes	154262	0.1574
695-ER15	163	<b>1</b>	1	Yes	412591	16.34	<b>696-CF</b>	208	<b>10</b>	10	Yes	109972	0.1882
695-ER20	163	<b>1</b>	1	Yes	412607	17.62	<b>696-EX</b>	208	<b>10</b>	10	No	110312	0.0987
695-ER30	163	<b>1</b>	1	Yes	412614	19.18	<b>696-G1000CF</b>	181	10	10	Yes	100009	1.2
695-ES01	163	<b>1</b>	1	Yes	412676	3	<b>696-G1000CR</b>	181	10	10	Yes	412409	1.13
695-ES05	162	<b>1</b>	1	Yes	412621	7.23	<b>696-G1000MF</b>	181	10	10	Yes	100016	1.2
695-ES10	162	<b>1</b>	1	Yes	412638	8.76	<b>696-G1000MFPK4</b>	181	5	5	Yes	137128	1.2
695-ES15	162	<b>1</b>	1	Yes	412645	9.54	<b>696-G1000MR</b>	181	10	10	Yes	412416	1.2001
695-ES20	162	<b>1</b>	1	Yes	412652	10.82	<b>696-G1000PF</b>	181	10	10	Yes	702654	-
695-ES30	162	<b>1</b>	1	Yes	412669	12.38	<b>696-G1000VF</b>	181	10	10	Yes	101594	1.0895
695-Y52	161	1	10	Yes	109064	0.4941	<b>696-G1000WF</b>	181	10	10	Yes	100023	1.3
696-1	207	<b>10</b>	10	No	109071	0.4322	<b>696-G1000WR</b>	181	10	10	Yes	101334	0.951
696-1020GF	199	6	6	Yes	154354	1.6133	<b>696-G1000XF</b>	181	10	10	Yes	100030	0.6276
696-1021GF	199	6	6	Yes	154361	1.6133	<b>696-G1000XFS</b>	181	10	10	Yes	101242	1.4705
696-1031GF	199	6	6	Yes	154378	2.0762	<b>696-G1000XR</b>	181	10	10	Yes	412423	0.76
696-11A	203	1	6	Yes	100665	0.8133	<b>696-G1001CF</b>	185	10	10	Yes	100047	1.2294

Item No	Page No	Min Qty	Case Qty	UPC Bar-Coded	UPC 6-Digit	Weight (lbs.)	Item No	Page No	Min Qty	Case Qty	UPC Bar-Coded	UPC 6-Digit	Weight (lbs.)
696-G1001CR	185	10	10	Yes	101457	1.1422	696-G2303PF	169	10	10	Yes	702760	2.15
696-G1001MF	185	10	10	Yes	100054	1.3132	696-G2303PR	170	<b>1</b>	10	Yes	734105	2.17
696-G1001MR	185	10	10	Yes	101556	0.91	696-G2303VF	169	10	10	Yes	101600	2.3355
696-G1001PF	185	10	10	Yes	702883	0.985	696-G2303VR	170	<b>10</b>	10	Yes	734112	2.05
696-G1001VF	185	10	10	Yes	101815	-	696-G2303WF	169	10	10	Yes	100290	2.5
696-G1001WF	185	10	10	Yes	100061	1.2941	696-G2303WR	170	10	10	Yes	102065	2.2891
696-G1001WR	185	10	10	Yes	101549	0.9853	696-G2303XF	169	10	10	Yes	100306	2.408
696-G1001XF	185	10	10	Yes	100078	0.86	696-G2303XR	170	10	10	Yes	102010	2.052
696-G1001XR	185	10	10	Yes	101532	1.0667	696-G2313CF	169	10	10	Yes	100320	2.66
696-G1010CF	181	10	10	Yes	100085	0.53	696-G2313CR	169	10	10	Yes	700100	2.548
696-G1010CR	181	10	10	Yes	700094	1.312	696-G2313ER	169	<b>10</b>	10	Yes	734129	2.485
696-G1010MF	181	10	10	Yes	100092	1.4032	696-G2313MF	169	10	10	Yes	100344	2.784
696-G1010MR	181	10	10	Yes	412331	1.3184	696-G2313MR	169	<b>1</b>	10	Yes	734136	2.3
696-G1010PF	181	10	30	Yes	101945	1.327	696-G2313PF	169	10	10	Yes	102362	-
696-G1010PR	181	<b>10</b>	10	Yes	708755	0.99	696-G2313PR	169	<b>10</b>	10	Yes	708762	2.22
696-G1010VF	181	10	10	Yes	101648	1.327	696-G2313VF	169	10	10	Yes	101662	2.635
696-G1010VR	181	10	10	Yes	102751	0.9	696-G2313VR	169	10	10	Yes	102768	-
696-G1010WF	181	10	10	Yes	100115	1.392	696-G2313WF	169	10	10	Yes	100368	2.8
696-G1010WR	181	10	10	Yes	101310	1.1455	696-G2313WR	169	10	10	Yes	102041	2.3924
696-G1010XF	181	10	10	Yes	100122	1.3042	696-G2313XF	169	10	10	Yes	100375	2.79
696-G1010XFS	181	10	10	Yes	101259	1.629	696-G2313XR	169	10	10	Yes	734655	-
696-G1010XR	181	10	10	Yes	412430	0.6271	696-G2403CF	171	10	10	Yes	101969	1.245
696-G1011CF	185	10	10	Yes	100139	1.358	696-G2403MF	171	10	10	Yes	101976	1.7655
696-G1011MF	185	10	10	Yes	100146	1.4838	696-G2403WF	171	10	10	Yes	101983	1.5305
696-G1011PF	185	10	30	Yes	102775	-	696-G2403XF	171	10	10	Yes	700162	1.8008
696-G1011VF	185	10	10	Yes	102126	-	696-G2413CF	171	10	30	Yes	103475	-
696-G1011WF	185	10	10	Yes	100153	0.8687	696-G2413MF	171	<b>10</b>	10	Yes	103147	1.68
696-G1011XF	185	10	10	Yes	100160	0.7887	696-G2413VF	171	10	10	Yes	733511	1.8798
696-G1013XF	177	10	30	Yes	101754	1.2145	696-G2413WF	171	10	10	Yes	102058	1.8798
696-G2001CF	189	10	10	Yes	100177	1.7349	696-G2413XF	171	10	10	Yes	458278	1.55
696-G2001CR	189	10	10	Yes	101464	1.6295	696-G3011CR	195	10	10	Yes	102379	1.63
696-G2001MF	189	10	10	Yes	100184	1.8442	696-G3011MR	195	10	10	Yes	462466	-
696-G2001MR	189	10	10	Yes	101525	1.6864	696-G3011PR	195	10	30	Yes	702456	-
696-G2001PF	189	10	10	Yes	702753	1.34	696-G3011VR	195	10	30	Yes	700179	-
696-G2001PR	189	<b>10</b>	10	Yes	708915	1.235	696-G3011WR	195	10	10	Yes	102386	1.95
696-G2001VF	189	10	10	Yes	101839	1.7474	696-G3011XR	195	10	10	Yes	102393	1.91
696-G2001WF	189	10	10	Yes	100191	1.823	696-G3014CR	195	10	30	Yes	702661	-
696-G2001WR	189	10	10	Yes	101518	1.6745	696-G3014MR	195	10	30	Yes	702678	-
696-G2001XF	189	10	10	Yes	100207	1.821	696-G3014PR	195	10	30	Yes	702685	-
696-G2001XR	189	10	10	Yes	101501	1.6008	696-G3014WR	195	10	30	Yes	702609	-
696-G2011CF	189	10	10	Yes	100214	2.0704	696-G3014XR	195	10	30	Yes	702623	-
696-G2011MF	189	10	10	Yes	100221	2.2866	696-G3021CR	195	10	30	Yes	702241	-
696-G2011VF	189	10	10	Yes	101181	-	696-G3021MR	195	10	30	Yes	702258	-
696-G2011WF	189	10	10	Yes	100238	1.0526	696-G3021WR	195	10	10	Yes	700957	1.645
696-G2011XF	189	10	10	Yes	100245	1.0526	696-G3021XR	195	10	30	Yes	702272	-
696-G2303CF	169	10	10	Yes	100252	2.216	696-G3024CR	195	10	30	Yes	702487	-
696-G2303CR	170	10	10	Yes	101471	2.066	696-G3024MR	195	10	30	Yes	702548	-
696-G2303ER	170	10	10	Yes	734099	2.27	696-G3024WR	195	10	30	Yes	702470	-
696-G2303MF	169	10	10	Yes	100276	2.414	696-G3024XR	195	10	30	Yes	702463	0.9253
696-G2303MR	170	10	10	Yes	102102	2.04	696-G4021CR	195	10	10	Yes	702524	-

Supply

Drainage

Support

Specialties

Appendix

# Numerical Index

Supply

Drainage

Support

Specialties

Appendix

Item No	Page No	Min Qty	Case Qty	UPC Bar-Coded	UPC 6-Digit	Weight (lbs.)	Item No	Page No	Min Qty	Case Qty	UPC Bar-Coded	UPC 6-Digit	Weight (lbs.)
696-G4021MR	195	10	30	Yes	702562	-	696RG2303MF	170	10	10	Yes	100573	2.875
696-G4021PR	195	10	30	Yes	702579	-	696RG2303VF	170	10	10	Yes	101617	2.9905
696-G4021WR	195	10	30	Yes	702586	-	696RG2303WF	170	10	10	Yes	100580	2.2147
696-G4021XR	195	10	30	Yes	703002	-	696RG2303XF	170	10	10	Yes	100597	2.8375
696-G4024CR	196	10	10	Yes	702531	-	696RG2313CF	170	10	10	Yes	100603	2.8233
696-G4024MR	196	10	30	Yes	702890	-	696RG2313MF	170	10	10	Yes	100610	3.1837
696-G4024PR	196	10	30	Yes	702616	-	696RG2313PF	170	10	30	Yes	102416	2.9783
696-G4024WR	196	10	30	Yes	702906	-	696RG2313VF	170	10	10	Yes	102003	2.6
696-G4024XR	196	10	30	Yes	702630	-	696RG2313WF	170	10	10	Yes	100627	3.2558
696-LC	208	<b>10</b>	10	No	153470	0.0951	696RG2313XF	170	10	10	Yes	100634	3.2058
696-LC	453	<b>10</b>	10	No	153470	0.0951	696RG2403CF	171	<b>10</b>	10	Yes	707970	1.475
696-PN	208	<b>50</b>	50	No	109798	0.0092	696RG2403WF	171	10	10	Yes	709868	-
696R1020GF	199	10	10	Yes	154385	1.451	696RG2413WF	171	10	10	Yes	102904	2.218
696R1021GF	199	10	10	Yes	154392	1.8168	696RG3011PF	196	10	10	Yes	722553	-
696R1031GF	199	10	10	Yes	154408	2.1842	696RG3011VF	196	<b>10</b>	10	Yes	728111	-
696R2313CF	170	10	10	Yes	110268	2.8233	696RG3011WF	196	10	10	Yes	102492	2.22
696R2313MF	170	10	10	Yes	110282	3.1837	696RG3011XF	196	10	10	Yes	462503	1.885
696R2313VF	170	10	10	Yes	700001	3.4542	696RG3021WF	196	10	30	Yes	711397	0.7591
696R2313WF	170	10	10	Yes	110299	3.2558	696RG4021MF	196	10	30	Yes	723130	0.7591
696R2313XF	170	10	10	Yes	110305	2.9151	696RG4021WF	196	10	30	Yes	708359	0.7591
696R3	207	10	10	Yes	153500	0.9906	696RG4024XF	196	<b>10</b>	10	Yes	714244	-
696RG1000CF	182	10	10	Yes	100399	1.1869	696-SC	208	<b>10</b>	10	No	153487	0.0926
696RG1000MF	182	10	10	Yes	100405	1.1869	696-SC1	208	<b>10</b>	10	No	101044	0.0775
696RG1000VF	182	10	10	Yes	101624	1.265	696-T2001CR	190	<b>1</b>	1	Yes	734693	-
696RG1000WF	182	10	10	Yes	100412	1.376	696-T2001PR	190	<b>1</b>	1	Yes	734709	-
696RG1000XF	182	10	10	Yes	100429	0.8497	696-T2001WR	190	<b>1</b>	1	Yes	734716	-
696RG1001CF	186	10	10	Yes	100436	1.3946	696-T2001XR	190	<b>1</b>	1	Yes	734648	-
696RG1001MF	186	10	10	Yes	100443	1.3946	697-1FL	208	10	10	No	202741	0.505
696RG1001VF	186	10	30	Yes	101846	-	698-A11APR	190	10	10	Yes	103215	1.93
696RG1001WF	186	10	10	Yes	101235	1.223	698-A11AWR	190	10	10	Yes	103222	1.88
696RG1001XF	186	10	10	Yes	100450	1.3946	698-A11AXR	190	10	10	Yes	103239	1.9
696RG1010CF	182	10	10	Yes	100467	1.3636	698-A11-MR	190	10	10	Yes	103185	1.735
696RG1010MF	182	10	10	Yes	100474	1.1873	698-A11-PR	190	10	10	Yes	103192	1.695
696RG1010PF	182	10	30	Yes	102409	1.4915	698-A11-VR	190	10	10	Yes	711908	-
696RG1010VF	182	10	10	Yes	101136	1.4785	698-A11-WR	190	10	10	Yes	103208	1.695
696RG1010WF	182	10	10	Yes	100481	1.1873	698-A11-XR	190	10	10	Yes	103154	1.68
696RG1010XF	182	10	10	Yes	100498	0.9497	698-A33ACR	172	10	10	Yes	103291	2.06
696RG1011CF	185	10	30	Yes	102263	1.325	698-A33AMR	172	10	10	Yes	103307	2.025
696RG1011MF	185	10	30	Yes	102034	1.4374	698-A33APR	172	10	10	Yes	103314	2.02
696RG1011XF	185	10	30	Yes	101563	1.0503	698-A33AWR	172	10	10	Yes	103321	2.015
696RG2001CF	190	10	10	Yes	100528	1.8716	698-A33AXR	172	10	10	Yes	103338	2.005
696RG2001MF	190	10	10	Yes	100535	1.8716	698-A33-CR	172	10	10	Yes	103246	1.84
696RG2001PF	190	10	10	Yes	702777	1.5	698-A33-MR	172	10	10	Yes	103253	1.815
696RG2001VF	190	10	10	Yes	101891	1.0064	698-A33-PR	172	10	10	Yes	103260	1.79
696RG2001WF	190	10	10	Yes	100542	1.9591	698-A33-WR	172	10	10	Yes	103277	1.775
696RG2001XF	190	10	10	Yes	100559	1.8716	698-A33-XR	172	10	10	Yes	103284	1.77
696RG2011CF	189	<b>10</b>	30	Yes	100870	2.0622	698-DC	207	24	24	No	101433	0.2417
696RG2011VF	189	10	30	Yes	726346	-	698-EX	208	<b>10</b>	10	No	700339	0.115
696RG2011XF	189	10	30	Yes	700971	-	698-F	208	<b>10</b>	10	No	103161	0.195
696RG2303CF	170	10	10	Yes	100566	2.2147	698RA11APR	191	10	10	Yes	705945	1.1225

Item No	Page No	Min Qty	Case Qty	UPC Bar-Coded	UPC 6-Digit	Weight (lbs.)	Item No	Page No	Min Qty	Case Qty	UPC Bar-Coded	UPC 6-Digit	Weight (lbs.)
698RA11AWR	191	10	10	Yes	705990	1.1225	699RA1-WR	186	10	10	Yes	706850	0.75
698RA11AXR	191	10	10	Yes	705983	1.1225	699RA1-XR	186	10	10	Yes	706867	-
698RA11-CR	191	10	10	Yes	705938	0.9225	699RF	208	<b>10</b>	10	No	700353	0.095
698RA11-MR	191	10	10	Yes	705693	2.005	700-0	779	<b>12</b>	120	No	507044	0.075
698RA11-PR	191	10	10	Yes	705969	0.9225	700-1	779	<b>12</b>	120	No	507051	0.08
698RA11-VR	191	<b>10</b>	10	Yes	713407	-	700-2	779	<b>12</b>	120	No	507068	0.0815
698RA11-WR	191	10	10	Yes	705976	0.9225	700-3	779	<b>12</b>	120	No	403735	0.096
698RA11-XR	191	10	10	Yes	705952	0.9225	700-4	779	<b>12</b>	120	No	403742	0.0927
698RA33ACR	172	10	10	Yes	706089	1.1225	700-5	779	<b>6</b>	60	No	507099	0.111
698RA33AMR	172	10	10	Yes	706201	1.1225	700-6	779	<b>6</b>	60	No	507105	0.1098
698RA33APR	172	10	10	Yes	706218	1.1225	700-7	779	<b>6</b>	60	No	507112	0.1167
698RA33AWR	172	10	10	Yes	706225	1.1225	702-2	779	<b>24</b>	240	No	507150	0.053
698RA33AXR	172	10	10	Yes	706232	1.1225	702-3	779	<b>24</b>	240	No	507167	0.055
698RA33-CR	172	10	10	Yes	706096	0.9225	702-4	779	<b>24</b>	240	No	507174	0.064
698RA33-MR	172	10	10	Yes	706171	0.9225	703-2	779	<b>24</b>	240	No	507181	0.054
698RA33-PR	172	10	10	Yes	706164	0.9225	703-3	779	<b>24</b>	240	No	507198	0.056
698RA33-WR	172	10	10	Yes	706188	0.9225	703-4	779	<b>24</b>	240	No	507204	0.063
698RA33-XR	172	10	10	Yes	706195	0.9225	703-5	779	<b>12</b>	120	No	507211	0.0793
698RF	208	<b>10</b>	10	Yes	700346	0.32	703-6	779	<b>6</b>	60	No	507228	0.1008
698-VC	208	<b>50</b>	50	No	437303	0.011	703-7	779	<b>6</b>	60	No	507235	0.109
699-A0-CR	182	10	10	Yes	103383	0.745	704-2	779	<b>12</b>	72	No	507242	0.096
699-A0-MR	182	10	10	Yes	103345	0.735	704-3	779	<b>12</b>	72	No	507259	0.096
699-A0-PR	182	10	10	Yes	103352	0.72	704-4	779	<b>12</b>	72	No	507266	0.1083
699-A0-VR	182	<b>10</b>	30	Yes	709066	-	705-2	779	<b>12</b>	120	No	507273	0.11
699-A0-WR	182	10	10	Yes	103369	0.715	705-3	779	<b>12</b>	120	No	507280	0.127
699-A0-XR	182	10	10	Yes	103376	0.72	705-4	779	<b>12</b>	120	No	507297	0.122
699-A1-CR	186	10	10	Yes	103390	0.75	706-2	779	<b>12</b>	72	No	507303	0.042
699-A1ECR	186	10	10	Yes	702388	0.875	706-3	779	<b>12</b>	72	No	507310	0.0726
699-A1EMR	186	10	10	Yes	702395	0.855	706-4	779	<b>12</b>	72	No	507327	0.077
699-A1EPR	186	10	10	Yes	702401	0.83	707-2	779	<b>12</b>	72	No	507334	0.0681
699-A1EVR	186	10	10	Yes	714022	0.81	707-3	779	<b>12</b>	72	No	509505	0.0712
699-A1EWR	186	10	10	Yes	702449	0.82	707-4	779	<b>12</b>	72	No	507358	0.0738
699-A1EXR	186	10	10	Yes	702340	0.825	710-2	780	<b>6</b>	120	No	404022	0.058
699-A1-MR	186	10	10	Yes	103406	0.735	710-3	780	<b>6</b>	120	No	404039	0.0573
699-A1-PR	186	10	10	Yes	103413	0.715	710-4	780	<b>6</b>	120	No	507389	0.1038
699-A1-VR	186	<b>10</b>	30	Yes	709073	-	730-05	780	<b>1</b>	24	Yes	405968	0.308
699-A1-WR	186	10	10	Yes	460738	0.77	730-10	780	<b>1</b>	24	Yes	403025	0.568
699-A1-XR	186	<b>10</b>	10	Yes	402363	0.735	730-25	780	<b>1</b>	12	Yes	405975	1.1
699-A3-MR	177	<b>10</b>	10	Yes	700735	0.775	740-02	780	<b>1</b>	50	Yes	406019	0.084
699-A3-PR	177	<b>10</b>	10	Yes	700742	0.75	740-05	780	<b>1</b>	24	Yes	405982	0.236
699-A3-WR	177	<b>10</b>	10	Yes	700759	0.755	740-10	780	<b>1</b>	24	Yes	403056	0.426
699-A3-XR	177	<b>10</b>	10	Yes	700766	0.74	740-25	780	<b>1</b>	12	Yes	405951	1.1971
699-DC	207	<b>10</b>	10	No	437310	0.1	743-05	780	<b>1</b>	24	Yes	405999	0.364
699-FC	208	10	200	Yes	201065	0.1312	743-10	780	<b>1</b>	24	Yes	403353	0.568
699RA1EMR	186	10	30	Yes	708083	-	743-25	780	<b>1</b>	12	Yes	406002	1.0817
699RA1EPR	186	10	30	Yes	708113	-	750-46	780	<b>1</b>	14	No	507495	0.3029
699RA1EWR	186	10	10	Yes	708090	0.85	750-69	780	<b>1</b>	12	No	507501	0.358
699RA1EXR	186	10	10	Yes	708106	0.85	752-69	780	<b>1</b>	12	No	507518	0.3797
699RA1-MR	186	10	30	Yes	706928	-	771	779	<b>1</b>	12	No	507525	2.194
699RA1-PR	186	10	30	Yes	706935	-	772	779	<b>1</b>	12	No	507532	2.433

Supply

Drainage

Support

Specialties

Appendix

# Numerical Index

Supply

Drainage

Support

Specialties

Appendix

Item No	Page No	Min Qty	Case Qty	UPC Bar-Coded	UPC 6-Digit	Weight (lbs.)	Item No	Page No	Min Qty	Case Qty	UPC Bar-Coded	UPC 6-Digit	Weight (lbs.)
773	779	<b>36</b>	360	No	507549	0.036	820-T20PKR	414	6	6	Yes	725578	-
774	779	<b>36</b>	36	No	507556	0.0292	820-T20PRBQ	414	6	6	Yes	725608	-
776	779	<b>24</b>	24	No	507563	0.071	820-T20PRBR	414	6	6	Yes	725615	-
777	779	<b>24</b>	24	No	507570	0.079	820-T27P	414	10	10	Yes	725158	0.655
800-A	427	<b>12</b>	12	Yes	300102	2.1502	820-T27PQ	414	10	10	Yes	725165	-
800-ABW	427	12	12	Yes	300133	2.2107	820-T2P	414	10	10	Yes	725097	0.66
800-AIR	427	1	2	Yes	375063	4.2985	821-200A	407	<b>20</b>	20	Yes	300140	0.6748
800-ANQ	427	1	2	Yes	375094	5.2478	821-200ACQ	409	1	5	Yes	312280	1.96
800-ANR	427	1	2	Yes	356208	4.9642	821-200ACR	409	5	5	Yes	312273	1.7
800-APK	427	3	3	Yes	300102	2.3985	821-200AKQ	410	<b>1</b>	5	Yes	325563	1.5747
800-ASQ	427	1	2	Yes	310118	-	821-200AKR	410	5	5	Yes	325570	1.26
800-ASR	427	1	2	Yes	310125	3.7704	821-200ANQ	408	1	5	Yes	356376	1.7308
800-P	427	12	12	Yes	300089	2.7111	821-200ANR	408	5	5	Yes	301932	1.5504
800-PBW	427	12	12	Yes	300157	2.8021	821-200ARBQ	411	1	5	Yes	352316	1.762
800-PIR	427	1	2	Yes	375087	4.8594	821-200ARBR	411	1	5	Yes	352323	1.5616
800-PNQ	427	1	2	Yes	375148	3.3687	821-200ASQ	410	1	5	Yes	307378	1.96
800-PNR	427	1	2	Yes	306760	5.7168	821-200ASR	410	5	5	Yes	307385	1.7
800-PPK	427	3	3	Yes	300089	3.0578	821-200P	407	<b>20</b>	20	Yes	300171	0.9245
800-PSQ	427	1	1	Yes	310132	5.295	821-200PCQ	409	1	5	Yes	312266	2.09
800-PSR	427	1	1	Yes	310149	4.125	821-200PCR	409	5	5	Yes	312242	1.18
801-A	432	1	25	Yes	300096	0.329	821-200PKQ	410	1	5	Yes	324597	1.67
801-A2	432	1	25	Yes	380180	0.2293	821-200PKR	410	5	5	Yes	324580	1.485
801-APK	432	10	10	Yes	300348	0.3075	821-200PNQ	408	1	5	Yes	301963	1.875
801-DR2	432	1	10	Yes	380173	1.5251	821-200PNR	408	5	5	Yes	301925	1.7604
801-NQ2	432	1	10	Yes	380166	2.4745	821-200PRBQ	411	1	5	Yes	352330	1.94
801-NR2	432	1	10	Yes	380197	1.3047	821-200PRBR	411	1	5	Yes	352347	1.7749
801-P	432	1	25	Yes	300126	0.334	821-200PSQ	410	1	5	Yes	307392	2.09
801-P2	432	1	25	Yes	380159	0.2293	821-200PSR	410	5	5	Yes	307422	1.85
801-P2PK	432	10	10	Yes	380159	0.2224	821-270A	407	<b>20</b>	20	Yes	351562	0.6928
801-PG2	432	1	25	Yes	309273	0.2256	821-270AQ	407	<b>20</b>	20	Yes	318510	0.9075
801-PPK	432	10	10	Yes	300324	0.3121	821-270P	407	<b>20</b>	20	Yes	300249	1.2815
801-SQ2	432	1	10	Yes	309204	2.37	821-270PQ	407	20	20	Yes	318527	1.253
801-SR2	432	1	10	Yes	309198	1.178	821-2A	407	20	20	Yes	300416	0.6806
802-7	427	12	12	Yes	300027	0.1625	821-2ACP	412	1	5	Yes	300331	1.687
803-2PK2	448	12	12	Yes	300058	0.2423	821-2APK	407	8	8	Yes	378323	0.6685
803-3PK2	448	12	12	Yes	300065	0.5934	821-2AQCP	412	1	5	Yes	381200	1.93
803-4PK2	448	12	12	Yes	300072	1.086	821-2AQRB	412	1	5	Yes	309617	1.842
819-2P	421	<b>6</b>	6	Yes	734914	-	821-2AT4A	413	<b>1</b>	5	Yes	325310	0.88
820-20PCQ	414	6	6	Yes	725462	-	821-2AT5A	413	1	5	Yes	325464	1.06
820-20PCR	414	6	6	Yes	725455	-	821-2ATQ	413	1	1	Yes	322807	1.7525
820-20PKQ	414	6	6	Yes	725479	-	821-2IFS	416	4	4	Yes	375223	4.05
820-20PKR	414	6	6	Yes	725486	-	821-2IH	416	1	10	Yes	318602	3.985
820-20PRBQ	414	6	6	Yes	725493	-	821-2IHCP	416	1	5	Yes	318619	1.4512
820-20PRBR	414	6	6	Yes	725509	-	821-2IHQCP	416	1	5	Yes	318626	5.523
820-27P	414	20	20	Yes	725103	-	821-2INS	416	1	4	Yes	378309	4.4375
820-27PQ	414	20	20	Yes	725110	-	821-2IT	416	1	10	Yes	318633	4.735
820-2P	414	20	20	Yes	725080	-	821-2ITCP	416	1	5	Yes	318640	0.9912
820-T20PCQ	414	6	6	Yes	725547	-	821-2ITQCP	416	1	5	Yes	318657	0.01
820-T20PCR	414	6	6	Yes	725554	-	821-2LCQ	409	1	5	Yes	319128	1.0702
820-T20PKQ	414	6	6	Yes	725561	-	821-2LCR	409	1	5	Yes	319111	0.84

Item No	Page No	Min Qty	Case Qty	UPC Bar-Coded	UPC 6-Digit	Weight (lbs.)	Item No	Page No	Min Qty	Case Qty	UPC Bar-Coded	UPC 6-Digit	Weight (lbs.)
821-2LKQ	410	1	5	Yes	325587	0.9902	821-EX2	410	1	10	Yes	327536	0.135
821-2LKR	410	<b>1</b>	5	Yes	325600	0.7802	821-EX2	411	1	10	Yes	327536	0.135
821-2LNQ	408	1	5	Yes	319067	1.4459	821-EX2	411	1	10	Yes	327536	0.135
821-2LNR	408	1	5	Yes	319050	0.9573	821-EX2	412	1	10	Yes	327536	0.135
821-2LQRB	412	1	5	Yes	319234	1.1805	821-EX2	413	1	10	Yes	327536	0.135
821-2LRBQ	411	1	5	Yes	319142	2.246	821-EX2	416	1	10	Yes	327536	0.135
821-2LRBR	411	1	5	Yes	319104	0.8	821-EX2	417	1	10	Yes	327536	0.135
821-2LSNQ	408	<b>10</b>	10	Yes	331120	0.3589	821-EX2	418	1	10	Yes	327536	0.135
821-2LSPC	407	10	10	Yes	318763	0.8944	821-H	407	<b>10</b>	100	No	326522	0.0535
821-2LSPCI	407	10	10	Yes	318732	0.1287	821-H	408	<b>10</b>	100	No	326522	0.0535
821-2LSPN	408	10	10	Yes	319036	0.8934	821-H	409	<b>10</b>	100	No	326522	0.0535
821-2LSQ	411	1	5	Yes	319081	1.0895	821-H	409	<b>10</b>	100	No	326522	0.0535
821-2LSR	411	1	5	Yes	319074	0.87	821-H	410	<b>10</b>	100	No	326522	0.0535
821-2LT4A	413	<b>1</b>	4	Yes	325341	0.45	821-H	411	<b>10</b>	100	No	326522	0.0535
821-2LT5A	413	1	10	Yes	325457	0.615	821-H	411	<b>10</b>	100	No	326522	0.0535
821-2LTQ	413	1	20	Yes	322814	1.1974	821-H	413	<b>10</b>	100	No	326522	0.0535
821-2P	407	20	20	Yes	300355	0.9206	821-H	414	<b>10</b>	100	No	326522	0.0535
821-2PCP	412	1	5	Yes	300379	1.749	821-H	419	<b>10</b>	100	No	326522	0.0535
821-2PPK	407	8	8	Yes	378330	0.8293	821-H	419	<b>10</b>	100	No	326522	0.0535
821-2PQCP	412	1	5	Yes	381194	1.59	821-H	420	<b>10</b>	100	No	326522	0.0535
821-2PQRB	412	1	5	Yes	309631	1.988	821-H	420	<b>10</b>	100	No	326522	0.0535
821-2PT4A	413	<b>1</b>	5	Yes	325327	1.01	821-HA2	407	25	25	Yes	318701	0.9276
821-2PT5A	413	1	5	Yes	325488	1.17	821-HA2	408	25	25	Yes	318701	0.9276
821-2PTQ	413	1	1	Yes	322821	1.8415	821-HCP	412	1	5	Yes	351609	0.9195
821-2QARB	408	5	5	Yes	313140	0.2923	821-HCP	416	1	5	Yes	351609	0.9195
821-2QAS	408	5	5	Yes	313010	0.304	821-HP2	407	25	25	Yes	318695	0.9519
821-2S	422	1	100	Yes	300393	0.2219	821-HP2	408	25	25	Yes	318695	0.9519
821-2SCQPK1	423	1	10	Yes	320865	0.7213	821-HQCP	412	1	5	Yes	308979	0.9195
821-2SCQPK2	423	1	50	Yes	320926	0.9796	821-HQCP	416	1	5	Yes	308979	0.9195
821-2SCRPK1	422	1	10	Yes	320858	0.9935	821-HSQ	416	1	10	Yes	379771	0.0876
821-2SCRPK2	422	1	50	Yes	320933	0.723	821-HSR	416	1	10	Yes	379757	0.1126
821-2SKQPK1	423	1	10	Yes	324634	0.707	821-MHA2	408	25	25	Yes	329547	0.446
821-2SKQPK2	423	1	50	Yes	320841	0.6465	821-MHA2	409	25	25	Yes	329547	0.446
821-2SKRPK1	422	6	6	Yes	324627	0.7167	821-MHA2	410	25	25	Yes	329547	0.446
821-2SKRPK2	422	1	50	Yes	320834	0.4342	821-MHA2	411	25	25	Yes	329547	0.446
821-2SMQPK2	423	1	5	Yes	703569	0.56	821-MHA2	411	25	25	Yes	329547	0.446
821-2SMRPK2	422	1	5	Yes	703576	0.39	821-MHA2	412	25	25	Yes	329547	0.446
821-2SNQPK1	423	1	10	Yes	321053	1.4115	821-MHA2	413	25	25	Yes	329547	0.446
821-2SNRPK1	423	6	6	Yes	315427	0.8831	821-MHP2	408	<b>25</b>	25	Yes	329455	0.468
821-2SPK1	422	10	10	Yes	300904	0.249	821-MHP2	409	<b>25</b>	25	Yes	329455	0.468
821-2SRBQPK1	423	1	10	Yes	320872	1.0154	821-MHP2	410	<b>25</b>	25	Yes	329455	0.468
821-2SRBQPK2	423	1	50	Yes	320940	0.8982	821-MHP2	411	<b>25</b>	25	Yes	329455	0.468
821-2SRBRPK1	422	6	6	Yes	315441	0.8833	821-MHP2	411	<b>25</b>	25	Yes	329455	0.468
821-2SRBRPK2	422	1	50	Yes	320957	0.6692	821-MHP2	412	<b>25</b>	25	Yes	329455	0.468
821-2SSQPK1	423	1	10	Yes	321060	1.144	821-MHP2	413	<b>25</b>	25	Yes	329455	0.468
821-2SSRPK1	423	1	10	Yes	321022	0.8699	821-T200A	407	10	10	Yes	380951	0.7009
821-EX2	407	1	10	Yes	327536	0.135	821-T200ACQ	409	1	5	Yes	312433	1.96
821-EX2	408	1	10	Yes	327536	0.135	821-T200ACR	409	5	5	Yes	312402	-
821-EX2	409	1	10	Yes	327536	0.135	821-T200AKQ	410	1	5	Yes	325631	2.387
821-EX2	409	1	10	Yes	327536	0.135	821-T200AKR	410	1	5	Yes	325648	1.3679

Supply

Drainage

Support

Specialties

Appendix

# Numerical Index

Supply

Drainage

Support

Specialties

Appendix

Item No	Page No	Min Qty	Case Qty	UPC Bar-Coded	UPC 6-Digit	Weight (lbs.)	Item No	Page No	Min Qty	Case Qty	UPC Bar-Coded	UPC 6-Digit	Weight (lbs.)
821-T200ANQ	408	1	5	Yes	380968	2.3821	821-TMHP2	411	25	25	Yes	703231	0.4583
821-T200ANR	408	5	5	Yes	380975	1.8832	821-TMHP2	411	25	25	Yes	703231	0.4583
821-T200ARBQ	411	1	5	Yes	380982	3.2613	821-TMHP2	412	25	25	Yes	703231	0.4583
821-T200ARBR	411	1	5	Yes	380999	1.865	821-TMHP2	413	25	25	Yes	703231	0.4583
821-T200ASQ	410	1	5	Yes	310262	2.005	821-TP	407	10	10	Yes	381187	0.0229
821-T200ASR	410	5	5	Yes	310279	1.748	821-TP	408	10	10	Yes	381187	0.0229
821-T200P	407	10	10	Yes	381002	0.9658	821-TP	409	10	10	Yes	381187	0.0229
821-T200PCQ	409	1	5	Yes	312440	1.7437	821-TP	409	10	10	Yes	381187	0.0229
821-T200PCR	409	5	5	Yes	312457	1.892	821-TP	410	10	10	Yes	381187	0.0229
821-T200PKQ	410	1	5	Yes	325655	1.5952	821-TP	411	10	10	Yes	381187	0.0229
821-T200PKR	410	5	5	Yes	325693	1.4569	821-TP	412	10	10	Yes	381187	0.0229
821-T200PNQ	408	5	5	Yes	381019	2.3635	821-TP	413	10	10	Yes	381187	0.0229
821-T200PNR	408	5	5	Yes	381026	1.8645	821-TP	414	10	10	Yes	381187	0.0229
821-T200PRBQ	411	1	5	Yes	381033	3.2427	821-TP	417	10	10	Yes	381187	0.0229
821-T200PRBR	411	1	5	Yes	381040	1.6747	821-TP	418	10	10	Yes	381187	0.0229
821-T200PSQ	410	1	5	Yes	310286	2.15	822-2AF	338	1	4	Yes	379146	1.7645
821-T200PSR	410	5	5	Yes	310293	1.896	822-2ANQ	337	1	4	Yes	305640	3.7981
821-T270A	407	1	10	Yes	381071	0.7067	822-2ANR	337	1	4	Yes	300621	3.0931
821-T270AQ	407	1	10	Yes	318534	1.168	822-2AS	337	1	4	Yes	301413	2.2373
821-T270P	407	1	10	Yes	381088	0.8893	822-2ASQ	337	1	4	Yes	307439	3.4531
821-T270PQ	407	1	10	Yes	309600	1.168	822-2ASR	337	1	4	Yes	307446	2.675
821-T2A	407	1	10	Yes	381231	0.7067	822-2DF	253	1	1	Yes	381361	7.0875
821-T2ACP	412	1	5	Yes	381132	1.8517	822-2DNQ	253	1	4	Yes	381330	7.9125
821-T2AQCP	412	1	5	Yes	381149	1.98	822-2DNR	253	1	4	Yes	381316	6.9
821-T2AQRB	412	1	5	Yes	309655	1.994	822-2DSQ	253	1	4	Yes	307453	7.5375
821-T2AT4A	413	1	5	Yes	325358	1.04	822-2DSR	253	1	4	Yes	307460	7.1875
821-T2AT5A	413	1	5	Yes	325471	1.2	822-2PF	338	1	4	Yes	379139	2.4138
821-T2ATQ	413	1	1	Yes	322838	1.7862	822-2PNQ	337	1	4	Yes	301796	3.9051
821-T2P	407	1	10	Yes	381156	0.9619	822-2PNR	337	1	4	Yes	304070	3.2001
821-T2P	411	1	10	Yes	381156	0.9619	822-2PS	337	1	4	Yes	304087	2.3443
821-T2PCP	412	1	5	Yes	381163	1.8331	822-2PSQ	337	1	4	Yes	307477	3.675
821-T2PQCP	412	1	5	Yes	381170	2.14	822-2PSR	337	1	4	Yes	307484	2.9601
821-T2PQRB	412	1	5	Yes	309679	2.112	822-3AF	338	1	4	Yes	379153	2.3048
821-T2PT4A	413	1	5	Yes	325365	1.08	822-3ANQ	337	1	4	Yes	304865	3.7961
821-T2PT5A	413	1	5	Yes	325495	1.23	822-3ANR	337	1	4	Yes	304896	3.0911
821-T2PTQ	413	1	1	Yes	322845	1.8751	822-3AS	337	1	4	Yes	304926	2.2353
821-THA2	407	25	25	Yes	318725	0.9309	822-3ASQ	337	1	4	Yes	307491	3.4511
821-THA2	408	25	25	Yes	318725	0.9309	822-3ASR	337	1	1	Yes	307521	2.9
821-THP2	407	25	25	Yes	318718	0.9123	822-3DF	253	1	4	Yes	381378	6.825
821-THP2	408	25	25	Yes	318718	0.9123	822-3DNQ	253	1	4	Yes	381323	7.75
821-TMHA2	408	25	25	Yes	703224	0.4187	822-3DNR	253	1	4	Yes	381347	7.0375
821-TMHA2	409	25	25	Yes	703224	0.4187	822-3DSQ	253	1	1	Yes	307538	7.4179
821-TMHA2	410	25	25	Yes	703224	0.4187	822-3DSR	253	1	1	Yes	307545	6.95
821-TMHA2	411	25	25	Yes	703224	0.4187	822-3PF	338	1	4	Yes	379160	2.4191
821-TMHA2	411	25	25	Yes	703224	0.4187	822-3PNQ	337	1	4	Yes	304957	3.9001
821-TMHA2	412	25	25	Yes	703224	0.4187	822-3PNR	337	1	4	Yes	305152	2.9916
821-TMHA2	413	25	25	Yes	703224	0.4187	822-3PS	337	1	4	Yes	305442	2.3393
821-TMHP2	408	25	25	Yes	703231	0.4583	822-3PSQ	337	1	4	Yes	307552	3.675
821-TMHP2	409	25	25	Yes	703231	0.4583	822-3PSR	337	1	4	Yes	307569	3.0375
821-TMHP2	410	25	25	Yes	703231	0.4583	822-C3AF	362	1	1	Yes	315403	-



Item No	Page No	Min Qty	Case Qty	UPC Bar-Coded	UPC 6-Digit	Weight (lbs.)	Item No	Page No	Min Qty	Case Qty	UPC Bar-Coded	UPC 6-Digit	Weight (lbs.)
822-C3ANQ	362	1	1	Yes	315182	-	822-F2DNR	254	1	1	Yes	381385	10.15
822-C3ANR	362	1	1	Yes	379993	4.6262	822-F2DSQ	254	1	1	Yes	307590	10.6256
822-C3ASQ	362	1	1	Yes	315199	-	822-F2DSR	254	1	1	Yes	307620	10.0256
822-C3ASR	362	1	1	Yes	315205	-	822-F2PNQ	338	1	1	Yes	380265	4.1769
822-C3DF	298	1	1	Yes	315663	-	822-F2PNR	338	1	1	Yes	380241	3.5789
822-C3DNQ	298	1	1	Yes	315335	-	822-F2PSQ	338	1	1	Yes	307637	4.85
822-C3DNR	298	1	4	Yes	315298	7.37	822-F2PSR	338	1	1	Yes	307644	2.5365
822-C3DSQ	298	1	1	Yes	315373	-	822-F3ANQ	338	1	1	Yes	380333	4.1749
822-C3DSR	298	1	1	Yes	315342	-	822-F3ANR	338	1	1	Yes	380319	4.2301
822-C3PF	362	1	1	Yes	315458	-	822-F3ASQ	338	1	1	Yes	307651	4.4049
822-C3PNQ	362	1	1	Yes	312082	-	822-F3ASR	338	1	1	Yes	307668	3.9901
822-C3PNR	362	1	4	Yes	379931	3.7188	822-F3DNQ	254	1	1	Yes	381415	10.8
822-C3PSQ	362	1	1	Yes	315212	-	822-F3DNR	254	1	1	Yes	381408	10.2
822-C3PSR	362	1	4	Yes	315229	3.6577	822-F3DSQ	254	1	1	Yes	307675	10.3816
822-C4ANQ	362	1	1	Yes	315236	4.686	822-F3DSR	254	1	1	Yes	307682	10.04
822-C4ANR	362	1	1	Yes	377487	3.25	822-F3PNQ	338	1	1	Yes	380326	4.2789
822-C4ASQ	362	1	1	Yes	315243	4.686	822-F3PNR	338	1	1	Yes	380302	4.3341
822-C4ASR	362	1	1	Yes	315250	3.646	822-F3PSQ	338	1	1	Yes	307699	4.6941
822-C4PNQ	362	1	1	Yes	315267	4.79	822-F3PSR	338	1	1	Yes	307705	4.0941
822-C4PNR	362	1	1	Yes	379344	4.1	822-S2A	415	6	6	Yes	733894	-
822-C4PSQ	362	1	1	Yes	315274	4.46	822-S2P	415	6	6	Yes	733900	-
822-C4PSR	362	1	4	Yes	315281	3.7	822-TB	337	1	10	Yes	379573	0.14
822-CF3ANQ	363	1	1	Yes	315519	-	823-24PSS	418	1	1	Yes	314796	8.805
822-CF3ANR	363	1	1	Yes	315526	-	823-24PST	418	1	1	Yes	326089	8.805
822-CF3ASQ	363	1	1	Yes	315533	-	823-32PSS	418	1	1	Yes	314819	11.685
822-CF3ASR	363	1	1	Yes	315540	-	823-32PST	418	1	1	Yes	326096	11.7
822-CF3DNQ	298	1	1	Yes	315717	-	823-40PSS	418	1	1	Yes	314833	14.1
822-CF3DNR	298	1	1	Yes	314505	11.2417	823-40PST	418	1	1	Yes	326102	14.495
822-CF3DSQ	298	1	1	Yes	314857	11.191	823-60PSS	418	1	1	Yes	314529	19.25
822-CF3DSR	298	1	1	Yes	313546	10.5866	823-60PST	418	1	1	Yes	326119	19.55
822-CF3PNQ	363	1	1	Yes	315557	-	823-FK24	418	1	1	Yes	202161	1.65
822-CF3PNR	363	1	1	Yes	313485	5.1335	823-FK32	418	1	1	Yes	202222	2.1
822-CF3PSQ	363	1	1	Yes	315564	-	823-FK40	418	1	1	Yes	202253	2.4
822-CF3PSR	363	1	1	Yes	315571	4.7835	823-FK60	418	1	1	Yes	202260	3.35
822-CKIT	337	1	10	Yes	316585	0.644	823-FKT24	418	1	1	Yes	326898	-
822-CKIT	339	1	10	Yes	316585	0.644	823-FKT32	418	1	1	Yes	326904	-
822-EX3	319	1	1	No	309792	2.0564	823-FKT40	418	1	1	Yes	326911	-
822-EX3	334	1	1	No	309792	2.0564	823-FKT60	418	1	1	Yes	326928	3.4392
822-EX3	337	1	1	No	309792	2.0564	823-T2A36T	418	1	1	Yes	330130	-
822-EX3	339	1	1	No	309792	2.0564	823-T2A36V	418	1	1	Yes	330260	5.1
822-EX3	362	1	1	No	309792	2.0564	823-T2A72T	418	1	1	Yes	330208	-
822-EX3	363	1	1	No	309792	2.0564	823-T2A72V	418	1	1	Yes	330215	-
822-EX3	415	1	1	No	309792	2.0564	823-T2P36T	418	1	1	Yes	330161	-
822-EX3CQ	253	1	1	Yes	726797	-	823-T2P36V	418	1	1	Yes	330321	4.95
822-EX3CQ	254	1	1	Yes	726797	-	823-T2P72T	418	1	1	Yes	330178	12.05
822-F2ANQ	338	1	1	Yes	380272	4.1769	823-T2P72V	418	1	1	Yes	330246	8.75
822-F2ANR	338	1	1	Yes	380258	4.2321	823-TX26SA	417	1	1	Yes	324979	6.316
822-F2ASQ	338	1	1	Yes	307576	-	823-TX26SP	417	1	1	Yes	323736	5.3
822-F2ASR	338	1	1	Yes	307583	3.9921	823-TX26TA	417	1	1	Yes	323767	6.5072
822-F2DNQ	254	1	1	Yes	381392	11.15	823-TX26TP	417	1	1	Yes	323583	6.5962

Supply

Drainage

Support

Specialties

Appendix

# Numerical Index

Supply

Drainage

Support

Specialties

Appendix

Item No	Page No	Min Qty	Case Qty	UPC Bar-Coded	UPC 6-Digit	Weight (lbs.)	Item No	Page No	Min Qty	Case Qty	UPC Bar-Coded	UPC 6-Digit	Weight (lbs.)
823-TX26WA	417	<b>1</b>	1	Yes	323705	7.8072	827-2J	420	1	6	Yes	302045	2.2107
823-TX26WP	417	<b>1</b>	1	Yes	323521	7.2	827-2RB	422	1	100	Yes	374387	0.1554
823-TX30SA	417	<b>1</b>	1	Yes	323835	6.916	827-2RBPK1	422	6	6	Yes	315366	0.2183
823-TX30SP	417	<b>1</b>	1	Yes	323651	5.8	827-2RBQ	422	1	100	Yes	331144	0.2145
823-TX30TA	417	<b>1</b>	1	Yes	323774	7.1072	827-2RBQPK1	422	1	5	Yes	722959	0.27
823-TX30TP	417	<b>1</b>	1	Yes	323590	7.1962	827-2S	422	1	100	Yes	300645	0.1482
823-TX30WA	417	<b>1</b>	1	Yes	323712	9.3072	827-2SMQPK1	422	1	5	Yes	703583	0.27
823-TX30WP	417	<b>1</b>	1	Yes	323538	8.2	827-2SMRPK1	422	1	5	Yes	703590	0.22
823-TX36SA	417	<b>1</b>	1	Yes	323842	7.5072	827-2SNPK2	422	1	5	Yes	320988	0.21
823-TX36SP	417	<b>1</b>	1	Yes	323668	6.7	827-2SNQPK1	422	1	5	Yes	722973	0.4
823-TX36TA	417	<b>1</b>	1	Yes	324986	8.1072	827-2SPK1	422	10	10	Yes	301741	0.204
823-TX36TP	417	<b>1</b>	1	Yes	329370	7.5	827-2SPPK1	422	5	5	Yes	301758	0.28
823-TX36WA	417	<b>1</b>	1	Yes	323729	10.7072	827-2SQPK1	422	1	5	Yes	722980	-
823-TX36WP	417	<b>1</b>	1	Yes	323545	9.2	827-2SWPK1	422	5	5	Yes	315410	0.2751
823-TX40SA	417	<b>1</b>	1	Yes	323859	7.9072	828-2	419	1	20	Yes	300676	0.6066
823-TX40SP	417	<b>1</b>	1	Yes	323675	7.9962	828-2PK	419	10	10	Yes	301710	0.5466
823-TX40TA	417	<b>1</b>	1	Yes	324900	8.7072	828-GC	419	1	1	No	328298	0.13
823-TX40TP	417	<b>1</b>	1	Yes	329387	7.85	828-GC	420	1	1	No	328298	0.13
823-TX40WA	417	<b>1</b>	1	Yes	325167	11.5072	832-25AF	318	1	10	Yes	305459	1.2149
823-TX40WP	417	<b>1</b>	1	Yes	323552	11.43	832-25ANQ	319	1	1	Yes	305466	4.0067
823-TX48SA	417	<b>1</b>	1	Yes	323866	8.5139	832-25ANR	319	1	1	Yes	305473	3.2705
823-TX48SP	417	<b>1</b>	1	Yes	323682	8.5535	832-25ASQ	319	1	1	Yes	307712	3.6617
823-TX48TA	417	<b>1</b>	1	Yes	323804	9.9072	832-25ASR	319	1	1	Yes	307729	3
823-TX48TP	417	<b>1</b>	1	Yes	323620	9.9962	832-25DF	238	1	1	Yes	381446	5.995
823-TX48WA	417	<b>1</b>	1	Yes	323743	13.5072	832-25DNQ	238	1	1	Yes	381484	9.95
823-TX48WP	417	<b>1</b>	1	Yes	323569	12.5	832-25DNR	238	1	1	Yes	381460	9.15
823-TX60SA	417	<b>1</b>	1	Yes	323873	11.1072	832-25DSQ	238	1	1	Yes	307736	9.6662
823-TX60SP	417	<b>1</b>	1	Yes	323699	10.15	832-25DSR	238	1	1	Yes	307743	8.9
823-TX60TA	417	<b>1</b>	1	Yes	323811	12.2139	832-25PF	318	1	10	Yes	306173	1.37
823-TX60TP	417	<b>1</b>	1	Yes	329394	12.65	832-25PNQ	319	1	1	Yes	306180	3.5073
823-TX60WA	417	<b>1</b>	1	Yes	323750	16.516	832-25PNR	319	1	1	Yes	306197	2.7711
823-TX60WP	417	<b>1</b>	1	Yes	323576	14.35	832-25PSQ	319	1	1	Yes	307750	3.1623
825-17P	419	20	20	Yes	356277	0.6939	832-25PSR	319	1	1	Yes	307767	3.15
825-1P	419	20	20	Yes	356291	0.6988	832-2AF	317	1	10	Yes	377425	1.7364
825-20A	419	20	20	Yes	300423	0.4143	832-2ANQ	317	1	1	Yes	377418	5.091
825-20P	419	20	20	Yes	300430	0.5875	832-2ANR	317	1	1	Yes	377395	3.937
825-27A	419	20	20	Yes	300447	0.5172	832-2ASQ	317	1	1	Yes	307774	4.9099
825-27P	419	20	20	Yes	300454	0.5775	832-2ASR	317	1	1	Yes	307781	3.7
825-2A	419	<b>20</b>	20	Yes	300478	0.5215	832-2PF	317	1	10	Yes	376565	2.0409
825-2AFS	419	10	10	Yes	301574	0.2029	832-2PNQ	317	1	1	Yes	377401	5.3261
825-2APK	419	12	12	Yes	301543	0.6051	832-2PNR	317	1	1	Yes	376510	4.4345
825-2P	419	<b>20</b>	20	Yes	300492	0.5833	832-2PSQ	317	1	1	Yes	307798	4.9
825-2PFS	419	10	10	Yes	301550	0.828	832-2PSR	317	1	1	Yes	307804	4
825-2PPK	419	12	12	Yes	301505	0.5913	832-35AF	318	1	10	Yes	306210	1.2129
826-2A	420	1	20	Yes	301826	0.5193	832-35ANQ	319	1	1	Yes	306227	4.0047
826-2P	420	1	20	Yes	352231	0.5888	832-35ANR	319	1	1	Yes	306234	3.2685
826-2PPK	420	10	10	Yes	301802	0.6226	832-35ASQ	319	1	1	Yes	307811	3.6597
827-2B	419	10	20	Yes	301765	1.3075	832-35ASR	319	1	1	Yes	307828	3.0285
827-2BG	419	1	100	No	300577	0.0758	832-35DF	238	1	1	Yes	381453	6.3735
827-2BG	420	1	100	No	300577	0.0758	832-35DNQ	238	1	1	Yes	381491	9.4

Item No	Page No	Min Qty	Case Qty	UPC Bar-Coded	UPC 6-Digit	Weight (lbs.)	Item No	Page No	Min Qty	Case Qty	UPC Bar-Coded	UPC 6-Digit	Weight (lbs.)
832-35DNR	238	1	1	Yes	381477	9.4	832-3HNR	318	1	10	Yes	306296	1.5212
832-35DSQ	238	1	1	Yes	307835	9.75	832-3HNR	326	1	10	Yes	306296	1.5212
832-35DSR	238	1	1	Yes	307842	8.65	832-3HNR	329	1	10	Yes	306296	1.5212
832-35PF	318	1	10	Yes	306241	1.3413	832-3HNR	332	1	10	Yes	306296	1.5212
832-35PNQ	319	1	1	Yes	306258	4.1087	832-3HNR	338	1	10	Yes	306296	1.5212
832-35PNR	319	1	1	Yes	306272	3.3725	832-3HS	319	1	20	No	708366	0.72
832-35PSQ	319	1	1	Yes	307859	3.6	832-3HS	327	1	20	No	708366	0.72
832-35PSR	319	1	1	Yes	307866	3	832-3HS	330	1	20	No	708366	0.72
832-36AF	317	1	10	Yes	374677	1.413	832-3HS	332	1	20	No	708366	0.72
832-36ANQ	317	1	1	Yes	374806	4.8811	832-3HS	339	1	20	No	708366	0.72
832-36ANR	317	1	1	Yes	374721	3.8814	832-3HSQ	318	1	10	Yes	381644	2.076
832-36ASQ	317	1	1	Yes	381583	4.6099	832-3HSQ	326	1	10	Yes	381644	2.076
832-36ASR	317	1	1	Yes	381590	3.38	832-3HSQ	329	1	10	Yes	381644	2.076
832-36PF	317	1	10	Yes	374226	1.5898	832-3HSQ	332	1	10	Yes	381644	2.076
832-36PNQ	317	1	1	Yes	374530	5.0345	832-3HSQ	338	1	10	Yes	381644	2.076
832-36PNR	317	1	1	Yes	374462	3.5	832-3HSR	318	1	10	Yes	381651	1.53
832-36PSQ	317	1	1	Yes	381606	4.8	832-3HSR	326	1	10	Yes	381651	1.53
832-36PSR	317	1	1	Yes	381613	3.65	832-3HSR	329	1	10	Yes	381651	1.53
832-3DF	237	1	5	Yes	376046	6.6064	832-3HSR	332	1	10	Yes	381651	1.53
832-3DHNQ	238	1	1	Yes	381514	3.6	832-3HSR	338	1	10	Yes	381651	1.53
832-3DHNQ	243	1	1	Yes	381514	3.6	832-3SF	241	1	1	Yes	381668	-
832-3DHNQ	246	1	1	Yes	381514	3.6	832-3SSQ	241	1	1	Yes	381675	-
832-3DHNQ	253	1	1	Yes	381514	3.6	832-3SSR	241	1	1	Yes	381682	9.85
832-3DHNR	238	1	10	Yes	381507	2.85	832-49DF	239	1	1	Yes	310026	8.2494
832-3DHNR	243	1	10	Yes	381507	2.85	832-49DNR	239	1	1	Yes	310033	14.5234
832-3DHNR	246	1	10	Yes	381507	2.85	832-49DSR	239	1	1	Yes	310040	14.9253
832-3DHNR	253	1	10	Yes	381507	2.85	832-4AF	317	1	10	Yes	374660	1.6212
832-3DHSQ	238	1	1	Yes	381620	3.1918	832-4ANQ	317	1	1	Yes	374820	5.0148
832-3DHSQ	243	1	1	Yes	381620	3.1918	832-4ANR	317	1	1	Yes	374745	4.0148
832-3DHSQ	246	1	1	Yes	381620	3.1918	832-4ASQ	317	1	1	Yes	381699	4.7436
832-3DHSQ	253	1	1	Yes	381620	3.1918	832-4ASR	317	1	1	Yes	381705	3.55
832-3DHSR	238	1	1	Yes	381637	2.7	832-4ADF	237	1	5	Yes	376084	6.7017
832-3DHSR	243	1	1	Yes	381637	2.7	832-4DHIR	237	1	10	Yes	376091	3.3488
832-3DHSR	246	1	1	Yes	381637	2.7	832-4DHIR	240	1	10	Yes	376091	3.3488
832-3DHSR	253	1	1	Yes	381637	2.7	832-4DHIR	242	1	10	Yes	376091	3.3488
832-3DIR	237	1	1	Yes	376053	10.325	832-4DHIR	244	1	10	Yes	376091	3.3488
832-3DNQ	237	1	1	Yes	376060	11.0378	832-4DHNQ	237	1	10	Yes	376107	4.2546
832-3DNR	237	1	1	Yes	376077	10.1486	832-4DHNQ	240	1	10	Yes	376107	4.2546
832-3DSQ	237	1	1	Yes	381781	11.0786	832-4DHNQ	242	1	10	Yes	376107	4.2546
832-3DSR	237	1	1	Yes	381798	9.9	832-4DHNQ	244	1	10	Yes	376107	4.2546
832-3HHD	319	1	10	Yes	315793	0.849	832-4DHNR	237	1	10	Yes	376114	3.3738
832-3HHD	327	1	10	Yes	315793	0.849	832-4DHNR	240	1	10	Yes	376114	3.3738
832-3HHD	330	1	10	Yes	315793	0.849	832-4DHNR	242	1	10	Yes	376114	3.3738
832-3HHD	332	1	10	Yes	315793	0.849	832-4DHNR	244	1	10	Yes	376114	3.3738
832-3HHD	339	1	10	Yes	315793	0.849	832-4DHSQ	237	1	10	Yes	381712	4.208
832-3HNQ	318	1	10	Yes	306289	2.2	832-4DHSQ	240	1	10	Yes	381712	4.208
832-3HNQ	326	1	10	Yes	306289	2.2	832-4DHSQ	242	1	10	Yes	381712	4.208
832-3HNQ	329	1	10	Yes	306289	2.2	832-4DHSQ	244	1	10	Yes	381712	4.208
832-3HNQ	332	1	10	Yes	306289	2.2	832-4DHSR	237	1	10	Yes	381729	3.025
832-3HNQ	338	1	10	Yes	306289	2.2	832-4DHSR	240	1	10	Yes	381729	3.025

Supply

Drainage

Support

Specialties

Appendix

# Numerical Index

Supply

Drainage

Support

Specialties

Appendix

Item No	Page No	Min Qty	Case Qty	UPC Bar-Coded	UPC 6-Digit	Weight (lbs.)	Item No	Page No	Min Qty	Case Qty	UPC Bar-Coded	UPC 6-Digit	Weight (lbs.)
832-4DSR	242	1	10	Yes	381729	3.025	832-64DNR	240	1	1	Yes	306432	12.0941
832-4DSR	244	1	10	Yes	381729	3.025	832-64DSQ	240	1	1	Yes	381880	13.058
832-4DIR	237	1	1	Yes	376121	10.2662	832-64DSR	240	1	1	Yes	381897	11.93
832-4DNQ	237	1	1	Yes	376138	11.0158	832-6DF	239	1	1	Yes	310057	15.05
832-4DNR	237	1	1	Yes	376145	9.9208	832-6DHR	239	1	1	Yes	310064	5.55
832-4DSQ	237	1	1	Yes	381804	10.9886	832-6DHSR	239	1	1	Yes	310071	5.7615
832-4DSR	237	1	1	Yes	381811	9.85	832-6DNR	239	1	1	Yes	310088	20.45
832-4HHD	318	1	10	Yes	377609	0.9304	832-6DSR	239	1	1	Yes	310095	16.4397
832-4HHD	326	1	10	Yes	377609	0.9304	832-EP3	319	1	1	Yes	713728	0.9504
832-4HHD	329	1	10	Yes	377609	0.9304	832-EP3	327	1	1	Yes	713728	0.9504
832-4HHD	331	1	10	Yes	377609	0.9304	832-EP3	339	1	1	Yes	713728	0.9504
832-4HNQ	317	1	10	Yes	374080	2.7186	832-EX3	319	1	1	Yes	318565	0.2164
832-4HNQ	325	1	10	Yes	374080	2.7186	832-EX3	327	1	1	Yes	318565	0.2164
832-4HNQ	328	1	10	Yes	374080	2.7186	832-EX3	330	1	1	Yes	318565	0.2164
832-4HNQ	330	1	10	Yes	374080	2.7186	832-EX3	332	1	1	Yes	318565	0.2164
832-4HNR	317	1	10	Yes	373908	1.5555	832-EX3	339	1	1	Yes	318565	0.2164
832-4HNR	325	1	10	Yes	373908	1.5555	832-EX3	363	1	1	Yes	318565	0.2164
832-4HNR	328	1	10	Yes	373908	1.5555	832-EX3CQ	238	1	1	Yes	726438	-
832-4HNR	330	1	10	Yes	373908	1.5555	832-EX3CQ	244	1	1	Yes	726438	-
832-4HPR	318	1	10	Yes	711960	0.945	832-EX3CQ	246	1	1	Yes	726438	-
832-4HPR	326	1	10	Yes	711960	0.945	832-EX3CQ	254	1	1	Yes	726438	-
832-4HPR	329	1	10	Yes	711960	0.945	832-EX4	318	1	1	Yes	374943	1.545
832-4HPR	331	1	10	Yes	711960	0.945	832-EX4	326	1	1	Yes	374943	1.545
832-4HSQ	317	1	1	Yes	381736	2.95	832-EX4	329	1	1	Yes	374943	1.545
832-4HSQ	325	1	1	Yes	381736	2.95	832-EX4	331	1	1	Yes	374943	1.545
832-4HSQ	328	1	1	Yes	381736	2.95	832-EX4	359	1	1	Yes	374943	1.545
832-4HSQ	330	1	1	Yes	381736	2.95	832-EX4CQ	237	1	1	Yes	726445	1.4
832-4HSR	317	1	10	Yes	381743	1.714	832-EX4CQ	240	1	1	Yes	726445	1.4
832-4HSR	325	1	10	Yes	381743	1.714	832-EX4CQ	243	1	1	Yes	726445	1.4
832-4HSR	328	1	10	Yes	381743	1.714	832-EX4CQ	245	1	1	Yes	726445	1.4
832-4HSR	330	1	10	Yes	381743	1.714	832-EX4CQ	287	1	1	Yes	726445	1.4
832-4PF	317	1	10	Yes	374363	1.7776	832-EX4CQ	289	1	1	Yes	726445	1.4
832-4PNQ	317	1	1	Yes	374547	5.1712	832-P	318	1	1	Yes	327871	1.05
832-4PNR	317	1	1	Yes	374400	4.1712	832-P	319	1	1	Yes	327871	1.05
832-4PSQ	317	1	1	Yes	381750	4.9	832-P	326	1	1	Yes	327871	1.05
832-4PSR	318	1	1	Yes	381767	3.75	832-P	327	1	1	Yes	327871	1.05
832-4SF	241	1	1	Yes	381774	-	832-P	329	1	1	Yes	327871	1.05
832-4SHSQ	241	1	1	Yes	381828	4.117	832-P	330	1	1	Yes	327871	1.05
832-4SHSR	241	1	1	Yes	381835	3.878	832-P	331	1	1	Yes	327871	1.05
832-4SSQ	241	1	1	Yes	381842	-	832-P	332	1	1	Yes	327871	1.05
832-4SSR	241	1	1	Yes	381859	9.95	832-P	339	1	1	Yes	327871	1.05
832-63DF	239	1	1	Yes	306319	7.2966	832-PCQ	237	1	1	Yes	726452	-
832-63DIR	240	1	1	Yes	306333	10.5602	832-PCQ	238	1	1	Yes	726452	-
832-63DNQ	240	1	1	Yes	306340	11.5096	832-PCQ	239	1	1	Yes	726452	-
832-63DNR	240	1	1	Yes	306357	10.3648	832-PCQ	240	1	1	Yes	726452	-
832-63DSQ	240	1	1	Yes	381866	11.3286	832-PCQ	241	1	1	Yes	726452	-
832-63DSR	240	1	1	Yes	381873	11.0896	832-PCQ	243	1	1	Yes	726452	-
832-64DF	239	1	1	Yes	306371	9.0259	832-PCQ	244	1	1	Yes	726452	-
832-64DIR	240	1	1	Yes	306395	12.262	832-PCQ	245	1	1	Yes	726452	-
832-64DNQ	240	1	1	Yes	306418	13.239	832-PCQ	246	1	1	Yes	726452	-

Item No	Page No	Min Qty	Case Qty	UPC Bar-Coded	UPC 6-Digit	Weight (lbs.)	Item No	Page No	Min Qty	Case Qty	UPC Bar-Coded	UPC 6-Digit	Weight (lbs.)
832-PCQ	287	1	1	Yes	726452	-	832-WCQ	238	1	1	Yes	726513	-
832-PCQ	288	1	1	Yes	726452	-	832-WCQ	239	1	1	Yes	726513	-
832-PCQ	289	1	1	Yes	726452	-	832-WCQ	240	1	1	Yes	726513	-
832-PCQ	290	1	1	Yes	726452	-	832-WCQ	241	1	1	Yes	726513	-
832-S3	319	1	10	Yes	374318	0.0868	832-WCQ	243	1	1	Yes	726513	-
832-S3	327	1	10	Yes	374318	0.0868	832-WCQ	244	1	1	Yes	726513	-
832-S3	330	1	10	Yes	374318	0.0868	832-WCQ	245	1	1	Yes	726513	-
832-S3	332	1	10	Yes	374318	0.0868	832-WCQ	246	1	1	Yes	726513	-
832-S3	339	1	10	Yes	374318	0.0868	832-WCQ	287	1	1	Yes	726513	-
832-S3	363	1	10	Yes	374318	0.0868	832-WCQ	288	1	1	Yes	726513	-
832-S3CQ	238	1	1	Yes	726469	-	832-WCQ	289	1	1	Yes	726513	-
832-S3CQ	244	1	1	Yes	726469	-	832-WCQ	290	1	1	Yes	726513	-
832-S3CQ	246	1	1	Yes	726469	-	833-225DF	243	1	1	Yes	381903	12.55
832-S3CQ	254	1	1	Yes	726469	-	833-225DNQ	243	1	1	Yes	381910	16.2751
832-S4	318	1	10	Yes	373823	0.098	833-225DNR	243	1	1	Yes	381927	15.4
832-S4	326	1	10	Yes	373823	0.098	833-225DSQ	243	1	1	Yes	381934	15.9301
832-S4	329	1	10	Yes	373823	0.098	833-225DSR	243	1	1	Yes	381941	15.04
832-S4	331	1	10	Yes	373823	0.098	833-225F	329	1	1	Yes	381958	8.53
832-S4	359	1	10	Yes	373823	0.098	833-225NQ	329	1	1	Yes	381965	11.042
832-S4CQ	237	1	1	Yes	726476	-	833-225NR	329	1	1	Yes	381972	10.337
832-S4CQ	240	1	1	Yes	726476	-	833-225SQ	329	1	1	Yes	381989	10.6974
832-S4CQ	241	1	1	Yes	726476	-	833-225SR	329	1	1	Yes	381996	10.0974
832-S4CQ	243	1	1	Yes	726476	-	833-22DF	242	1	1	Yes	376152	12.738
832-S4CQ	245	1	1	Yes	726476	-	833-22DIR	242	1	1	Yes	376169	15.7778
832-S4CQ	287	1	1	Yes	726476	-	833-22DNQ	242	1	1	Yes	376176	16.9359
832-S4CQ	289	1	1	Yes	726476	-	833-22DNR	242	1	1	Yes	376183	15.7631
832-S4CQ	290	1	1	Yes	726476	-	833-22DSQ	242	1	1	Yes	382009	16.77
832-SD9	239	1	1	Yes	727602	8.35	833-22DSR	242	1	1	Yes	382016	16.531
832-UM	318	1	15	Yes	356505	0.1599	833-22F	328	1	1	Yes	374851	8.2898
832-UM	322	1	15	Yes	356505	0.1599	833-22NQ	328	1	1	Yes	374868	11.8594
832-UM	326	1	15	Yes	356505	0.1599	833-22NR	328	1	1	Yes	374875	10.8594
832-UM	329	1	15	Yes	356505	0.1599	833-22SQ	328	1	1	Yes	382023	11.5946
832-UM	331	1	15	Yes	356505	0.1599	833-22SR	328	1	1	Yes	382030	10.5752
832-UMCQ	237	1	1	Yes	726506	0.85	833-235DF	243	1	1	Yes	382047	11.9
832-UMCQ	240	1	1	Yes	726506	0.85	833-235DNQ	243	1	1	Yes	382054	14.5241
832-UMCQ	241	1	1	Yes	726506	0.85	833-235DNR	243	1	1	Yes	382061	14.3
832-UMCQ	243	1	1	Yes	726506	0.85	833-235DSQ	243	1	1	Yes	382078	14.1791
832-UMCQ	245	1	1	Yes	726506	0.85	833-235DSR	243	1	1	Yes	382085	14.71
832-W	318	1	10	Yes	303349	0.0896	833-235F	329	1	1	Yes	382092	6.9946
832-W	319	1	10	Yes	303349	0.0896	833-235NQ	329	1	1	Yes	382108	9.291
832-W	326	1	10	Yes	303349	0.0896	833-235NR	329	1	1	Yes	382115	8.586
832-W	327	1	10	Yes	303349	0.0896	833-235SQ	329	1	1	Yes	382122	8.9464
832-W	329	1	10	Yes	303349	0.0896	833-235SR	329	1	1	Yes	382139	9.13
832-W	330	1	10	Yes	303349	0.0896	833-23DF	242	1	1	Yes	376190	10.987
832-W	331	1	10	Yes	303349	0.0896	833-23DIR	242	1	1	Yes	376206	15.2927
832-W	332	1	10	Yes	303349	0.0896	833-23DNQ	242	1	1	Yes	376213	14.7
832-W	339	1	10	Yes	303349	0.0896	833-23DNR	242	1	1	Yes	376220	15.0649
832-W	359	1	10	Yes	303349	0.0896	833-23DSQ	242	1	1	Yes	382146	15.019
832-W	363	1	10	Yes	303349	0.0896	833-23DSR	242	1	1	Yes	382153	14.85
832-WCQ	237	1	1	Yes	726513	-	833-23F	328	1	1	Yes	374905	7.1238

Supply

Drainage

Support

Specialties

Appendix

# Numerical Index

Supply

Drainage

Support

Specialties

Appendix

Item No	Page No	Min Qty	Case Qty	UPC Bar-Coded	UPC 6-Digit	Weight (lbs.)	Item No	Page No	Min Qty	Case Qty	UPC Bar-Coded	UPC 6-Digit	Weight (lbs.)
833-23NQ	328	1	1	Yes	374912	10.1084	833-3PF	325	1	10	Yes	373878	2.5721
833-23NR	328	1	1	Yes	374929	9.1084	833-3PNQ	325	1	1	Yes	375070	5.5997
833-23SQ	328	1	1	Yes	382160	9.8436	833-3PNR	325	1	1	Yes	374233	4.3586
833-23SR	328	1	1	Yes	382177	9.57	833-3PSQ	325	1	1	Yes	382481	5.7938
833-24DF	242	1	1	Yes	376237	11.9711	833-3PSR	325	1	1	Yes	382498	4.5
833-24DIR	242	1	1	Yes	376244	15.3883	833-4AF	325	1	10	Yes	375162	5.0604
833-24DNQ	242	1	1	Yes	376251	16.6523	833-4ANQ	325	1	1	Yes	375179	7.2236
833-24DNR	242	1	1	Yes	376268	14.8151	833-4ANR	325	1	1	Yes	375186	6.2236
833-24DSQ	242	1	1	Yes	382184	16.519	833-4ASQ	325	1	1	Yes	382504	5.6588
833-24DSR	242	1	1	Yes	382191	16.28	833-4ASR	325	1	1	Yes	382511	4.633
833-24F	328	1	1	Yes	373885	8.0388	833-4PF	325	1	10	Yes	374356	3.779
833-24NQ	328	1	1	Yes	374950	11.6084	833-4PNQ	325	1	1	Yes	375483	7.3486
833-24NR	328	1	1	Yes	374974	10.6084	833-4PNR	325	1	1	Yes	374240	6.3486
833-24SQ	328	1	1	Yes	382207	11.3436	833-4PSQ	325	1	1	Yes	382528	5.7941
833-24SR	328	1	1	Yes	382214	10.3242	833-4PSR	325	1	1	Yes	382535	4.45
833-25AF	326	1	1	Yes	382221	2.206	833-625DF	246	1	1	Yes	382542	11.2566
833-25ANQ	327	1	1	Yes	382238	4.892	833-625DNQ	246	1	1	Yes	382559	14.7941
833-25ANR	327	1	1	Yes	382245	4.187	833-625DNR	246	1	1	Yes	382566	14.0891
833-25ASQ	327	1	1	Yes	382252	4.5466	833-625DSQ	246	1	1	Yes	382573	14.4491
833-25ASR	327	1	1	Yes	382269	3.82	833-625DSR	246	1	1	Yes	382580	13.8491
833-25PF	326	1	1	Yes	382276	2.491	833-625F	332	1	1	Yes	382597	7.2646
833-25PNQ	327	1	1	Yes	382283	5.177	833-625NQ	332	1	1	Yes	382603	9.561
833-25PNR	327	1	1	Yes	382290	4.472	833-625NR	332	1	1	Yes	382610	8.856
833-25PSQ	327	1	1	Yes	382306	4.8316	833-625SQ	332	1	1	Yes	382627	9.2164
833-25PSR	327	1	1	Yes	382313	4.2316	833-625SR	332	1	1	Yes	382634	8.6164
833-2AF	325	1	10	Yes	375001	2.3317	833-62DF	244	1	1	Yes	376275	10.692
833-2ANQ	325	1	1	Yes	375018	7.0086	833-62DIR	245	1	1	Yes	376282	14.522
833-2ANR	325	1	1	Yes	375025	4.727	833-62DNQ	245	1	1	Yes	376299	14.522
833-2ASQ	325	1	1	Yes	382320	5.4541	833-62DNR	245	1	1	Yes	376305	14.31
833-2ASR	325	1	1	Yes	382337	4.21	833-62DSQ	245	1	1	Yes	382641	15.289
833-2PF	325	1	10	Yes	374325	2.6168	833-62DSR	245	1	1	Yes	382658	15.05
833-2PNQ	325	1	1	Yes	375056	5.585	833-62F	330	1	1	Yes	375230	6.8088
833-2PNR	325	1	1	Yes	365194	4.65	833-62NQ	331	1	1	Yes	375247	10.3784
833-2PSQ	325	1	1	Yes	382344	5.7392	833-62NR	331	1	1	Yes	375261	10.9505
833-2PSR	325	1	1	Yes	382351	4.7198	833-62SQ	331	1	1	Yes	382665	10.1136
833-35AF	326	1	1	Yes	382368	2.371	833-62SR	331	1	1	Yes	382672	9.0878
833-35ANQ	327	1	1	Yes	382375	5.057	833-635DF	246	1	1	Yes	382689	12.8266
833-35ANR	327	1	1	Yes	382382	4.352	833-635DNQ	246	1	1	Yes	304186	16.3641
833-35ASQ	327	1	1	Yes	382399	4.7116	833-635DNR	246	1	1	Yes	304414	15.315
833-35ASR	327	1	1	Yes	382405	3.9	833-635DSQ	246	1	1	Yes	304438	16.0191
833-35PF	326	1	1	Yes	382412	2.556	833-635DSR	246	1	1	Yes	305206	14.95
833-35PNQ	327	1	1	Yes	382429	5.242	833-635F	332	1	1	Yes	305589	8.8346
833-35PNR	327	1	1	Yes	382436	4.537	833-635NQ	332	1	1	Yes	305596	11.131
833-35PSQ	327	1	1	Yes	382443	4.8966	833-635NR	332	1	1	Yes	305657	10.426
833-35PSR	327	1	1	Yes	382450	4.2	833-635SQ	332	1	1	Yes	305725	-
833-3AF	325	1	1	Yes	375100	2.3207	833-635SR	332	1	1	Yes	306647	10.1864
833-3ANQ	325	1	1	Yes	375117	7.1736	833-63DF	244	1	1	Yes	376312	12.262
833-3ANR	325	1	1	Yes	375124	6.1736	833-63DIR	245	1	1	Yes	376329	16.092
833-3ASQ	325	1	1	Yes	382467	5.6191	833-63DNQ	245	1	1	Yes	376336	16.8433
833-3ASR	325	1	1	Yes	382474	4.3	833-63DNR	245	1	1	Yes	376343	15.741

Item No	Page No	Min Qty	Case Qty	UPC Bar-Coded	UPC 6-Digit	Weight (lbs.)	Item No	Page No	Min Qty	Case Qty	UPC Bar-Coded	UPC 6-Digit	Weight (lbs.)
833-63DSQ	245	1	1	Yes	306951	16.859	834-4ANQ	359	1	1	Yes	375414	5.3
833-63DSR	245	1	1	Yes	306968	16.62	834-4ANR	359	1	1	Yes	375421	4.3742
833-63F	330	1	1	Yes	374264	8.3788	834-4ASQ	359	1	1	Yes	307149	5.6528
833-63NQ	331	1	1	Yes	375254	11.9484	834-4ASR	359	1	1	Yes	307156	4.7981
833-63NR	331	1	1	Yes	375285	9.15	834-4DF	287	1	1	Yes	376435	7.0796
833-63SQ	331	1	1	Yes	306975	11.6836	834-4DHIR	287	1	10	Yes	376442	3.5164
833-63SR	331	1	1	Yes	306982	10.6578	834-4DHIR	289	1	10	Yes	376442	3.5164
833-64DF	244	1	1	Yes	376350	12.95	834-4DHNQ	287	1	10	Yes	376459	4.8502
833-64DIR	245	1	1	Yes	376367	16.305	834-4DHNQ	289	1	10	Yes	376459	4.8502
833-64DNQ	245	1	1	Yes	376374	16.7919	834-4DHNR	287	1	10	Yes	376466	3.7
833-64DNR	245	1	1	Yes	376381	15.7924	834-4DHNR	289	1	10	Yes	376466	3.7
833-64DSQ	245	1	1	Yes	306999	17.072	834-4DHSQ	287	1	1	Yes	307163	5.0336
833-64DSR	245	1	1	Yes	307002	16.833	834-4DHSQ	289	1	1	Yes	307163	5.0336
833-64F	330	1	4	Yes	374707	8.8693	834-4DHSR	287	1	1	Yes	307170	4
833-64NQ	331	1	1	Yes	375315	12.1614	834-4DHSR	289	1	1	Yes	307170	4
833-64NR	331	1	1	Yes	374370	11.1614	834-4DIR	287	1	1	Yes	376473	10.494
833-64SQ	331	1	1	Yes	307019	11.8966	834-4DNQ	287	1	1	Yes	376480	11.8168
833-64SR	331	1	1	Yes	307026	10.8772	834-4DNR	287	1	1	Yes	376497	11
834-3AF	359	1	10	Yes	374684	1.5872	834-4DSQ	287	1	1	Yes	307187	11.9371
834-3ANQ	359	1	1	Yes	375346	5.6573	834-4DSR	287	1	1	Yes	307194	8.8881
834-3ANR	359	1	1	Yes	375353	4.2608	834-4HNQ	359	1	10	Yes	374165	3.8571
834-3ASQ	359	1	1	Yes	307033	5.5669	834-4HNR	359	1	10	Yes	373915	2.2846
834-3ASR	359	1	1	Yes	307040	4.6847	834-4HSQ	359	1	10	Yes	307224	3.67
834-3DF	287	1	1	Yes	376398	7.1696	834-4HSR	359	1	10	Yes	307231	2.7085
834-3DHNQ	298	1	1	Yes	714206	4.1082	834-4PF	359	1	10	Yes	373892	1.9006
834-3DHNR	298	1	1	Yes	315687	31.6	834-4PNQ	359	1	1	Yes	375469	5.9707
834-3DHSQ	298	1	1	Yes	714220	3.7782	834-4PNR	359	1	1	Yes	365187	4.65
834-3DHSR	298	1	1	Yes	714213	3.0682	834-4PSQ	359	1	1	Yes	307248	5.72
834-3DIR	287	1	1	Yes	376404	10.7071	834-4PSR	359	1	1	Yes	307255	4.85
834-3DNQ	287	1	1	Yes	376411	12.8062	834-4SF	289	1	1	Yes	307262	-
834-3DNR	287	1	1	Yes	376428	11.1554	834-4SHSQ	289	1	1	Yes	307279	4.9513
834-3DSQ	287	1	1	Yes	307057	12.0314	834-4SHSR	289	1	1	Yes	307286	3.75
834-3DSR	287	1	1	Yes	307064	11.2272	834-4SSQ	290	1	1	Yes	307293	13.5515
834-3HNQ	362	1	1	Yes	315489	-	834-4SSR	290	1	1	Yes	307323	11.55
834-3HNR	362	1	10	Yes	314727	2.1279	834-63DF	288	1	1	Yes	377869	7.4196
834-3HSQ	362	1	1	Yes	315496	-	834-63DIR	289	1	1	Yes	306944	10.8461
834-3HSR	362	1	1	Yes	315502	-	834-63DNQ	289	1	1	Yes	306937	12.3089
834-3PF	359	1	10	Yes	374219	1.6894	834-63DNR	289	1	1	Yes	306920	10.9081
834-3PNQ	359	1	1	Yes	374622	5.8107	834-63DSQ	289	1	1	Yes	307330	12.2814
834-3PNR	359	1	1	Yes	374196	4.4151	834-63DSR	289	1	1	Yes	307347	11.4771
834-3PSQ	359	1	1	Yes	307071	5.6744	834-64DF	288	1	1	Yes	306913	9.1489
834-3PSR	359	1	1	Yes	307088	4.75	834-64DIR	289	1	1	Yes	306906	12.5755
834-3SF	289	1	1	Yes	307095	-	834-64DNQ	289	1	1	Yes	306890	14.0385
834-3SSQ	290	1	1	Yes	307125	-	834-64DNR	289	1	1	Yes	306883	12.6375
834-3SSR	290	1	1	Yes	307132	-	834-64DSQ	289	1	1	Yes	307354	14.0108
834-49DF	288	1	1	Yes	331076	8.2494	834-64DSR	289	1	1	Yes	307361	11.25
834-49DIR	288	1	1	Yes	474094	16.8326	834-6DF	288	1	1	Yes	380715	14.8
834-49DNR	288	1	1	Yes	327734	17.0498	834-6DHIR	288	1	1	Yes	380722	7.65
834-49DSR	288	1	1	Yes	331243	16.8572	834-6DHNR	288	1	1	Yes	312419	7.3984
834-4AF	359	1	10	Yes	374691	1.7006	834-6DHSR	288	1	1	Yes	316288	6.85

Supply

Drainage

Support

Specialties

Appendix

# Numerical Index

Supply

Drainage

Support

Specialties

Appendix

Item No	Page No	Min Qty	Case Qty	UPC Bar-Coded	UPC 6-Digit	Weight (lbs.)	Item No	Page No	Min Qty	Case Qty	UPC Bar-Coded	UPC 6-Digit	Weight (lbs.)
834-6DIR	288	1	1	Yes	380739	23	<b>835-3</b>	321	1	25	Yes	207784	0.168
834-6DNR	288	1	1	Yes	312426	18.935	<b>835-3</b>	326	1	25	Yes	207784	0.168
834-6DSR	288	1	1	Yes	310781	0.1	<b>835-3</b>	327	1	25	Yes	207784	0.168
835-2	163	1	50	Yes	207814	0.072	<b>835-3</b>	329	1	25	Yes	207784	0.168
835-2	318	1	50	Yes	207814	0.072	<b>835-3</b>	330	1	25	Yes	207784	0.168
835-2	319	1	50	Yes	207814	0.072	<b>835-3</b>	331	1	25	Yes	207784	0.168
835-2	321	1	50	Yes	207814	0.072	<b>835-3</b>	332	1	25	Yes	207784	0.168
835-2	326	1	50	Yes	207814	0.072	<b>835-3</b>	333	1	25	Yes	207784	0.168
835-2	327	1	50	Yes	207814	0.072	<b>835-3</b>	334	1	25	Yes	207784	0.168
835-2	329	1	50	Yes	207814	0.072	<b>835-3</b>	335	1	25	Yes	207784	0.168
835-2	330	1	50	Yes	207814	0.072	<b>835-3</b>	336	1	25	Yes	207784	0.168
835-2	331	1	50	Yes	207814	0.072	<b>835-3</b>	337	1	25	Yes	207784	0.168
835-2	332	1	50	Yes	207814	0.072	<b>835-3</b>	339	1	25	Yes	207784	0.168
835-2	333	1	50	Yes	207814	0.072	<b>835-3</b>	340	1	25	Yes	207784	0.168
835-2	334	1	50	Yes	207814	0.072	<b>835-3</b>	415	1	25	Yes	207784	0.168
835-2	335	1	50	Yes	207814	0.072	<b>835-3</b>	428	1	25	Yes	207784	0.168
835-2	336	1	50	Yes	207814	0.072	<b>835-3</b>	429	1	25	Yes	207784	0.168
835-2	337	1	50	Yes	207814	0.072	<b>835-35</b>	163	1	25	Yes	207821	0.23
835-2	339	1	50	Yes	207814	0.072	<b>835-35</b>	321	1	25	Yes	207821	0.23
835-2	340	1	50	Yes	207814	0.072	<b>835-35</b>	333	1	25	Yes	207821	0.23
835-2	407	1	50	Yes	207814	0.072	<b>835-35</b>	334	1	25	Yes	207821	0.23
835-2	408	1	50	Yes	207814	0.072	<b>835-35</b>	335	1	25	Yes	207821	0.23
835-2	409	1	50	Yes	207814	0.072	<b>835-35</b>	336	1	25	Yes	207821	0.23
835-2	410	1	50	Yes	207814	0.072	<b>835-35</b>	337	1	25	Yes	207821	0.23
835-2	411	1	50	Yes	207814	0.072	<b>835-35</b>	340	1	25	Yes	207821	0.23
835-2	411	1	50	Yes	207814	0.072	<b>835-35</b>	415	1	25	Yes	207821	0.23
835-2	412	1	50	Yes	207814	0.072	<b>835-35CQ</b>	253	1	25	Yes	726544	-
835-2	413	1	50	Yes	207814	0.072	<b>835-35CQ</b>	260	1	25	Yes	726544	-
835-2	414	1	50	Yes	207814	0.072	<b>835-3CQ</b>	237	1	25	Yes	726537	-
835-2	416	1	50	Yes	207814	0.072	<b>835-3CQ</b>	238	1	25	Yes	726537	-
835-2	417	1	50	Yes	207814	0.072	<b>835-3CQ</b>	240	1	25	Yes	726537	-
835-2	418	1	50	Yes	207814	0.072	<b>835-3CQ</b>	241	1	25	Yes	726537	-
835-2	419	1	50	Yes	207814	0.072	<b>835-3CQ</b>	243	1	25	Yes	726537	-
835-2	419	1	50	Yes	207814	0.072	<b>835-3CQ</b>	244	1	25	Yes	726537	-
835-2	420	1	50	Yes	207814	0.072	<b>835-3CQ</b>	245	1	25	Yes	726537	-
835-2	420	1	50	Yes	207814	0.072	<b>835-3CQ</b>	246	1	25	Yes	726537	-
835-2	428	1	50	Yes	207814	0.072	<b>835-3CQ</b>	253	1	25	Yes	726537	-
835-2	428	1	50	Yes	207814	0.072	<b>835-3CQ</b>	254	1	25	Yes	726537	-
835-2	429	1	50	Yes	207814	0.072	<b>835-3CQ</b>	260	1	25	Yes	726537	-
835-2CQ	238	1	50	Yes	726520	-	<b>835-4</b>	163	1	20	Yes	202208	0.2525
835-2CQ	243	1	50	Yes	726520	-	<b>835-4</b>	318	1	20	Yes	202208	0.2525
835-2CQ	244	1	50	Yes	726520	-	<b>835-4</b>	321	1	20	Yes	202208	0.2525
835-2CQ	245	1	50	Yes	726520	-	<b>835-4</b>	326	1	20	Yes	202208	0.2525
835-2CQ	246	1	50	Yes	726520	-	<b>835-4</b>	329	1	20	Yes	202208	0.2525
835-2CQ	253	1	50	Yes	726520	-	<b>835-4</b>	331	1	20	Yes	202208	0.2525
835-2CQ	254	1	50	Yes	726520	-	<b>835-4</b>	333	1	20	Yes	202208	0.2525
835-2CQ	260	1	50	Yes	726520	-	<b>835-4</b>	334	1	20	Yes	202208	0.2525
835-3	163	1	25	Yes	207784	0.168	<b>835-4</b>	335	1	20	Yes	202208	0.2525
835-3	318	1	25	Yes	207784	0.168	<b>835-4</b>	336	1	20	Yes	202208	0.2525
835-3	319	1	25	Yes	207784	0.168	<b>835-4</b>	340	1	20	Yes	202208	0.2525



Item No	Page No	Min Qty	Case Qty	UPC Bar-Coded	UPC 6-Digit	Weight (lbs.)	Item No	Page No	Min Qty	Case Qty	UPC Bar-Coded	UPC 6-Digit	Weight (lbs.)
835-4CQ	237	1	20	Yes	726551	-	837-TR	308	1	15	Yes	727800	2.455
835-4CQ	239	1	20	Yes	726551	-	837-VB10	307	1	1	No	716095	-
835-4CQ	240	1	20	Yes	726551	-	837-VB12	307	1	1	No	716132	56.346
835-4CQ	241	1	20	Yes	726551	-	837-VB1L	307	1	1	No	716125	-
835-4CQ	243	1	20	Yes	726551	-	837-VB1R	307	1	1	No	716118	-
835-4CQ	245	1	20	Yes	726551	-	837-VB20	307	1	1	No	716101	-
835-4CQ	260	1	20	Yes	726551	-	837-VB21	307	1	1	No	716149	-
836-2	260	1	1	Yes	327703	10.95	837-VB22	307	1	1	No	716156	-
836-3	260	1	1	Yes	327710	9.05	837-VS10	306	1	1	No	715951	-
836-4	260	1	1	Yes	327741	11.1	837-VS10W	306	1	1	No	716163	-
836-6	260	1	1	Yes	724946	-	837-VS12	306	1	1	No	715968	74.53
837-06	307	1	1	Yes	726872	0.9	837-VS12W	306	1	1	No	716200	-
837-12	307	1	1	Yes	715890	1.6	837-VS1L	306	1	1	No	715975	-
837-7C15	309	1	1	No	725219	30.977	837-VS1LW	306	1	1	No	716187	-
837-7C18	309	1	1	No	725226	30.2	837-VS1R	306	1	1	No	715982	-
837-7C22	309	1	1	No	725233	33.003	837-VS1RW	306	1	1	No	716194	-
837-7CA15	309	1	1	No	725240	41.9	837-VS20	306	1	1	No	715999	-
837-7CA18	309	1	1	No	725264	43.03	837-VS20W	306	1	1	No	716170	-
837-7CA22	309	1	1	No	725271	43.926	837-VS21	306	1	1	No	716002	-
837-7D	310	1	1	No	716330	33.2	837-VS21W	306	1	1	No	716217	-
837-7D	311	1	1	No	716330	33.2	837-VS22	306	1	1	No	716019	85.38
837-7D2	311	1	1	No	716354	5	837-VS22W	306	1	1	No	716224	-
837-7P	309	1	1	No	716293	24.03	837-VX10	307	1	1	No	716026	-
837-7P	310	1	1	No	716293	24.03	837-VX12	307	1	1	No	716033	40.866
837-7P	311	1	1	No	716293	24.03	837-VX1L	307	1	1	No	716040	-
837-7P2	311	1	1	No	716316	32.407	837-VX1R	307	1	1	No	716057	-
837-7W	309	1	1	No	716378	5.1	837-VX20	307	1	1	No	716064	-
837-7W	310	1	1	No	716378	5.1	837-VX21	307	1	1	No	716071	-
837-7W	311	1	1	No	716378	5.1	837-VX22	307	1	1	No	716088	51.716
837-FH	308	1	30	Yes	727954	0.859	840-20ANR	429	1	10	Yes	300737	0.9172
837-FPA	308	1	1	Yes	727787	38.78	840-20PCQ	429	1	5	Yes	318794	1.2845
837-FPAH	308	1	1	Yes	727893	5.116	840-20PNQ	429	1	1	Yes	318800	0.01
837-HBD	306	1	1	No	715883	55.666	840-20PNR	429	1	10	Yes	300768	1.0955
837-HBL	306	1	1	No	715869	44.636	840-20PRBQ	429	1	5	Yes	318824	2.5334
837-HBR	306	1	1	No	715876	44.636	840-20PSQ	429	1	1	Yes	318817	-
837-HSD	305	1	1	No	715821	138.5	840-27A	429	20	20	Yes	351579	0.4077
837-HSDW	305	1	1	No	715920	74.5	840-27P	429	20	20	Yes	300775	0.4885
837-HSL	305	1	1	No	715807	74.5	840-2A	429	1	20	Yes	300782	0.4077
837-HSLW	305	1	1	No	715913	74.5	840-2APK	429	10	10	Yes	300546	0.447
837-HSR	305	1	1	No	715814	74.5	840-2P	429	20	20	Yes	300799	0.4933
837-HSRW	305	1	1	No	715906	78.3	840-2PPK	429	10	10	Yes	300508	0.5573
837-HXD	305	1	1	No	715852	40.186	840-30ANR	429	1	10	Yes	352514	0.8518
837-HXL	305	1	1	No	715838	29.156	840-30PNR	429	1	10	Yes	300812	1.045
837-HXR	305	1	1	No	715845	29.156	840-3A	429	1	20	Yes	300836	0.45
837-LEG	308	1	1	Yes	727855	10.95	840-3APK	429	10	10	Yes	300744	0.47
837-LEGHL	308	1	1	Yes	727831	-	840-3P	429	20	20	Yes	300843	0.5784
837-LEGHR	308	1	1	Yes	727848	-	840-3PPK	429	10	10	Yes	300706	0.6123
837-RA	308	1	35	Yes	727817	1.535	841-29P	428	12	12	Yes	351371	1.1033
837-RH	308	1	35	Yes	727824	1.105	841-29PNR	428	1	2	Yes	308733	2.225
837-TF	308	1	20	Yes	734815	0.43	841-2A	428	12	12	Yes	300201	0.9585

Supply

Drainage

Support

Specialties

Appendix

# Numerical Index

Supply

Drainage

Support

Specialties

Appendix

Item No	Page No	Min Qty	Case Qty	UPC Bar-Coded	UPC 6-Digit	Weight (lbs.)	Item No	Page No	Min Qty	Case Qty	UPC Bar-Coded	UPC 6-Digit	Weight (lbs.)
841-2AIR	428	1	1	Yes	308887	1.5298	842-3LP	321	1	10	Yes	301130	0.9321
841-2ANQ	428	1	1	Yes	308764	-	842-3LSQ	321	1	5	Yes	308016	1.9669
841-2ANR	428	1	1	Yes	352590	3.1058	842-3LSR	321	1	10	Yes	308023	1.3095
841-2APK	428	6	6	Yes	300201	0.9727	842-3PNQ	320	1	10	Yes	305756	2.4245
841-2ASQ	428	1	1	Yes	308849	-	842-3PNR	320	1	8	Yes	356437	2.1231
841-2ASR	428	1	1	Yes	308801	-	842-3PSQ	320	1	10	Yes	308030	2.605
841-2P	428	12	12	Yes	300188	1.1835	842-3PSR	320	1	8	Yes	308047	1.9938
841-2PIR	428	1	1	Yes	308870	2.3158	842-4ANQ	320	1	1	Yes	352934	3.5347
841-2PNQ	428	1	1	Yes	308757	3.2652	842-4ANR	320	1	10	Yes	351487	2.3899
841-2PNR	428	1	6	Yes	351388	3.4524	842-4ASQ	320	1	1	Yes	308054	3.3491
841-2PPK	428	6	6	Yes	300188	1.2415	842-4ASR	320	1	1	Yes	308061	3.1101
841-2PSQ	428	1	1	Yes	308832	3.0841	842-4LNQ	321	1	5	Yes	305770	3.079
841-2PSR	428	1	1	Yes	308795	1.9551	842-4LNR	321	1	10	Yes	305787	2.0603
841-39P	428	12	12	Yes	351395	1.2133	842-4LP	321	1	10	Yes	301253	1.0946
842-22I	260	1	2	Yes	352613	1.6234	842-4LSQ	321	1	1	Yes	308078	2.81
842-24I	260	1	2	Yes	351739	4.75	842-4LSR	321	1	10	Yes	308085	2.531
842-2ANQ	320	1	1	Yes	352651	2.6748	842-4PI	320	1	2	Yes	305794	2.8922
842-2ANR	320	1	10	Yes	300935	1.9651	842-4PNQ	320	1	10	Yes	301284	3.6835
842-2ASQ	320	1	1	Yes	307873	2.3298	842-4PNR	320	1	10	Yes	320421	2.5899
842-2ASR	320	1	1	Yes	307880	1.7251	842-4PSQ	320	1	1	Yes	308092	3.4979
842-2LNQ	321	1	5	Yes	300966	1.5366	842-4PSR	320	1	10	Yes	308122	2.455
842-2LNR	321	1	10	Yes	300973	1.2076	842-712A	453	10	10	Yes	313560	0.165
842-2LP	321	1	10	Yes	300980	0.5936	842-712P	453	10	10	Yes	313577	0.205
842-2LSQ	321	1	1	Yes	307897	1.2319	842-82AT	341	1	10	Yes	326287	0.3591
842-2LSR	321	1	1	Yes	307903	0.9923	842-82PT	341	1	10	Yes	326263	0.4551
842-2PNQ	320	1	10	Yes	301024	2.8131	842-83AT	341	1	10	Yes	351715	0.7423
842-2PNR	320	1	10	Yes	356420	2.0768	842-83PT	341	1	10	Yes	326362	1.0353
842-2PSQ	320	1	10	Yes	307910	2.585	842-84AT	341	1	10	Yes	353030	1.016
842-2PSR	320	1	10	Yes	307927	1.8368	842-84PT	341	1	10	Yes	326461	1.3204
842-36ANQ	320	1	1	Yes	352736	3.4213	842-SCS2	340	1	1	Yes	309891	0.9153
842-36ANR	320	1	1	Yes	351630	2.2253	842-SCS3	340	1	10	Yes	309884	1.4653
842-36ASQ	320	1	1	Yes	307934	3.2357	842-SCS4	340	1	10	Yes	309402	0.845
842-36ASR	320	1	1	Yes	307941	2.9455	842-SCSQ2	340	1	1	Yes	309877	-
842-36LNQ	321	1	5	Yes	351432	3.1881	842-SCSQ3	340	1	1	Yes	309860	-
842-36LNR	321	1	10	Yes	306678	2.1383	842-SCSQ4	340	1	1	Yes	309853	-
842-36LP	321	1	1	Yes	352781	1.1576	842-SD4	340	1	1	Yes	310958	0.95
842-36LSQ	321	1	1	Yes	307958	-	842-SI2	340	1	1	Yes	353054	1.6094
842-36LSR	321	1	10	Yes	307965	1.618	842-SI3	340	1	10	Yes	353061	2.3248
842-36PI	320	1	2	Yes	352811	5.8445	842-SI4	340	1	2	Yes	351845	3.1134
842-36PNQ	320	1	10	Yes	351364	3.593	842-SN2	340	1	20	Yes	353078	0.2575
842-36PNR	320	1	10	Yes	306685	2.397	842-SN3	340	1	10	Yes	301451	1.1021
842-36PSQ	320	1	1	Yes	307972	3.4074	842-SN4	340	1	20	Yes	301468	0.8375
842-36PSR	320	1	10	Yes	307989	2.26	842-SNQ2	340	1	1	Yes	309846	0.0001
842-3ANQ	320	1	1	Yes	352866	2.7285	842-SNQ3	340	1	1	Yes	309839	2.1007
842-3ANR	320	1	8	Yes	352033	1.99	842-SNQ4	340	1	20	Yes	376039	1.2515
842-3ASQ	320	1	1	Yes	307996	2.3835	842-SP2	340	1	1	Yes	353085	0.2725
842-3ASR	320	1	1	Yes	308009	1.75	842-SP3	340	1	10	Yes	353092	0.4071
842-3LNQ	321	1	5	Yes	305749	2.2517	842-SP4	340	1	10	Yes	353108	0.34
842-3LNR	321	1	10	Yes	301123	1.7444	842-SS2	340	1	10	Yes	353115	0.261
842-3LNRPK	321	5	5	Yes	320315	1.842	842-SS3	340	1	10	Yes	353122	0.3147

Item No	Page No	Min Qty	Case Qty	UPC Bar-Coded	UPC 6-Digit	Weight (lbs.)	Item No	Page No	Min Qty	Case Qty	UPC Bar-Coded	UPC 6-Digit	Weight (lbs.)
842-SS4	340	1	10	Yes	351883	0.2942	846-S7PK	433	3	3	Yes	306388	1.517
842-UM	321	1	1	Yes	308139	0.1815	846-S9PK	433	3	3	Yes	306401	1.6
842-UM	333	1	1	Yes	308139	0.1815	847-2	430	<b>20</b>	20	No	339256	0.155
842-UM	335	1	1	Yes	308139	0.1815	847-2PK1	430	5	5	Yes	301222	0.422
842-UM	336	1	1	Yes	308139	0.1815	847-3	430	<b>20</b>	20	No	306692	0.1996
843-2ANQ	322	1	1	Yes	353160	1.8452	847-3PK1	430	10	10	Yes	301239	0.4539
843-2ANR	322	1	10	Yes	306098	1.2974	847-4	430	<b>10</b>	10	No	301819	0.325
843-2AP	322	1	1	Yes	353177	0.6557	847-4PK1	430	10	10	Yes	301246	0.5931
843-2AS	322	1	10	Yes	353184	0.6126	847-7	430	10	10	Yes	301277	0.9919
843-2PNQ	322	1	5	Yes	301499	1.7471	847-7B	430	<b>20</b>	20	Yes	306111	0.9393
843-2PNR	322	1	10	Yes	305817	1.3726	847-9	430	1	10	Yes	301291	2.1433
843-2PP	322	1	1	Yes	301512	0.7757	850-234N	365	1	10	Yes	351968	4.1516
843-2PS	322	1	10	Yes	305824	0.6928	850-2I	365	1	6	Yes	301475	7.0343
843-3ANQ	322	1	10	Yes	353245	2.4011	850-2N	365	1	6	Yes	301871	4.4304
843-3ANR	322	1	1	Yes	353252	1.7054	850-2T	365	1	6	Yes	301888	1.6904
843-3AP	322	1	10	Yes	351876	0.8604	850-3I	365	1	4	Yes	301895	9.8063
843-3AS	322	1	1	Yes	353269	0.731	850-3N	365	1	6	Yes	301901	7.3549
843-3PNQ	322	1	10	Yes	351951	2.5261	850-3T	365	1	6	Yes	301918	2.6969
843-3PNR	322	1	10	Yes	305831	1.8304	850-4I	365	1	2	Yes	305855	12.7947
843-3PP	322	1	10	Yes	305848	0.9914	850-4IN	365	1	2	Yes	353443	15.575
843-3PS	322	1	10	Yes	306807	0.856	850-4N	365	1	6	Yes	306074	9.8086
843-4ANQ	322	1	1	Yes	353320	3.0459	850-4T	365	1	6	Yes	305862	3.4826
843-4ANR	322	1	4	Yes	353337	2.0176	850-9I	297	1	1	Yes	712165	44.35
843-4AS	322	1	1	Yes	353351	0.7497	850-9IN	297	1	1	Yes	712172	47.55
843-4PNQ	322	1	10	Yes	351906	3.1124	850-CI2	373	1	1	Yes	353467	2.2082
843-4PNR	322	1	4	Yes	301581	2.1126	850-CI3	373	1	1	Yes	353474	3.175
843-4PP	322	1	1	Yes	301598	1.197	850-CI4	373	1	1	Yes	353481	5.1484
843-4PS	322	1	4	Yes	306784	0.8897	850-CN2	372	1	10	Yes	353498	1.7564
844-02G	432	1	10	Yes	301611	1.2747	850-CN3	372	1	10	Yes	351975	2.0144
844-02SL	431	1	1	Yes	344212	2.05	850-CN4	372	1	1	Yes	353504	3.6878
844-04G	432	1	10	Yes	301635	3.075	850-CT2	372	1	10	Yes	353511	0.6485
844-04IQ	431	1	4	Yes	344120	8.4625	850-CT3	372	1	10	Yes	301956	7.0785
844-04SL	431	1	1	Yes	344236	9.9125	850-CT4	372	1	10	Yes	353528	1.2993
844-0G	432	1	10	Yes	301659	1.54	850-V105	342	1	25	Yes	314673	0.0487
844-0SL	431	1	1	Yes	344229	5.1	850-V106	342	1	25	Yes	314659	0.0585
844-S4	432	1	40	Yes	301703	1.2397	850-V109	342	1	1	Yes	314642	0.1837
845-2APK	430	10	10	Yes	301321	0.0664	850-V407	342	1	1	Yes	314635	0.0103
845-2PPK	430	10	10	Yes	301307	0.0684	850-V415	342	1	1	Yes	314628	0.0153
845-3APK	430	10	10	Yes	301369	0.1416	850-V425	342	1	1	Yes	314611	0.0278
845-3PPK	430	10	10	Yes	301345	0.1436	850-VW1	342	<b>10</b>	10	Yes	351920	0.0351
845-4APK	430	10	10	Yes	301406	0.189	850-VW4	342	<b>10</b>	10	Yes	353535	0.0451
845-4PPK	430	10	10	Yes	301383	0.2378	851-24I	296	1	2	Yes	305879	11.8315
846-S11PK	433	3	3	Yes	306425	1.768	851-24N	296	1	2	Yes	351944	8.5491
846-S13PK	433	3	3	Yes	306449	1.9183	851-24T	296	1	2	Yes	353627	6.1907
846-S15PK	433	3	3	Yes	306463	1.6567	851-33N	364	1	2	Yes	353702	3.0961
846-S17PK	433	3	3	Yes	306562	2.25	851-33T	364	1	2	Yes	353719	1.4622
846-S19PK	433	3	3	Yes	306661	2.967	851-34I	364	1	2	Yes	305886	8.3135
846-S1PK	433	3	3	Yes	306302	0.765	851-34N	364	1	2	Yes	305893	5.0168
846-S3PK	433	3	3	Yes	306326	0.9357	851-34T	364	1	2	Yes	306722	2.6568
846-S5PK	433	3	3	Yes	306364	1.271	851-36I	364	1	2	Yes	353740	14.4978

Supply

Drainage

Support

Specialties

Appendix

# Numerical Index

Supply

Drainage

Support

Specialties

Appendix

Item No	Page No	Min Qty	Case Qty	UPC Bar-Coded	UPC 6-Digit	Weight (lbs.)	Item No	Page No	Min Qty	Case Qty	UPC Bar-Coded	UPC 6-Digit	Weight (lbs.)
851-36IN	364	1	2	Yes	353757	18.3759	852-4ASQ	360	1	1	Yes	308238	4.3741
851-36N	364	1	2	Yes	353771	8.2747	852-4ASR	360	1	1	Yes	308245	3.4509
851-36T	364	1	2	Yes	353788	4.6474	852-4LI	361	1	2	Yes	305961	5.2625
851-43N	364	1	2	Yes	305909	3.1681	852-4LNQ	360	1	1	Yes	302274	3.7997
851-43T	364	1	2	Yes	302014	1.5542	852-4LNR	360	1	10	Yes	302281	2.4886
851-44I	364	1	2	Yes	305916	8.2555	852-4LNRPK	360	5	5	Yes	350411	2.5328
851-44N	364	1	2	Yes	302038	4.7098	852-4LP	361	1	1	Yes	350763	1.3668
851-44T	364	1	2	Yes	356512	2.5988	852-4LSQ	361	1	1	Yes	308252	0.7232
851-46I	364	1	2	Yes	302052	15.7781	852-4LSR	361	1	1	Yes	308269	2.9535
851-46IN	364	1	2	Yes	351692	19.7099	852-4PI	360	1	2	Yes	305992	3.4
851-46N	364	1	2	Yes	302069	9.6087	852-4PNQ	360	1	2	Yes	306036	4.6062
851-46T	364	1	2	Yes	306746	4.5875	852-4PNR	360	1	10	Yes	350428	3.4765
851-64I	296	1	2	Yes	351708	11.3494	852-4PSQ	360	1	2	Yes	308276	4.65
851-64N	296	1	2	Yes	351746	8.0901	852-4PSR	360	1	10	Yes	308283	3.525
851-64T	296	1	2	Yes	353900	5.7301	852-CD4	373	1	10	Yes	321183	1.2436
851-66I	296	1	2	Yes	351814	24.1451	852-CI3	373	1	1	Yes	354549	2.3
851-66N	296	1	2	Yes	353931	15.972	852-CI4	373	1	5	Yes	354556	3.65
851-66T	296	1	2	Yes	353948	13.8785	852-CN2	372	1	10	Yes	354563	1.279
851-CI3	373	1	1	Yes	353955	1.5	852-CN3	372	1	10	Yes	354570	1.4809
851-CI4	373	1	1	Yes	353962	2.23	852-CN4	372	1	10	Yes	350794	1.8551
851-CI6	373	1	10	Yes	353979	3.5811	852-CP3	373	1	1	Yes	354594	0.5809
851-CI8	373	1	10	Yes	353986	5.1911	852-CP4	373	1	1	Yes	354600	0.8051
851-CN3	372	1	10	Yes	351838	1.167	852-CS3	373	1	1	Yes	316882	-
851-CN4	372	1	10	Yes	351654	1.7513	852-CS4	373	1	1	Yes	316899	-
851-CN6	372	1	10	Yes	353993	3.0811	852-CT4	372	1	2	Yes	354631	0.8651
851-CN8	372	1	10	Yes	354006	3.9011	852-HCD4	373	1	1	Yes	325914	2.66
851-CT3	372	1	10	Yes	302113	0.427	852-HCN4	372	1	1	Yes	325921	-
851-CT4	372	1	10	Yes	354013	0.6522	853-F23I	299	1	27	Yes	718341	1.53
851-CT6	372	1	10	Yes	351760	1.1811	853-F24I	299	1	16	Yes	718358	2.674
851-CT8	372	1	10	Yes	354020	1.3111	853-F26I	299	1	4	Yes	718365	7.165
852-2LNR	360	1	10	Yes	302168	1.2355	853-T23I	299	1	6	Yes	718389	5.478
852-3AI	360	1	1	Yes	354280	2.7876	853-T24I	299	1	4	Yes	718396	8.731
852-3ANQ	360	1	1	Yes	354297	4.2461	853-T26I	299	1	1	Yes	718402	22.226
852-3ANR	360	1	5	Yes	350343	2.7633	853-T28I	299	1	1	Yes	718419	35.724
852-3ASQ	360	1	1	Yes	308153	4.214	854-23I	292	1	1	No	718792	10.995
852-3ASR	360	1	5	Yes	308160	3.29	854-23IN	292	1	1	No	718846	11.785
852-3LI	361	1	2	Yes	351784	4.2123	854-23INQ	292	1	1	No	718976	11.86
852-3LNQ	360	1	5	Yes	351791	2.9909	854-23IQ	292	1	1	No	718945	-
852-3LNR	360	1	10	Yes	302182	1.928	854-23IS	293	1	1	No	718891	-
852-3LP	361	1	10	Yes	354372	1.0551	854-23NQ	291	1	1	No	735959	10.505
852-3LSQ	361	1	1	Yes	308177	2.6699	854-23NR	291	1	1	No	727411	10
852-3LSR	361	1	10	Yes	308184	1.9208	854-23SR	291	1	1	No	727466	10.745
852-3PI	360	1	2	Yes	350695	2.9593	854-24I	292	1	1	No	718808	11.395
852-3PNQ	360	1	2	Yes	350725	4.4178	854-24IN	292	1	1	No	718853	12.185
852-3PNR	360	1	5	Yes	350329	2.935	854-24INQ	292	1	1	No	718983	12.26
852-3PSQ	360	1	1	Yes	308191	4.3857	854-24IQ	292	1	1	No	718952	-
852-3PSR	360	1	1	Yes	308221	3.38	854-24IS	293	1	1	No	718907	-
852-4AI	360	1	1	Yes	350749	2.9872	854-24NQ	291	1	1	No	727442	10.905
852-4ANQ	360	1	1	Yes	354426	4.4062	854-24NR	291	1	1	No	727428	10
852-4ANR	360	1	10	Yes	350442	2.8865	854-24SR	291	1	1	No	727473	11.145

Item No	Page No	Min Qty	Case Qty	UPC Bar-Coded	UPC 6-Digit	Weight (lbs.)	Item No	Page No	Min Qty	Case Qty	UPC Bar-Coded	UPC 6-Digit	Weight (lbs.)
854-26I	292	1	1	No	718815	-	860-2A	323	1	1	Yes	354655	4.2296
854-26IN	292	1	1	No	718860	-	860-2AI	323	1	1	Yes	354662	15.3775
854-26IS	293	1	1	No	718914	-	860-2AN	323	1	1	Yes	354679	8.965
854-28I	292	1	1	No	718822	31.2754	860-2AZ	323	1	1	Yes	370143	9.2165
854-28IN	292	1	1	No	718877	-	860-2P	323	1	4	Yes	350817	5.5076
854-28IS	293	1	1	No	718921	-	860-2PI	323	1	1	Yes	354693	14.4
854-63I	294	1	1	No	719003	-	860-2PN	323	1	1	Yes	302380	9.1875
854-63IN	295	1	1	No	719058	-	860-2PZ	323	1	4	Yes	371256	9.5915
854-63INQ	295	1	1	No	719188	-	860-3A	323	1	4	Yes	350855	3.9296
854-63IQ	294	1	1	No	719157	-	860-3AI	323	1	2	Yes	350862	15.0775
854-63IS	295	1	1	No	719102	-	860-3AN	323	1	1	Yes	354709	8.315
854-63NQ	293	1	1	No	727527	12.555	860-3AZ	323	1	1	Yes	370099	8.5665
854-63NR	293	1	1	No	727497	12.535	860-3P	323	1	4	Yes	337030	5.108
854-63SR	294	1	1	No	727558	12.795	860-3PI	323	1	2	Yes	305626	15.0905
854-64I	294	1	1	No	719010	-	860-3PN	323	1	4	Yes	305114	9.04
854-64IN	295	1	1	No	719065	29.2044	860-3PZ	323	1	4	Yes	370129	9.2915
854-64INQ	295	1	1	No	719195	-	860-3SS	257	1	1	Yes	308290	7.15
854-64IQ	294	1	1	No	719164	-	860-3SS	271	1	1	Yes	308290	7.15
854-64IS	295	1	1	No	719119	-	860-3SSS	257	1	1	No	314246	2.3662
854-64NQ	293	1	1	No	727534	13.195	860-3SSS	271	1	1	No	314246	2.3662
854-64NR	293	1	1	No	727503	13.175	860-4A	323	1	1	Yes	354723	3.9246
854-64SR	294	1	1	No	727565	13.435	860-4AI	323	1	1	Yes	354730	14.9025
854-66I	294	1	1	No	719027	-	860-4AN	323	1	1	Yes	354747	8.66
854-66IN	295	1	1	No	719072	-	860-4AZ	323	1	4	Yes	369956	8.9115
854-66IS	295	1	1	No	719126	-	860-4P	323	1	4	Yes	352262	5.0626
854-68I	294	1	1	No	719034	-	860-4PI	323	1	2	Yes	352279	15.7025
854-68IN	295	1	1	No	719089	-	860-4PN	323	1	4	Yes	306753	8.995
854-68IS	295	1	1	No	719133	-	860-4PZ	323	1	4	Yes	369949	9.2465
858-63L	261	1	4	Yes	350923	4.334	860-4SS	257	1	1	Yes	375728	11.9
858-64L	261	1	4	Yes	302366	4.3038	860-4SS	271	1	1	Yes	375728	11.9
858-PG3	331	1	20	Yes	317810	0.325	860-4SSS	257	1	1	Yes	376572	5.6629
858-PG3	332	1	20	Yes	317810	0.325	860-4SSS	271	1	1	Yes	376572	5.6629
858-PG3CQ	240	1	1	Yes	726780	-	860-4SSU	257	1	1	Yes	314178	1.45
858-PG3CQ	245	1	1	Yes	726780	-	860-4SSU	271	1	1	Yes	314178	1.45
858-PG3CQ	246	1	1	Yes	726780	-	860-6	324	1	10	Yes	354761	0.2697
858-PG4	331	1	20	Yes	312006	0.107	860-62I	256	1	1	Yes	306609	30.3483
858-PG4CQ	240	1	1	Yes	726582	-	860-62N	255	1	1	Yes	306593	24.8683
858-PG4CQ	245	1	1	Yes	726582	-	860-62Z	256	1	1	Yes	369659	25.1198
860-22I	255	1	1	Yes	306876	30.65	860-63I	256	1	1	Yes	306579	28.533
860-22N	255	1	1	Yes	306869	26.05	860-63N	255	1	1	Yes	306555	-
860-22Z	255	1	1	Yes	369987	26.3015	860-63Z	256	1	1	Yes	369635	26.7545
860-23I	255	1	1	Yes	306845	28.318	860-64I	256	1	1	Yes	306531	28.3
860-23N	255	1	1	Yes	306838	24.5983	860-64N	255	1	1	Yes	306524	25.9637
860-23Z	255	1	1	Yes	369994	24.8498	860-64Z	256	1	1	Yes	369628	-
860-24I	255	1	1	Yes	306814	28	860-6A	323	1	1	Yes	354778	5.9146
860-24N	255	1	1	Yes	306777	27.35	860-6AI	323	1	1	Yes	354785	15.3825
860-24Z	255	1	1	Yes	370006	24.75	860-6AN	323	1	1	Yes	354792	10.3
860-26I	255	1	1	Yes	306630	30.2867	860-6AZ	323	1	1	Yes	369970	10.7215
860-26N	255	1	1	Yes	306623	30.9	860-6P	323	1	1	Yes	350510	7.936
860-26Z	255	1	1	Yes	369840	26.385	860-6PI	323	1	2	Yes	350527	18.6875

Supply

Drainage

Support

Specialties

Appendix

# Numerical Index

Supply

Drainage

Support

Specialties

Appendix

Item No	Page No	Min Qty	Case Qty	UPC Bar-Coded	UPC 6-Digit	Weight (lbs.)	Item No	Page No	Min Qty	Case Qty	UPC Bar-Coded	UPC 6-Digit	Weight (lbs.)
860-6PN	323	1	1	Yes	354815	11.6244	860-R264I	257	1	1	No	718303	35.619
860-6PZ	323	1	1	Yes	369963	11.8759	860-R264IN	257	1	1	No	725844	-
860-C	324	1	10	Yes	350534	0.7882	860-R266I	257	1	1	No	718310	37.934
860-C	348	1	10	Yes	350534	0.7882	860-R266IN	257	1	1	No	725851	-
860-CI	324	1	10	Yes	369611	3.3416	860-RGN	324	1	1	Yes	350572	6.096
860-D	324	1	80	Yes	305695	0.282	860-RGN	348	1	1	Yes	350572	6.096
860-GA	324	1	12	Yes	350541	1.3883	860-RGN2	324	1	1	Yes	350589	5.13
860-GA2	324	1	1	Yes	354839	0.6435	860-RGN2	348	1	1	Yes	350589	5.13
860-GI	324	1	5	Yes	350558	9.4931	860-RGS	324	1	1	Yes	310644	6.096
860-GI	348	1	5	Yes	350558	9.4931	860-RGS	348	1	1	Yes	310644	6.096
860-GN	324	1	1	Yes	305503	4.68	860-RGS2	324	1	1	Yes	310651	5.13
860-GN	348	1	1	Yes	305503	4.68	860-RGS2	348	1	1	Yes	310651	5.13
860-GN2	324	1	1	Yes	302557	3.88	860-S	324	1	20	Yes	302786	1.033
860-GN2	348	1	1	Yes	302557	3.88	860-U	324	1	20	Yes	302618	0.858
860-GN3	348	1	1	Yes	305497	4.68	860-UM	324	1	5	Yes	304834	0.428
860-GP	324	1	16	Yes	302571	1.8451	860-UM	348	1	5	Yes	304834	0.428
860-GP2	324	1	10	Yes	304995	1.283	860-W2P	347	1	4	Yes	316370	5.4938
860-GPJ	324	1	16	Yes	305480	1.6194	860-W2PI	347	1	1	Yes	315991	16.2925
860-Q222I	256	1	1	No	723758	48.66	860-W2PN	347	1	1	Yes	316387	10.4284
860-Q222IN	256	1	1	No	725684	-	860-W2PX	347	1	4	Yes	316394	4.7384
860-Q223I	256	1	1	No	723765	50.24	860-W2PZ	347	1	1	Yes	316028	-
860-Q223IN	256	1	1	No	726841	-	860-W3P	347	1	4	Yes	315908	5.1713
860-Q224I	256	1	1	No	723772	50.05	860-W3PI	347	1	2	Yes	316004	15.3
860-Q224IN	256	1	1	No	725707	56.72	860-W3PN	347	1	4	Yes	316363	8.6
860-Q226I	256	1	1	No	723789	50.335	860-W3PX	347	1	4	Yes	316332	3.39
860-Q226IN	256	1	1	No	725714	-	860-W3PZ	347	1	1	Yes	316035	9.3351
860-Q228I	256	1	1	No	723796	49.091	860-W4P	347	1	4	Yes	316356	5.2
860-Q228IN	256	1	1	No	725721	-	860-W4PI	347	1	2	Yes	316011	15.35
860-Q262I	257	1	1	No	723802	48.046	860-W4PN	347	1	4	Yes	315984	8.9875
860-Q262IN	257	1	1	No	725738	-	860-W4PX	347	1	4	Yes	316349	3.305
860-Q263I	257	1	1	No	726858	49.479	860-W4PZ	347	1	4	Yes	316042	0.9362
860-Q263IN	257	1	1	No	725745	-	860-WGP	348	1	16	Yes	316059	1.8314
860-Q264I	257	1	1	No	723819	49.699	860-WGP2	348	1	10	Yes	316066	1.3135
860-Q264IN	257	1	1	No	725752	-	860-WGP3	348	1	10	Yes	316073	1.61
860-Q266I	257	1	1	No	723840	52.014	860-WGPJ	348	1	16	Yes	316080	2.1062
860-Q266IN	257	1	1	No	725769	-	860-WS	348	1	20	Yes	316097	1.006
860-R222I	256	1	1	No	718235	34.58	860-WU	348	1	20	Yes	316103	0.84
860-R222IN	256	1	1	No	725783	-	861-2P	345	1	1	Yes	350701	7.0593
860-R223I	256	1	1	No	718242	37.92	861-2PI	345	1	1	Yes	354860	16.3867
860-R223IN	256	1	1	No	725790	-	861-2PN	345	1	1	Yes	354877	15.5067
860-R224I	256	1	1	No	718259	35.97	861-2PR	345	1	1	Yes	713933	8.8777
860-R224IN	256	1	1	No	725806	40.525	861-2PX	345	1	3	Yes	305527	5.3067
860-R226I	256	1	1	No	718266	34.495	861-2PXR	345	1	3	Yes	708472	5.8933
860-R226IN	256	1	1	No	725813	-	861-2PZ	345	1	1	Yes	316479	-
860-R228I	256	1	1	No	718273	35.011	861-3P	345	1	1	Yes	302670	7.6896
860-R228IN	256	1	1	No	725820	41.041	861-3PI	345	1	1	Yes	354884	16.1495
860-R262I	257	1	1	No	718280	33.966	861-3PN	345	1	1	Yes	302731	15.6
860-R262IN	257	1	1	No	726834	-	861-3PR	345	1	1	Yes	713940	9.5795
860-R263I	257	1	1	No	718297	35.399	861-3PX	345	1	3	Yes	305534	5.3467
860-R263IN	257	1	1	No	725837	-	861-3PXR	345	1	3	Yes	708205	6.5951

Item No	Page No	Min Qty	Case Qty	UPC Bar-Coded	UPC 6-Digit	Weight (lbs.)	Item No	Page No	Min Qty	Case Qty	UPC Bar-Coded	UPC 6-Digit	Weight (lbs.)
861-3PZ	345	1	1	Yes	316486	16.637	861-GAQ2T	267	1	6	No	719850	4.092
861-4P	345	1	1	Yes	350503	8.9043	861-GAQ8F	268	1	6	No	719867	3.069
861-4PI	345	1	1	Yes	354891	16.2659	861-GAQ8H	268	1	6	No	719874	2.455
861-4PN	345	1	1	Yes	354907	16.8404	861-GAQ8T	268	1	6	No	719881	2.906
861-4PX	345	1	3	Yes	305541	5.3917	861-GAR2F	270	1	6	No	719898	4.911
861-4PZ	345	1	1	Yes	316493	-	861-GAR2H	270	1	6	No	719904	4.092
861-5	346	1	15	Yes	305558	1.846	861-GAR2T	270	1	6	No	719911	4.809
861-51	346	1	15	Yes	305602	1.1873	861-GAR8F	269	1	6	No	719928	2.906
861-51AR	346	1	10	Yes	735904	1.65	861-GAR8H	269	1	6	No	719935	1.842
861-51NR	346	1	3	Yes	350626	8.333	861-GAR8T	269	1	6	No	719942	2.251
861-51SR	346	1	3	Yes	316523	8.8	861-GNQ2F	265	1	1	No	719959	8.443
861-53	346	1	15	Yes	305619	1.5823	861-GNQ2F	266	1	1	No	719959	8.443
861-53N	346	1	1	Yes	302809	6.08	861-GNQ2F	267	1	1	No	719959	8.443
861-53NR	346	1	3	Yes	354914	9.4	861-GNQ2H	265	1	1	No	719966	5.234
861-53SR	346	1	1	Yes	316547	-	861-GNQ2H	266	1	1	No	719966	5.234
861-5AR	346	1	10	Yes	735898	2.15	861-GNQ2H	267	1	1	No	719966	5.234
861-5CI	346	1	3	Yes	350633	10.5211	861-GNQ2T	265	1	1	No	719973	6.763
861-5CIG	346	1	1	Yes	304827	8.32	861-GNQ2T	266	1	1	No	719973	6.763
861-5NR	346	1	3	Yes	302847	10.5211	861-GNQ2T	267	1	1	No	719973	6.763
861-5SR	346	1	1	Yes	316516	-	861-GNQ8F	268	1	1	No	719980	4.324
861-6	346	1	10	Yes	305565	0.2666	861-GNQ8H	268	1	1	No	719997	3.061
861-6	348	1	10	Yes	305565	0.2666	861-GNQ8T	268	1	1	No	720009	3.704
861-6P	345	1	1	Yes	354921	8.2288	861-GNR2F	270	1	1	No	720016	7.755
861-6PI	345	1	1	Yes	354938	16.2224	861-GNR2H	270	1	1	No	720023	5.052
861-6PN	345	1	1	Yes	354945	16.2224	861-GNR2T	270	1	1	No	720030	6.751
861-6PX	345	1	2	Yes	302861	4.7615	861-GNR8F	269	1	1	No	720047	2.799
861-6PZ	345	1	1	Yes	316509	-	861-GNR8H	269	1	1	No	720054	2.134
861-BQ2	265	1	1	No	719751	4.53	861-GNR8T	269	1	1	No	720061	2.523
861-BQ2	266	1	1	No	719751	4.53	861-Q2221	267	1	1	No	720078	35.65
861-BQ2	267	1	1	No	719751	4.53	861-Q2221A	267	1	1	No	720085	-
861-BQ8	268	1	1	No	719768	1.6	861-Q2221N	267	1	1	No	720092	-
861-BR2	270	1	1	No	719775	3.42	861-Q2226	265	1	1	No	720108	20.565
861-BR8	269	1	1	No	719782	1.19	861-Q2226A	265	1	1	No	720115	26
861-C	346	1	5	Yes	374790	0.7252	861-Q2226N	265	1	1	No	720122	-
861-CQ2	265	1	1	No	719799	7.76	861-Q2228	266	1	1	No	720139	23.02
861-CQ2	266	1	1	No	719799	7.76	861-Q2228A	266	1	1	No	720146	-
861-CQ2	267	1	1	No	719799	7.76	861-Q2228N	266	1	1	No	720153	-
861-CQ8	268	1	1	No	719805	3.38	861-Q2286	268	1	1	No	720160	14.017
861-CR2	270	1	1	No	719812	3.06	861-Q2286A	268	1	1	No	720177	-
861-CR8	269	1	1	No	719829	4.6	861-Q2286N	268	1	1	No	720184	-
861-D	346	1	80	Yes	302885	0.282	861-Q2321	267	1	1	No	720191	29.159
861-D	348	1	80	Yes	302885	0.282	861-Q2321A	267	1	1	No	720207	-
861-GAQ2F	265	1	6	No	719836	4.3	861-Q2321N	267	1	1	No	720214	-
861-GAQ2F	266	1	6	No	719836	4.3	861-Q2326	265	1	1	No	720221	20.565
861-GAQ2F	267	1	6	No	719836	4.3	861-Q2326A	265	1	1	No	720238	-
861-GAQ2H	265	1	6	No	719843	3.172	861-Q2326N	265	1	1	No	720245	-
861-GAQ2H	266	1	6	No	719843	3.172	861-Q2328	266	1	1	No	720252	23.02
861-GAQ2H	267	1	6	No	719843	3.172	861-Q2328A	266	1	1	No	720269	-
861-GAQ2T	265	1	6	No	719850	4.092	861-Q2328N	266	1	1	No	720276	-
861-GAQ2T	266	1	6	No	719850	4.092	861-Q2386	268	1	1	No	720283	12.8

Supply

Drainage

Support

Specialties

Appendix

# Numerical Index

Supply

Drainage

Support

Specialties

Appendix

Item No	Page No	Min Qty	Case Qty	UPC Bar-Coded	UPC 6-Digit	Weight (lbs.)	Item No	Page No	Min Qty	Case Qty	UPC Bar-Coded	UPC 6-Digit	Weight (lbs.)
861-Q2386A	268	1	1	No	720290	-	861-R2228	270	1	1	No	721518	17.7
861-Q2386N	268	1	1	No	720306	-	861-R2228A	270	1	1	No	721525	-
861-Q2421	267	1	1	No	720313	29.159	861-R2228N	270	1	1	No	721532	-
861-Q2421A	267	1	1	No	720320	-	861-R2286	269	1	1	No	721549	10.743
861-Q2421N	267	1	1	No	720337	-	861-R2286A	269	1	1	No	721556	-
861-Q2426	265	1	1	No	720344	20.565	861-R2286N	269	1	1	No	721563	-
861-Q2426A	265	1	1	No	720351	-	861-R2328	270	1	1	No	721570	21.1
861-Q2426N	265	1	1	No	720368	-	861-R2328A	270	1	1	No	721587	-
861-Q2428	266	1	1	No	720375	23.02	861-R2328N	270	1	1	No	721594	-
861-Q2428A	266	1	1	No	720382	-	861-R2386	269	1	1	No	721600	10.743
861-Q2428N	266	1	1	No	720399	-	861-R2386A	269	1	1	No	721617	-
861-Q2486	268	1	1	No	720405	14.017	861-R2386N	269	1	1	No	721624	-
861-Q2486A	268	1	1	No	720412	-	861-R2428	270	1	1	No	721631	22.55
861-Q2486N	268	1	1	No	720429	-	861-R2428A	270	1	1	No	721648	-
861-QF2221	267	1	1	No	720795	36.321	861-R2428N	270	1	1	No	721655	-
861-QF2221A	267	1	1	No	720801	-	861-R2486	269	1	1	No	721662	10.743
861-QF2221N	267	1	1	No	720818	-	861-R2486A	269	1	1	No	721679	-
861-QF2226	265	1	1	No	720825	31.205	861-R2486N	269	1	1	No	721686	-
861-QF2226A	265	1	1	No	720832	-	861-RF2228	270	1	1	No	721877	24.452
861-QF2226N	265	1	1	No	720849	47.1	861-RF2228A	270	1	1	No	721884	-
861-QF2228	266	1	1	No	720856	31.205	861-RF2228N	270	1	1	No	721891	-
861-QF2228A	266	1	1	No	720863	-	861-RF2286	269	1	1	No	721907	13.812
861-QF2228N	266	1	1	No	720870	-	861-RF2286A	269	1	1	No	721914	-
861-QF2286	268	1	1	No	720887	20.769	861-RF2286N	269	1	1	No	721921	-
861-QF2286A	268	1	1	No	720894	-	861-RF2328	270	1	1	No	721938	24.452
861-QF2286N	268	1	1	No	720900	-	861-RF2328A	270	1	1	No	721945	-
861-QF2321	267	1	1	No	720917	36.321	861-RF2328N	270	1	1	No	721952	-
861-QF2321A	267	1	1	No	720924	-	861-RF2386	269	1	1	No	721969	13.812
861-QF2321N	267	1	1	No	720931	-	861-RF2386A	269	1	1	No	721976	-
861-QF2326	265	1	1	No	720948	31.205	861-RF2386N	269	1	1	No	721983	-
861-QF2326A	265	1	1	No	720955	-	861-RF2428	270	1	1	No	721990	24.452
861-QF2326N	265	1	1	No	720962	-	861-RF2428A	270	1	1	No	722003	-
861-QF2328	266	1	1	No	720979	31.205	861-RF2428N	270	1	1	No	722010	-
861-QF2328A	266	1	1	No	720986	-	861-RF2486	269	1	1	No	722027	13.812
861-QF2328N	266	1	1	No	720993	-	861-RF2486A	269	1	1	No	722034	-
861-QF2386	268	1	1	No	721006	20.769	861-RF2486N	269	1	1	No	722041	-
861-QF2386A	268	1	1	No	721013	-	861-TA22	162	1	1	No	722232	2.27
861-QF2386N	268	1	1	No	721020	-	861-TA22	265	1	1	No	722232	2.27
861-QF2421	267	1	1	No	721037	36.321	861-TA22	266	1	1	No	722232	2.27
861-QF2421A	267	1	1	No	721044	-	861-TA22	267	1	1	No	722232	2.27
861-QF2421N	267	1	1	No	721051	-	861-TA22	268	1	1	No	722232	2.27
861-QF2426	265	1	1	No	721068	31.205	861-TA22	269	1	1	No	722232	2.27
861-QF2426A	265	1	1	No	721075	-	861-TA22	270	1	1	No	722232	2.27
861-QF2426N	265	1	1	No	721082	-	861-TA23	162	1	1	No	722249	3.32
861-QF2428	266	1	1	No	721099	31.205	861-TA23	265	1	1	No	722249	3.32
861-QF2428A	266	1	1	No	721105	-	861-TA23	266	1	1	No	722249	3.32
861-QF2428N	266	1	1	No	721112	-	861-TA23	267	1	1	No	722249	3.32
861-QF2486	268	1	1	No	721129	20.769	861-TA23	268	1	1	No	722249	3.32
861-QF2486A	268	1	1	No	721136	-	861-TA23	269	1	1	No	722249	3.32
861-QF2486N	268	1	1	No	721143	-	861-TA23	270	1	1	No	722249	3.32



Item No	Page No	Min Qty	Case Qty	UPC Bar-Coded	UPC 6-Digit	Weight (lbs.)	Item No	Page No	Min Qty	Case Qty	UPC Bar-Coded	UPC 6-Digit	Weight (lbs.)
861-TA24	162	1	1	No	722256	5.379	862-2410NRE	248	1	1	No	723956	-
861-TA24	265	1	1	No	722256	5.379	862-245NQ	247	1	1	No	716934	9.3
861-TA24	266	1	1	No	722256	5.379	862-245NR	247	1	1	No	716637	9
861-TA24	267	1	1	No	722256	5.379	862-245SQ	249	1	1	No	717535	-
861-TA24	268	1	1	No	722256	5.379	862-245SR	248	1	1	No	717238	-
861-TA24	269	1	1	No	722256	5.379	862-246NQ	247	1	1	No	716965	-
861-TA24	270	1	1	No	722256	5.379	862-246NR	247	1	1	No	716668	-
861-UM	346	1	5	Yes	302892	0.083	862-246SQ	249	1	1	No	717566	-
862-2210NQ	247	1	1	No	717030	-	862-246SR	249	1	1	No	717269	-
862-2210NR	247	1	1	No	716736	-	862-247I	249	1	1	No	718075	-
862-2210NRE	248	1	1	No	723864	-	862-247IN	249	1	1	No	717955	-
862-225NQ	247	1	1	No	716910	-	862-247NQ	247	1	1	No	716996	-
862-225NR	247	1	1	No	716613	8	862-247NR	247	1	1	No	716699	-
862-225SQ	249	1	1	No	717511	-	862-247NRE	248	1	1	No	724342	-
862-225SR	248	1	1	No	717214	8.262	862-248NQ	247	1	1	No	717023	-
862-226NQ	247	1	1	No	716941	-	862-248NR	247	1	1	No	716729	-
862-226NR	247	1	1	No	716644	-	862-249I	249	1	1	No	718105	-
862-226SQ	249	1	1	No	717542	-	862-249IN	249	1	1	No	717986	21.176
862-226SR	249	1	1	No	717245	-	862-410LNQ	258	1	4	Yes	716491	-
862-227I	249	1	1	No	718051	-	862-410LNR	258	1	8	Yes	716446	5.73
862-227IN	249	1	1	No	717931	-	862-410LNRE	258	1	8	Yes	716552	5.732
862-227NQ	247	1	1	No	716972	-	862-45LNQ	258	1	20	Yes	716453	-
862-227NR	247	1	1	No	716675	-	862-45LNR	258	1	20	Yes	716408	1.645
862-227NRE	248	1	1	No	717849	-	862-45LSQ	259	1	20	Yes	716538	2.396
862-228NQ	247	1	1	No	717009	-	862-45LSR	259	1	24	Yes	716507	1.922
862-228NR	247	1	1	No	716705	-	862-46LNQ	258	1	16	Yes	716460	-
862-229I	249	1	1	No	718082	-	862-46LNR	258	1	20	Yes	716415	1.94
862-229IN	249	1	1	No	717962	-	862-46LSQ	259	1	16	Yes	716521	3.331
862-2310NQ	247	1	1	No	717047	-	862-46LSR	259	1	20	Yes	716514	-
862-2310NR	247	1	1	No	716743	-	862-47LI	259	1	1	Yes	716569	-
862-2310NRE	248	1	1	No	723949	-	862-47LIN	259	1	4	Yes	716583	-
862-235NQ	247	1	1	No	716927	8.7	862-47LNQ	258	1	12	Yes	716477	2.98
862-235NR	247	1	1	No	716620	3.5555	862-47LNR	258	1	12	Yes	716422	3.03
862-235SQ	249	1	1	No	717528	-	862-47LNRE	258	1	8	Yes	716545	4.23
862-235SR	248	1	1	No	717221	9.097	862-48LNQ	258	1	8	Yes	716484	4.96
862-236NQ	247	1	1	No	716958	-	862-48LNR	258	1	8	Yes	716439	-
862-236NR	247	1	1	No	716651	-	862-49LI	259	1	1	Yes	716576	13.648
862-236SQ	249	1	1	No	717559	-	862-49LIN	259	1	1	Yes	716590	13.75
862-236SR	249	1	1	No	717252	-	862-6210NQ	250	1	1	No	717184	-
862-237I	249	1	1	No	718068	-	862-6210NR	250	1	1	No	716880	-
862-237IN	249	1	1	No	717948	-	862-6210NRE	251	1	1	No	723925	-
862-237NQ	247	1	1	No	716989	-	862-625NQ	250	1	1	No	717061	-
862-237NR	247	1	1	No	716682	-	862-625NR	250	1	1	No	716767	9.31
862-237NRE	248	1	1	No	724335	-	862-625SQ	251	1	1	No	717665	-
862-238NQ	247	1	1	No	717016	-	862-625SR	251	1	1	No	717368	-
862-238NR	247	1	1	No	716712	-	862-626NQ	250	1	1	No	717092	-
862-239I	249	1	1	No	718099	-	862-626NR	250	1	1	No	716798	-
862-239IN	249	1	1	No	717979	21.056	862-626SQ	251	1	1	No	717696	-
862-2410NQ	247	1	1	No	717054	-	862-626SR	251	1	1	No	717399	-
862-2410NR	247	1	1	No	716750	-	862-627I	252	1	1	No	718112	-

Supply

Drainage

Support

Specialties

Appendix

# Numerical Index

Supply

Drainage

Support

Specialties

Appendix

Item No	Page No	Min Qty	Case Qty	UPC Bar-Coded	UPC 6-Digit	Weight (lbs.)	Item No	Page No	Min Qty	Case Qty	UPC Bar-Coded	UPC 6-Digit	Weight (lbs.)
862-627IN	252	1	1	No	717993	-	862-B24	260	1	1	No	725974	6.73
862-627NQ	250	1	1	No	717122	-	862-B62	260	1	1	No	725981	7.1
862-627NR	250	1	1	No	716828	-	862-B63	260	1	1	No	726193	7.46
862-627NRE	251	1	1	No	717900	-	862-B64	260	1	1	No	725998	8.1
862-628NQ	250	1	1	No	717153	-	862-EX4	248	1	1	No	716606	-
862-628NR	250	1	1	No	716859	-	862-EX4	248	1	1	No	716606	-
862-629I	252	1	1	No	718143	-	862-EX4	249	1	1	No	716606	-
862-629IN	252	1	1	No	718020	-	862-EX4	249	1	1	No	716606	-
862-6310NQ	250	1	1	No	717191	-	862-EX4	250	1	1	No	716606	-
862-6310NR	250	1	1	No	716897	-	862-EX4	251	1	1	No	716606	-
862-6310NRE	251	1	1	No	726483	-	862-EX4	251	1	1	No	716606	-
862-635NQ	250	1	1	No	717078	-	862-EX4	252	1	1	No	716606	-
862-635NR	250	1	1	No	716774	9.105	862-EX4	258	1	1	No	716606	-
862-635SQ	251	1	1	No	717672	-	862-EX4	258	1	1	No	716606	-
862-635SR	251	1	1	No	717375	-	862-EX4	259	1	1	No	716606	-
862-636NQ	250	1	1	No	717108	-	862-EX4	259	1	1	No	716606	-
862-636NR	250	1	1	No	716804	-	863-22NQ	335	1	2	Yes	354983	11.2458
862-636SQ	251	1	1	No	717702	-	863-22NR	335	1	3	Yes	302908	8.72
862-636SR	251	1	1	No	717405	-	863-22SQ	335	1	1	Yes	308320	10.4069
862-637I	252	1	1	No	718129	-	863-22SR	335	1	1	Yes	308337	10.0658
862-637IN	252	1	1	No	718006	-	863-23NQ	335	1	2	Yes	355027	9.41
862-637NQ	250	1	1	No	717139	-	863-23NR	335	1	2	Yes	350640	8.1034
862-637NR	250	1	1	No	716835	-	863-23SQ	335	1	1	Yes	308344	8.6755
862-637NRE	251	1	1	No	717917	-	863-23SR	335	1	1	Yes	308351	8.4169
862-638NQ	250	1	1	No	717160	-	863-24NQ	335	1	1	Yes	355065	10.8914
862-638NR	250	1	1	No	716866	-	863-24NR	335	1	1	Yes	355072	9.8914
862-639I	252	1	1	No	718150	-	863-24SQ	335	1	1	Yes	308368	10.1755
862-639IN	252	1	1	No	718037	-	863-24SR	335	1	2	Yes	308375	9.9365
862-6410NQ	250	1	1	No	717207	-	863-325NQ	334	1	2	Yes	355119	4.3377
862-6410NR	250	1	1	No	716903	-	863-325NR	334	1	6	Yes	302915	2.7833
862-6410NRE	251	1	1	No	723963	-	863-325SQ	334	1	2	Yes	308665	3.5217
862-645NQ	250	1	1	No	717085	-	863-325SR	334	1	6	Yes	308535	2.7817
862-645NR	250	1	1	No	716781	-	863-32NQ	333	1	2	Yes	355164	4.9857
862-645SQ	251	1	1	No	717689	-	863-32NR	333	1	6	Yes	355171	3.9668
862-645SR	251	1	1	No	717382	-	863-32SQ	333	1	2	Yes	308672	4.2561
862-646NQ	250	1	1	No	717115	-	863-32SR	333	1	6	Yes	308542	3.8796
862-646NR	250	1	1	No	716811	-	863-335CQ	415	1	2	Yes	312235	3.6867
862-646SQ	251	1	1	No	717719	-	863-335CR	415	1	1	Yes	312228	2.8167
862-646SR	251	1	1	No	717412	-	863-335NQ	334	1	2	Yes	355225	4.5983
862-647I	252	1	1	No	718136	-	863-335NR	414	1	2	Yes	355225	4.5983
862-647IN	252	1	1	No	718013	-	863-335NR	334	1	6	Yes	350657	3.7977
862-647NQ	250	1	1	No	717146	-	863-335NR	414	1	6	Yes	350657	3.7977
862-647NR	250	1	1	No	716842	-	863-335RBQ	415	1	2	Yes	309433	3.4587
862-647NRE	251	1	1	No	724359	-	863-335RBR	415	1	6	Yes	309440	3.3078
862-648NQ	250	1	1	No	717177	-	863-335SQ	334	1	2	Yes	308689	3.6867
862-648NR	250	1	1	No	716873	-	863-335SQ	415	1	2	Yes	308689	3.6867
862-649I	252	1	1	No	718167	-	863-335SR	334	1	6	Yes	308559	2.8167
862-649IN	252	1	1	No	718044	-	863-335SR	415	1	6	Yes	308559	2.8167
862-B22	260	1	1	No	725950	6.34	863-33NQ	333	1	1	Yes	355270	5.1463
862-B23	260	1	1	No	725967	6.61	863-33NR	333	1	6	Yes	355287	4.0507

Item No	Page No	Min Qty	Case Qty	UPC Bar-Coded	UPC 6-Digit	Weight (lbs.)	Item No	Page No	Min Qty	Case Qty	UPC Bar-Coded	UPC 6-Digit	Weight (lbs.)
863-33SQ	333	1	2	Yes	308696	4.4211	863-FA	318	1	12	Yes	355775	0.91
863-33SR	333	1	6	Yes	308566	4.0446	863-FA	319	1	12	Yes	355775	0.91
863-345NQ	334	1	2	Yes	355331	4.6483	863-FA	321	1	12	Yes	355775	0.91
863-345NR	334	1	6	Yes	355348	3.7583	863-FA	322	1	12	Yes	355775	0.91
863-34NQ	333	1	2	Yes	355393	5.1963	863-FA	326	1	12	Yes	355775	0.91
863-34NR	333	1	6	Yes	355409	4.1007	863-FA	327	1	12	Yes	355775	0.91
863-34SQ	333	1	2	Yes	308702	4.4711	863-FA	329	1	12	Yes	355775	0.91
863-34SR	333	1	6	Yes	308573	4.0946	863-FA	330	1	12	Yes	355775	0.91
863-425NQ	334	1	2	Yes	350688	4.7183	863-FA	331	1	12	Yes	355775	0.91
863-425NR	334	1	6	Yes	302939	3.0417	863-FA	332	1	12	Yes	355775	0.91
863-425SQ	334	1	2	Yes	308580	3.8067	863-FA	333	1	12	Yes	355775	0.91
863-425SR	334	1	1	Yes	308467	3.0692	863-FA	334	1	12	Yes	355775	0.91
863-42NQ	333	1	2	Yes	351159	5.4333	863-FA	335	1	12	Yes	355775	0.91
863-42NR	333	1	6	Yes	302953	3.117	863-FA	336	1	12	Yes	355775	0.91
863-42SQ	333	1	1	Yes	308597	4.5456	863-FA	337	1	12	Yes	355775	0.91
863-42SR	333	1	6	Yes	308474	3.2167	863-FA	339	1	12	Yes	355775	0.91
863-435CQ	415	1	2	Yes	312211	3.8717	863-FA	341	1	12	Yes	355775	0.91
863-435CR	415	1	6	Yes	312204	3.1083	863-FA	346	1	12	Yes	355775	0.91
863-435NQ	334	1	2	Yes	351166	4.7833	863-FA	348	1	12	Yes	355775	0.91
863-435NQ	414	1	2	Yes	351166	4.7833	863-FA	349	1	12	Yes	355775	0.91
863-435NR	334	1	6	Yes	302984	3.0517	863-FACQ	237	1	12	Yes	726674	-
863-435NR	414	1	6	Yes	302984	3.0517	863-FACQ	238	1	12	Yes	726674	-
863-435RBO	415	1	2	Yes	309426	3.2847	863-FACQ	239	1	12	Yes	726674	-
863-435RBR	415	1	6	Yes	302977	3.2847	863-FACQ	240	1	12	Yes	726674	-
863-435SQ	334	1	2	Yes	308634	3.8717	863-FACQ	241	1	12	Yes	726674	-
863-435SQ	415	1	2	Yes	308634	3.8717	863-FACQ	243	1	12	Yes	726674	-
863-435SR	334	1	6	Yes	308481	3.1083	863-FACQ	244	1	12	Yes	726674	-
863-435SR	415	1	6	Yes	308481	3.1083	863-FACQ	245	1	12	Yes	726674	-
863-43NQ	333	1	2	Yes	304810	4.36	863-FACQ	246	1	12	Yes	726674	-
863-43NR	333	1	6	Yes	304803	4.2207	863-FACQ	248	1	12	Yes	726674	-
863-43SQ	333	1	1	Yes	308641	4.55	863-FACQ	250	1	12	Yes	726674	-
863-43SR	333	1	1	Yes	308498	3.3	863-FACQ	253	1	12	Yes	726674	-
863-445NQ	334	1	1	Yes	355577	4.7733	863-FACQ	254	1	12	Yes	726674	-
863-445NR	334	1	6	Yes	303042	3.9727	863-FACQ	261	1	12	Yes	726674	-
863-44NQ	333	1	2	Yes	355614	5.3213	863-FACQ	265	1	12	Yes	726674	-
863-44NR	333	1	6	Yes	304780	3.275	863-FACQ	266	1	12	Yes	726674	-
863-44SQ	333	1	1	Yes	308658	4.5961	863-FACQ	267	1	12	Yes	726674	-
863-44SR	333	1	1	Yes	308528	3.3417	863-FACQ	268	1	12	Yes	726674	-
863-62NQ	336	1	1	Yes	355669	9.7844	863-FACQ	269	1	12	Yes	726674	-
863-62NR	336	1	3	Yes	355676	8.7844	863-FACQ	270	1	12	Yes	726674	-
863-62SQ	336	1	1	Yes	308382	8.9455	863-FN	318	1	12	Yes	351128	1.9417
863-62SR	336	1	1	Yes	308399	8.7065	863-FN	319	1	12	Yes	351128	1.9417
863-63NQ	336	1	1	Yes	355713	11.2314	863-FN	321	1	12	Yes	351128	1.9417
863-63NR	336	1	2	Yes	351210	10.2314	863-FN	322	1	12	Yes	351128	1.9417
863-63SQ	336	1	1	Yes	308429	10.5155	863-FN	326	1	12	Yes	351128	1.9417
863-63SR	336	1	1	Yes	308436	10.2765	863-FN	327	1	12	Yes	351128	1.9417
863-64NQ	336	1	1	Yes	355751	11.4444	863-FN	329	1	12	Yes	351128	1.9417
863-64NR	336	1	2	Yes	355768	10.3351	863-FN	330	1	12	Yes	351128	1.9417
863-64SQ	336	1	1	Yes	308443	10.7285	863-FN	331	1	12	Yes	351128	1.9417
863-64SR	336	1	1	Yes	308450	10.4895	863-FN	332	1	12	Yes	351128	1.9417

Supply

Drainage

Support

Specialties

Appendix

# Numerical Index

Supply

Drainage

Support

Specialties

Appendix

Item No	Page No	Min Qty	Case Qty	UPC Bar-Coded	UPC 6-Digit	Weight (lbs.)	Item No	Page No	Min Qty	Case Qty	UPC Bar-Coded	UPC 6-Digit	Weight (lbs.)
863-FN	333	1	12	Yes	351128	1.9417	863-FNOCQ	238	1	12	Yes	726698	-
863-FN	334	1	12	Yes	351128	1.9417	863-FNOCQ	239	1	12	Yes	726698	-
863-FN	335	1	12	Yes	351128	1.9417	863-FNOCQ	240	1	12	Yes	726698	-
863-FN	336	1	12	Yes	351128	1.9417	863-FNOCQ	241	1	12	Yes	726698	-
863-FN	337	1	12	Yes	351128	1.9417	863-FNOCQ	243	1	12	Yes	726698	-
863-FN	339	1	12	Yes	351128	1.9417	863-FNOCQ	244	1	12	Yes	726698	-
863-FN	341	1	12	Yes	351128	1.9417	863-FNOCQ	245	1	12	Yes	726698	-
863-FN	346	1	12	Yes	351128	1.9417	863-FNOCQ	246	1	12	Yes	726698	-
863-FN	348	1	12	Yes	351128	1.9417	863-FNOCQ	248	1	12	Yes	726698	-
863-FN	349	1	12	Yes	351128	1.9417	863-FNOCQ	250	1	12	Yes	726698	-
863-FNCQ	237	1	12	Yes	726681	-	863-FNOCQ	261	1	12	Yes	726698	-
863-FNCQ	238	1	12	Yes	726681	-	863-FNOCQ	265	1	12	Yes	726698	-
863-FNCQ	239	1	12	Yes	726681	-	863-FNOCQ	266	1	12	Yes	726698	-
863-FNCQ	240	1	12	Yes	726681	-	863-FNOCQ	267	1	12	Yes	726698	-
863-FNCQ	241	1	12	Yes	726681	-	863-FNOCQ	268	1	12	Yes	726698	-
863-FNCQ	243	1	12	Yes	726681	-	863-FNOCQ	269	1	12	Yes	726698	-
863-FNCQ	244	1	12	Yes	726681	-	863-FNOCQ	270	1	12	Yes	726698	-
863-FNCQ	245	1	12	Yes	726681	-	863-HA23	341	1	10	Yes	304476	1.8834
863-FNCQ	246	1	12	Yes	726681	-	863-HA33	341	1	10	Yes	355782	2.0484
863-FNCQ	248	1	12	Yes	726681	-	863-HA44	341	1	10	Yes	355812	2.0534
863-FNCQ	250	1	12	Yes	726681	-	863-HP23	341	1	10	Yes	303295	2.1172
863-FNCQ	253	1	12	Yes	726681	-	863-HP33	341	1	10	Yes	303134	2.2334
863-FNCQ	254	1	12	Yes	726681	-	863-HP34	341	1	10	Yes	351531	2.1734
863-FNCQ	261	1	12	Yes	726681	-	863-HP44	341	1	10	Yes	303158	2.1784
863-FNCQ	265	1	12	Yes	726681	-	863-U	346	1	5	Yes	305572	0.3194
863-FNCQ	266	1	12	Yes	726681	-	863-U	348	1	5	Yes	305572	0.3194
863-FNCQ	267	1	12	Yes	726681	-	864-2A	324	1	3	Yes	351241	2.3617
863-FNCQ	268	1	12	Yes	726681	-	864-2P	324	1	3	Yes	351142	3.075
863-FNCQ	269	1	12	Yes	726681	-	864-3A	324	1	3	Yes	355874	2.525
863-FNCQ	270	1	12	Yes	726681	-	864-3P	324	1	3	Yes	303172	2.6617
863-FNO	318	1	12	Yes	351340	3.4	864-4A	324	1	3	Yes	355881	4.3294
863-FNO	319	1	12	Yes	351340	3.4	864-4P	324	1	3	Yes	303219	2.73
863-FNO	321	1	12	Yes	351340	3.4	864-GP	324	1	1	Yes	355898	1.1584
863-FNO	322	1	12	Yes	351340	3.4	864-S	324	1	10	Yes	303196	0.3245
863-FNO	326	1	12	Yes	351340	3.4	864-UM	324	1	10	Yes	306456	0.6992
863-FNO	327	1	12	Yes	351340	3.4	864-UM	349	1	10	Yes	306456	0.6992
863-FNO	329	1	12	Yes	351340	3.4	864-W2P	349	1	3	Yes	315724	2.9498
863-FNO	330	1	12	Yes	351340	3.4	864-W3P	349	1	3	Yes	315731	3
863-FNO	331	1	12	Yes	351340	3.4	864-W4P	349	1	3	Yes	315748	3.0833
863-FNO	332	1	12	Yes	351340	3.4	864-WGP	349	1	1	Yes	315755	1.2
863-FNO	333	1	12	Yes	351340	3.4	864-WGP2	349	1	1	Yes	321879	1.3868
863-FNO	335	1	12	Yes	351340	3.4	864-WS	349	1	10	Yes	315762	0.4107
863-FNO	336	1	12	Yes	351340	3.4	865-12ECD	388	1	1	No	729514	-
863-FNO	337	1	12	Yes	351340	3.4	865-12OCD	388	1	1	No	729521	-
863-FNO	339	1	12	Yes	351340	3.4	865-12PC	398	1	1	No	724779	-
863-FNO	341	1	12	Yes	351340	3.4	865-16ECD	388	1	1	No	729538	23.35
863-FNO	346	1	12	Yes	351340	3.4	865-16OCD	388	1	1	No	729545	18.4
863-FNO	348	1	12	Yes	351340	3.4	865-4BK	384	1	1	No	734631	3
863-FNO	349	1	12	Yes	351340	3.4	865-4BK	391	1	1	No	734631	3
863-FNOCQ	237	1	12	Yes	726698	-	865-4EC	384	1	1	No	729552	-

Item No	Page No	Min Qty	Case Qty	UPC Bar-Coded	UPC 6-Digit	Weight (lbs.)	Item No	Page No	Min Qty	Case Qty	UPC Bar-Coded	UPC 6-Digit	Weight (lbs.)
865-4EC	391	1	1	No	729552	-	865-FC	380	1	1	Yes	734983	27.4
865-4EC	392	1	1	No	729552	-	865-FCB	380	1	1	Yes	734686	40.12
865-4LPEC3	384	1	1	No	729569	-	865-GGD	379	1	1	Yes	329363	6.825
865-4LPEC3	391	1	1	No	729569	-	865-GGS	379	1	1	Yes	324047	6.1
865-4LPEC3	392	1	1	No	729569	-	865-GGSR	379	1	1	Yes	327932	15.9
865-4LPEC4	384	1	1	No	729576	-	865-GHC	380	1	1	Yes	712288	-
865-4LPEC4	391	1	1	No	729576	-	865-GHS	380	1	2	Yes	324061	3.847
865-4LPEC4	392	1	1	No	729576	-	865-GIC	379	1	1	Yes	324078	18.75
865-4LR	384	1	1	No	729583	-	865-GID	379	1	1	Yes	324085	19.35
865-4LR	391	1	1	No	729583	-	865-GIS	379	1	1	Yes	324092	19.25
865-4OC	384	1	1	No	729590	-	865-GSA	379	1	1	Yes	715463	-
865-4OC	391	1	1	No	729590	-	865-GSB	379	1	2	Yes	725035	-
865-4OC	392	1	1	No	729590	-	865-GSD	379	1	1	Yes	324108	5.3
865-4PC	384	1	1	No	729606	-	865-GSS	379	1	1	Yes	324115	6.05
865-4PC	391	1	1	No	729606	-	865-GSSR	379	1	1	Yes	327949	16.075
865-4PC	392	1	1	No	729606	-	865-HB12005BFA	398	1	1	No	729712	231.4851
865-4RS	384	1	1	No	729613	-	865-HB1200FA	398	1	1	No	722638	242.5082
865-4RS	391	1	1	No	729613	-	865-HB12ADA005BFA	398	1	1	No	729729	231.4851
865-4RS	392	1	1	No	729613	-	865-HB12ADA005FA	398	1	1	No	722799	68.85
865-6LR	386	1	1	No	729620	42	865-HB12ADA005SFA	398	1	1	No	723413	-
865-6LR	393	1	1	No	729620	42	865-HB12ADA00FA	398	1	1	No	722621	242.5082
865-6PC	386	1	1	No	729637	-	865-HB12EC	398	1	1	No	729736	-
865-6PC	387	1	1	No	729637	-	865-HB120C	398	1	1	No	729743	-
865-6PC	393	1	1	No	729637	-	865-HB12S	398	1	1	No	729750	-
865-6PCE	386	1	1	No	729644	-	865-HB4005BFA	397	1	1	No	729767	37.4785
865-6RS	386	1	1	No	729651	-	865-HB4005HSFA	397	1	1	No	729774	37.4785
865-6RS	387	1	1	No	729651	-	865-HB4005SFA	397	1	1	No	729781	37.4785
865-6RS	393	1	1	No	729651	-	865-HB400FA	397	1	1	No	729798	67.2409
865-6UC	386	1	20	Yes	729668	-	865-HB4CBFA	397	1	1	No	729804	83.7756
865-6UC	393	1	20	Yes	729668	-	865-HB4EC	397	1	1	No	729811	-
865-8LR	387	1	1	No	729675	-	865-HB4INSB	397	1	1	No	729828	-
865-8LR	393	1	1	No	729675	-	865-HB40C	397	1	1	No	729835	-
865-8PC	388	1	1	No	729682	-	865-HB6005BFA	397	1	1	No	729842	68.3432
865-8PC	388	1	1	No	729682	-	865-HB6005HSFA	397	1	1	No	729859	70.5478
865-8PC	393	1	1	No	729682	-	865-HB600FA	397	1	1	No	729866	110.8924
865-8RS	388	1	1	No	729699	-	865-HB6ADA005BFA	397	1	1	No	729873	68.3432
865-8RS	388	1	1	No	729699	-	865-HB6ADA005FA	397	1	1	No	729880	68.3432
865-8RS	393	1	1	No	729699	-	865-HB6ADA005HSFA	397	1	1	No	729897	70.5478
865-8UC	387	1	20	Yes	729705	-	865-HB6ADA00FA	397	1	1	No	729903	110.8924
865-8UC	393	1	20	Yes	729705	-	865-HB6ADACBFA	397	1	1	No	729910	121.2541
865-A	380	1	20	No	324801	0.155	865-HB6AINS	397	1	1	No	735850	6.4
865-C	380	1	1	No	324818	-	865-HB6AINS	398	1	1	No	735850	6.4
865-CB4	380	1	1	Yes	735027	0.6	865-HB6AINS	398	1	1	No	735850	6.4
865-CB6	380	1	1	Yes	735041	0.55	865-HB6CBFA	397	1	1	No	729927	121.2541
865-D	380	1	1	Yes	327475	0.55	865-HB6EC	397	1	1	No	729934	-
865-EC	380	1	50	Yes	323989	0.46	865-HB6INSB	397	1	1	No	729941	-
865-EG	380	1	1	Yes	325174	1.45	865-HB6INSB	398	1	1	No	729941	-
865-EO	380	1	25	Yes	323996	0.7125	865-HB6INSB	398	1	1	No	729941	-
865-F	380	1	1	Yes	324030	15.325	865-HB60C	397	1	1	No	729958	-
865-FB	380	1	1	Yes	734990	9	865-HB8005BFA	397	1	1	No	729965	97.0033

Supply

Drainage

Support

Specialties

Appendix

# Numerical Index

Supply

Drainage

Support

Specialties

Appendix

Item No	Page No	Min Qty	Case Qty	UPC Bar-Coded	UPC 6-Digit	Weight (lbs.)	Item No	Page No	Min Qty	Case Qty	UPC Bar-Coded	UPC 6-Digit	Weight (lbs.)
865-HB8005SFA	397	1	1	No	729972	99.2079	865-M4DIFH	383	1	1	No	730404	15.6528
865-HB800FA	397	1	1	No	729989	145.7254	865-M4DIFL	383	1	1	No	730411	15.6528
865-HB8ADA005BFA	398	1	1	No	724786	97.0033	865-M4LP00	384	1	1	No	730428	33.0693
865-HB8ADA005SFA	398	1	1	No	729996	99.2079	865-M4LP005	384	1	1	No	730435	16.5346
865-HB8ADA00FA	398	1	1	No	724199	145.7254	865-M4LP00B	384	1	1	No	730442	33.0693
865-HB8ADACBFA	398	1	1	No	724793	136.6864	865-M4N00	384	1	1	No	730459	61.7294
865-HB8CBFA	397	1	1	No	730008	136.6864	865-M4N005	384	1	1	No	730466	31.967
865-HB8EC	398	1	1	No	730015	-	865-M4N00B	384	1	1	No	730473	61.7294
865-HB8OC	398	1	1	No	730022	-	865-M4N10	383	1	1	No	730480	66.1386
865-HL4L	401	1	1	No	727947	48.4	865-M4N105	383	1	1	No	730497	33.0693
865-HL4N005BF	401	1	1	No	730039	15.4323	865-M4N105S	383	1	1	No	730503	30.8647
865-HL4N005K	401	1	1	No	730046	15.4323	865-M4N10B	383	1	1	No	730510	66.1386
865-HL4N00CSF	401	1	1	No	730053	26.4554	865-M4N15	383	1	1	No	730527	78.264
865-HL4N00F	401	1	1	No	730060	26.4554	865-M4N155	383	1	1	No	730534	39.6832
865-HLAC	401	1	1	No	725936	-	865-M4N155S	383	1	1	No	730541	37.4785
865-HLCE	401	1	1	No	730077	-	865-M4N15B	383	1	1	No	730558	78.264
865-HLDC	401	1	1	No	725943	-	865-M4N20	383	1	1	No	730565	91.4917
865-HLEC	401	1	1	No	730084	-	865-M4N205	383	1	1	No	730572	41.8878
865-HLISC	401	1	1	No	730091	-	865-M4N205S	383	1	1	No	730589	39.6832
865-HLP4AB	401	1	1	No	730107	3.3069	865-M4N20B	383	1	1	No	730596	91.4917
865-HLP4C	401	1	1	No	730114	7.9366	865-M4N25	383	1	1	No	730602	109.1066
865-HLP4N00F1M	401	1	1	No	730121	9.9208	865-M4N255	383	1	1	No	730619	51.7865
865-HLP4N00F3M	401	1	1	No	730138	26.4554	865-M4N255S	383	1	1	No	730626	48.5016
865-HLP4T	401	1	1	No	730145	13.0073	865-M4N25B	383	1	1	No	730633	104.6974
865-HLP4X	401	1	1	No	730152	16.7551	865-M4N30	383	1	1	No	730640	114.6402
865-HLPCE	401	1	1	No	730169	-	865-M4N305	383	1	1	No	730657	56.2178
865-HLPEC	401	1	1	No	730176	-	865-M4N305S	383	1	1	No	730664	56.2178
865-HLPED	401	1	1	No	730183	-	865-M4N30B	383	1	1	No	730671	112.3915
865-HLPISC	401	1	1	No	730190	-	865-M4S01	383	1	1	No	730688	67.4614
865-HLPPED	401	1	1	No	724526	-	865-M4S02	383	1	1	No	730695	68.7841
865-M12PCBEA	387	1	1	No	730206	313.056	865-M4S03	383	1	1	No	730701	70.1069
865-M12PCBFA	388	1	1	No	730213	328.4884	865-M4S04	383	1	1	No	730718	71.6502
865-M12PN005EA	387	1	1	No	730220	217.1551	865-M4S05	383	1	1	No	730725	72.7525
865-M12PN005FA	388	1	1	No	730237	227.0759	865-M4S06	383	1	1	No	730732	74.0752
865-M12PN00BEA	387	1	1	No	730244	423.287	865-M4S07	383	1	1	No	730749	75.6185
865-M12PN00BFA	388	1	1	No	730251	438.7194	865-M4S08	383	1	1	No	730756	77.3822
865-M12PN00EA	387	1	1	No	730268	432.7669	865-M4S09	383	1	1	No	730763	78.9254
865-M12PN00FA	388	1	1	No	730275	453.0494	865-M4S10	383	1	1	No	730770	80.4686
865-M16PCBEA	388	1	1	No	730282	374.7854	865-M4S11	383	1	1	No	730787	82.0119
865-M16PCBFA	388	1	1	No	730299	396.8316	865-M4S12	383	1	1	No	730794	83.7756
865-M16PN005EA	388	1	1	No	730305	286.6006	865-M4S13	383	1	1	No	730800	85.3188
865-M16PN005FA	388	1	1	No	730312	297.6237	865-M4S14	383	1	1	No	730817	86.862
865-M16PN00BEA	388	1	1	No	730329	546.7458	865-M4S15	383	1	1	No	730824	88.4053
865-M16PN00BFA	388	1	1	No	730336	568.792	865-M4S16	383	1	1	No	730831	90.169
865-M16PN00EA	388	1	1	No	730343	551.155	865-M4S17	383	1	1	No	730848	91.7122
865-M16PN00FA	388	1	1	No	730350	593.0428	865-M4S18	384	1	1	No	730855	93.4759
865-M4CB	384	1	1	No	730367	94.7987	865-M4S19	384	1	1	No	730862	95.0191
865-M4DICH	383	1	1	No	730374	11.2436	865-M4S20	384	1	1	No	730879	96.1214
865-M4DICT	383	1	1	No	730381	9.2594	865-M4S21	384	1	1	No	730886	97.6647
865-M4DIDL	383	1	1	No	730398	11.464	865-M4S22	384	1	1	No	730893	99.4284

Item No	Page No	Min Qty	Case Qty	UPC Bar-Coded	UPC 6-Digit	Weight (lbs.)	Item No	Page No	Min Qty	Case Qty	UPC Bar-Coded	UPC 6-Digit	Weight (lbs.)
865-M4S23	384	1	1	No	730909	100.9716	865-M6S07DA	385	1	1	No	731449	170.1967
865-M4S24	384	1	1	No	730916	102.7353	865-M6S07FA	386	1	1	No	731456	194.4475
865-M4S25	384	1	1	No	730923	104.2785	865-M6S08DA	385	1	1	No	731463	172.4013
865-M4S26	384	1	1	No	730930	106.0422	865-M6S08FA	386	1	1	No	731487	196.6521
865-M4S27	384	1	1	No	730947	107.5855	865-M6S09DA	385	1	1	No	731494	174.6059
865-M4S28	384	1	1	No	730954	109.3492	865-M6S09FA	386	1	1	No	731517	198.8567
865-M4S29	384	1	1	No	730961	111.1128	865-M6S10DA	385	1	1	No	731524	176.8105
865-M4S30	384	1	1	No	730978	112.8765	865-M6S10FA	386	1	1	No	731548	200.6204
865-M6CBDA	385	1	1	No	730985	145.5049	865-M8CBDA	387	1	1	No	731555	156.528
865-M6CBF1A	386	1	1	No	730992	158.7326	865-M8CBF1A	387	1	1	No	731562	158.7326
865-M6CBFA	385	1	1	No	731005	156.528	865-M8CBFA	387	1	1	No	731579	158.7326
865-M6N005DA	385	1	1	No	731012	77.1617	865-M8N005DA	387	1	1	No	731586	119.0495
865-M6N005F1A	386	1	1	No	731029	98.1056	865-M8N005F1A	387	1	1	No	731593	122.3564
865-M6N005FA	385	1	1	No	731036	89.2871	865-M8N005FA	387	1	1	No	731609	121.2541
865-M6N005SDA	385	1	1	No	731043	74.9571	865-M8N005SDA	387	1	1	No	731616	119.0495
865-M6N005SF1A	386	1	1	No	731050	98.1056	865-M8N005SF1A	387	1	1	No	731623	122.3564
865-M6N005SFA	385	1	1	No	731067	88.1848	865-M8N005SFA	387	1	1	No	731630	121.2541
865-M6N00BDA	385	1	1	No	731074	150.3551	865-M8N00BDA	387	1	1	No	731647	229.2805
865-M6N00BF1A	386	1	1	No	731081	195.1089	865-M8N00BF1A	387	1	1	No	731654	244.7128
865-M6N00DA	385	1	1	No	731104	150.3551	865-M8N00BFA	387	1	1	No	731661	242.5082
865-M6N00F1A	386	1	1	No	731111	195.1089	865-M8N00DA	387	1	1	No	731678	229.2805
865-M6N00FA	385	1	1	No	731128	174.165	865-M8N00F1A	387	1	1	No	731685	244.7128
865-M6N05DA	385	1	1	No	731135	83.7756	865-M8N00FA	387	1	1	No	731692	242.5082
865-M6N05FA	385	1	1	No	731142	97.0033	865-N3	379	1	1	No	324122	17.495
865-M6N05SSDA	385	1	1	No	731159	81.5709	865-N5	379	1	1	No	324139	19.4185
865-M6N05SFA	385	1	1	No	731166	94.7987	865-N7	379	1	1	No	324146	21.271
865-M6N05BDA	385	1	1	No	731173	166.6693	865-N9	379	1	1	No	324153	23.09
865-M6N05BFA	386	1	1	No	731180	193.1247	865-RAKE	401	1	1	No	731722	-
865-M6N05DA	385	1	1	No	731197	166.6693	865-RAKEP	401	1	1	No	731739	-
865-M6N05FA	386	1	1	No	731203	193.1247	865-S1	379	1	1	No	324160	15.865
865-M6N105DA	385	1	1	No	731210	90.3894	865-S15	380	1	100	Yes	710628	0.0595
865-M6N105FA	386	1	1	No	731227	102.5148	865-S2	379	1	1	No	323828	16.61
865-M6N105SSDA	385	1	1	No	731234	88.1848	865-S3	379	1	1	No	324177	17.54
865-M6N105SFA	386	1	1	No	731241	97.0033	865-S4	379	1	1	No	324184	18.875
865-M6N10BDA	385	1	1	No	731258	178.5742	865-S5	379	1	1	No	323781	19.335
865-M6N10BFA	386	1	1	No	731265	202.825	865-S6	379	1	1	No	324191	20.21
865-M6N10DA	385	1	1	No	731272	178.5742	865-S7	379	1	1	No	324207	21.135
865-M6N10FA	386	1	1	No	731289	202.825	865-S8	379	1	1	No	323798	21.88
865-M6S01DA	385	1	1	No	731296	152.1188	865-S9	379	1	1	No	324214	22.715
865-M6S01FA	386	1	1	No	731319	175.4878	865-SHOVEL	384	1	1	No	731746	-
865-M6S02DA	385	1	1	No	731326	155.4257	865-SHOVEL	386	1	1	No	731746	-
865-M6S02FA	386	1	1	No	731333	179.6765	865-SHOVEL	387	1	1	No	731746	-
865-M6S03DA	385	1	1	No	731340	158.7326	865-SHOVEL	388	1	1	No	731746	-
865-M6S03FA	386	1	1	No	731364	184.0858	865-SHOVEL	388	1	1	No	731746	-
865-M6S04DA	385	1	1	No	731371	162.0396	865-SHOVEL	391	1	1	No	731746	-
865-M6S04FA	386	1	1	No	731395	186.2904	865-SHOVEL	393	1	1	No	731746	-
865-M6S05DA	385	1	1	No	731401	165.3465	865-SHOVEL	393	1	1	No	731746	-
865-M6S05FA	386	1	1	No	731418	189.5973	865-ST4CB	391	1	1	No	731753	92.4
865-M6S06DA	385	1	1	No	731425	167.992	865-ST4N10	391	1	1	No	731760	60.28
865-M6S06FA	386	1	1	No	731432	192.2429	865-ST4N105	391	1	1	No	731777	30.8

Supply

Drainage

Support

Specialties

Appendix

# Numerical Index

Supply

Drainage

Support

Specialties

Appendix

Item No	Page No	Min Qty	Case Qty	UPC Bar-Coded	UPC 6-Digit	Weight (lbs.)	Item No	Page No	Min Qty	Case Qty	UPC Bar-Coded	UPC 6-Digit	Weight (lbs.)
865-ST4N105S	391	1	1	No	731784	28.6	865-T4S11	389	1	1	No	732286	76.25
865-ST4N10B	391	1	1	No	731791	60.28	865-T4S12	389	1	1	No	732293	75.85
865-T4CB	390	1	1	No	731807	82.9	865-T4S13	390	1	1	No	732309	77.3
865-T4DI5CL	389	1	1	No	731814	9.46	865-T4S14	390	1	1	No	732316	80.9
865-T4DI5CX	389	1	1	No	731821	7.9	865-T4S15	390	1	1	No	732323	73.85
865-T4GS5AS	389	1	1	No	731838	-	865-T4S16	390	1	1	No	732330	82.05
865-T4GS5CCS	391	1	1	No	731845	7.7	865-T4S17	390	1	1	No	732347	85.45
865-T4GS5CES	391	1	1	No	731852	7.7	865-T4S18	390	1	1	No	732354	84.25
865-T4GS5CM	389	1	1	No	731869	-	865-T4S19	390	1	1	No	732361	83.4
865-T4GS5CP	389	1	1	No	731876	-	865-T4S20	390	1	1	No	732378	89.35
865-T4GS5CS	389	1	1	No	731883	4.75	865-T4S21	390	1	1	No	732385	92.35
865-T4GSA5P	389	1	1	No	731890	-	865-T4S22	390	1	1	No	732392	96.2
865-T4GSAP	389	1	1	No	731906	-	865-T4S23	390	1	1	No	732408	100.25
865-T4GSAS	389	1	1	No	731913	4.55	865-T4S24	390	1	1	No	732415	101.1
865-T4GSCBCCS	391	1	1	No	731920	11	865-T4S25	390	1	1	No	732422	101.35
865-T4GSCBCES	391	1	1	No	731937	11	865-T4S26	390	1	1	No	732439	103.75
865-T4GSCCS	391	1	1	No	731944	15.4	865-T4S27	390	1	1	No	732446	104.4
865-T4GSCES	391	1	1	No	731951	15.4	865-T4S28	390	1	1	No	732453	104.75
865-T4GSCM	389	1	1	No	731968	-	865-T4S29	390	1	1	No	732460	105.9
865-T4GSCP	389	1	1	No	731975	-	865-T4S30	390	1	1	No	732477	107.45
865-T4GSCS	389	1	1	No	731982	-	865-T4SS5CES	391	1	1	No	732484	7.7
865-T4LP003	390	1	1	No	731999	33	865-T4SSCBCCS	391	1	1	No	732514	11
865-T4LP0053	390	1	1	No	732002	16.5	865-T4SSCBCES	391	1	1	No	732521	11
865-T4LP00B03	390	1	1	No	732019	33	865-T4SSCCS	391	1	1	No	732552	15.4
865-T4N00	390	1	1	No	732026	61.6	865-T4SSCES	391	1	1	No	732569	15.4
865-T4N005	390	1	1	No	732033	28.65	865-T6CB	393	1	1	No	732590	-
865-T4N00B	390	1	1	No	732040	61.6	865-T6DI5CL	392	1	1	No	732606	-
865-T4N10	389	1	1	No	732057	74.8	865-T6GS5CM	392	1	1	No	732613	-
865-T4N105	389	1	1	No	732064	37.25	865-T6GSCM	392	1	1	No	732620	-
865-T4N105S	389	1	1	No	732071	30.8	865-T6N00	392	1	1	No	732637	-
865-T4N10B	389	1	1	No	732088	66	865-T6N005	392	1	1	No	732644	-
865-T4N15	389	1	1	No	732095	78.35	865-T6N005S	392	1	1	No	732651	-
865-T4N155	389	1	1	No	732101	40.3	865-T6N00B	392	1	1	No	732668	-
865-T4N155S	389	1	1	No	732118	37.4	865-T6N05	392	1	1	No	732675	-
865-T4N15B	389	1	1	No	732125	78.1	865-T6N055	392	1	1	No	732682	-
865-T4N20	389	1	1	No	732132	88.45	865-T6N055S	392	1	1	No	732699	-
865-T4N205	389	1	1	No	732149	42.55	865-T6N05B	392	1	1	No	732705	-
865-T4N205S	389	1	1	No	732156	39.6	865-T6N10	392	1	1	No	732712	-
865-T4N20B	389	1	1	No	732163	85.45	865-T6N105	392	1	1	No	732729	-
865-T4P5BL	389	1	1	No	732170	-	865-T6N105S	392	1	1	No	732736	-
865-T4S01	389	1	1	No	732187	61.45	865-T6N10B	392	1	1	No	732743	-
865-T4S02	389	1	1	No	732194	64.05	865-T6S01	392	1	1	No	732750	-
865-T4S03	389	1	1	No	732200	63.4	865-T6S02	392	1	1	No	732767	-
865-T4S04	389	1	1	No	732217	63.35	865-T6S03	392	1	1	No	732774	-
865-T4S05	389	1	1	No	732224	64.8	865-T6S04	392	1	1	No	732781	-
865-T4S06	389	1	1	No	732231	67.65	865-T6S05	392	1	1	No	732798	-
865-T4S07	389	1	1	No	732248	68.75	865-T6S06	392	1	1	No	732804	-
865-T4S08	389	1	1	No	732255	68.9	865-T6S07	392	1	1	No	732811	-
865-T4S09	389	1	1	No	732262	70.75	865-T6S08	392	1	1	No	732828	-
865-T4S10	389	1	1	No	732279	73.05	865-T6S09	392	1	1	No	732835	-



Item No	Page No	Min Qty	Case Qty	UPC Bar-Coded	UPC 6-Digit	Weight (lbs.)	Item No	Page No	Min Qty	Case Qty	UPC Bar-Coded	UPC 6-Digit	Weight (lbs.)
865-T6S10	393	1	1	No	732842	-	867-P3M	354	2	2	Yes	303332	7.294
865-T8CB	393	1	1	No	732859	-	867-P4	354	2	2	Yes	339041	3.3572
865-T8DI5CL	393	1	1	No	732866	-	867-P4M	354	2	2	Yes	305244	7.364
865-T8GS5CM	393	1	1	No	732873	-	867-UM	354	1	1	Yes	375865	0.73
865-T8GSCM	393	1	1	No	732880	-	867-UM	356	1	1	Yes	375865	0.73
865-T8N00	393	1	1	No	732897	-	868-123	277	1	1	No	719645	24.319
865-T8N005	393	1	1	No	732903	-	868-124	277	1	1	No	719652	24.466
865-T8N005S	393	1	1	No	732910	-	868-1503	275	1	1	Yes	376763	32.5623
865-T8N00B	393	1	1	No	732927	-	868-1504	275	1	1	Yes	376534	33
865-TOOL	384	1	1	No	732934	-	868-1506	275	1	1	Yes	375919	32.0552
865-TOOL	386	1	1	No	732934	-	868-15AD	275	1	1	Yes	709332	2.45
865-TOOL	387	1	1	No	732934	-	868-15AD	280	1	1	Yes	709332	2.45
865-TOOL	391	1	1	No	732934	-	868-15CD	275	1	1	Yes	375391	6.79
865-TOOL	393	1	1	No	732934	-	868-15CD	280	1	1	Yes	375391	6.79
865-TOOL	393	1	1	No	732934	-	868-15EXT	275	1	1	Yes	375322	26.55
865-TOOLP	391	1	1	No	723550	-	868-15EXT	280	1	1	Yes	375322	26.55
866-2I	429	1	4	Yes	301055	5.375	868-15S	275	1	1	Yes	375872	8.333
866-2PPK	429	5	5	Yes	301062	0.66	868-15S2	280	1	1	Yes	310002	27
866-2S	432	1	20	Yes	356369	0.2248	868-15SH	275	1	10	Yes	311139	1.1192
866-34PPK	429	5	5	Yes	301093	2.14	868-15SH	280	1	10	Yes	311139	1.1192
866-3I	429	1	4	Yes	301086	11.1125	868-15U	275	1	5	Yes	375902	8.42
866-3S	432	1	20	Yes	301192	0.69	868-15U	280	1	5	Yes	375902	8.42
866-S2I	432	1	10	Yes	301154	1.26	868-15WD	275	1	5	Yes	375384	12.2
866-S3I	432	1	10	Yes	301185	2.24	868-2010	278	1	1	Yes	375308	79.35
867-30PK	457	25	25	Yes	315304	0.2641	868-2012	278	1	1	Yes	375292	83.505
867-35PK	457	25	25	Yes	315359	0.24	868-20CD	279	1	1	Yes	375278	18.6495
867-A2	354	2	2	Yes	351289	2.8422	868-20S	279	1	1	Yes	375155	26.25
867-A2M	354	2	2	Yes	355904	6.849	868-20SH	279	1	1	Yes	322647	2.4916
867-A3	354	2	2	Yes	303264	2.9422	868-20U	279	1	1	Yes	375193	18.54
867-A3M	354	2	2	Yes	355911	6.949	868-20WD	279	1	1	Yes	375216	21.812
867-A4	354	2	2	Yes	351296	2.9922	868-523	275	1	1	No	719218	32.25
867-A4M	354	2	2	Yes	355928	6.999	868-523A	276	1	1	No	726025	28.91
867-C	354	1	25	Yes	339188	1.514	868-523B	276	1	1	No	719263	27.46
867-C	356	1	25	Yes	339188	1.514	868-524	275	1	1	No	719225	30.95
867-DI2	355	1	1	Yes	204905	36.48	868-524A	276	1	1	No	726049	-
867-DI3	355	1	1	Yes	204912	36.1	868-524B	276	1	1	No	719270	26.05
867-DI4	355	1	1	Yes	204929	37.245	868-526	275	1	1	No	719232	31.65
867-HC	354	1	5	Yes	355935	0.6542	868-526A	276	1	1	No	726063	-
867-HC	356	1	5	Yes	355935	0.6542	868-526B	276	1	1	No	719287	26.15
867-HD	354	1	5	Yes	351302	0.5883	868-528	275	1	1	No	719249	31.101
867-L3AP	356	1	1	Yes	374554	6.405	868-528A	276	1	1	No	726087	-
867-L3PP	356	1	1	Yes	374585	7.05	868-528B	276	1	1	No	719294	26.311
867-L4AP	356	1	1	Yes	374516	8.5416	868-5A	441	10	10	Yes	303356	0.4876
867-L4PP	356	1	1	Yes	374509	7	868-5AD	276	1	1	No	734426	2.45
867-MC	354	1	1	Yes	355942	3.6992	868-5CD	276	1	1	Yes	734877	6.79
867-MC	356	1	1	Yes	355942	3.6992	868-5EXT	276	1	1	Yes	734891	26.55
867-MD	354	1	5	Yes	351319	4.6261	868-5P	441	10	10	Yes	303509	0.5476
867-P2	354	2	2	Yes	303301	3.0352	868-5PD	276	1	1	Yes	734884	0.75
867-P2M	354	2	2	Yes	355959	7.179	868-5S	276	1	1	Yes	734921	8.33
867-P3	354	2	2	Yes	339034	3.2872	868-5SH	276	1	1	Yes	734938	1.25

Supply

Drainage

Support

Specialties

Appendix

# Numerical Index

Supply

Drainage

Support

Specialties

Appendix

Item No	Page No	Min Qty	Case Qty	UPC Bar-Coded	UPC 6-Digit	Weight (lbs.)	Item No	Page No	Min Qty	Case Qty	UPC Bar-Coded	UPC 6-Digit	Weight (lbs.)
868-5U	276	1	1	Yes	734945	8.42	868-I4M	277	1	2	Yes	350947	12.9451
868-5WD	276	1	1	Yes	734952	12.2	868-I6	277	1	2	Yes	350954	12.0475
868-7A	441	10	10	Yes	376671	0.3861	868-I6M	277	1	1	Yes	356024	13.7473
868-7P	441	10	10	Yes	376657	0.4272	868-M123	278	1	1	No	719706	31.269
868-823	278	1	1	No	719737	9.645	868-M124	278	1	1	No	719713	31.416
868-824	278	1	1	No	719744	9.773	868-MC	353	1	10	Yes	356031	1.6004
868-9A	441	10	10	Yes	303370	0.5026	868-MCCQ	277	1	10	Yes	726728	-
868-9P	441	10	10	Yes	305145	0.5846	868-MD	353	1	5	Yes	350961	1.9009
868-A3	353	1	2	Yes	355966	4.7475	868-MDCQ	277	1	1	Yes	726735	-
868-A3M	353	1	2	Yes	355973	5.9451	868-N3F	284	1	1	Yes	327956	4.0968
868-A4	353	1	2	Yes	355980	5.2475	868-N3H	284	1	1	Yes	329486	3.75
868-A4M	353	1	2	Yes	355997	6.4451	868-N3S	284	1	1	Yes	724588	3.35
868-A6	353	1	2	Yes	303394	5.4975	868-N4F	284	1	1	Yes	327963	5.25
868-A6M	353	1	2	Yes	356000	6.6951	868-N4H	284	1	1	Yes	327970	4.85
868-C	353	1	5	Yes	303400	2.0679	868-N4S	284	1	1	Yes	724595	4.05
868-CCQ	277	1	5	Yes	726704	-	868-N6F	284	1	1	Yes	327987	7.366
868-D1503	280	1	1	Yes	311252	106.5804	868-N6H	284	1	1	Yes	327994	6.9
868-D1504	280	1	1	Yes	311269	110.1804	868-N6S	284	1	1	Yes	724601	6
868-D1506	280	1	1	Yes	311276	108.1804	868-N8F	284	1	1	Yes	328007	10.4804
868-D523	280	1	1	No	719416	65.478	868-N8H	284	1	1	Yes	328014	11
868-D523A	281	1	1	No	726117	-	868-N8S	284	1	1	Yes	724618	7.9
868-D523B	281	1	1	No	719461	56.9	868-NS3	284	1	1	Yes	328021	0.09
868-D524	280	1	1	No	719423	-	868-NS4	284	1	1	Yes	328038	0.2846
868-D524A	281	1	1	No	726124	-	868-NS6	284	1	1	Yes	328045	0.16
868-D524B	281	1	1	No	719478	-	868-NS8	284	1	1	Yes	328052	0.4296
868-D526	280	1	1	No	719430	-	868-P3	353	1	2	Yes	305183	5.0475
868-D526A	281	1	1	No	726131	-	868-P3M	353	1	2	Yes	350978	6.2451
868-D526B	281	1	1	No	719485	-	868-P4	353	1	2	Yes	303431	4.31
868-D528	280	1	1	No	719447	64.274	868-P4M	353	1	2	Yes	350985	6.4451
868-D528A	281	1	1	No	726148	-	868-P6	353	1	2	Yes	305190	4.4575
868-D528B	281	1	1	No	719492	-	868-P6M	353	1	2	Yes	350992	5.8529
868-D823	281	1	1	No	723987	20.74	868-Q623I	282	1	1	No	724007	67.35
868-D824	281	1	1	No	723994	24.65	868-Q623IN	282	1	1	No	724083	-
868-E	353	1	5	Yes	303417	1.751	868-Q624I	282	1	1	No	724014	65.4
868-ECQ	277	1	5	Yes	726711	-	868-Q624IN	282	1	1	No	726865	78.74
868-F123	278	1	1	No	719676	-	868-Q626I	282	1	1	No	724021	65.685
868-F124	278	1	1	No	719683	32.166	868-Q626IN	282	1	1	No	724090	80.955
868-F523	276	1	1	No	719515	-	868-Q628I	282	1	1	No	724038	66.201
868-F523A	276	1	1	No	726162	-	868-Q628IN	282	1	1	No	724106	79.541
868-F523B	276	1	1	No	719553	-	868-R623I	282	1	1	No	724113	50.4
868-F524	276	1	1	No	719522	-	868-R623IN	282	1	1	No	724120	60.49
868-F524A	276	1	1	No	726179	-	868-R624I	282	1	1	No	724137	50.21
868-F524B	276	1	1	No	719560	53.679	868-R624IN	282	1	1	No	724144	58.54
868-F526	276	1	1	No	719539	-	868-R626I	282	1	1	No	724151	48.735
868-F526A	276	1	1	No	726186	-	868-R626IN	282	1	1	No	724168	58.825
868-F526B	276	1	1	No	719577	-	868-R628I	282	1	1	No	724175	49.251
868-HD	353	1	5	Yes	351043	0.514	868-R628IN	282	1	1	No	724182	59.341
868-I3	277	1	2	Yes	351258	11.0975	868-S	353	1	10	Yes	305091	1.8
868-I3M	277	1	1	Yes	356017	12.2951	868-S3A	283	1	1	Yes	714046	17.7
868-I4	277	1	2	Yes	351234	11.7475	868-S3F	283	1	1	Yes	714053	17.4

Item No	Page No	Min Qty	Case Qty	UPC Bar-Coded	UPC 6-Digit	Weight (lbs.)	Item No	Page No	Min Qty	Case Qty	UPC Bar-Coded	UPC 6-Digit	Weight (lbs.)
868-S4A	283	1	1	Yes	714060	14.55	870-8PK1	367	5	5	Yes	703040	0.65
868-S4F	283	1	1	Yes	714077	14.75	870-93	300	10	10	Yes	303899	0.125
868-S6A	283	1	1	Yes	714084	35.8	870-94	300	10	10	Yes	303905	0.4111
868-S6F	283	1	1	Yes	714091	-	870-95	300	10	10	Yes	303912	0.33
868-SCQ	277	1	10	Yes	726742	-	870-96	300	10	10	Yes	303929	0.5743
868-V234	284	1	1	Yes	713452	6.85	870-98	300	10	10	Yes	303936	0.825
868-WD	353	1	1	Yes	310521	3.9418	870-B	367	25	100	No	303943	0.0846
868-WDCQ	277	1	1	Yes	726759	-	870-B3	367	1	10	Yes	303950	0.3377
869-23	448	1	1	Yes	303479	2.35	870-B4	367	1	10	Yes	303967	0.4173
869-2A	448	1	8	Yes	305084	0.634	870-B5	367	1	10	Yes	303974	0.6242
869-2P	448	1	8	Yes	306005	0.8126	870-B6	367	1	10	Yes	303981	0.4093
869-2PS	448	1	1	Yes	713995	3.8	870-B8	367	1	10	Yes	303998	0.62
869-60	448	1	10	Yes	303721	0.04	871-16	366	25	25	Yes	304001	0.157
869-61	448	1	10	Yes	303738	0.63	871-18	366	10	10	Yes	304018	0.35
869-6P	448	1	1	No	306203	9.8	871-4	366	25	25	Yes	313041	0.0716
869-6P1	448	1	2	Yes	303783	2.3025	871-6	366	25	25	Yes	313065	0.1392
869-S3A	447	4	4	Yes	313638	2.1134	871-8	366	1	10	Yes	313089	0.2798
869-S3APK	447	2	2	Yes	313645	2.4649	872-16	366	25	25	Yes	304056	0.2326
869-S3AS	447	1	1	Yes	313652	9.6	872-18	366	10	10	Yes	304032	0.27
869-S3P	447	4	4	Yes	313669	2.6088	872-4	366	25	25	Yes	356413	0.0902
869-S3PPK	447	2	2	Yes	313676	3.0029	872-6	366	25	25	Yes	313362	0.198
869-S3PS	447	1	1	Yes	313683	10.135	872-8	366	10	10	Yes	313386	0.2624
869-S4A	447	4	4	Yes	313690	1.691	873-10	300	1	1	No	727282	-
869-S4ADB	447	1	1	Yes	313706	2.369	873-240	367	1	10	Yes	306715	0.453
869-S4APK	447	2	2	Yes	313713	3.0925	873-240P	367	1	10	Yes	369666	0.2271
869-S4AS	447	1	1	Yes	313720	10.65	873-256	300	1	1	Yes	718433	-
869-S4P	447	4	4	Yes	313737	3.3825	873-26	300	1	1	Yes	718426	-
869-S4PDB	447	1	1	Yes	313744	2.9249	873-350	367	1	10	Yes	304117	0.7688
869-S4PPK	447	2	2	Yes	313751	3.73	873-350P	367	1	10	Yes	369765	0.5981
869-S4PS	447	1	1	Yes	313768	11.245	873-356	300	1	1	Yes	718457	-
869-SF3	447	10	10	Yes	313775	0.3235	873-36	300	1	1	Yes	718440	-
869-SF4	447	10	10	Yes	313782	0.4367	873-460	367	1	10	Yes	304285	0.885
869-SSK	447	1	1	Yes	313805	2.066	873-460P	367	1	10	Yes	369772	0.7561
869-SSL	447	4	4	Yes	313812	1.2227	873-48	300	1	1	Yes	718464	2.15
869-SV4	433	10	10	Yes	344045	2.0452	873-6	300	1	1	Yes	727275	-
869-SVLB	447	10	10	Yes	313829	0.4411	873-610	300	1	1	Yes	718471	4.05
869-SVLW	447	10	10	Yes	313836	0.4279	873-8	300	1	1	Yes	727268	-
869-V34	457	4	4	Yes	302076	0.6352	873-810	300	1	1	Yes	718488	6.5
869-V4	431	1	4	Yes	344021	9.2468	874-1	368	25	1000	No	304421	0.0173
870-2CM	367	25	25	Yes	303813	0.0574	874-1C	368	25	1000	No	304278	0.0203
870-3	366	25	25	Yes	305237	0.068	874-1W	368	25	100	No	306791	0.0227
870-3PK1	367	5	5	Yes	312136	0.1	874-2	368	25	1000	No	304261	0.0274
870-4	366	25	25	Yes	306708	0.1168	874-2N	368	50	200	No	722317	-
870-4PK1	367	5	5	Yes	312143	0.15	874-3C	368	25	500	No	304179	0.033
870-5	366	25	25	Yes	304094	0.17	874-3W	368	25	1000	No	304254	0.0206
870-6	366	25	25	Yes	303851	0.2449	874-4	368	25	500	No	304193	0.0457
870-6PK1	367	5	5	Yes	312167	0.3	874-4C	368	25	500	No	304209	0.0538
870-8	366	10	10	Yes	303868	0.6369	874-4W	368	25	100	No	304216	0.0554
870-810	366	5	5	Yes	303875	0.765	874-6	368	25	1000	No	304223	0.0681
870-812	366	5	5	Yes	303882	1.115	874-6C	368	25	100	No	304230	0.0706

Supply

Drainage

Support

Specialties

Appendix

# Numerical Index

Supply

Drainage

Support

Specialties

Appendix

Item No	Page No	Min Qty	Case Qty	UPC Bar-Coded	UPC 6-Digit	Weight (lbs.)	Item No	Page No	Min Qty	Case Qty	UPC Bar-Coded	UPC 6-Digit	Weight (lbs.)
874-6W	368	<b>25</b>	100	No	351012	0.0709	<b>878-040PK</b>	370	25	25	Yes	307606	0.1703
875-2A	369	20	20	Yes	314048	0.093	<b>878-15</b>	370	<b>25</b>	25	No	304537	0.0471
875-2P	369	20	20	Yes	314024	0.1107	<b>878-15PK</b>	370	25	25	Yes	307118	0.0485
875-3A	369	20	20	Yes	314086	0.1719	<b>878-20</b>	370	<b>25</b>	25	No	304544	0.0648
875-3P	369	20	20	Yes	314062	0.1903	<b>878-20PK</b>	370	25	25	Yes	307217	0.065
875-4A	369	20	20	Yes	314123	0.2196	<b>878-25</b>	370	<b>25</b>	25	No	304551	0.0857
875-4P	369	20	20	Yes	265913	0.2422	<b>878-30</b>	370	<b>25</b>	25	No	304568	0.1138
875-8230P	369	1	10	Yes	304308	0.3192	<b>878-30PK</b>	370	25	25	Yes	307415	0.123
875-8340P	369	1	10	Yes	304315	0.6519	<b>878-35</b>	370	<b>25</b>	25	No	304575	0.1396
875-83AN	369	1	12	Yes	727022	-	<b>878-35PK</b>	370	25	25	Yes	307514	0.1485
875-83PN	369	1	12	Yes	727046	0.775	<b>878-40</b>	370	<b>25</b>	25	No	304582	0.1708
875-8450P	369	1	10	Yes	304322	0.9435	<b>878-40PK</b>	370	25	25	Yes	307613	0.176
875-84AN	369	<b>1</b>	12	Yes	724366	0.8792	<b>878-50</b>	370	25	25	No	304599	0.7116
875-84PN	369	1	12	Yes	708380	1.1542	<b>878-60</b>	370	8	8	No	304605	0.4101
876-CS15	301	10	10	Yes	718594	0.165	<b>878-915</b>	371	10	20	No	356147	0.795
876-CS20	301	10	10	Yes	718600	0.2112	<b>878-920</b>	371	10	10	No	351050	0.1372
876-CS25	301	10	10	Yes	718617	0.3124	<b>878-930</b>	371	10	10	No	304636	0.288
876-CS30	301	10	10	Yes	718624	0.3322	<b>878-935</b>	371	10	20	No	356161	0.9201
876-CS35	301	10	10	Yes	718631	0.4466	<b>878-940</b>	371	10	10	No	304643	0.474
876-CS40	301	10	10	Yes	718648	0.5126	<b>878-950</b>	371	10	10	No	351067	1.0247
876-CS60	301	10	10	Yes	718655	1.1396	<b>878-960</b>	371	10	10	No	304650	1.1586
876-CS80	301	10	10	Yes	718662	2.387	<b>878-980</b>	371	10	10	No	351074	2.343
876-RS15	301	10	10	Yes	718501	0.102	<b>878-S15</b>	371	<b>25</b>	25	No	329134	0.046
876-RS20	301	10	10	Yes	718518	0.145	<b>878-S20</b>	371	<b>25</b>	25	No	329158	0.058
876-RS25	301	10	10	Yes	718525	0.221	<b>878-S30</b>	371	<b>25</b>	25	No	329141	0.13
876-RS30	301	10	10	Yes	718532	0.301	<b>878-S40</b>	371	<b>25</b>	25	No	329165	0.01
876-RS35	301	10	10	Yes	718549	0.368	<b>879-015</b>	370	<b>25</b>	25	No	304667	0.0414
876-RS40	301	10	10	Yes	718556	0.4862	<b>879-015PK</b>	370	25	25	Yes	308108	0.0428
876-RS50	301	10	10	Yes	728555	0.696	<b>879-020</b>	370	<b>25</b>	25	No	304674	0.0585
876-RS60	301	10	10	Yes	718563	1.0274	<b>879-020PK</b>	370	25	25	Yes	308207	0.0599
876-RS80	301	10	10	Yes	718570	2.299	<b>879-025</b>	370	<b>25</b>	25	No	356178	0.0689
876-SL15	301	10	10	Yes	718686	0.246	<b>879-025PK</b>	370	25	25	Yes	308306	0.082
876-SL20	301	10	10	Yes	718693	0.331	<b>879-030</b>	370	<b>25</b>	25	No	304681	0.0898
876-SL25	301	10	10	Yes	718709	0.411	<b>879-030PK</b>	370	25	25	Yes	308405	0.1162
876-SL30	301	10	10	Yes	718716	0.798	<b>879-035</b>	370	<b>25</b>	25	No	356185	0.1391
876-SL35	301	10	10	Yes	718723	1.08	<b>879-035PK</b>	370	25	25	Yes	308504	0.146
876-SL40	301	10	10	Yes	718730	1.391	<b>879-040</b>	370	<b>25</b>	25	No	304698	0.1651
876-SL60	301	10	10	Yes	718747	2.824	<b>879-040PK</b>	370	25	25	Yes	308603	0.1683
876-SL80	301	10	10	Yes	718754	5.089	<b>879-15</b>	370	<b>25</b>	25	No	304704	0.0481
878-015	370	<b>25</b>	25	No	304483	0.0414	<b>879-15PK</b>	370	25	25	Yes	308115	0.0495
878-015PK	370	25	25	Yes	307101	0.055	<b>879-20</b>	370	<b>25</b>	25	No	304711	0.0636
878-020	370	<b>25</b>	25	No	304490	0.0585	<b>879-20PK</b>	370	25	25	Yes	308214	0.065
878-020PK	370	25	25	No	307200	0.0599	<b>879-25</b>	370	<b>25</b>	25	No	356192	0.0857
878-025	370	<b>25</b>	25	No	350930	0.0689	<b>879-30</b>	370	<b>25</b>	25	No	304728	0.1138
878-025PK	370	25	25	Yes	307309	0.084	<b>879-30PK</b>	370	25	25	Yes	308412	0.123
878-030	370	<b>25</b>	25	No	304506	0.1054	<b>879-35</b>	370	<b>25</b>	25	No	304735	0.137
878-030PK	370	25	25	Yes	307408	0.1158	<b>879-35PK</b>	370	25	25	Yes	308511	0.1459
878-035	370	<b>25</b>	25	No	304513	0.1391	<b>879-40</b>	370	<b>25</b>	25	No	304742	0.1732
878-035PK	370	25	25	Yes	307507	0.148	<b>879-40PK</b>	370	25	25	Yes	308610	0.1764
878-040	370	<b>25</b>	25	No	304520	0.1651	<b>879-50</b>	370	20	20	No	304759	0.2944

Item No	Page No	Min Qty	Case Qty	UPC Bar-Coded	UPC 6-Digit	Weight (lbs.)	Item No	Page No	Min Qty	Case Qty	UPC Bar-Coded	UPC 6-Digit	Weight (lbs.)
879-60	370	8	8	No	304766	0.7777	881-14C	465	<b>10</b>	50	No	305077	0.0637
879-S15	371	<b>25</b>	25	No	329127	0.046	881-2	466	<b>100</b>	1000	No	302427	0.0133
879-S20	371	<b>25</b>	25	No	329110	0.056	881-3	466	<b>50</b>	500	No	356406	0.0266
879-S30	371	<b>25</b>	25	No	329103	0.134	881-4	466	<b>50</b>	500	No	302441	0.0546
879-S40	371	<b>25</b>	25	No	329097	0.182	881-510	464	1	1	No	566492	20.9439
880	457	25	25	No	304773	0.5412	881-52	464	1	5	No	566485	0.8172
880-012	466	<b>100</b>	500	No	302816	0.0466	881-53	464	1	5	No	566478	1.8453
880-01A	466	<b>50</b>	500	No	327307	0.0363	881-54	464	1	1	No	566621	3.2555
880-01P	466	<b>50</b>	500	No	327314	0.0471	881-56	464	1	1	No	566591	9.7836
880-02A	466	<b>25</b>	500	No	327321	0.0519	881-58	464	1	1	No	566607	15.3662
880-02P	466	<b>25</b>	500	No	327345	0.0663	882-1	463	10	10	Yes	302212	0.1765
880-034	466	<b>50</b>	250	No	302830	0.1117	882-105	471	1	6	No	507594	0.9333
880-03A	466	<b>20</b>	200	No	327352	0.0844	882-110	471	1	6	No	507600	0.8034
880-03P	466	<b>20</b>	200	No	327369	0.1058	882-115	463	1	25	Yes	308726	0.3298
880-04A	466	<b>25</b>	100	No	327376	0.131	882-1P	463	10	10	No	351081	0.426
880-04P	466	<b>25</b>	100	No	327383	0.169	882-2	463	10	10	Yes	302229	0.2426
880-1	466	25	25	No	302311	0.15	882-2P	463	10	10	No	305176	0.4566
880-2	466	25	25	No	302328	0.238	882-3	463	10	10	Yes	302236	0.38
880-3	466	25	25	No	302335	0.356	882-35	463	10	10	Yes	302298	0.4837
880-4	466	25	25	No	356390	0.378	882-3P	463	10	10	No	305220	0.6353
880-81	465	<b>25</b>	200	No	304841	0.0255	882-4	463	10	10	Yes	302243	0.4837
880-81C	465	<b>25</b>	200	No	304858	0.0253	882-41	463	10	10	Yes	302304	0.6677
880-81PK	465	50	50	Yes	303035	0.0303	882-4P	463	10	10	No	351098	0.8817
880-82	465	<b>25</b>	100	No	304872	0.0393	882-647	467	<b>6</b>	24	Yes	331014	0.085
880-82C	465	<b>25</b>	100	No	304889	0.035	882-647W	467	<b>1</b>	20	No	715470	-
880-82PK	465	50	50	Yes	303073	0.0331	882-95	464	1	30	No	305275	1.066
880-83	465	<b>10</b>	50	No	304902	0.0697	882-96	464	1	30	No	305282	1.2767
880-83C	465	<b>10</b>	50	No	304919	0.0693	882-98	464	1	12	No	305299	2.033
880-83PK	465	25	25	Yes	303080	0.0684	882-CS202	463	10	100	No	357557	0.1144
880-84	465	<b>10</b>	50	No	304933	0.0977	882-CS302	463	10	100	No	357540	0.2241
880-84C	465	<b>10</b>	50	No	304940	0.0984	882-CS402	463	10	100	No	357533	0.4112
880-84PK	465	25	25	Yes	303103	0.0967	882-EB152	463	10	100	No	357526	0.0197
881-01-10	464	1	1	No	566553	5.3837	882-EB220	463	10	100	No	357519	0.079
881-01-2	464	<b>5</b>	5	Yes	566546	0.1508	882-EB320	463	10	100	No	357502	0.3577
881-01-3	464	<b>5</b>	5	Yes	566539	0.2925	882-EB350	463	10	100	No	357496	0.4285
881-01-4	464	<b>5</b>	5	Yes	566522	0.5159	882-EB420	463	10	100	No	357489	0.5394
881-01-6	464	<b>1</b>	5	Yes	566515	0.544	882-EHPG	471	1	1	Yes	305336	4.3388
881-01-8	464	<b>2</b>	2	Yes	566508	2.8605	882-EL23	465	1	1	Yes	305343	2.15
881-02A	465	1	10	No	304964	0.6085	882-EL34	465	1	1	Yes	305350	4.19
881-02A	471	1	10	No	304964	0.6085	882-EL46	465	1	1	Yes	305367	4.28
881-02FP	465	<b>100</b>	1000	No	304971	0.0017	882-ES12	465	1	1	Yes	305374	0.43
881-02H	465	1	25	No	304988	0.4189	882-ES23	465	1	1	Yes	305381	0.55
881-1	466	<b>100</b>	1000	No	302410	0.0084	882-ES34	465	1	1	Yes	305398	0.7
881-10	465	<b>25</b>	200	No	305008	0.0171	882-ES46	465	1	1	Yes	305404	2.8406
881-10C	465	<b>25</b>	200	No	305015	0.0171	882-ST152	463	10	100	No	357472	0.011
881-12	465	<b>25</b>	100	No	305022	0.0256	882-ST202	463	10	100	No	357465	0.1388
881-12C	465	<b>25</b>	100	No	305039	0.0256	882-ST300	463	10	100	No	357458	0.3549
881-13	465	<b>10</b>	50	No	305046	0.0464	882-ST302	463	10	100	No	357441	0.2626
881-13C	465	<b>10</b>	50	No	305053	0.0464	882-ST402	463	10	100	No	357434	0.415
881-14	465	<b>10</b>	50	No	305060	0.0608	882-ST602	463	10	10	No	357427	0.9758

Supply

Drainage

Support

Specialties

Appendix

# Numerical Index

Supply

Drainage

Support

Specialties

Appendix

Item No	Page No	Min Qty	Case Qty	UPC Bar-Coded	UPC 6-Digit	Weight (lbs.)	Item No	Page No	Min Qty	Case Qty	UPC Bar-Coded	UPC 6-Digit	Weight (lbs.)
882-ST802	463	10	10	No	357410	2.0576	886-RQK	442	25	25	Yes	317445	0.5377
882-TT2	464	1	48	Yes	305411	0.45	886-RQK	635	25	25	Yes	317445	0.5377
882-TT3	464	1	18	Yes	305428	1.2024	887-AM	438	25	25	Yes	303165	0.6336
882-TT4	464	1	8	Yes	305435	2.3072	887-GAM	439	6	6	Yes	303844	0.6242
883-AT	437	<b>25</b>	25	Yes	303097	0.6063	887-GPM	439	6	6	Yes	303820	0.4064
883-ATPK	437	8	8	Yes	303097	0.6442	887-GTPMK	439	1	1	Yes	339270	1.736
883-PT	437	25	25	Yes	303059	0.741	887-PM	438	25	25	Yes	303127	0.7295
883-PTPK	437	8	8	Yes	303059	0.8142	888-A	438	<b>20</b>	20	Yes	305633	0.4802
884-ATM	437	<b>24</b>	24	Yes	303189	0.6952	888-AM	438	12	12	Yes	356581	0.8402
884-ATMPK	437	8	8	Yes	303189	0.7256	888-APK	438	10	10	Yes	303363	0.43
884-PTM	437	<b>24</b>	24	Yes	303141	0.8249	888-ATM	437	<b>25</b>	25	Yes	352187	0.5328
884-PTMPK	437	8	8	Yes	303141	0.9662	888-ATMPK	437	8	8	Yes	352187	0.6679
886-411	442	20	20	Yes	303523	0.3306	888-GAM	439	6	6	Yes	378279	0.7017
886-411	635	20	20	Yes	303523	0.3306	888-GPM	439	6	6	Yes	356598	0.91
886-4A	438	<b>25</b>	25	Yes	305510	0.5362	888-P	438	<b>20</b>	20	Yes	365132	0.6077
886-4AM	438	25	25	Yes	356635	0.7249	888-PM	438	12	12	Yes	356574	1.0337
886-4AMSPK	438	6	6	Yes	303691	0.6617	888-PPK	438	10	10	Yes	303325	0.6865
886-4ATM	437	25	25	Yes	352057	0.7216	888-PTM	437	<b>25</b>	25	Yes	352200	0.6222
886-4ATMPK	437	8	8	Yes	352057	0.7216	888-PTMPK	437	8	8	Yes	352200	0.6438
886-4ATMSPK	437	8	8	Yes	352064	0.7056	889-45AM	440	20	20	Yes	352217	0.7822
886-4P	438	<b>25</b>	25	Yes	303608	0.665	889-45AMPK2	440	6	6	Yes	352217	0.8008
886-4PM	438	25	25	Yes	356628	0.7137	889-45PM	440	<b>20</b>	20	Yes	305664	0.9508
886-4PMSPK	438	6	6	Yes	303684	0.7192	889-45PMPK2	440	6	6	Yes	303288	0.9809
886-4PPK	438	6	6	Yes	303745	0.6821	889-AOM	440	<b>20</b>	20	Yes	305671	0.911
886-4PTM	437	25	25	Yes	352095	0.7786	889-AOMPK	440	6	6	Yes	303240	0.9412
886-4PTMPK	437	8	8	Yes	352095	0.805	889-AOTM	440	20	20	Yes	357403	0.8572
886-4PTMSPK	437	8	8	Yes	352101	0.7988	889-GAOM	440	5	5	Yes	309068	0.94
886-A	438	<b>20</b>	20	Yes	303066	0.5152	889-GPOM	440	5	5	Yes	313225	0.948
886-APK	438	10	10	Yes	303066	0.4915	889-POM	440	20	20	Yes	305688	1.0925
886-ATMS	437	<b>25</b>	25	Yes	352132	0.591	889-POMPK	440	6	6	Yes	303226	1.1227
886-ATMSPK	437	8	8	Yes	352132	0.63	889-PTM	440	20	20	Yes	357397	1.1555
886-ER	442	25	25	Yes	303561	0.194	890-4BDPK	441	10	10	Yes	303554	0.8605
886-ER	635	25	25	Yes	303561	0.194	890-4BPK	441	10	10	Yes	303547	0.6585
886-GA	439	5	5	Yes	380944	0.6767	890-I42	441	4	4	Yes	303622	3.425
886-GI	439	<b>5</b>	5	Yes	327499	3.05	891-0312P	457	5	5	Yes	310323	0.7158
886-GP	439	5	5	Yes	380937	0.6593	891-033P	457	5	5	Yes	310330	0.9239
886-MR	442	20	20	Yes	303448	0.3704	891-0412P	457	5	5	Yes	310422	0.8763
886-MR	635	20	20	Yes	303448	0.3704	891-043P	457	5	5	Yes	310439	1.1318
886-MRM	442	8	8	Yes	309105	0.65	891-044P	457	5	5	Yes	310446	1.2128
886-MRM	635	8	8	Yes	309105	0.65	899-306R0009	665	<b>1</b>	1	Yes	444165	11
886-P	438	<b>20</b>	20	Yes	303028	0.6309	899-333N0033	665	<b>1</b>	1	Yes	444097	17.65
886-PPK	438	10	10	Yes	303028	0.6309	900-01021C04005	647	<b>1</b>	1	Yes	444059	4.85
886-PT30	437	25	25	Yes	356611	0.5883	900-01023C01005	647	<b>1</b>	1	Yes	443991	2.7
886-PTM30	437	25	25	Yes	352156	0.6276	900-01030C00101	647	<b>10</b>	10	Yes	443922	0.185
886-PTMS	437	<b>25</b>	25	Yes	352163	0.6868	900-01030C00201	647	<b>10</b>	10	Yes	443892	0.4
886-PTMSPK	437	8	8	Yes	352163	0.6868	900-01030C04005	647	<b>1</b>	1	Yes	443847	6.85
886-R	442	20	20	Yes	303424	0.2722	900-01053C00101	647	<b>10</b>	10	Yes	443755	0.3
886-R	635	20	20	Yes	303424	0.2722	900-01053C00201	647	<b>10</b>	10	Yes	443748	0.57
886-RQ	442	20	20	Yes	378644	0.147	900-01053C03005	647	<b>1</b>	1	Yes	443687	9.55
886-RQ	635	20	20	Yes	378644	0.147	900-01103C00101	647	<b>10</b>	10	Yes	443526	0.4

Item No	Page No	Min Qty	Case Qty	UPC Bar-Coded	UPC 6-Digit	Weight (lbs.)	Item No	Page No	Min Qty	Case Qty	UPC Bar-Coded	UPC 6-Digit	Weight (lbs.)
900-01103C00201	647	<b>10</b>	10	Yes	443496	0.76	900-02609C00021	649	<b>5</b>	5	Yes	206381	1.39
900-01103C00501	647	<b>2</b>	2	Yes	443458	2.125	900-02609C00505	649	<b>1</b>	1	Yes	439727	33.5
900-01103C01005	647	<b>1</b>	1	Yes	443410	4.14	900-04258N00101	626	<b>10</b>	10	Yes	439659	3.055
900-01103C02505	647	<b>1</b>	1	Yes	443373	9.4	900-04258N00101	657	<b>10</b>	10	Yes	439659	3.055
900-01153C00101	647	<b>10</b>	10	Yes	443274	0.6	900-04258N00505	626	<b>1</b>	1	Yes	439635	16.6
900-01153C00201	647	<b>10</b>	10	Yes	443250	0.88	900-04258N00505	657	<b>1</b>	1	Yes	439635	16.6
900-01153C02005	647	<b>1</b>	1	Yes	443175	9.52	900-04338N00021	626	<b>12</b>	12	Yes	439581	0.7917
900-01163C00101	647	<b>10</b>	10	Yes	443021	0.56	900-04338N00021	657	<b>12</b>	12	Yes	439581	0.7917
900-01163C00201	647	<b>10</b>	10	Yes	442994	1.04	900-04338N00101	626	<b>5</b>	5	Yes	439550	0.5
900-01163C00501	647	<b>1</b>	1	Yes	442949	2.775	900-04338N00101	657	<b>5</b>	5	Yes	439550	0.5
900-01163C01005	647	<b>1</b>	1	Yes	442901	6.11	900-04338N00255	626	<b>1</b>	1	Yes	439543	10.65
900-01163N00101	649	<b>5</b>	5	Yes	442819	0.515	900-04338N00255	657	<b>1</b>	1	Yes	439543	10.65
900-01164C01005	647	<b>1</b>	1	Yes	442697	8.85	900-06103Y00101	658	<b>5</b>	5	Yes	439468	0.33
900-01203C00101	647	<b>10</b>	10	Yes	442635	0.745	900-06103Y00505	658	<b>1</b>	1	Yes	439437	2.35
900-01203C00201	647	<b>10</b>	10	Yes	442598	1.42	900-07256G01505	657	<b>1</b>	1	Yes	439345	19.5
900-01203C00501	647	<b>1</b>	1	Yes	442567	3.7	900-12256N00101	626	<b>10</b>	5	Yes	438980	2.22
900-01203C01005	647	<b>1</b>	1	Yes	442512	7.5	900-12256N00101	657	<b>10</b>	5	Yes	438980	2.22
900-01203N00101	649	<b>5</b>	5	Yes	442420	0.95	900-12306N00101	657	<b>10</b>	5	Yes	438928	2.48
900-01206C00101	647	<b>10</b>	10	Yes	442369	1.415	900-14010R00051	661	<b>10</b>	10	Yes	206596	0.12
900-01206C01005	647	<b>1</b>	1	Yes	442253	15	900-14010R01005	661	<b>1</b>	1	Yes	438782	1.85
900-01253C00101	648	<b>10</b>	10	Yes	442208	0.99	900-14018R00051	661	<b>10</b>	10	Yes	206633	0.09
900-01253C00201	648	<b>5</b>	5	Yes	441836	1.64	900-14018R01004	661	<b>1</b>	1	Yes	438775	2.1
900-01253C01005	648	<b>1</b>	1	Yes	441669	7.7	900-14023R00101	661	<b>5</b>	5	Yes	205704	0.2
900-01256C00101	648	<b>5</b>	5	Yes	441553	1.915	900-15106N00051	661	<b>5</b>	5	Yes	438690	0.45
900-01256C01005	648	<b>1</b>	1	Yes	441492	18.16	900-15106N01005	661	<b>1</b>	1	Yes	438652	9.35
900-01306C00101	648	<b>10</b>	10	Yes	441423	2.095	900-15157N00051	661	<b>1</b>	10	Yes	206695	0.5
900-01306C00201	648	<b>5</b>	5	Yes	441393	3.43	900-15166N00051	661	<b>1</b>	10	Yes	206589	0.555
900-01306C00755	648	<b>1</b>	1	Yes	441287	14.6	900-16200W01004	658	<b>1</b>	1	Yes	438591	18.5
900-01306N00101	649	<b>5</b>	5	Yes	441249	2.05	900-16300W00021	658	<b>1</b>	5	Yes	206602	0.44
900-01406C00021	648	<b>5</b>	5	Yes	206077	0.59	900-16300W00101	658	<b>1</b>	1	Yes	438584	2.1
900-01406C00101	648	<b>5</b>	5	Yes	441157	2.84	900-16300W01004	658	<b>1</b>	1	Yes	438577	22.95
900-01406C00505	648	<b>1</b>	1	Yes	441065	14.15	900-16400W00021	658	<b>1</b>	5	Yes	206718	0.59
900-01406C01005	648	<b>1</b>	1	Yes	440921	28.5	900-16400W00101	658	<b>1</b>	1	Yes	438560	3.95
900-01508C00255	648	<b>1</b>	1	Yes	440815	14	900-16400W00504	658	<b>1</b>	1	Yes	438553	17.2
900-01508C00504	648	<b>1</b>	1	Yes	440785	27.75	900-16500W00021	658	<b>1</b>	5	Yes	206879	0.79
900-01608C00505	648	<b>1</b>	1	Yes	440716	31.13	900-16500W00101	658	<b>1</b>	1	Yes	438539	5.35
900-02106C00101	648	<b>10</b>	10	Yes	440662	0.9	900-16500W00504	658	<b>1</b>	1	Yes	438522	26.65
900-02106C02505	648	<b>1</b>	1	Yes	440549	22.55	900-16600W00021	658	<b>1</b>	5	Yes	206886	0.9
900-02166C00101	648	<b>10</b>	10	Yes	440518	1.32	900-16600W00101	658	<b>1</b>	1	Yes	438508	5.75
900-02166C01505	648	<b>1</b>	1	Yes	440396	17.3	900-16600W00504	658	<b>1</b>	1	Yes	438492	24.5
900-02206C00101	648	<b>10</b>	10	Yes	440341	1.425	900-16700W00021	658	<b>1</b>	5	Yes	206909	1.32
900-02206C01005	648	<b>1</b>	1	Yes	440273	15.2	900-16700W00101	658	<b>1</b>	1	Yes	206930	8.95
900-02256C00101	648	<b>10</b>	10	Yes	440228	1.79	900-18300W00061	658	<b>3</b>	3	Yes	438423	0.35
900-02256C00755	648	<b>1</b>	1	Yes	440181	14.05	900-18430W00061	658	<b>3</b>	3	Yes	438393	0.5
900-02306C00101	649	<b>10</b>	10	Yes	440105	2.075	900-19600B00251	658	<b>5</b>	5	Yes	438300	2.04
900-02306C00755	649	<b>1</b>	1	Yes	440020	15.75	900-19600B00501	658	<b>5</b>	5	Yes	438294	4
900-02408C00101	649	<b>5</b>	5	Yes	439918	3.61	900-19700B00251	658	<b>5</b>	5	Yes	438225	2.62
900-02408C00505	649	<b>1</b>	1	Yes	439888	20.05	900-19700B00501	658	<b>5</b>	5	Yes	438195	4.13
900-02509C00021	649	<b>5</b>	5	Yes	206374	1.44	901-03020W00251	618	<b>10</b>	10	Yes	437921	0.325
900-02509C00505	649	<b>1</b>	1	Yes	439796	27.65	901-03020W00251	653	<b>10</b>	10	Yes	437921	0.325

Supply

Drainage

Support

Specialties

Appendix

# Numerical Index

Supply

Drainage

Support

Specialties

Appendix

Item No	Page No	Min Qty	Case Qty	UPC Bar-Coded	UPC 6-Digit	Weight (lbs.)	Item No	Page No	Min Qty	Case Qty	UPC Bar-Coded	UPC 6-Digit	Weight (lbs.)
901-03020W00501	618	<b>5</b>	5	Yes	437662	0.62	<b>903-41150201</b>	725	<b>5</b>	60	Yes	436627	0.0375
901-03020W00501	653	<b>5</b>	5	Yes	437662	0.62	<b>903-41151001</b>	725	<b>5</b>	60	Yes	436610	0.07
901-03020W01001	618	<b>1</b>	1	Yes	437655	1.4	<b>903-41151601</b>	725	<b>5</b>	60	Yes	436603	0.0833
901-03020W01001	653	<b>1</b>	1	Yes	437655	1.4	<b>903-41161001</b>	725	<b>5</b>	60	Yes	436573	0.03
901-03020W01005	618	<b>1</b>	1	Yes	437839	1.35	<b>903-41162001</b>	725	<b>5</b>	60	Yes	436566	0.0933
901-03020W01005	653	<b>1</b>	1	Yes	437839	1.35	<b>903-41201001</b>	725	<b>5</b>	60	Yes	436559	0.07
901-03020W04005	618	<b>1</b>	1	Yes	437785	4.1	<b>903-41201601</b>	725	<b>5</b>	60	Yes	436542	0.11
901-03020W04005	653	<b>1</b>	1	Yes	437785	4.1	<b>903-41203001</b>	725	<b>5</b>	60	Yes	436535	0.165
901-03053W00101	653	<b>5</b>	5	Yes	437587	0.27	<b>903-41251601</b>	726	<b>5</b>	60	Yes	436511	0.095
901-03053W03005	653	<b>1</b>	1	Yes	437518	6.5	<b>903-41252001</b>	726	<b>5</b>	60	Yes	436504	0.12
901-03103W00251	653	<b>10</b>	10	Yes	437433	0.745	<b>903-41253001</b>	726	<b>5</b>	60	Yes	436498	0.15
901-03103W01005	653	<b>1</b>	1	Yes	437372	3	<b>903-41302001</b>	726	<b>5</b>	60	Yes	436481	0.11
901-03103W03005	653	<b>1</b>	1	Yes	437327	9.1	<b>903-440201</b>	726	<b>5</b>	60	Yes	436474	0.04
901-03163W00251	653	<b>5</b>	5	Yes	437204	1.07	<b>903-441001</b>	726	<b>5</b>	60	Yes	436320	0.0558
901-03163W01005	653	<b>1</b>	1	Yes	437136	3.97	<b>903-441601</b>	726	<b>5</b>	60	Yes	436313	0.07
901-03163W02005	653	<b>1</b>	1	Yes	437082	8.7	<b>903-442001</b>	726	<b>5</b>	60	Yes	436306	0.09
901-10	747	<b>10</b>	100	No	507624	0.0415	<b>903-45021001</b>	726	<b>5</b>	40	Yes	436467	0.0538
901-12	747	<b>10</b>	100	No	507631	0.044	<b>903-45051001</b>	726	<b>5</b>	60	Yes	436344	0.0658
901-16	747	<b>10</b>	100	No	507648	0.048	<b>903-45100201</b>	726	<b>5</b>	60	Yes	436443	0.0533
901-20	747	<b>10</b>	100	No	507655	0.0465	<b>903-45101601</b>	726	<b>5</b>	60	Yes	436436	0.0692
901-24	747	<b>10</b>	100	No	507662	0.052	<b>903-45151001</b>	726	<b>5</b>	60	Yes	436429	0.1192
901-28	747	<b>10</b>	100	No	507679	0.0709	<b>903-45161001</b>	726	<b>5</b>	60	Yes	436405	0.0683
901-32	747	<b>10</b>	100	No	507686	0.058	<b>903-45162001</b>	726	<b>5</b>	60	Yes	436399	0.0875
902	626	<b>50</b>	50	Yes	507693	0.196	<b>903-45201601</b>	726	<b>5</b>	60	Yes	436375	0.0967
90201	626	<b>5</b>	100	No	450500	0.2	<b>903-461601</b>	726	<b>5</b>	60	Yes	436368	0.0842
902-125001	757	<b>2</b>	24	Yes	436931	0.06	<b>903-671601</b>	725	<b>5</b>	60	Yes	436351	0.1333
902-126001	757	<b>2</b>	24	Yes	436924	0.07	<b>903-L99531</b>	727	<b>1</b>	5	No	450616	0.62
902-135002	757	<b>2</b>	24	Yes	436900	0.1	<b>903-L99560</b>	727	<b>1</b>	5	No	450623	0.67
903-120201	725	<b>5</b>	60	Yes	436887	0.0258	<b>903-L99593</b>	727	<b>1</b>	5	No	450630	0.63
903-120501	725	<b>5</b>	60	Yes	436870	0.02	<b>903-L99625</b>	727	<b>1</b>	5	No	450647	0.76
903-121001	725	<b>5</b>	60	Yes	436863	0.05	<b>903-L99656</b>	727	<b>1</b>	5	No	450654	0.79
903-121501	725	<b>5</b>	60	Yes	436856	0.04	<b>903-L99690</b>	727	<b>1</b>	5	No	450661	0.83
903-121601	725	<b>5</b>	60	Yes	436849	0.04	<b>903-L99781</b>	727	<b>1</b>	4	No	450678	0.9625
903-122001	725	<b>5</b>	60	Yes	436832	0.06	<b>903-L99812</b>	727	<b>1</b>	4	No	450685	0.975
903-122501	725	<b>5</b>	40	Yes	436825	0.05	<b>904-120201</b>	731	<b>5</b>	60	Yes	436290	0.02
903-123001	725	<b>5</b>	60	Yes	436818	0.1467	<b>904-120501</b>	731	<b>5</b>	60	Yes	436283	0.02
903-123301	725	<b>5</b>	60	Yes	735089	0.172	<b>904-121001</b>	731	<b>5</b>	60	Yes	436276	0.02
903-26162001	725	<b>5</b>	60	Yes	436771	0.1433	<b>904-121501</b>	731	<b>5</b>	60	Yes	436269	0.02
903-400201	725	<b>5</b>	60	Yes	436757	0.0392	<b>904-121601</b>	731	<b>5</b>	60	Yes	436252	0.02
903-401001	725	<b>5</b>	60	Yes	436733	0.05	<b>904-122001</b>	731	<b>5</b>	60	Yes	436245	0.04
903-401601	725	<b>5</b>	60	Yes	436726	0.07	<b>904-122501</b>	731	<b>5</b>	60	Yes	436238	0.02
903-402001	725	<b>5</b>	60	Yes	436719	0.1	<b>904-123001</b>	731	<b>5</b>	60	Yes	436221	0.03
903-403001	726	<b>5</b>	60	Yes	436702	0.1708	<b>904-124001</b>	731	<b>5</b>	60	Yes	436214	0.05
903-404001	726	<b>5</b>	60	Yes	436696	0.042	<b>904-125001</b>	731	<b>2</b>	24	Yes	436207	0.1
903-41021001	725	<b>5</b>	60	Yes	436689	0.04	<b>904-126001</b>	731	<b>2</b>	24	Yes	436184	0.1521
903-41050201	725	<b>5</b>	60	Yes	436672	0.05	<b>904-127001</b>	731	<b>1</b>	4	Yes	436160	0.425
903-41051001	725	<b>5</b>	60	Yes	436665	0.05	<b>904-13100501</b>	731	<b>5</b>	60	Yes	436153	0.02
903-41100201	725	<b>5</b>	60	Yes	436658	0.04	<b>904-13161001</b>	731	<b>5</b>	60	Yes	436146	0.02
903-41101601	725	<b>5</b>	60	Yes	436641	0.05	<b>904-13201601</b>	731	<b>5</b>	60	Yes	436122	0.02
903-41102001	725	<b>5</b>	60	Yes	436634	0.0875	<b>904-13252001</b>	731	<b>5</b>	60	Yes	436108	0.03



Item No	Page No	Min Qty	Case Qty	UPC Bar-Coded	UPC 6-Digit	Weight (lbs.)	Item No	Page No	Min Qty	Case Qty	UPC Bar-Coded	UPC 6-Digit	Weight (lbs.)
904-200201	731	5	60	Yes	436092	0.05	904-41100101	732	5	60	Yes	435477	0.02
904-200501	731	5	60	Yes	436085	0.0233	904-41101601	732	5	60	Yes	435460	0.02
904-201001	731	5	60	Yes	436078	0.02	904-41102001	732	5	60	Yes	435453	0.05
904-201601	731	5	60	Yes	436054	0.04	904-41103001	732	5	60	Yes	435446	0.03
904-202000	731	1	1	No	436047	9.1	904-41151001	732	5	60	Yes	435439	0.0308
904-202001	731	5	60	Yes	436030	0.0425	904-41160201	732	5	60	Yes	435422	0.02
904-202501	731	5	60	Yes	436016	0.04	904-41161001	732	5	60	Yes	435415	0.02
904-203001	731	5	60	Yes	436009	0.08	904-41162001	732	5	60	Yes	435408	0.035
904-204001	731	5	60	Yes	435996	0.07	904-41163001	732	5	60	Yes	435392	0.03
904-2120203001	732	5	60	Yes	468901	0.0458	904-41201001	732	5	60	Yes	435385	0.02
904-22161001	732	5	60	Yes	435958	0.0333	904-41201601	732	5	60	Yes	435378	0.04
904-22162001	732	5	60	Yes	435941	0.02	904-41203001	732	5	60	Yes	435361	0.04
904-22201601	732	5	60	Yes	435934	0.03	904-41251601	732	5	60	Yes	435330	0.02
904-25101	731	5	60	Yes	435903	0.0267	904-41252001	732	5	60	Yes	435323	0.03
904-251601	731	5	60	Yes	435880	0.02	904-41253001	732	5	60	Yes	435316	0.03
904-252001	731	5	60	Yes	435866	0.02	904-41302001	732	5	60	Yes	435309	0.03
904-252501	731	5	60	Yes	435842	0.02	904-41304001	732	5	60	Yes	435293	0.04
904-253001	731	5	60	Yes	435835	0.03	904-41402001	732	5	60	Yes	435286	0.05
904-254001	731	5	60	Yes	435828	0.0767	904-41403001	732	5	60	Yes	435279	0.04
904-255001	731	2	24	Yes	435811	0.16	904-41504001	732	2	16	Yes	435262	0.1281
904-271001	733	5	60	Yes	435798	0.02	904-457001	733	1	4	Yes	435231	0.3375
904-271601	733	5	60	Yes	435781	0.03	905	626	1	1	No	507709	10.5
904-272001	733	5	60	Yes	435774	0.03	905	657	1	1	No	507709	10.5
904-273001	733	5	60	Yes	435767	0.05	905-050402	747	5	60	No	435224	0.0458
904-275001	733	2	24	Yes	435750	0.1854	905-050602	747	5	60	No	435217	0.0958
904-276001	733	2	24	Yes	435743	0.2208	905-050802	747	5	60	No	435200	0.0427
904-28101601	733	5	60	Yes	435736	0.02	905-051202	747	5	60	No	435194	0.04
904-28102001	733	5	60	Yes	435729	0.02	905-052402	747	5	60	No	435170	0.0617
904-28161001	733	5	60	Yes	435712	0.03	905-053602	747	5	60	No	435163	0.0717
904-28162001	733	5	60	Yes	435705	0.04	905-055602	747	10	60	No	435156	0.05
904-28163001	733	5	60	Yes	435699	0.04	905-057202	747	10	60	No	435149	0.1083
904-28201001	733	5	60	Yes	435682	0.03	905-058802	747	10	60	No	435132	0.115
904-28201601	733	5	60	Yes	435675	0.03	905-160602	747	10	120	No	435101	0.1138
904-28203001	733	5	60	Yes	435668	0.0525	905-160802	747	10	120	No	435095	0.0496
904-28252001	733	5	60	Yes	435637	0.03	905-163602	747	1	10	No	435026	0.13
904-28253001	733	5	60	Yes	435620	0.04	905-164002	747	1	10	No	435019	0.06
904-28302001	733	5	60	Yes	435613	0.05	905-PK	626	50	50	No	500564	0.2146
904-28304001	733	5	60	Yes	435606	0.06	905-PK	657	50	50	No	500564	0.2146
904-284001	733	5	60	Yes	435590	0.08	906	626	1	1	No	507716	18
904-28403001	733	5	60	Yes	435583	0.07	906	657	1	1	No	507716	18
904-28405001	733	5	60	Yes	435576	0.11	906-0402	747	5	60	Yes	435002	0.02
904-401001	732	5	60	Yes	435569	0.02	906-0502	747	5	60	Yes	434999	0.01
904-401601	732	5	60	Yes	435552	0.02	906-0602	747	5	60	Yes	434975	0.02
904-402001	732	5	60	Yes	435545	0.04	906-0802	747	5	60	Yes	434968	0.02
904-403001	732	5	60	Yes	435538	0.03	906-1002	747	5	40	Yes	434944	0.02
904-404001	732	5	60	Yes	435521	0.05	906-1202	747	10	120	Yes	434937	0.0271
904-405001	732	4	4	Yes	435514	0.1375	906-1402	747	10	120	Yes	434920	0.0375
904-407001	733	1	4	Yes	469021	0.275	906-PK	626	50	50	No	200266	0.372
904-41050201	732	5	60	Yes	435491	0.0258	906-PK	657	50	50	No	200266	0.372
904-41051001	732	5	60	Yes	435484	0.0283	907-010003	678	5	60	Yes	434913	0.0233

Supply

Drainage

Support

Specialties

Appendix

# Numerical Index

Supply

Drainage

Support

Specialties

Appendix

Item No	Page No	Min Qty	Case Qty	UPC Bar-Coded	UPC 6-Digit	Weight (lbs.)	Item No	Page No	Min Qty	Case Qty	UPC Bar-Coded	UPC 6-Digit	Weight (lbs.)
907-010103	678	<b>5</b>	60	Yes	434906	0.0333	907-13201001	671	<b>5</b>	40	Yes	434357	0.13
907-010203	678	<b>10</b>	120	Yes	434890	0.01	907-1916161001	672	<b>5</b>	60	Yes	434340	0.1967
907-010225	678	<b>5</b>	60	Yes	434883	0.05	907-1920201601	672	<b>5</b>	60	Yes	434333	0.3075
907-010503	678	<b>5</b>	20	Yes	434876	0.02	907-1930302001	672	<b>2</b>	24	Yes	434326	0.5396
907-011003	678	<b>10</b>	120	Yes	434869	0.03	907-201001	672	<b>5</b>	60	Yes	434319	0.15
907-011025	678	<b>5</b>	20	Yes	434852	0.09	907-2120200201	613	<b>5</b>	60	Yes	434272	0.1983
907-011603	678	<b>5</b>	60	Yes	434845	0.04	907-221602	613	<b>10</b>	120	No	434258	0.1425
907-011625	678	<b>5</b>	60	Yes	434838	0.13	907-24101001	672	<b>5</b>	60	Yes	206145	0.175
907-012003	678	<b>5</b>	60	Yes	434814	0.05	907-24202001	672	<b>5</b>	60	Yes	206299	0.3867
907-012503	678	<b>5</b>	60	Yes	434807	0.0567	907-251601	672	<b>5</b>	60	Yes	434241	0.1792
907-013003	678	<b>5</b>	60	Yes	434784	0.07	907-27101601	676	<b>5</b>	60	Yes	434234	0.13
907-020203	678	<b>10</b>	120	Yes	434753	0.0142	907-27101605	676	<b>5</b>	20	Yes	434227	0.585
907-020210	678	<b>1</b>	480	Yes	434746	0.0074	907-28102001	676	<b>1</b>	10	Yes	434203	0.18
907-020225	678	<b>1</b>	60	Yes	434739	0.0158	907-40021001	673	<b>5</b>	60	Yes	434173	0.0742
907-020510	678	<b>10</b>	3000	Yes	434722	0.01	907-40101001	673	<b>5</b>	60	Yes	434166	0.07
907-021000	678	<b>1</b>	50	Yes	434715	0.0308	907-40102005	673	<b>1</b>	60	Yes	469175	0.4358
907-021003	678	<b>10</b>	120	Yes	434708	0.02	907-4016200505	673	<b>5</b>	60	Yes	434142	0.5708
907-021025	678	<b>5</b>	60	Yes	434692	0.0325	907-4020200505	673	<b>5</b>	60	Yes	434128	0.5892
907-021600	678	<b>1</b>	50	Yes	434685	0.11	907-40303001	673	<b>2</b>	24	Yes	434111	0.25
907-022003	678	<b>5</b>	20	Yes	434647	0.02	907-41102001	673	<b>5</b>	60	Yes	434159	0.11
907-022010	678	<b>1</b>	150	Yes	434630	0.015	907-41201005	673	<b>5</b>	20	Yes	457004	0.52
907-050202	678	<b>10</b>	120	Yes	434623	0.02	907-41202001	673	<b>5</b>	60	Yes	434135	0.12
907-050502	678	<b>5</b>	60	Yes	434616	0.03	907-43102001	676	<b>5</b>	60	Yes	434104	0.0708
907-051002	678	<b>5</b>	60	Yes	434609	0.03	907-44021001	675	<b>5</b>	60	Yes	434098	0.0683
907-051602	678	<b>5</b>	60	Yes	434586	0.02	907-44101601	675	<b>5</b>	60	Yes	434081	0.0708
907-052002	678	<b>5</b>	20	Yes	434579	0.03	907-4410200505	675	<b>5</b>	60	Yes	434067	0.4275
907-080003	679	<b>5</b>	60	Yes	434562	0.04	907-44162001	675	<b>5</b>	60	Yes	434050	0.1017
907-080103	679	<b>5</b>	60	Yes	434555	0.04	907-44203001	675	<b>5</b>	60	Yes	469182	-
907-080203	679	<b>10</b>	120	Yes	434548	0.04	907-45102001	675	<b>5</b>	60	Yes	434074	0.09
907-080225	679	<b>25</b>	70	Yes	434531	0.3	907-45202001	675	<b>5</b>	60	Yes	434043	0.12
907-080503	679	<b>5</b>	60	Yes	434524	0.065	907-47100200	673	<b>1</b>	10	No	434036	3.95
907-081000	679	<b>100</b>	25	Yes	434517	1.466	907-47100201	673	<b>5</b>	60	Yes	430861	0.25
907-081003	679	<b>10</b>	120	Yes	434500	0.02	907-47101601	673	<b>5</b>	20	Yes	430847	0.105
907-081025	679	<b>5</b>	20	Yes	434494	0.41	907-47151001	673	<b>5</b>	60	Yes	430830	0.0783
907-081603	679	<b>5</b>	40	Yes	434487	0.09	907-47161001	673	<b>5</b>	40	Yes	430823	0.06
907-081625	679	<b>5</b>	60	Yes	434470	0.575	907-480201	676	<b>5</b>	60	Yes	434012	0.055
907-082003	679	<b>5</b>	40	Yes	434463	0.13	907-481001	676	<b>5</b>	40	Yes	434005	0.09
907-082025	679	<b>5</b>	30	Yes	434456	0.905	907-490201	678	<b>5</b>	60	Yes	433992	0.03
907-083003	679	<b>5</b>	60	Yes	434449	0.27	907-490501	678	<b>5</b>	60	Yes	433985	0.0392
907-120201	671	<b>5</b>	60	Yes	434432	0.0633	907-491001	678	<b>5</b>	60	Yes	433954	0.05
907-120205	671	<b>1</b>	60	Yes	455703	0.2225	907-491010	678	<b>5</b>	60	Yes	433947	0.2042
907-120210	671	<b>5</b>	20	Yes	434425	0.44	907-491601	678	<b>5</b>	40	Yes	433930	0.04
907-121001	671	<b>5</b>	60	Yes	434418	0.085	907-492001	678	<b>5</b>	40	Yes	433923	0.04
907-121005	671	<b>5</b>	60	Yes	433435	0.3217	907-541001	673	<b>5</b>	60	Yes	430854	0.16
907-121601	671	<b>5</b>	60	Yes	434401	0.1125	907-58101001	674	<b>5</b>	60	Yes	503459	0.0592
907-121605	671	<b>5</b>	60	Yes	455727	0.248	907-58161601	674	<b>5</b>	60	Yes	503466	0.0725
907-122001	671	<b>5</b>	60	Yes	434388	0.15	907-58202001	674	<b>5</b>	60	Yes	503473	0.12
907-122005	671	<b>1</b>	50	Yes	455734	0.688	907-981001	613	<b>5</b>	60	Yes	502933	0.1542
907-123001	671	<b>2</b>	24	Yes	434371	0.3333	907-L990201	679	<b>10</b>	120	Yes	206169	0.0271
907-13100201	671	<b>5</b>	60	Yes	207098	0.0775	908-061002	679	<b>5</b>	60	Yes	433909	0.06

Item No	Page No	Min Qty	Case Qty	UPC Bar-Coded	UPC 6-Digit	Weight (lbs.)	Item No	Page No	Min Qty	Case Qty	UPC Bar-Coded	UPC 6-Digit	Weight (lbs.)
908-061602	679	5	20	Yes	433886	0.07	909-13050201	671	5	40	Yes	433350	0.07
908-070202	679	5	60	Yes	433879	0.0483	909-13100201	671	5	60	Yes	434364	0.06
908-071002	679	5	60	Yes	433862	0.0558	909-13160201	671	5	20	Yes	433343	0.13
908-081001	679	5	60	Yes	433855	0.0342	909-13161001	671	5	60	Yes	433336	0.11
908-12020201	683	5	60	Yes	433848	0.02	909-13161060	671	5	60	Yes	433329	0.4492
908-12101001	683	5	60	Yes	433831	0.055	909-13201001	671	5	60	Yes	433312	0.15
908-12161601	683	5	60	Yes	433824	0.06	909-13201601	671	5	60	Yes	433305	0.15
908-13100201	683	5	60	Yes	433817	0.03	909-13201605	671	5	15	Yes	433299	0.5
908-13161001	683	5	60	Yes	433800	0.05	909-13302001	671	2	24	Yes	433282	0.2917
908-2002020201	683	5	60	Yes	433794	0.03	909-14100201	673	5	60	Yes	433275	0.0775
908-2010101001	683	5	60	Yes	433787	0.06	909-183001	672	2	24	Yes	433244	0.8396
908-2210101001	683	5	60	Yes	433770	0.05	909-200201	672	5	60	Yes	433213	0.08
908-25020201	683	5	60	Yes	433763	0.02	909-201001	672	5	120	Yes	433206	0.15
908-25101001	683	5	60	Yes	433756	0.0583	909-201601	672	5	40	Yes	433190	0.2
908-27020201	684	5	60	Yes	433749	0.02	909-202001	672	5	60	Yes	433251	0.3
908-27021001	684	5	60	Yes	433732	0.03	909-21100201	672	5	60	Yes	433237	0.15
908-27021601	684	5	60	Yes	433725	0.03	909-250201	672	5	40	Yes	433169	0.04
908-27101001	684	5	60	Yes	433718	0.03	909-251001	672	5	40	Yes	433152	0.05
908-40020201	683	5	60	Yes	433701	0.02	909-251601	672	5	20	Yes	433145	0.15
908-40021001	683	5	60	Yes	433695	0.02	909-252001	672	5	60	Yes	433138	0.25
908-40021601	683	5	60	Yes	433688	0.02	909-263001	672	2	24	Yes	433121	0.6688
908-40100201	683	5	60	Yes	433671	0.0425	909-28010201	677	5	60	Yes	433114	0.07
908-40101001	683	5	60	Yes	433664	0.03	909-28021601	677	5	60	Yes	433107	0.1142
908-40101601	683	5	60	Yes	433657	0.03	909-28051001	677	5	60	Yes	433091	0.0708
908-40161601	683	5	60	Yes	433633	0.04	909-29021001	677	5	40	Yes	433077	0.09
908-40162001	683	5	60	Yes	433626	0.05	909-29101601	677	5	60	Yes	433060	0.05
909-030200	679	1	50	Yes	433619	0.224	909-29162001	677	5	20	Yes	433053	0.1
909-030203	679	5	60	Yes	433602	0.025	909-30020201	677	5	40	Yes	433046	0.07
909-030503	679	5	60	Yes	433596	0.0292	909-30101001	677	5	40	Yes	433039	0.25
909-031000	679	1	50	Yes	433589	0.126	909-30102001	677	5	40	Yes	433022	0.05
909-031003	679	5	60	Yes	433572	0.0358	909-30161601	677	5	40	Yes	433015	0.15
909-031603	679	5	60	Yes	433565	0.0392	909-30201601	677	5	20	Yes	433008	0.175
909-032003	679	5	60	Yes	433558	0.0425	909-30202001	677	5	40	Yes	432995	0.15
909-032010	679	1	10	Yes	433541	0.01	909-32102001	677	5	60	Yes	432988	0.1483
909-070201	679	10	120	Yes	433534	0.03	909-32202001	677	5	60	Yes	432971	0.2542
909-070501	679	5	60	Yes	433510	0.04	909-40000201	674	5	60	Yes	432964	0.0583
909-071001	679	10	120	Yes	433503	0.04	909-40010201	674	5	60	Yes	432957	0.0583
909-071601	679	5	20	Yes	433497	0.06	909-40021001	673	5	60	Yes	432933	0.07
909-072001	679	5	40	Yes	433480	0.07	909-40100201	674	5	60	Yes	432896	0.0867
909-073001	679	5	60	Yes	433473	0.1125	909-40101601	674	5	60	Yes	432872	0.1
909-120001	671	5	60	Yes	433466	0.05	909-40162001	674	5	60	Yes	432834	0.1
909-120101	671	5	60	Yes	433459	0.06	909-40201601	674	5	20	Yes	432827	0.15
909-120201	671	10	120	Yes	433442	0.05	909-40203001	674	5	60	Yes	432803	0.1
909-120501	671	5	60	Yes	433428	0.08	909-40253001	674	5	60	Yes	432797	0.25
909-121001	671	10	120	Yes	433411	0.1	909-40303001	674	2	24	Yes	432780	0.2
909-121601	671	5	60	Yes	433404	0.11	909-41020201	673	5	60	Yes	432940	0.05
909-122001	671	5	60	Yes	433398	0.1	909-41021601	673	5	60	Yes	432926	0.05
909-122501	671	5	60	Yes	433381	0.3008	909-41022001	673	5	60	Yes	432919	0.1158
909-123001	671	2	24	Yes	433374	0.3	909-41050200	674	5	60	Yes	432773	0.0633
909-123009	671	3	9	Yes	433367	1.5944	909-41051001	673	5	20	Yes	432902	0.07

Supply

Drainage

Support

Specialties

Appendix

# Numerical Index

Supply

Drainage

Support

Specialties

Appendix

Item No	Page No	Min Qty	Case Qty	UPC Bar-Coded	UPC 6-Digit	Weight (lbs.)	Item No	Page No	Min Qty	Case Qty	UPC Bar-Coded	UPC 6-Digit	Weight (lbs.)
909-41101001	674	<b>5</b>	60	Yes	432889	0.05	<b>921-7W</b>	621	<b>20</b>	100	No	407290	0.0349
909-41102001	674	<b>10</b>	120	Yes	432865	0.05	<b>921-7WPK2</b>	621	10	10	Yes	407283	0.0511
909-41103001	674	<b>5</b>	20	Yes	432858	0.15	<b>922-5W</b>	621	<b>25</b>	25	No	507983	0.1038
909-41161601	674	<b>5</b>	60	Yes	432841	0.1	<b>922-5WPK2</b>	621	10	10	Yes	407320	0.1091
909-41163001	674	<b>5</b>	60	Yes	432759	0.1367	<b>922-6W</b>	621	<b>25</b>	25	No	507990	0.1028
909-41202001	674	<b>5</b>	60	Yes	432810	0.1283	<b>922-6WPK2</b>	621	10	10	Yes	407344	0.1081
909-41302001	674	<b>2</b>	24	Yes	432193	0.2667	<b>923-1036C00</b>	622	<b>12</b>	120	Yes	455925	0.03
909-41303007	674	<b>5</b>	30	Yes	431707	0.4883	<b>923-1612C01</b>	624	<b>12</b>	12	Yes	409041	0.0542
909-43102001	676	<b>5</b>	40	Yes	431158	0.05	<b>923-1613C01</b>	624	<b>12</b>	12	Yes	709677	0.0625
909-44021001	675	<b>5</b>	60	Yes	430991	0.05	<b>923-1614C01</b>	624	<b>12</b>	120	Yes	709684	0.05
909-44021601	675	<b>5</b>	20	Yes	430984	0.09	<b>923-1615C01</b>	624	<b>12</b>	12	Yes	502964	0.0792
909-44022001	675	<b>5</b>	40	Yes	430977	0.05	<b>923-1616C01</b>	624	<b>12</b>	12	Yes	502971	0.075
909-44101601	675	<b>5</b>	60	Yes	430946	0.05	<b>923-1622C01</b>	624	<b>12</b>	12	Yes	409089	0.0542
909-44103001	675	<b>5</b>	60	Yes	430922	0.1825	<b>923-1623C01</b>	624	<b>12</b>	12	Yes	409164	0.0542
909-44161601	675	<b>5</b>	20	Yes	430915	0.1	<b>923-1624C01</b>	624	<b>12</b>	12	Yes	708991	0.075
909-44162001	675	<b>5</b>	60	Yes	430908	0.1	<b>923-1625C01</b>	624	<b>12</b>	12	Yes	455796	0.0708
909-44203001	675	<b>5</b>	20	Yes	430885	0.17	<b>923-1626C01</b>	624	<b>12</b>	12	Yes	409263	0.0625
909-44303001	675	<b>2</b>	24	Yes	430878	0.2521	<b>923-1627C01</b>	624	<b>12</b>	12	Yes	709004	0.0917
909-45020201	675	<b>5</b>	60	Yes	431004	0.0383	<b>923-2321C00</b>	623	<b>25</b>	100	Yes	455802	0.045
909-45022001	675	<b>5</b>	40	Yes	430977	0.05	<b>923-2322C00</b>	623	<b>25</b>	100	Yes	455819	0.05
909-45051001	675	<b>5</b>	20	Yes	430960	0.07	<b>923-2326C00</b>	623	<b>5</b>	100	Yes	455826	0.0815
909-45101001	675	<b>5</b>	40	Yes	430953	0.07	<b>923-2335C00</b>	623	<b>5</b>	100	Yes	455833	0.1
909-45102001	675	<b>10</b>	120	Yes	430939	0.05	<b>923-2336C00</b>	623	<b>5</b>	100	Yes	502544	0.0885
909-45202001	675	<b>5</b>	60	Yes	430892	0.1258	<b>923-2435C00</b>	623	<b>25</b>	25	Yes	455857	0.062
909-991001	613	<b>5</b>	60	Yes	434302	0.15	<b>923-2436C00</b>	623	<b>25</b>	25	Yes	455864	0.052
909-99100201	613	<b>5</b>	60	Yes	434296	0.15	<b>923-2521C04</b>	623	1	200	Yes	455871	0.12
910-2	622	<b>25</b>	250	Yes	408068	0.031	<b>923-2522C04</b>	623	1	200	Yes	455888	0.098
910-3	622	<b>25</b>	250	Yes	408143	0.0302	<b>923-2525C04</b>	623	1	200	Yes	455895	0.28
911-1	622	<b>25</b>	250	Yes	709721	0.03	<b>923-2526C04</b>	623	1	200	Yes	457554	0.222
911-2	622	<b>25</b>	250	Yes	408105	0.0298	<b>923-2527C04</b>	623	1	200	Yes	455901	0.232
911-3	622	<b>25</b>	250	Yes	408181	0.022	<b>923-2536C04</b>	623	1	200	Yes	455918	0.166
911-4	622	<b>25</b>	250	Yes	408235	0.0284	<b>926-2</b>	621	<b>12</b>	120	Yes	430069	0.0157
911-6	622	<b>25</b>	250	Yes	408273	0.0266	<b>926-2W</b>	621	<b>12</b>	120	Yes	508010	0.0145
911-6D	622	<b>25</b>	250	Yes	507785	0.06	<b>926-3</b>	621	<b>12</b>	120	Yes	430144	0.0279
911-7	622	<b>25</b>	250	Yes	408297	0.0459	<b>926-3W</b>	621	<b>12</b>	120	Yes	508034	0.0165
920-1W	621	<b>50</b>	500	No	407030	0.0151	<b>926-4</b>	621	<b>12</b>	120	Yes	430212	0.025
920-2W	621	<b>25</b>	250	No	407061	0.0156	<b>926-4W</b>	621	<b>12</b>	120	Yes	508058	0.0321
920-2WPK2	621	10	10	Yes	407047	0.0463	<b>927-2</b>	622	<b>12</b>	120	Yes	495426	0.019
920-3W	621	<b>25</b>	250	No	407146	0.0154	<b>927-2W</b>	622	<b>12</b>	120	Yes	508072	0.025
920-3WPK2	621	10	10	Yes	407122	0.0459	<b>927-3</b>	622	<b>12</b>	120	Yes	430182	0.025
920-4W	621	<b>20</b>	100	No	407214	0.0143	<b>927-3W</b>	622	<b>12</b>	120	Yes	508096	0.0228
920-4WPK2	621	1	1	Yes	407207	0.1014	<b>927-4</b>	622	<b>12</b>	120	Yes	430236	0.0279
921-2W	621	<b>50</b>	500	No	407108	0.0115	<b>927-4W</b>	622	<b>12</b>	120	Yes	508119	0.023
921-2WPK2	621	10	10	Yes	407085	0.0483	<b>927-5</b>	622	<b>12</b>	120	Yes	709356	0.0438
921-3W	621	<b>50</b>	500	No	407184	0.0152	<b>927-6</b>	622	<b>12</b>	120	Yes	430274	0.038
921-3WPK2	621	10	10	Yes	407160	0.0488	<b>927-6W</b>	622	<b>12</b>	120	Yes	508133	0.033
921-4W	621	<b>20</b>	100	No	407238	0.0429	<b>927-7</b>	622	<b>12</b>	120	Yes	430298	0.0446
921-4WPK2	621	10	10	Yes	407221	0.1293	<b>927-7W</b>	622	<b>12</b>	120	Yes	508157	0.041
921-6W	621	<b>20</b>	100	No	407276	0.0379	<b>927-8W</b>	622	<b>12</b>	120	Yes	508164	0.0452
921-6WPK2	621	<b>10</b>	10	Yes	407269	0.0541	<b>928-12</b>	640	<b>50</b>	500	No	508171	0.0067

Item No	Page No	Min Qty	Case Qty	UPC Bar-Coded	UPC 6-Digit	Weight (lbs.)	Item No	Page No	Min Qty	Case Qty	UPC Bar-Coded	UPC 6-Digit	Weight (lbs.)
928-125	640	<b>50</b>	500	No	508188	0.0055	930-250201	699	<b>5</b>	20	Yes	430373	0.08
928-125PK2	640	25	25	Yes	502131	0.08	930-251001	699	<b>5</b>	60	Yes	430366	0.05
928-12PK2	640	25	25	Yes	502124	0.0772	930-251601	699	<b>5</b>	40	Yes	430359	0.14
928-13	640	<b>50</b>	50	No	508195	0.0064	930-252001	699	<b>5</b>	60	Yes	430342	0.25
928-2	640	<b>50</b>	500	No	508201	0.0063	930-253001	699	<b>5</b>	40	Yes	206527	0.33
928-2PK2	640	25	25	Yes	502148	0.078	930-257001	699	<b>2</b>	24	Yes	430250	0.1562
928-3	640	<b>50</b>	500	No	508218	0.0116	930-270201	699	<b>5</b>	60	Yes	430243	0.04
929-01302001	112	<b>5</b>	20	Yes	430786	0.45	930-270210	699	<b>1</b>	80	Yes	430199	0.3644
929-01303001	112	<b>5</b>	60	Yes	430779	0.45	930-271001	699	<b>5</b>	60	Yes	430175	0.09
929-02302001	112	<b>5</b>	20	Yes	430762	0.7	930-271010	699	<b>1</b>	50	Yes	430151	0.79
930-120201	698	<b>5</b>	60	Yes	429308	0.05	930-271601	699	<b>5</b>	60	Yes	430137	0.1
930-121001	698	<b>5</b>	60	Yes	429292	0.043	930-271610	699	<b>1</b>	12	Yes	430113	1.2375
930-121601	698	<b>5</b>	60	Yes	429285	0.057	930-272001	699	<b>5</b>	60	Yes	430106	0.2217
930-121610	698	<b>1</b>	50	Yes	430731	0.559	930-273001	699	<b>5</b>	60	Yes	430090	0.35
930-122001	698	<b>5</b>	60	Yes	430724	0.1417	930-380201	699	<b>5</b>	60	Yes	429988	0.0733
930-122010	698	<b>1</b>	30	Yes	430717	0.9317	930-381005	699	<b>5</b>	60	Yes	429971	0.1133
930-123001	698	<b>5</b>	60	Yes	470454	0.1483	930-381601	699	<b>5</b>	60	Yes	429964	0.1408
930-13100201	698	<b>5</b>	60	Yes	429186	0.06	930-46101001	676	<b>5</b>	60	Yes	722324	-
930-13160201	698	<b>5</b>	20	Yes	430694	0.06	930-490201	699	<b>5</b>	40	Yes	429933	0.03
930-13161001	698	<b>5</b>	60	Yes	430687	0.05	930-491001	699	<b>5</b>	60	Yes	429919	0.04
930-13200201	698	<b>5</b>	20	Yes	430663	0.125	930-491010	699	<b>1</b>	100	Yes	429902	0.192
930-13201001	698	<b>5</b>	60	Yes	430656	0.05	930-491601	699	<b>5</b>	60	Yes	429896	0.05
930-13201601	698	<b>5</b>	60	Yes	430649	0.1	930-491610	699	<b>1</b>	60	Yes	429889	0.4808
930-13301601	698	<b>5</b>	60	Yes	430625	0.15	930-492001	699	<b>5</b>	60	Yes	429872	0.05
930-13302001	698	<b>5</b>	60	Yes	430618	0.16	930-493001	699	<b>5</b>	20	Yes	429858	0.1
930-13605001	698	<b>2</b>	24	Yes	430601	0.8854	930-493010	699	<b>1</b>	25	Yes	429841	1.274
930-15100201	700	<b>5</b>	60	Yes	430595	0.03	930-500201	701	<b>5</b>	60	Yes	429834	0.05
930-15100210	700	<b>1</b>	150	Yes	430588	0.2327	930-501001	701	<b>5</b>	60	Yes	429810	0.04
930-15160201	700	<b>5</b>	40	Yes	430571	0.06	930-501010	701	<b>1</b>	150	Yes	429803	0.2603
930-15160210	700	<b>1</b>	100	Yes	430564	0.353	930-501601	701	<b>5</b>	60	Yes	429797	0.05
930-15161001	700	<b>5</b>	60	Yes	430557	0.05	930-502001	701	<b>5</b>	60	Yes	429766	0.09
930-15161010	700	<b>1</b>	100	Yes	430540	0.3205	930-502010	701	<b>1</b>	45	Yes	429759	0.7522
930-15200201	700	<b>5</b>	60	Yes	430533	0.1	930-503001	701	<b>5</b>	60	Yes	470492	0.1525
930-15201001	700	<b>5</b>	60	Yes	430526	0.05	930-504001	701	<b>2</b>	24	Yes	429742	0.2604
930-15201601	700	<b>5</b>	60	Yes	430519	0.05	930-506001	701	<b>2</b>	24	Yes	429735	0.5229
930-15201610	700	<b>1</b>	60	Yes	430502	0.5183	930-510201	701	<b>5</b>	60	Yes	429728	0.0367
930-15301001	700	<b>5</b>	60	Yes	430496	0.2092	930-511001	701	<b>5</b>	60	Yes	429711	0.0492
930-15301601	700	<b>5</b>	60	Yes	430489	0.1692	930-511601	701	<b>5</b>	60	Yes	429698	0.0758
930-15302001	700	<b>5</b>	60	Yes	430472	0.1	930-512001	701	<b>5</b>	60	Yes	429674	0.1
930-15403001	700	<b>2</b>	24	Yes	430458	0.25	930-513001	701	<b>5</b>	60	Yes	429667	0.1475
930-16161001	700	<b>5</b>	60	Yes	430441	0.0342	930-521001	701	<b>5</b>	60	Yes	429650	0.0392
930-16201601	700	<b>5</b>	60	Yes	430434	0.0575	930-522001	701	<b>5</b>	60	Yes	429643	0.0817
930-16302001	700	<b>5</b>	60	Yes	430410	0.0733	930-530201	701	<b>5</b>	40	Yes	429636	0.03
930-200201	698	<b>5</b>	20	Yes	455956	0.07	930-540201	698	<b>5</b>	60	Yes	429629	0.17
930-201001	698	<b>5</b>	60	Yes	456694	0.275	930-541001	698	<b>5</b>	60	Yes	429612	0.3133
930-201601	698	<b>5</b>	60	Yes	502551	0.1383	930-543001	698	<b>5</b>	60	Yes	429605	0.77
930-202001	698	<b>5</b>	60	Yes	502797	0.2767	930-544001	698	<b>2</b>	24	Yes	429599	1.03
930-203001	698	<b>5</b>	60	Yes	206565	0.4425	930-56100201	699	<b>5</b>	60	Yes	429582	0.0558
930-21161001	698	<b>5</b>	60	Yes	430403	0.2075	930-56161001	699	<b>5</b>	60	Yes	429544	0.0983
930-21201601	698	<b>5</b>	60	Yes	430397	0.3183	930-56201601	699	<b>5</b>	60	Yes	429520	0.12

Supply

Drainage

Support

Specialties

Appendix

# Numerical Index

Supply

Drainage

Support

Specialties

Appendix

Item No	Page No	Min Qty	Case Qty	UPC Bar-Coded	UPC 6-Digit	Weight (lbs.)	Item No	Page No	Min Qty	Case Qty	UPC Bar-Coded	UPC 6-Digit	Weight (lbs.)
930-610201	700	5	60	Yes	429506	0.04	931-181601	706	5	60	Yes	456854	0.2408
930-611001	700	5	60	Yes	429490	0.07	931-200201	706	5	20	Yes	456946	0.135
930-611601	700	5	60	Yes	429483	0.06	931-202001	706	5	60	Yes	455963	0.3
930-611610	700	1	60	Yes	429476	0.63	931-203001	706	5	60	Yes	455970	0.4
930-612001	700	5	60	Yes	429469	0.1	931-204001	706	2	24	Yes	455987	0.75
930-613001	700	5	60	Yes	429452	0.19	931-205001	706	2	24	Yes	455994	1.3458
930-62100201	700	5	60	Yes	429445	0.0808	931-206001	706	2	12	Yes	456007	1.8458
930-62161001	700	5	60	Yes	429414	0.1092	931-207001	706	2	24	Yes	456687	2.675
930-62201001	700	5	60	Yes	429391	0.0967	931-250201	706	5	20	Yes	428936	0.1025
930-62201601	700	5	60	Yes	429377	0.0958	931-251001	706	5	60	Yes	428929	0.1283
930-62302001	700	5	60	Yes	429360	0.2117	931-251601	706	5	40	Yes	428912	0.1125
930-641001	701	5	60	Yes	429346	0.0567	931-252001	706	5	60	Yes	456014	0.25
930-641601	701	5	60	Yes	429339	0.0667	931-253001	706	5	60	Yes	456021	0.3
930-642001	701	5	20	Yes	502759	0.49	931-254001	706	2	24	Yes	430335	0.57
930-643001	701	5	60	Yes	429315	0.14	931-255001	706	2	24	Yes	456755	1.0146
931-122001	705	5	60	Yes	429278	0.05	931-256001	706	2	12	Yes	456038	1.4833
931-123001	705	5	60	Yes	429247	0.1	931-270201	706	5	60	Yes	456830	0.0825
931-124001	705	2	24	Yes	429230	0.43	931-271001	706	5	60	Yes	456908	0.1275
931-125001	705	2	24	Yes	429216	0.7375	931-271601	706	5	60	Yes	456793	0.165
931-126001	705	2	24	Yes	429209	0.9	931-272001	706	5	60	Yes	456045	0.2567
931-127001	705	2	24	Yes	429193	1.5292	931-273001	706	5	60	Yes	456052	0.3808
931-13100201	705	5	60	Yes	430700	0.1	931-274001	706	2	24	Yes	428905	0.7271
931-13160201	705	5	20	Yes	429179	0.145	931-275001	706	2	24	Yes	456809	1.0271
931-13161001	705	5	60	Yes	429162	0.1358	931-276001	706	2	24	Yes	456069	1.325
931-13200201	705	5	60	Yes	429155	0.1725	931-277001	706	2	24	Yes	456076	2.0833
931-13201001	705	5	60	Yes	429148	0.1792	931-370201	706	5	20	Yes	456083	0.115
931-13201601	705	5	60	Yes	456885	0.1892	931-371601	706	5	60	Yes	430014	0.1542
931-13302001	705	5	60	Yes	429124	0.2783	931-372001	706	5	60	Yes	430007	0.2483
931-13402001	705	2	24	Yes	429117	0.34	931-373001	706	5	60	Yes	456090	0.3642
931-13403001	705	2	24	Yes	429100	0.3	931-374001	706	5	20	Yes	456106	0.605
931-13503001	705	2	24	Yes	429094	0.6292	931-382001	706	5	60	Yes	429957	0.235
931-13504001	705	2	24	Yes	429087	0.6979	931-383001	706	5	60	Yes	429940	0.3183
931-13604001	705	2	24	Yes	429070	0.8146	931-490201	707	5	40	Yes	428899	0.055
931-13705001	705	2	24	Yes	429063	1.2396	931-491001	707	5	60	Yes	428882	0.0775
931-13706001	705	2	24	Yes	429056	1.2646	931-491601	707	5	60	Yes	428875	0.1108
931-15100201	707	5	60	Yes	429049	0.07	931-492001	707	5	60	Yes	456656	0.1467
931-15160201	707	5	40	Yes	429032	0.0962	931-493001	707	5	60	Yes	456113	0.23
931-15161001	707	5	20	Yes	429025	0.1025	931-494001	707	2	24	Yes	456120	0.28
931-15200201	707	5	60	Yes	429018	0.1292	931-495001	707	2	24	Yes	456137	0.5729
931-15201001	707	5	60	Yes	429001	0.1067	931-496001	707	2	24	Yes	428868	0.85
931-15201601	707	5	60	Yes	428998	0.1092	931-497001	707	2	24	Yes	456724	1.1458
931-15302001	707	5	60	Yes	428981	0.1758	931-501010	708	5	60	Yes	456144	0.0633
931-15402001	707	2	24	Yes	428974	0.3792	931-502001	708	5	60	Yes	456151	0.1325
931-15503001	707	2	24	Yes	428967	0.55	931-503001	708	5	60	Yes	428851	0.15
931-15504001	707	2	24	Yes	428950	0.4729	931-504001	708	5	20	Yes	456823	0.245
931-15604001	707	2	24	Yes	428943	0.6854	931-505001	708	2	24	Yes	456168	0.4229
931-15605001	707	2	24	Yes	455932	0.5042	931-507001	708	2	24	Yes	206466	0.7688
931-15705001	707	2	16	Yes	455949	0.9625	931-510201	708	5	60	Yes	456175	0.0592
931-15706001	707	2	24	Yes	206459	0.8042	931-511001	708	5	60	Yes	456182	0.0775
931-181001	706	5	60	Yes	457035	0.1558	931-511601	708	5	60	Yes	456199	0.1025

Item No	Page No	Min Qty	Case Qty	UPC Bar-Coded	UPC 6-Digit	Weight (lbs.)	Item No	Page No	Min Qty	Case Qty	UPC Bar-Coded	UPC 6-Digit	Weight (lbs.)
931-512001	708	5	60	Yes	456205	0.1392	933-613001	712	5	60	Yes	428462	0.05
931-513001	708	5	60	Yes	456212	0.1692	933-614001	712	5	60	Yes	428455	0.05
931-541601	705	5	60	Yes	456229	0.4	933-822001	711	5	60	Yes	428448	0.11
931-542001	705	5	60	Yes	456236	0.4842	933-823001	711	5	60	Yes	428431	0.1
931-543001	705	5	60	Yes	456243	0.64	933-832001	711	5	60	Yes	428424	0.11
931-544001	705	2	24	Yes	428844	0.9896	933-8320P01	711	5	60	Yes	428417	0.86
931-545001	705	2	10	Yes	456250	1.44	933-833001	711	5	60	Yes	428400	0.1
931-546001	705	2	12	Yes	456267	1.9333	933-8330P01	711	5	60	Yes	428394	0.1
931-547001	705	2	12	Yes	206473	2.6875	933-842001	711	5	60	Yes	428387	0.11
931-56100201	707	5	60	Yes	456274	0.0883	933-8420P01	711	5	60	Yes	428370	0.11
931-56161001	707	5	60	Yes	456892	0.115	933-843001	711	5	60	Yes	428363	0.1
931-562001	707	5	60	Yes	456281	0.1917	933-8430P01	711	5	60	Yes	428356	0.1
931-610201	707	5	60	Yes	456984	0.0617	933-845001	711	1	2	Yes	428349	0.575
931-611001	707	5	60	Yes	456304	0.0858	933-8450P01	711	2	24	Yes	428332	0.4688
931-611601	707	5	60	Yes	456663	0.1108	933-8460P01	711	2	24	Yes	428325	0.7875
931-612001	707	5	60	Yes	457066	10.9	933-8470P01	711	2	24	Yes	428318	0.7021
931-613001	707	5	60	Yes	456311	0.24	933-852001	711	1	5	Yes	428301	0.26
931-640201	708	5	60	Yes	428837	0.0542	933-853001	711	1	5	Yes	428295	0.23
931-641001	708	5	60	Yes	428820	0.0658	934-02001	715	5	60	Yes	428288	0.03
931-641601	708	5	60	Yes	428813	0.0875	934-021.501	715	5	60	Yes	428271	0.04
931-642001	708	5	60	Yes	428806	0.0942	934-022.501	715	5	60	Yes	428264	0.0858
931-643001	708	5	60	Yes	428790	0.135	934-02201	715	5	40	Yes	428257	0.05
932-15201601	700	5	60	Yes	428783	0.07	934-02401	715	5	20	Yes	428240	0.11
932-15302001	700	5	60	Yes	428776	0.1267	934-02501	715	5	20	Yes	428233	0.1375
933-122001	711	5	60	Yes	428769	0.04	934-10001	715	5	60	Yes	428202	0.06
933-123001	711	5	60	Yes	428752	0.06	934-101.501	715	5	60	Yes	428196	0.06
933-124001	711	5	60	Yes	428745	0.13	934-102.501	715	5	60	Yes	428189	0.1142
933-15161001	712	5	60	Yes	428738	0.02	934-10201	715	5	60	Yes	428172	0.09
933-15201001	712	5	60	Yes	428721	0.0308	934-103.505	715	5	60	Yes	471710	0.145
933-15201601	712	5	60	Yes	428714	0.0308	934-10301	715	5	60	Yes	428158	0.1
933-15301601	712	5	60	Yes	428707	0.03	934-10401	715	5	60	Yes	428141	0.19
933-15302001	712	5	60	Yes	428691	0.05	934-10501	715	5	40	Yes	428127	0.1962
933-15402001	712	2	24	Yes	428684	0.06	934-10601	715	5	30	Yes	428110	0.275
933-15403001	712	2	24	Yes	428677	0.05	934-16001	715	5	60	Yes	428103	0.05
933-15503001	712	2	24	Yes	428660	0.1	934-161.501	715	5	60	Yes	428097	0.05
933-15504001	712	2	24	Yes	428653	0.15	934-162.501	715	5	20	Yes	428080	0.15
933-15604001	712	2	24	Yes	428646	0.1	934-16201	715	5	40	Yes	428073	0.11
933-15605001	712	2	24	Yes	428639	0.07	934-163.501	715	5	60	Yes	428066	0.195
933-202001	711	5	60	Yes	428622	0.09	934-16301	715	5	20	Yes	428059	0.15
933-252001	712	5	60	Yes	428608	0.07	934-16401	715	5	20	Yes	428042	0.24
933-253001	712	5	60	Yes	428585	0.09	934-16501	715	5	60	Yes	428035	0.15
933-254001	712	2	24	Yes	428561	0.18	934-16601	715	5	60	Yes	428028	0.325
933-510201	712	5	60	Yes	428547	0.02	934-20001	715	5	60	Yes	428011	0.17
933-511001	712	5	60	Yes	428530	0.02	934-201.501	715	5	60	Yes	428004	0.09
933-511601	712	5	60	Yes	428523	0.02	934-202.501	715	5	60	Yes	427991	0.15
933-512001	712	5	60	Yes	428516	0.02	934-20201	715	5	60	Yes	427984	0.1383
933-513001	712	5	60	Yes	428509	0.03	934-203.501	715	5	60	Yes	427977	0.2342
933-611001	712	5	60	Yes	428493	0.02	934-20301	715	5	60	Yes	427960	0.19
933-611601	712	5	60	Yes	428486	0.0333	934-204.501	715	5	60	Yes	427953	0.2933
933-612001	712	5	60	Yes	428479	0.03	934-20401	715	5	60	Yes	427946	0.2

Supply

Drainage

Support

Specialties

Appendix

# Numerical Index

Supply

Drainage

Support

Specialties

Appendix

Item No	Page No	Min Qty	Case Qty	UPC Bar-Coded	UPC 6-Digit	Weight (lbs.)	Item No	Page No	Min Qty	Case Qty	UPC Bar-Coded	UPC 6-Digit	Weight (lbs.)
934-205.501	715	5	60	Yes	427939	0.3683	935-30201	717	5	60	Yes	206442	0.1792
934-20501	715	5	60	Yes	427922	0.34	935-303.501	717	5	60	Yes	472441	0.3433
934-20601	715	5	60	Yes	427915	0.35	935-30301	717	5	60	Yes	457097	0.2792
934-30001	715	5	60	Yes	427908	0.12	935-304.501	717	5	60	Yes	472458	0.4567
934-301.501	715	5	60	Yes	427892	0.1	935-30401	717	5	60	Yes	456991	23.95
934-302.501	715	5	60	Yes	427885	0.22	935-305.501	717	5	60	Yes	472465	0.5642
934-30201	715	5	60	Yes	427878	0.1	935-30501	717	5	60	Yes	456762	0.4967
934-30301	715	5	60	Yes	427854	0.27	935-30601	717	5	60	Yes	427502	0.6192
934-30401	715	5	40	Yes	427830	0.3	935-40001	717	2	24	Yes	456878	0.1833
934-30501	715	5	60	Yes	427823	0.4283	935-40201	717	2	24	Yes	457059	0.2467
934-30601	715	5	60	Yes	427816	0.4758	935-40301	717	2	24	Yes	427496	0.3979
934-40001	716	2	24	Yes	427809	0.16	935-40601	717	2	24	Yes	427472	20.95
934-402.501	716	2	24	Yes	427793	0.3	935-50001	717	2	24	Yes	456847	7.15
934-40201	716	2	24	Yes	427786	0.2333	935-50301	717	2	24	Yes	427465	0.575
934-40401	716	2	24	Yes	427762	0.5646	935-50401	717	2	24	Yes	427458	0.7917
934-70401	716	2	24	Yes	427717	1.1	935-50601	717	2	24	Yes	427441	1.2229
935-02001	716	5	60	Yes	427694	0.0392	935-60001	718	2	24	Yes	427434	0.375
935-021.501	716	5	60	Yes	427687	0.0492	935-60301	718	2	24	Yes	427427	0.6958
935-022.501	716	5	20	Yes	427670	0.09	935-60601	718	2	24	Yes	427410	1.4792
935-02201	716	5	40	Yes	427663	0.0512	935-70001	718	2	24	Yes	456748	13.8
935-02301	716	5	20	Yes	427656	0.06	935-70301	718	2	24	Yes	456779	20.95
935-02401	716	5	20	Yes	427649	0.11	935-70401	718	2	24	Yes	502704	1.3
935-02501	716	5	60	Yes	427632	2.75	935-70601	718	2	24	Yes	456700	44.5
935-02601	716	5	60	Yes	427625	9.25	936-16001	716	5	60	Yes	427403	0.0533
935-10001	717	5	60	Yes	427618	0.0492	936-162.501	716	5	60	Yes	427397	0.1367
935-101.501	717	5	60	Yes	427601	0.0692	936-16201	716	5	60	Yes	427380	0.3492
935-102.501	717	5	60	Yes	457011	6.35	936-163.501	716	5	60	Yes	427373	0.1825
935-10201	717	5	60	Yes	427595	0.0808	936-16301	716	5	60	Yes	427366	0.1567
935-10301	717	5	60	Yes	427588	0.115	936-16401	716	5	60	Yes	427359	0.22
935-10401	717	5	60	Yes	427571	0.1567	936-16501	716	5	60	Yes	427342	0.2792
935-10501	717	5	40	Yes	456915	7.85	936-16601	716	5	60	Yes	427335	0.3292
935-10601	717	5	60	Yes	427564	0.2317	936-20001	716	5	60	Yes	427328	0.0725
935-16001	717	5	60	Yes	427557	0.0625	936-201.501	716	5	60	Yes	427311	0.095
935-161.501	717	5	60	Yes	427540	0.0792	936-20201	716	5	60	Yes	427304	0.1275
935-162.501	717	5	20	Yes	456816	0.13	936-203.501	716	5	60	Yes	427298	0.225
935-16201	717	5	40	Yes	427533	0.115	936-20301	716	5	60	Yes	427281	0.1908
935-16301	717	5	20	Yes	456922	2.95	936-20401	716	5	60	Yes	427274	0.2617
935-16501	717	5	60	Yes	427526	0.2783	936-20501	716	5	60	Yes	427267	0.33
935-16601	717	5	60	Yes	456786	0.3342	936-20601	716	5	60	Yes	427250	0.4
935-20001	717	5	60	Yes	427519	0.0858	937-1230201	737	5	60	Yes	204547	0.1658
935-201.501	717	5	60	Yes	206428	0.1142	937-123030101	737	5	60	Yes	427236	0.1175
935-202.501	717	5	60	Yes	457073	10.7	937-2330101	739	5	20	Yes	427229	0.25
935-20201	717	5	60	Yes	457127	0.1425	937-273030101	738	5	20	Yes	427212	0.4775
935-20301	717	5	60	Yes	457080	13.05	937-4930100	738	5	60	Yes	427205	0.0617
935-20401	717	5	60	Yes	456977	17.85	937-4930101	738	5	60	Yes	427199	0.07
935-20501	717	5	60	Yes	456953	22.45	937-65303001	738	5	60	Yes	427175	0.15
935-20601	717	5	60	Yes	456960	0.46	937-66302001	738	5	40	Yes	427168	0.16
935-30001	717	5	60	Yes	206435	0.1242	937-66302501	738	5	20	Yes	427151	0.18
935-301.501	717	5	60	Yes	457028	7.65	937-6730101	737	5	60	Yes	427144	0.1683
935-302.501	717	5	60	Yes	456939	0.2233	937-67303020101	737	5	60	Yes	427120	0.18



Item No	Page No	Min Qty	Case Qty	UPC Bar-Coded	UPC 6-Digit	Weight (lbs.)	Item No	Page No	Min Qty	Case Qty	UPC Bar-Coded	UPC 6-Digit	Weight (lbs.)
937-683020101	737	<b>5</b>	60	Yes	427137	0.16	<b>963-01</b>	783	<b>24</b>	240	No	508751	0.031
937-6930101	737	<b>5</b>	60	Yes	427113	0.14	<b>963-05</b>	783	<b>5</b>	5	Yes	508768	5.276
937-703020101	737	<b>5</b>	60	Yes	427106	0.11	<b>963-15PK2</b>	783	20	20	Yes	517012	1.002
937-7130101	737	<b>5</b>	60	Yes	427090	0.18	<b>963-HTL-FE128</b>	787	<b>4</b>	4	Yes	972249	15.225
937-7230101	737	<b>5</b>	60	Yes	427083	0.15	<b>963-HTL-FE20</b>	787	<b>12</b>	12	Yes	137174	2.5208
937-723030101	737	<b>5</b>	60	Yes	427076	0.1375	<b>963-HTL-FE32</b>	787	<b>12</b>	12	Yes	922015	3.9375
937-733020101	737	<b>5</b>	60	Yes	427069	0.12	<b>963-HTL-FE64</b>	787	<b>4</b>	4	Yes	962028	7.95
937-7530101	737	<b>5</b>	40	Yes	427052	0.15	<b>965-204</b>	775	<b>25</b>	25	No	508836	0.2
937-753030201	737	<b>5</b>	60	Yes	427045	0.19	<b>965-208</b>	775	<b>25</b>	25	No	508843	0.314
937-763002101	737	<b>5</b>	20	Yes	427038	0.0975	<b>965-212</b>	775	<b>25</b>	25	No	508850	0.38
937-763020101	737	<b>5</b>	60	Yes	427021	0.12	<b>965-804</b>	775	<b>25</b>	25	No	508867	0.252
937-763020201	737	<b>5</b>	60	Yes	427007	0.1383	<b>965-808</b>	775	<b>25</b>	25	No	508874	0.416
937-773030101	738	<b>5</b>	40	Yes	426994	0.1	<b>965-812</b>	775	<b>25</b>	25	No	508881	0.424
937-782030101	738	<b>5</b>	40	Yes	426987	0.1	<b>969-014440304001</b>	122	<b>2</b>	24	Yes	426581	0.55
937-782530101	738	<b>5</b>	40	Yes	426970	0.14	<b>970-112</b>	213	<b>20</b>	20	Yes	302120	0.56
937-783016201	738	<b>5</b>	60	Yes	426963	0.1	<b>970-117</b>	213	<b>12</b>	12	Yes	508911	1.392
937-783020201	738	<b>5</b>	40	Yes	426956	0.11	<b>970-208</b>	213	1	12	Yes	302083	0.75
937-793002201	738	<b>5</b>	60	Yes	426932	0.09	<b>970-214</b>	213	1	12	Yes	302144	1.767
937-803030201	737	<b>5</b>	20	Yes	426918	0.25	<b>970-214S</b>	213	1	6	Yes	100702	1.775
937-8520300201	738	<b>5</b>	40	Yes	502636	0.2675	<b>970-269S</b>	213	1	6	Yes	100719	0.75
937-95301001	739	<b>5</b>	60	Yes	206121	0.1392	<b>971-1414</b>	163	1	1	No	101143	6.85
937-96301001	739	<b>5</b>	60	Yes	206138	0.1158	<b>971-1414</b>	213	1	1	No	101143	6.85
938-1230101	743	<b>5</b>	60	Yes	207326	0.055	<b>971-1430</b>	163	1	1	No	101150	12.85
938-4930101	744	<b>5</b>	60	Yes	426901	0.03	<b>971-1430</b>	213	1	1	No	101150	12.85
938-65303001	744	<b>5</b>	40	Yes	426888	0.03	<b>971-77</b>	213	<b>1</b>	1	No	718761	-
938-66301001	744	<b>5</b>	60	Yes	426871	0.03	<b>971-77</b>	300	<b>1</b>	1	No	718761	-
938-66301601	744	<b>5</b>	60	Yes	426864	0.04	<b>971-99</b>	213	<b>1</b>	8	No	718778	2.93
938-66302001	744	<b>5</b>	40	Yes	426840	0.1	<b>971-99</b>	300	<b>1</b>	8	No	718778	2.93
938-66302501	744	<b>5</b>	40	Yes	426826	0.04	<b>972-10</b>	639	1	50	No	508942	0.5353
938-673030101	743	<b>5</b>	60	Yes	426710	0.0492	<b>972-100</b>	639	1	12	Yes	508959	0.1319
938-683020101	743	<b>5</b>	60	Yes	426703	0.03	<b>972-15</b>	639	1	50	No	508973	0.6496
938-693030101	743	<b>5</b>	60	Yes	426727	0.04	<b>972-20</b>	639	1	50	No	508997	0.7796
938-713030101	743	<b>5</b>	60	Yes	207081	0.0417	<b>972-30</b>	639	1	50	No	509000	0.6816
938-7230101	743	<b>5</b>	60	Yes	426680	0.0508	<b>972-32</b>	639	1	18	Yes	566140	0.7917
938-7530101	743	<b>5</b>	60	Yes	426697	0.0792	<b>972-32RB</b>	639	1	18	Yes	509239	0.8408
938-773030201	744	<b>5</b>	60	Yes	426819	0.04	<b>972-32SN</b>	639	1	18	Yes	509055	0.8396
938-783010201	744	<b>5</b>	60	Yes	426796	0.04	<b>972-35</b>	639	1	50	No	509024	0.658
938-783016201	744	<b>5</b>	60	Yes	426789	0.04	<b>972-36</b>	639	1	18	Yes	556806	0.9376
938-783020201	744	<b>5</b>	60	Yes	426772	0.03	<b>972-361PK2</b>	639	6	6	Yes	501868	1.078
938-783025201	744	<b>5</b>	60	Yes	426765	0.04	<b>972-362PK2</b>	639	6	6	Yes	501875	1.044
958-44322001	695	<b>1</b>	1	No	426604	13.5	<b>972-363PK2</b>	639	<b>6</b>	6	Yes		1.78
958-48322001	695	<b>5</b>	60	Yes	426598	0.155	<b>972-36RB</b>	639	1	18	Yes	509109	0.9161
958-L493201	695	<b>5</b>	60	Yes	206152	-	<b>972-36SN</b>	639	1	18	Yes	509123	0.8114
961-20	775	24	24	No	508584	0.1617	<b>972-3RA</b>	639	<b>1</b>	10	No	501837	0.3012
961-20155	625	1	25	Yes	508607	0.034	<b>973-0010C01</b>	600	<b>8</b>	8	Yes	426574	1.15
961-22	775	24	24	No	508645	0.196	<b>973-0010PB04</b>	600	<b>4</b>	4	Yes	426550	1.5
961-32	775	1	12	No	508669	0.2745	<b>973-0010SN04</b>	600	<b>4</b>	4	Yes	426543	1.45
961-34	775	1	12	No	508676	0.6495	<b>973-0015C04</b>	600	<b>8</b>	8	Yes	503138	1.4562
961-6	625	25	25	No	508690	0.062	<b>973-0015RB04</b>	600	<b>1</b>	8	Yes	503190	1.4625
961-7	625	<b>25</b>	25	No	508706	0.11	<b>973-0102C04</b>	602	<b>1</b>	12	Yes	426536	1.7625

Supply

Drainage

Support

Specialties

Appendix

# Numerical Index

Supply

Drainage

Support

Specialties

Appendix

Item No	Page No	Min Qty	Case Qty	UPC Bar-Coded	UPC 6-Digit	Weight (lbs.)	Item No	Page No	Min Qty	Case Qty	UPC Bar-Coded	UPC 6-Digit	Weight (lbs.)
973-0202C04	602	<b>8</b>	8	Yes	503251	-	974-68000304	641	<b>1</b>	1	Yes	426246	3
973-0302C04	601	<b>1</b>	8	Yes	426512	1.5	974-68100304	641	<b>1</b>	1	Yes	426239	4.7
973-0402C04	601	<b>8</b>	8	Yes	472861	1.1	974-68200301	641	<b>1</b>	4	Yes	426222	8.0125
973-0600C04	600	<b>1</b>	3	Yes	472878	3.6	974-686003C04	641	<b>1</b>	24	Yes	426215	2.3438
973-0600SN/RB04	600	<b>1</b>	3	Yes	426505	3.6	974-84410301	641	<b>1</b>	50	Yes	472939	-
973-1010PB04	600	<b>4</b>	4	Yes	426482	1.45	974-85020300	641	<b>25</b>	25	Yes	456496	0.218
973-1010SN04	600	<b>4</b>	4	Yes	426475	1.25	974-85033201	641	<b>1</b>	100	Yes	456519	0.08
973-2015C04	599	<b>1</b>	10	Yes	456366	3.845	974-95650004	627	<b>1</b>	12	Yes	456571	1.735
973-2302C04	599	<b>1</b>	12	Yes	456373	3.7542	974-95650304	627	<b>1</b>	12	Yes	456588	1.6958
973-2319C04	599	<b>1</b>	10	Yes	426420	3.9062	975-080201	690	<b>5</b>	60	Yes	426192	0.05
973-3015C04	599	<b>1</b>	16	Yes	426468	3.54	975-080501	690	<b>5</b>	60	Yes	426185	0.07
973-3015PB04	599	<b>1</b>	16	Yes	426451	3.54	975-081001	690	<b>10</b>	120	Yes	426161	0.05
973-3015SN04	599	<b>1</b>	4	Yes	207685	-	975-081010	690	<b>5</b>	60	Yes	426154	0.41
973-3016C04	599	<b>1</b>	3	Yes	426444	4.18	975-081601	690	<b>5</b>	60	Yes	426147	0.08
973-3102C04	599	<b>4</b>	16	Yes	426437	3.37	975-081610	690	<b>5</b>	60	No	426130	0.5342
973-3302C04	599	<b>1</b>	12	Yes	456397	3.625	975-082001	690	<b>5</b>	60	Yes	426123	0.12
973-3702C04	600	<b>1</b>	3	Yes	426413	3.5	975-082010	690	<b>5</b>	30	Yes	426116	1.3383
973-3900C04	600	<b>1</b>	10	Yes	426406	5.45	975-082501	690	<b>5</b>	60	Yes	426109	0.02
973-5104C01	602	<b>1</b>	24	Yes	456410	1.1792	975-083001	690	<b>5</b>	24	Yes	426086	0.4062
973-5201C01	602	<b>8</b>	8	Yes	426390	1.3	975-091001	690	<b>5</b>	60	Yes	426079	0.08
973-5202C04	602	<b>8</b>	8	Yes	503206	1.3562	975-091601	690	<b>5</b>	60	Yes	426055	0.11
973-5401C04	601	<b>1</b>	12	Yes	426383	1.36	975-091610	690	<b>5</b>	30	Yes	426048	0.815
973-6101C01	602	<b>8</b>	8	Yes	426376	2.45	975-092001	690	<b>5</b>	60	Yes	426024	0.14
973-6301C04	601	<b>8</b>	8	Yes	426369	2.65	975-092010	690	<b>5</b>	30	No	426017	1.475
973-7201C01	602	<b>8</b>	8	Yes	426352	0.8	975-093001	690	<b>5</b>	60	Yes	426000	0.4458
973-7401C04	601	<b>1</b>	12	Yes	207692	-	975-101001	690	<b>10</b>	120	Yes	425997	0.09
973-8301C01	601	<b>1</b>	8	Yes	426345	1.7562	975-101601	690	<b>10</b>	120	Yes	425980	0.13
973-8301PB04	601	<b>4</b>	4	Yes	426338	2.1375	975-102001	690	<b>10</b>	120	Yes	425973	0.07
973-9000C01	602	<b>1</b>	25	Yes	426321	0.3	975-103001	687	<b>2</b>	24	Yes	425966	0.5958
973-9015R101	602	<b>6</b>	120	Yes	426314	0.1346	975-120201	687	<b>5</b>	20	Yes	425959	0.06
973-9090C04	603	<b>1</b>	1	Yes	472892	0.29	975-121001	687	<b>5</b>	60	Yes	425928	0.11
973-9097C01	603	<b>1</b>	20	Yes	426307	1.305	975-121601	687	<b>5</b>	60	Yes	425904	0.15
973-9099C01	603	<b>1</b>	20	Yes	426291	0.08	975-122001	687	<b>5</b>	20	Yes	425881	0.2
973-9100C04	603	<b>1</b>	12	Yes	472908	-	975-13100201	687	<b>5</b>	20	Yes	425874	0.0825
973-9300C04	603	<b>1</b>	12	Yes	456441	0.5042	975-13161001	687	<b>5</b>	60	Yes	425867	0.12
973-9392C04	603	<b>10</b>	200	Yes	426284	0.15	975-13161010	687	<b>5</b>	15	Yes	425850	0.5233
973-9601	603	<b>1</b>	25	Yes	472915	0.042	975-13201001	687	<b>5</b>	60	Yes	425843	0.1575
974-60100	602	<b>1</b>	20	Yes	509048	0.2925	975-13201601	687	<b>5</b>	60	Yes	425836	0.1592
974-60101	602	<b>1</b>	10	Yes	472922	-	975-200201	687	<b>5</b>	20	Yes	425829	0.095
974-60102	602	<b>1</b>	12	Yes	509062	0.192	975-201001	687	<b>5</b>	60	Yes	425812	0.2017
974-60116	602	<b>12</b>	120	No	509093	0.0549	975-201601	687	<b>5</b>	60	Yes	425775	0.2583
974-60300	641	<b>1</b>	6	Yes	509130	0.5823	975-2020202001	687	<b>5</b>	20	Yes	425744	0.4275
974-60306	640	<b>1</b>	25	Yes	509161	0.2651	975-2110100201	687	<b>5</b>	60	Yes	425737	0.175
974-60308	640	<b>1</b>	25	Yes	509185	0.4074	975-2116161001	687	<b>5</b>	60	Yes	425713	0.2442
974-60310	641	<b>1</b>	10	Yes	509208	0.1176	975-2120201601	687	<b>5</b>	60	Yes	425706	0.3408
974-60315	641	<b>1</b>	10	Yes	509215	0.85	975-251001	688	<b>5</b>	40	Yes	425683	0.2
974-660303L04	641	<b>50</b>	50	No	426277	0.479	975-251010	688	<b>5</b>	15	Yes	425690	0.8633
974-662303L04	641	<b>50</b>	50	No	426260	0.56	975-251601	688	<b>5</b>	40	Yes	425676	0.21
974-6633032H04	641	<b>1</b>	1	Yes	426253	2.85	975-25202001	688	<b>5</b>	60	Yes	425669	0.2
974-668303BH	641	<b>1</b>	1	Yes	502568	3.2	975-27020001	689	<b>10</b>	40	Yes	425652	0.06

Item No	Page No	Min Qty	Case Qty	UPC Bar-Coded	UPC 6-Digit	Weight (lbs.)	Item No	Page No	Min Qty	Case Qty	UPC Bar-Coded	UPC 6-Digit	Weight (lbs.)
975-2702001	689	5	60	Yes	425645	0.105	975-44252501	689	5	60	Yes	424983	0.2567
975-27100001	689	5	60	Yes	425638	0.0925	975-45101001	689	5	20	Yes	425119	0.0825
975-27100201	689	5	20	Yes	425621	0.16	975-45102001	689	10	120	Yes	425089	0.15
975-27101601	689	5	60	Yes	425607	0.14	975-45202001	689	5	40	Yes	425003	0.1525
975-27161001	689	5	40	Yes	425546	0.18	975-46161601	687	5	40	Yes	424907	0.2
975-27162001	689	5	40	Yes	425539	0.22	975-46202001	687	5	60	Yes	424891	0.25
975-27201601	689	5	20	Yes	425522	0.26	975-490201	690	5	60	Yes	424884	0.05
975-28102001	689	5	60	Yes	425577	0.19	975-490501	690	5	60	Yes	424877	0.05
975-31101001	690	5	20	Yes	425508	0.1575	975-491001	690	5	60	Yes	424860	0.05
975-31101601	690	5	60	Yes	425492	0.1767	975-491601	690	5	60	Yes	424853	0.07
975-31161001	690	5	60	Yes	425485	0.1492	975-492001	690	5	40	Yes	424846	0.11
975-31161601	690	5	20	Yes	425478	0.19	975-510205	691	5	20	Yes	424839	0.05
975-31201601	690	5	60	Yes	425454	0.2217	975-511005	691	5	60	Yes	424815	0.07
975-31202501	690	5	20	Yes	425447	0.355	975-511605	691	5	40	Yes	424808	0.07
975-40020001	688	5	40	Yes	425423	0.0575	975-512005	691	5	20	Yes	424792	0.17
975-40021001	688	5	40	Yes	425409	0.07	975-540201	687	5	60	Yes	424969	0.0933
975-40021601	688	5	60	Yes	425386	0.0917	975-L541001	687	5	60	Yes	424938	0.14
975-40050001	688	5	60	Yes	425379	0.0675	978-081001	692	5	60	Yes	424723	0.05
975-40050201	688	5	60	Yes	425362	0.0733	978-12101001	691	5	20	Yes	424716	0.0675
975-40100001	688	5	60	Yes	425355	0.0808	978-201001	691	5	60	Yes	424709	0.1517
975-401010	688	5	15	Yes	425331	0.4067	978-27101605	691	5	15	Yes	424693	0.57
975-40101601	688	5	60	Yes	425324	0.05	978-40101601	691	5	60	Yes	424686	0.0867
975-40101605	688	5	60	Yes	425294	0.4633	978-40102001	691	5	40	Yes	424679	0.11
975-40102501	688	5	60	Yes	425287	0.1625	978-44101001	691	5	60	Yes	424662	0.065
975-40161605	688	5	60	Yes	425256	0.54	978-44101601	691	5	60	Yes	424655	0.09
975-40162001	688	5	60	Yes	425263	0.1	978-47021001	692	5	40	Yes	424648	0.07
975-401625	688	5	15	Yes	425249	0.8	978-47101001	692	5	60	Yes	424631	0.07
975-40162501	688	5	60	Yes	425232	0.175	978-47101601	692	10	120	Yes	424617	0.0679
975-40201001	688	5	60	Yes	425225	0.1667	978-491001	692	5	60	Yes	424600	0.04
975-40201605	688	5	60	Yes	425201	0.7308	979-400201	695	5	60	Yes	424594	0.2483
975-40252501	688	5	60	Yes	425188	0.07	979-491601	695	5	60	Yes	424587	0.1875
975-41021601	688	5	60	Yes	425393	0.07	979-590201	695	5	60	Yes	424570	0.15
975-41101001	688	5	40	Yes	425300	0.05	979-600201	695	5	20	Yes	424563	0.24
975-41102001	688	10	120	Yes	425317	0.09	979-610201	695	5	60	Yes	424556	0.11
975-41161601	688	5	60	Yes	425270	0.12	980-5	587	100	100	No	504531	0.0825
975-41202001	688	5	60	Yes	425218	0.17	980-6	587	100	100	No	509260	0.0725
975-41203001	688	5	20	Yes	425195	0.22	980-7	587	10	10	Yes	715708	0.135
975-44020001	689	5	60	Yes	425171	0.0492	980-8	587	100	100	No	509277	0.079
975-44020201	689	5	20	Yes	425164	0.0825	981-5	587	100	100	No	509284	0.0595
975-44021001	689	5	60	Yes	425157	0.0742	981-6	587	100	100	No	509291	0.1025
975-44050201	689	5	60	Yes	425133	0.0275	981-7	587	10	10	Yes	715715	0.145
975-44101601	689	5	60	Yes	425096	0.09	981-8	587	50	500	No	502988	-
975-44102501	689	5	60	Yes	425072	0.1483	985-5	587	100	100	No	509307	0.0542
975-44161001	689	5	40	Yes	425065	0.11	985-6	587	100	100	No	509314	0.0625
975-44161005	689	5	60	Yes	425058	0.4467	985-8	587	100	100	No	509321	0.0725
975-44161605	689	5	60	Yes	425034	0.51	986-6	587	100	100	No	509338	0.0595
975-44162001	689	5	60	Yes	425041	0.12	988-5000	570	100	1000	No	456625	0.017
975-44162501	689	5	60	Yes	425027	0.1667	988-5100	570	100	1000	No	702081	-
975-442016	689	5	15	Yes	425010	0.6467	988-6	570	100	1000	No	509345	0.029
975-44202501	689	5	20	Yes	424990	0.18	988-6100	570	100	1000	No	456632	0.02

Supply

Drainage

Support

Specialties

Appendix

# Numerical Index

Supply

Drainage

Support

Specialties

Appendix

Item No	Page No	Min Qty	Case Qty	UPC Bar-Coded	UPC 6-Digit	Weight (lbs.)	Item No	Page No	Min Qty	Case Qty	UPC Bar-Coded	UPC 6-Digit	Weight (lbs.)
988-6GT	465	<b>25</b>	25	No	713827	0.042	<b>998-51162001</b>	753	<b>5</b>	20	Yes	424099	0.3475
988-6GT	467	<b>25</b>	25	No	713827	0.042	<b>999-211610V01</b>	752	<b>5</b>	60	Yes	424044	0.2067
988-6GT	568	<b>25</b>	25	No	713827	0.042	<b>999-56200201</b>	752	<b>5</b>	60	Yes	424037	0.1467
988-6GT	570	<b>25</b>	25	No	713827	0.042	<b>999-56300201</b>	752	<b>5</b>	60	Yes	424020	0.2342
990-20385	587	<b>25</b>	300	No	509352	0.0095							
990-7	587	<b>100</b>	1000	No	509376	0.0086							
991-6	570	<b>100</b>	1000	No	509383	0.0058							
991-6S	570	<b>100</b>	1000	No	702098	0.0054							
991-6S	587	<b>100</b>	1000	No	702098	0.0054							
995-20320	587	<b>25</b>	200	No	509390	0.0097							
995-20330	587	<b>25</b>	200	No	509406	0.0111							
995-20335	587	<b>25</b>	200	No	509413	0.0151							
995-20340	587	<b>25</b>	200	No	509420	0.0093							
995-5	587	<b>100</b>	1000	No	509437	0.0086							
995-6	587	<b>100</b>	1000	No	509444	0.0106							
995-8	587	<b>100</b>	1000	No	509451	0.0148							
996-500	570	<b>100</b>	1000	No	456649	0.0035							
996-5S	570	<b>100</b>	1000	No	702104	0.0034							
996-5S	587	<b>100</b>	1000	No	702104	0.0034							
996-6	570	<b>100</b>	1000	No	509468	0.0058							
996-6S	570	<b>100</b>	1000	No	702111	0.004							
996-6S	587	<b>100</b>	1000	No	702111	0.004							
996-8	570	<b>100</b>	1000	No	509475	0.0078							
996-8S	570	<b>100</b>	1000	No	702128	0.0061							
996-8S	587	<b>100</b>	1000	No	702128	0.0061							
996-L100201	701	<b>5</b>	60	Yes	206268	0.2575							
996-L101001	701	<b>5</b>	60	Yes	206251	0.2442							
996-L601001	727	<b>5</b>	60	Yes	206237	0.13							
996-L601601	727	<b>5</b>	60	Yes	206244	0.1442							
997-010201104001	751	<b>5</b>	60	Yes	424457	0.1242							
997-010206020601	751	<b>5</b>	60	Yes	424419	0.1175							
997-010206024001	751	<b>5</b>	60	Yes	424402	0.0975							
997-0102440244	751	<b>5</b>	60	Yes	424389	0.1058							
997-011006100601	751	<b>5</b>	60	Yes	424334	0.1717							
997-0202011040	751	<b>5</b>	60	Yes	424297	0.1192							
997-020201104001	751	<b>5</b>	60	Yes	424280	0.1192							
997-020206024001	751	<b>5</b>	60	Yes	424273	0.1017							
997-022590020601	752	<b>5</b>	60	Yes	424242	0.2217							
997-0242020201	751	<b>5</b>	60	Yes	424303	0.08							
997-400201	751	<b>5</b>	60	Yes	424433	0.09							
997-401001	751	<b>5</b>	60	Yes	424341	0.05							
997-42020201	751	<b>5</b>	40	Yes	424426	0.08							
997-940201	752	<b>5</b>	60	Yes	424228	0.2							
997-941001	752	<b>5</b>	40	Yes	424204	0.25							
998-011044104001	753	<b>5</b>	60	Yes	424143	0.2008							
998-011048104801	753	<b>5</b>	40	Yes	424129	0.32							
998-05024001	752	<b>5</b>	60	Yes	424082	0.05							
998-05104001	752	<b>5</b>	60	Yes	424051	0.08							
998-301001	753	<b>5</b>	20	Yes	424167	0.17							
998-51102001	753	<b>5</b>	20	Yes	424112	0.35							

DATE		
PAGE	OF	

### INSTRUCTIONS

1. Fill in all Bill to and Ship to information.
2. Complete one line for each item ordered and fully extend for item total. Add all lines for order total.
3. Fax or mail page(s) to factory, representative or wholesaler.

#### BILL TO

 new address

Qualified wholesale distributors only		
Purchase order no.		
Contact name		
Company		
Street address		
City		
State	Zip	
Phone	Fax	
Special instructions		

#### SHIP TO

 new address

Leave blank if same as "bill to"		
Purchase order no.		
Contact name		
Company		
Street address		
City		
State	Zip	
Phone	Fax	
Special instructions		

### ORDER

	Item No.	Description	Qty.	List Price Each	List Price Total	Mult.	Net Price Total
	1						
	2						
	3						
	4						
	5						
	6						
	7						
	8						
	9						
	10						
	11						
	12						
	13						
	14						
	15						
Signature / Date			Order Totals				

[www.siouxchief.com](http://www.siouxchief.com)

14940 Thunderbird Road  
 Kansas City, MO 64147  
**P** 1.800.821.3944  
**F** 1.800.758.5950



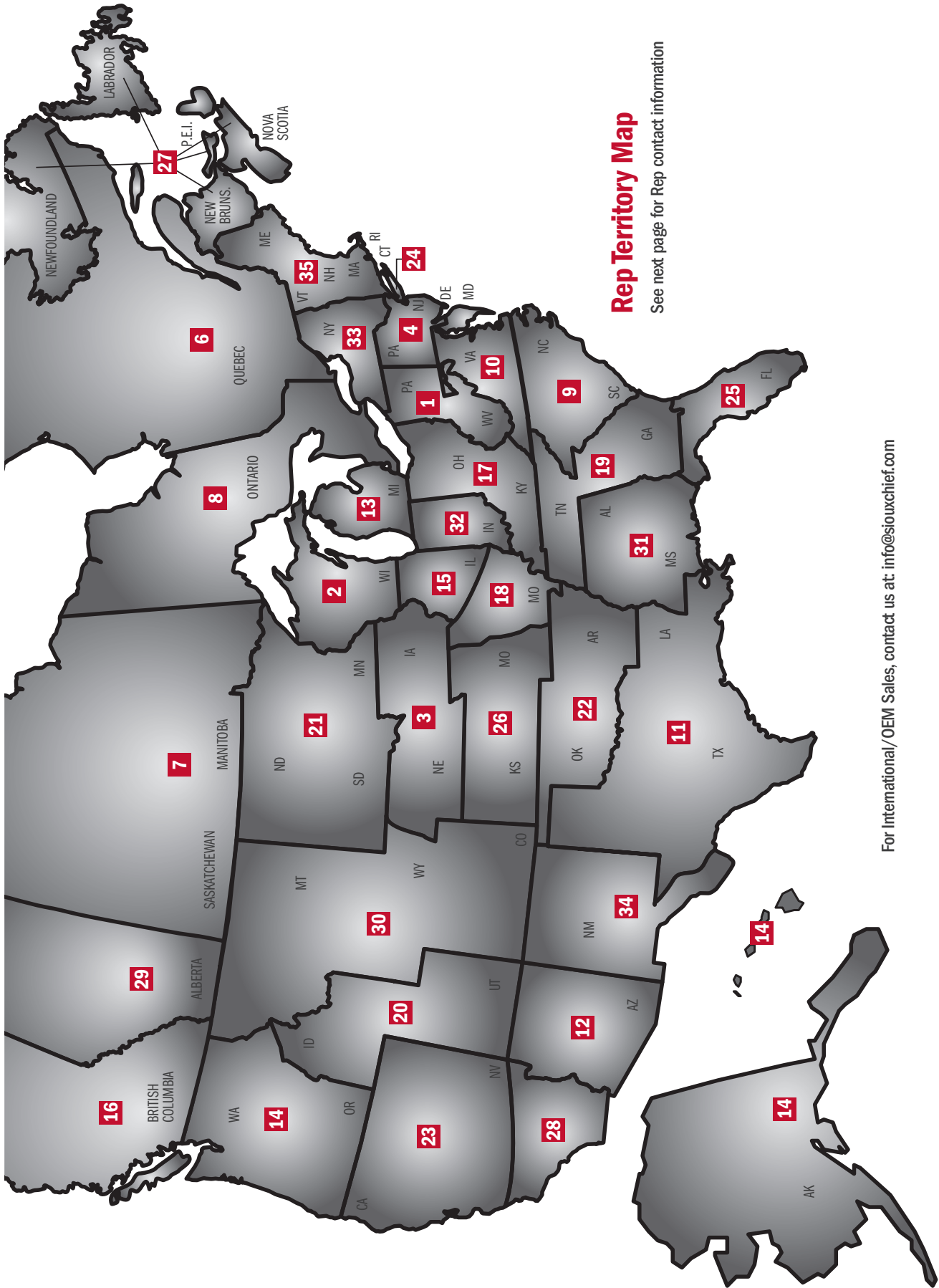

**Rep Territory Map**

See next page for Rep contact information

For International/OEM Sales, contact us at: [info@siouxchief.com](mailto:info@siouxchief.com)

Company	Territory	Phone	Website
1 B Daerr Sales	Western PA, WV	(412) 461-2476	bdaerrsales.com
2 Badgerland Trading Company	WI	(262) 827-3177	badgerlandtrading.com
3 Bulls-I Sales	IA, NE	(913) 649-8391	bullsisales.com
4 Burns Cope Associates	Northern DE, NJ, Eastern PA	(610) 485-2828	burnscope.com
5 C R G International Corp	Puerto Rico	(787) 796-2999	josereliablesales@gmail.com
6 Can-Aqua International	Quebec	(450) 625-3088	can-aqua.ca
7 Can-Aqua International	Saskatchewan Manitoba	(306) 501-4295 (204) 292-9749	can-aqua.ca
8 Cardinal Sales	Ontario	(905) 569-1419	cardinalsales.ca
9 Carolina Sales Associates	NC, SC	(803) 831-7227	csareps.com
10 Cathell & Associates	Southern DE, DC, MD, VA, WV	(571) 313-1390	cathell.com
11 Champions Marketing	TX, LA	(972) 602-0200	championsmarketing.com
12 Double A Sales Southwest	Arizona	(602) 359-9907	doubleasales.com
13 Exceptional Product Sales	MI	(586) 286-3240	eps.michigan@sbcglobal.net
14 Gordon & Associates	AK, WA, OR, HI	(360) 566-1470	gordonandassoc.com
15 Hart, Travers & Associates	IL	(800) 535-8525	htareps.com
16 Hy-Line Sales	British Columbia	(778) 657-6431	hylinesales.com
17 Lowder Sales	OH, KY	(800) 221-5650	lsireps.com
18 M R & Associates	Eastern MO & Southern IL	(314) 962-8960	mrrassocinc.com
19 McKee-Nix & Associates	GA, TN	(770) 934-8061	mckeenix.com
20 Mountain West Marketing	UT, ID	(801) 782-0100	mtnwm.com
21 Northland Reps	ND, SD, MN	(952) 854-3905	northlandreps.com
22 NSC Marketing	OK, AR	(405) 602-2800	nscok.com
23 Paramount Sales	Northern CA, NV	(925) 373-0817	paramountsales.biz
24 (house account)	New York Metro Area	(800) 821-3944	siouxchief.com
25 RSL Sales Associates	FL	(800) 538-4792	rlsales.com
26 SFE Enterprises	KS, MO	(816) 322-2206	sfeenterprises.com
27 Shoreline Mechanical Sales	Atlantic Canada	(902) 455-2939	shorelinemechanical.ca
28 Signature Sales	Southern CA, Las Vegas, NV	(951) 549-1000	signaturesalesinc.com
29 Spectrum Sales	Alberta	(403) 255-8332	spectrumsales.ca
30 T M Sales	MT, WY, CO, Western NE	(303) 375-1515	tmsalesinc.com
31 Tim Morales & Associates	AL, MS, FL panhandle	(251) 602-8333	timmorales.com
32 TOP Marketing	Indiana	(317) 575-9267	topmktg.com
33 Twin "D" Associates	NY	(800) 522-3523	twindassociates.com
34 W W Sales Company	NM, El Paso, TX	(505) 878-0636	wwsalesco.com
35 Walter F Morris Company	New England	(800) 888-1922	morrismerchants.com

# General Reference

Supply

- 1 cubic ft of water weighs 62.41 lbs.
- 1 cubic meter of water weighs 100 kg.
- 1 gallon (US) of water weighs 8.335 lbs.
- 1 liter of water weighs 1 kg.

Copper water tube and copper sweat fittings are referenced by their nominal (nom) size, which approximates the inside diameter (I.D.) waterway of the tube (1/2" nom, 3/4" nom, etc.).

Drainage

Compression fittings are referenced by the outside diameter (O.D.) of the tube they connect to (5/8" O.D., 7/8" O.D., etc.).

Copper water tube is manufactured in accordance with ASTM Standard B 88.

Support

Nominal Tube Size	Outside Diameter	Min. Wall Thickness	Weight Empty (lbs/ft)	Weight Full of Water (lbs/ft)
<b>SCHEDULE 40 STEEL</b>				
1/8"	0.405"	0.068"	0.2	0.4
1/4"	0.540"	0.088"	0.4	0.5
3/8"	0.675"	0.091"	0.6	0.7
1/2"	0.840"	0.109"	0.8	0.9
3/4"	1.050"	0.113"	1.1	1.3
1"	1.315"	0.133"	1.7	2.1
1 1/4"	1.660"	0.140"	2.3	2.9
1 1/2"	1.900"	0.145"	2.7	3.6
2"	2.375"	0.154"	3.6	5.0
2 1/2"	2.875"	0.203"	5.8	7.9
3"	3.500"	0.216"	7.6	10.8
3 1/2"	4.000"	0.226"	9.1	13.4
4"	4.500"	0.237"	10.8	16.3
<b>SCHEDULE 40 PVC</b>				
1/8"	0.405"	0.068"	0.04	0.06
1/4"	0.540"	0.088"	0.07	0.11
3/8"	0.675"	0.091"	0.10	0.18
1/2"	0.840"	0.109"	0.15	0.25
3/4"	1.050"	0.113"	0.20	0.40
1"	1.315"	0.133"	0.30	0.70
1 1/4"	1.660"	0.140"	0.40	1.00
1 1/2"	1.900"	0.145"	0.50	1.40
2"	2.375"	0.154"	0.60	2.00
2 1/2"	2.875"	0.230"	1.00	3.10
3"	3.500"	0.216"	1.30	4.50
3 1/2"	4.000"	0.226"	1.60	5.90
4"	4.500"	0.237"	1.90	7.40
<b>SCHEDULE 40 CPVC</b>				
1/4"	0.540"	0.088"	0.09	0.12
1/2"	0.840"	0.109"	0.19	0.28
3/4"	1.050"	0.113"	0.25	0.43
1"	1.315"	0.133"	0.38	0.76
1 1/4"	1.660"	0.140"	0.51	1.08
1 1/2"	1.900"	0.145"	0.61	1.49
2"	2.375"	0.154"	0.82	2.12
2 1/2"	2.875"	0.230"	1.29	3.29
3"	3.500"	0.216"	1.69	4.75
4"	4.500"	0.237"	2.33	7.68

Specialties

Appendix

Nominal Tube Size	Outside Diameter	Min. Wall Thickness	Weight Empty (lbs/ft)	Weight Full of Water (lbs/ft)
<b>SCHEDULE 80 STEEL</b>				
1/8"	0.405"	0.095"	0.3	0.4
1/4"	0.540"	0.119"	0.5	0.6
3/8"	0.675"	0.126"	0.7	0.8
1/2"	0.840"	0.147"	1.1	1.2
3/4"	1.050"	0.154"	1.5	1.7
1"	1.315"	0.179"	2.2	2.5
1 1/4"	1.660"	0.191"	3.0	3.5
1 1/2"	1.900"	0.200"	3.6	4.3
2"	2.375"	0.218"	5.0	6.3
2 1/2"	2.875"	0.276"	7.6	9.4
3"	3.500"	0.300"	10.2	13.0
3 1/2"	4.000"	0.318"	12.5	16.3
4"	4.500"	0.337"	15.0	20.0
<b>SCHEDULE 80 POLYPRO</b>				
1/2"	0.840"	0.147"	0.14	0.19
3/4"	1.050"	0.154"	0.19	0.33
1"	1.315"	0.179"	0.27	0.49
1 1/4"	1.660"	0.191"	0.38	0.85
1 1/2"	1.900"	0.200"	0.45	1.18
2"	2.375"	0.218"	0.62	1.61
<b>SCHEDULE 80 PVC</b>				
1/8"	0.405"	0.095"	0.05	0.06
1/4"	0.540"	0.119"	0.09	0.12
3/8"	0.675"	0.126"	0.10	0.16
1/2"	0.840"	0.147"	0.10	0.20
3/4"	1.050"	0.154"	0.20	0.40
1"	1.315"	0.179"	0.40	0.70
1 1/4"	1.660"	0.191"	0.50	1.00
1 1/2"	1.900"	0.200"	0.60	1.30
2"	2.375"	0.218"	0.90	2.20
2 1/2"	2.875"	0.276"	1.30	3.10
3"	3.500"	0.300"	1.80	4.60
3 1/2"	4.000"	0.318"	2.20	6.00
4"	4.500"	0.337"	2.60	7.60
<b>SCHEDULE 80 CPVC</b>				
1/4"	0.540"	0.119"	0.12	0.16
1/2"	0.840"	0.147"	0.24	0.31
3/4"	1.050"	0.154"	0.33	0.48
1"	1.315"	0.179"	0.49	0.85
1 1/4"	1.660"	0.191"	0.67	1.18
1 1/2"	1.900"	0.200"	0.81	1.61
2"	2.375"	0.218"	1.09	2.26
2 1/2"	2.875"	0.276"	1.65	3.49
3"	3.500"	0.300"	2.21	5.02
4"	4.500"	0.337"	3.23	8.08
<b>CTS CPVC (SDR 11)</b>				
1/2"	0.625"	0.060"	0.08	0.16
3/4"	0.875"	0.080"	0.14	0.31
1"	1.125"	0.102"	0.22	0.51
1 1/4"	1.375"	0.125"	0.33	0.76
1 1/2"	1.625"	0.148"	0.47	1.07
2"	2.125"	0.193"	0.80	1.83



Nominal Tube Size	Outside Diameter	Min. Wall Thickness	Weight Empty (lbs/ft)	Weight Full of Water (lbs/ft)
<b>COPPER TYPE K</b>				
3/8"	0.500"	0.049"	0.27	0.32
1/2"	0.625"	0.049"	0.34	0.43
5/8"	0.750"	0.049"	0.42	0.56
3/4"	0.875"	0.065"	0.64	0.83
1"	1.125"	0.065"	0.84	1.18
1 1/4"	1.375"	0.065"	1.04	1.57
1 1/2"	1.625"	0.072"	1.36	2.10
2"	2.125"	0.083"	2.06	3.37
2 1/2"	2.625"	0.095"	2.92	4.92
3"	3.125"	0.109"	4.00	6.96
3 1/2"	3.625"	0.120"	5.12	9.02
4"	4.125"	0.134"	6.51	11.57
<b>COPPER TYPE L</b>				
3/8"	0.500"	0.035"	0.20	0.26
1/2"	0.625"	0.040"	0.28	0.38
5/8"	0.750"	0.042"	0.36	0.51
3/4"	0.875"	0.045"	0.45	0.66
1"	1.125"	0.050"	0.65	1.01
1 1/4"	1.375"	0.055"	0.88	1.42
1 1/2"	1.625"	0.060"	1.14	1.91
2"	2.125"	0.070"	1.75	3.09
2 1/2"	2.625"	0.080"	2.48	4.54
3"	3.125"	0.090"	3.33	6.28
3 1/2"	3.625"	0.100"	4.29	8.28
4"	4.125"	0.110"	5.38	10.57
<b>COPPER TYPE M</b>				
1/2"	0.625"	0.028"	0.204	0.314
3/4"	0.875"	0.032"	0.328	0.551
1"	1.125"	0.035"	0.465	0.843
1 1/4"	1.375"	0.042"	0.682	1.25
1 1/2"	1.625"	0.049"	0.940	1.73
2"	2.125"	0.058"	1.460	2.83
2 1/2"	2.625"	0.065"	2.030	4.14
3"	3.125"	0.072"	2.680	5.70
3 1/2"	3.625"	0.083"	3.580	7.64
4"	4.125"	0.095"	4.660	9.83
<b>COPPER TYPE DWV</b>				
1 1/4"	1.375"	0.040"	0.65	1.22
1 1/2"	1.625"	0.042"	0.81	1.62
2"	2.125"	0.042"	1.07	2.48
3"	3.125"	0.045"	1.69	4.81
4"	4.125"	0.058"	2.87	7.88
<b>CAST IRON EXTRA HEAVY</b>				
2"	2.38"	0.190"	5.0	6.6
3"	3.50"	0.250"	9.0	12.7
4"	4.50"	0.250"	12.0	18.5
<b>CAST IRON SERVICE WEIGHT</b>				
2"	2.25"	0.17"	4	5.5
3"	3.25"	0.17"	6	9.4
4"	4.25"	0.18"	8	14.2
<b>NO-HUB CAST IRON</b>				
1 1/2"	1.90"	0.16"	2.7	6.2
2"	2.35"	0.16"	3.6	8.6
3"	3.35"	0.16"	5.2	13.5
4"	4.38"	0.19"	7.4	20.2

**Pipe Support Requirements**

Data from 2021 International Plumbing Code, Table 308.5

Piping Material	Maximum Horizontal Spacing (ft)	Maximum Vertical Spacing (ft)
ABS pipe	4	10 <sup>B</sup>
Aluminum tubing	10	15
Brass pipe	10	10
Cast iron pipe	5 <sup>A</sup>	15
CPVC pipe or tubing, ≤ 1"	3	10 <sup>B</sup>
CPVC pipe or tubing, ≥ 1 1/4"	4	10 <sup>B</sup>
Copper or copper-alloy pipe	12	10
Copper or copper alloy tubing ≤ 1 1/4" diameter	6	10
Copper or copper alloy tubing ≥ 1 1/2" diameter	10	10
PEX pipe, ≤ 1"	2.67 (32")	10 <sup>B</sup>
PEX pipe, ≥ 1 1/4"	4	10 <sup>B</sup>
PEX-AL-PEX pipe	2.67 (32")	4
Lead pipe	Continuous	4
PE-AL-PE pipe	2.67 (32")	4
PE-RT pipe, ≤ 1"	2.67 (32")	10 <sup>B</sup>
PE-RT pipe, ≥ 1 1/4"	4	10 <sup>B</sup>
PP pipe or tubing, ≤ 1"	2.67 (32")	10 <sup>B</sup>
PP pipe or tubing, ≥ 1 1/4"	4	10 <sup>B</sup>
PVC pipe	4	10 <sup>B</sup>
Stainless steel drainage systems	10	10 <sup>B</sup>
Steel pipe	12	15

A: The maximum horizontal spacing of cast iron pipe hangers shall be increased to 10 ft where 10-ft lengths of pipe are installed  
 B: For sizes 2" and smaller, a guide shall be installed midway between required vertical supports. Such guides shall prevent pipe movement in a direction perpendicular to the axis of the pipe

**Labor Cost Chart**

Dollars earned when you save time using Sioux Chief products.

Rate	Time				
	2 min.	5 min.	10 min.	15 min.	20 min.
\$20.00/hr	\$0.66	\$1.67	\$3.33	\$5.00	\$6.67
\$25.00/hr	\$0.83	\$2.08	\$4.17	\$6.25	\$8.33
\$30.00/hr	\$1.00	\$2.50	\$5.00	\$7.50	\$10.00
\$35.00/hr	\$1.17	\$2.92	\$5.83	\$8.75	\$11.67
\$40.00/hr	\$1.33	\$3.33	\$6.67	\$10.00	\$13.33
\$45.00/hr	\$1.50	\$3.75	\$7.50	\$11.25	\$15.00
\$50.00/hr	\$1.67	\$4.17	\$8.33	\$12.50	\$16.67
\$55.00/hr	\$1.83	\$4.58	\$9.17	\$13.75	\$18.33
\$60.00/hr	\$2.00	\$5.00	\$10.00	\$15.00	\$20.00
\$65.00/hr	\$2.17	\$5.42	\$10.83	\$16.25	\$21.67
\$70.00/hr	\$2.33	\$5.83	\$11.67	\$17.50	\$23.33
\$75.00/hr	\$2.50	\$6.25	\$12.50	\$18.75	\$25.00

# Sioux Chief Manufacturing

## ▶▶ Limited Lifetime Warranty

Supply

Drainage

Support

Specialties

Appendix

### Warranty

Sioux Chief Mfg. Co., Inc. ("Seller" or "the Seller") warrants its products to be free from defects in material and workmanship under normal usage for the lifetime of the plumbing system in which they were originally incorporated. In the event of such defects within the warranty period, the Company will, at its option, replace or recondition the product without charge. This remedy shall be effective only if the product was installed in accordance with supplied instructions, common installation or use practices and existing building and plumbing codes and legal requirements; has not been subjected to misuse or abuse; was at all times used in a manner consistent with its intended use; was at all times used in installations and environments acceptable to its material and design specifications; or any express conditions or requirements laid out in company installation instructions, manuals, tech bulletins, special labeling, precautions, as well as other instructional documents and product limitations of use; was never modified, altered or repaired by anyone other than the Seller; was properly subjected to and passed common testing methods (including pressure testing for potable water and drainage systems) immediately after the product's installation and before the product is put into service, was not damaged by freezing temperatures or excessive heats outside normal working or any express working range of the product; was not subjected to or exposed to direct or indirect chemical exposures; was not subjected to corrosion from atmospheric or environmental degradation (including UV exposure, brackish water, acidic water (pH <6.5), alkaline water (pH >8), contaminated soils, etc.), and was protected from natural causes; was never subjected to improper protection during installation and was handled with all precautions expressly written within company limitation documents or known to the industry; was not subjected to water pressures and flow conditions outside the working limits of the product; was not subject to adverse or aggressive water conditions (during testing, through stagnation or within service life (where service-life is defined by this warranty)) and where any express water condition included within company documents is avoided; and all handling was performed in a manner consistent and known to the industry or taught through company documents, labels, websites, manuals, etc. In addition, Seller shall not be responsible for any incidental, special or consequential damages, including without limitation, lost profits or the cost of repairing or replacing other property which is damaged, other costs resulting from labor charges, delays, vandalism, negligence, fouling caused by foreign material, chemical or any other circumstances over which the Seller has no control. This warranty excludes all costs arising from routine maintenance, including the replacement of any parts required by such maintenance and the replacement of parts required by normal wear and tear. The Seller also reserves the right to modify, alter or improve its product, or parts thereof, at any time without incurring an obligation to notify or modify, alter, improve or replace any product, or parts thereof, previously sold. If, on any occasion, Seller waives any term or condition, this waiver is not to be construed as a continuing waiver. For the purposes of this warranty, the lifetime of the original plumbing system is defined as the lesser of 25 years or the time before the plumbing system was replaced or materially changed; all products with automatically or manually moving parts are excluded from the limited lifetime warranty and carry a 3-year limited warranty, subject to the remaining terms, conditions and limitations of the warranty. Some States do not allow or have other parameters governing limitations on how long an implied warranty lasts, and some States do not allow the exclusion or limitation of incidental or consequential damages. This Limited Warranty gives you specific legal rights, and you may have other rights that vary from State to State. You should consult applicable state laws to determine your rights. THE WARRANTY SET FORTH HEREIN ABOVE AND BELOW IS GIVEN EXPRESSLY AND IS THE ONLY WARRANTY GIVEN BY THE COMPANY WITH RESPECT TO THE PRODUCT. THE COMPANY MAKES NO OTHER WARRANTIES, EXPRESS OR IMPLIED. THE COMPANY HEREBY SPECIFICALLY DISCLAIMS ALL OTHER WARRANTIES, EXPRESS OR IMPLIED, INCLUDING BUT NOT LIMITED TO THE IMPLIED WARRANTIES OF MERCHANTABILITY AND FITNESS FOR A PARTICULAR PURPOSE.

### Terms & Conditions

All sales are subject to the Standard Terms and Conditions set forth on Sioux Chief's website at [www.siouxchief.com](http://www.siouxchief.com). These terms include the following:

#### Return Merchandise

No merchandise can be returned without Seller's prior written authorization. All returns must comply with the guidelines established below.

#### Return Merchandise & Warranty Service

In order to return product/merchandise or receive warranty service, Buyer must first obtain a Return Merchandise Authorization ("RMA") by contacting Seller using the following information:

**MAIL:** Customer Service Manager  
Sioux Chief Manufacturing Company, Inc.  
14940 Thunderbird Road  
Kansas City, Missouri 64147  
**PHONE:** 816-425-9900 / 1-800-821-3944  
**FAX:** 816-348-7502 / 1-800-758-5950  
**EMAIL:** [info@siouxchief.com](mailto:info@siouxchief.com)

#### Return Merchandise Procedure

All merchandise returns and warranty claims are subject to the following general terms and conditions:

RMA requests must reference Seller's order number, invoice number or the customer's P.O. number.

Minimum return amount must be \$250 net value per purchase order.

Product returns can only be made within twelve (12) months of the original invoice date of the product to Buyer.

Seller reserves the right, at its sole and absolute discretion, to reject an RMA request for any reason at any time.

In order to be received and accepted by Seller, all returned product must be in whole multiples of the Minimum Quantity listed in the current Price Index and material must be in its original packaging with manufacturer's seal intact.

Products which are being phased-out, are obsolete, or were special-order (custom) are not considered normal stock. These items are non-returnable and non-refundable, except in the case of a manufacturer's defect.

Buyer will be charged 25% of the applicable return price for product restocking. For Drainage items having one or more listed option, Buyer will be charged 33% of the applicable return price for product restocking, and will apply to canceled orders that have been entered but not shipped.

An RMA is invalid 90 days after its date of issue.

Seller will only supply product credit for a product return or warranty claim. Issuance of an RMA does not authorize the Buyer to deduct the value of the returned item; once product is received and accepted by Seller, Seller will issue a credit memo for the returned product when applicable.

All product returns are subject to inspection and acceptance by Seller at its discretion.

Seller reserves the right to deny, nullify or cancel an RMA at its discretion.

Product returned without a Return Merchandise Authorization number will be destroyed without credit.

Seller shall not be responsible for shipping errors and shortages reported 5 days after receipt of material.

Seller shall not be responsible for shipment shortages that are signed for as clear. Any shipment that appears to be damaged in shipping must be noted when signing for receipt of delivery.

#### Full Freight Allowance

Sioux Chief will pay freight on all orders to single destinations totaling at least \$3,500 Net to locations within the 48 contiguous states (United States of America), at least \$7,000 Net to locations within Hawaii, Alaska, and Puerto Rico, and at least \$3,500 CAD Net to locations within Canada. Sioux Chief will pay freight on HydroTec™ and HydroBlock™ trench drain orders of at least \$5,000 Net to locations with the 48 contiguous states.

### Warranty Procedure - Product & Property

All claims for property or other damage are subject to the following additional terms and procedure:

If there is a warranty claim on a part that involves property or other damage, Seller should be contacted by phone or in writing directly following the loss, and in no case later than 15 days of the date of alleged claim or failure and before any remediation or alteration of the loss site has been started; any notice beyond this time frame or after work has taken place to repair or change the loss site will materially affect the Seller's ability to adjudicate the claim and will void the warranty.

The product in claim and/or its installation should not be modified before review by Seller; alteration of the alleged product or installation materially affects the Seller's ability to establish fault and voids the warranty.

Request a claim form. Submit the completed form to the Seller. Claimant will receive an INC (incident) number from Seller.

With the INC number, claimant should submit the claim form, including the date of the installation, description of problem, damage, pictures of the product, and repair invoices. This information should be sent to the above address at claimant's expense. Seller will not receive or process a claim without an INC number.

Seller will contact claimant with next steps, which may include a visit from a site investigator or other representatives of Seller, as Seller reserves the right to investigate all alleged loss sites.

### Processing of Orders

All orders are processed immediately upon receipt and acceptance by Seller. Seller reserves the right to charge back to Buyer costs incurred from order cancellations or changes, and to consider additions as separate orders.

Unless provided in writing by Seller, any dates and/or times quoted by Seller for the delivery of any goods or the performance of any services are estimates and Seller will not be held responsible for any delay. Buyer's receipt of goods or acceptance of services shall constitute a waiver of any claim for delay.

If Buyer requires expedited shipment of "in stock" goods prior to stated lead times on said order, Buyer will be charged \$100.00 (USD) for any 'expedited' shipping on items up to \$1,000.00 (USD) net, and \$100.00 (USD) + 2% of net for any 'expedited' shipping on items over \$1,000.00 (USD) net.

### Price Changes

All prices quoted from time to time by Seller are subject to change without notice up to time of shipment. Invoice totals and discounts will be calculated out to the sixth decimal digit.

If Buyer fails to give written notice of objection to Sioux Chief's order confirmation within ten (10) days after Buyer's receipt of Sioux Chief's confirmation of the purchase order, the order confirmation pricing becomes binding.

### Minimum Order Quantities

A 10% surcharge will be applied to any item not purchased in multiples of the stated Minimum Quantity, except on drop-ship orders.

Items with bold Minimum Quantities in the Numerical Index (back of catalog) can never be broken.

PEX tube bundles (sticks) may only be included on orders of \$40,000 Net or more. In addition, PEX tube bundles (sticks) must also be ordered in a minimum quantity of ten (10) or a \$100 surcharge will apply to the line item. Coils may be ordered in any quantity, and on orders of any amount.

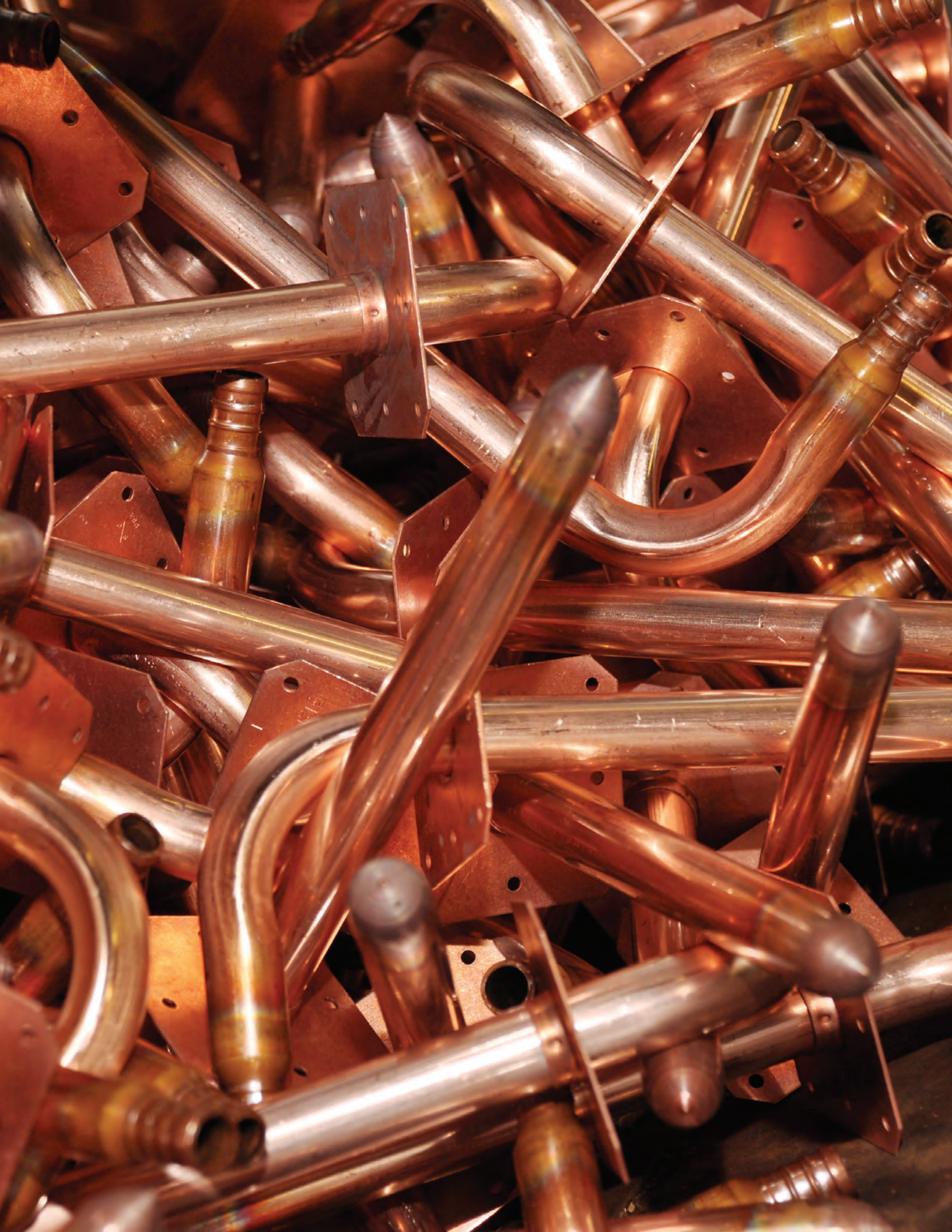

# TAKE THE FIELD.

**Sioux Chief Manufacturing Company, Inc.**

14940 Thunderbird Road

Kansas City, Missouri 64147

P 1-800-821-3944 | 816-425-9900

F 1-800-758-5950 | 816-348-7502

[www.siouxchief.com](http://www.siouxchief.com)

© 2022 Sioux Chief Manufacturing Company Inc.

**Online Pricing Guide**

Check up-to-date list prices anytime



<https://products.siouxchief.com>