

ITEM	PART NO.	DESCRIPTION	QTY.
1	DG0641D	GRATE: DUCTILE IRON SLOTTED 2FT	16
2	DA0542B	LOCKING DEVICE	16
3	DP0500C	END CAP – SOLID	2
4	DA0633	INSTALLATION CHAIR	9
5	DA0620A	CHANNEL EDGE PROTECTOR GALV – 48.00"	8PR
6	DP0500	CHANNEL NEUTRAL POLYCAST 500 – 48.00"	8
7	LIT-PC8	INSTALLATION MANUAL	1

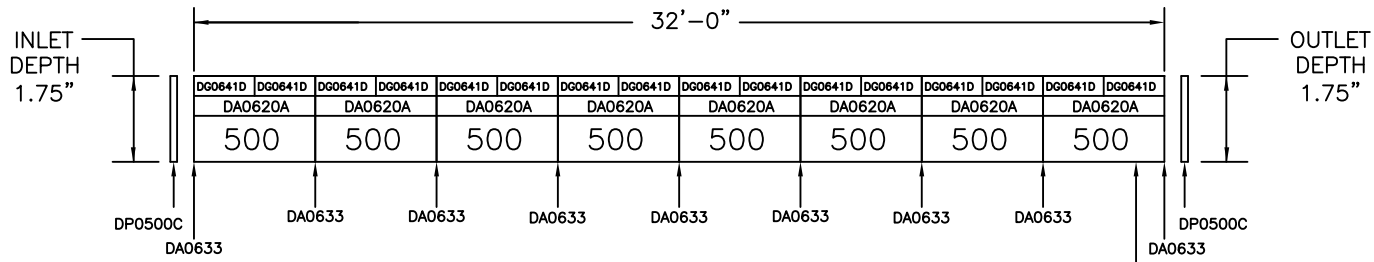

BOTTOM OUTLET
(BY CUSTOMER)

DRILL SIZE 3.50" FOR 3.0" SCH 40 & 80 PVC
 DRILL SIZE 4.25" FOR 4.0" SCR-35 SEWER & DRAIN
 DRILL SIZE 4.50" FOR 4.0" SCH 40 & 80 PVC

CUSTOMER APPROVAL

DATE: _____

NAME: _____

SIGNATURE: _____

I HAVE REVIEWED THE SYSTEM DIMENSIONS PROVIDED AND APPROVE TDS TO PROCEED WITH RELEASING FOR PRODUCTION. I UNDERSTAND THAT ONCE RELEASED FOR PRODUCTION, ANY REVISION WILL RESULT IN ADDITIONAL CHARGES.

CUSTOM ITEMS ARE NON-RETURNABLE

DISCLAIMER – THE CUSTOMER AND THE CUSTOMER'S ARCHITECTS, ENGINEERS, CONSULTANTS, AND OTHER PROFESSIONALS ARE COMPLETELY RESPONSIBLE FOR THE SELECTION INSTALLATION AND MAINTENANCE OF ANY PRODUCT PURCHASED FROM TRENCH DRAIN SYSTEMS AND/OR ITS MANUFACTURERS. TRENCH DRAIN SYSTEMS MAKES NO WARRANTY, EXPRESS OR IMPLIED, AS TO THE SUITABILITY, DESIGN, MERCHANTABILITY, OR FITNESS OF THE PRODUCT FOR CUSTOMERS APPLICATION. THE DRAWING AND INFORMATION PROVIDED REMAIN THE PROPERTY AND COPYRIGHT OF THE MANUFACTURER LISTED. THE MANUFACTURER RESERVES THE RIGHT TO MODIFY SPECIFICATION WITHOUT NOTICE.

REV	DESCRIPTION	BY	DATE

 TRENCH DRAIN SYSTEMS PO BOX 377 FREMONT, OH 43420 610-638-1221	DRAWN: CJP CHECKED: _____ DATE: 6.13.19
	DESCRIPTION POLYCAST 500 SYSTEM LENGTH; 32FT GV EDGING – DG0641D GRATE
	DWG. NO. PCK5-DG0641D-GE-32
	DO NOT SCALE DRAWING WEIGHT: 537# SHEET 1 OF 1

PROPRIETARY AND CONFIDENTIAL; THE INFORMATION CONTAINED IN THIS DRAWING IS THE SOLE PROPERTY OF TDS. ANY REPRODUCTION IN PART OR WHOLE WITHOUT THE WRITTEN PERMISSION OF TDS IS PROHIBITED.

STANDARD CHAIR INSTALLATION

(SECURE CHAIR IN BOTTOM DIMPLES ON THE CHANNELS)

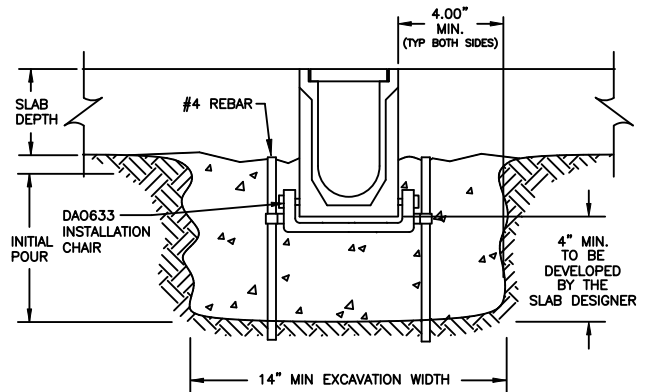

CHANNEL OUTLET DETAILS

(ALL END CAPS ARE TO BE SECURED WITH AN ADHESIVE)

