

# U100K

LOAD CLASS **UP TO C250** EN-1433 STANDARD



ULMA Linear Drainage Channel type U100K: External width 130mm; Internal width 100mm; Available with overall heights between 130mm and 250mm for 0,5% presloped channels and between 150 and 300 mm for cascaded slope, to collect rainwater in 1 metre long units; Integrated galvanized steel\* edges for lateral protection. Locking system consists of CS100 locking bar and screws.

\*Also available with stainless steel edge protection.

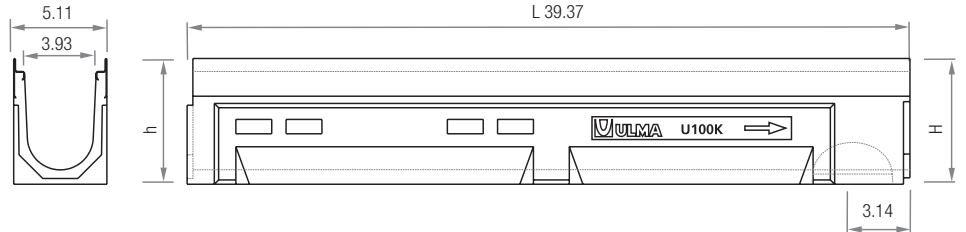

## Locking system

LOCKING BAR. Two locking bars and two screws per linear metre.



## Step Units

Code: CEU100



## Galvanized Steel Bucket

Code: CU100



## End Caps

Closed

Open

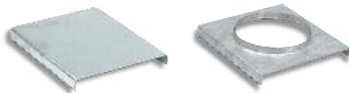

Channel	Code	Type	Ø (inches)
U100K00R	T100K00C	CLOSED	-
	T100K00A	OPEN	4.33
U100K05R	T100K05C	CLOSED	-
	T100K05A	OPEN	4.33
U100K10R	T100K10C	CLOSED	-
	T100K10A	OPEN	4.33
U100K15R	T100K15C	CLOSED	-
	T100K15A	OPEN	4.33
U100K20R	T100K20C	CLOSED	-
	T100K20A	OPEN	4.33
U100K25R	T100K25C	CLOSED	-
	T100K25A	OPEN	4.33
U100K30R	T100K30C	CLOSED	-
	T100K30A	OPEN	4.33

Channel	L (inches)	Height (inches)		Ø Outlet* (inches)		Hydraul. Section (cm <sup>2</sup> )	Pcs. / Pallet
		h	H	Vert.	Horiz.		
U100K00R	39.37	5.91	5.91	4.33	-	97	90
U100K01	39.37	5.91	6.10	-	-	97	90
U100K02	39.37	6.10	6.30	-	-	101	90
U100K03	39.37	6.30	6.50	-	-	106	78
U100K04	39.37	6.50	6.69	-	-	111	78
U100K05	39.37	6.69	6.89	-	-	116	78
U100K05R	39.37	6.89	6.89	4.33	-	120	78
U100K06	39.37	6.89	7.09	-	-	120	65
U100K07	39.37	7.09	7.28	-	-	125	65
U100K08	39.37	7.28	7.48	-	-	130	65
U100K09	39.37	7.48	7.68	-	-	135	65
U100K10	39.37	7.68	7.87	-	-	140	65
U100K10R	39.37	7.87	7.87	4.33	4.33	145	65
U100K11	39.37	7.87	8.07	-	-	145	65
U100K12	39.37	8.07	8.27	-	-	150	65
U100K13	39.37	8.27	8.46	-	-	155	65
U100K14	39.37	8.46	8.66	-	-	159	65
U100K15	39.37	8.66	8.86	-	-	164	65
U100K15R	39.37	8.86	8.86	4.33	4.33	169	65
U100K16	39.37	8.86	9.06	-	-	169	65
U100K17	39.37	9.06	9.25	-	-	174	65
U100K18	39.37	9.25	9.45	-	-	178	52
U100K19	39.37	9.45	9.65	-	-	183	52
U100K20	39.37	9.65	9.84	-	-	188	52
U100K20R	39.37	9.84	9.84	4.33	4.33	193	52
U100K25R	39.37	10.83	10.83	4.33	4.33	240	52
U100K30R	39.37	11.81	11.81	4.33	4.33	288	52

\*Vert. and horiz. outlets on order.

## Polymer Concrete Property Tests

Resistance to Compression  
STANDARD UNE 22 194



Bend resistance in tile  
STANDARD UNE 127 006

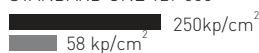

Shock Resistant (height)  
STANDARD UNE 127 007



Water absorption by capillarity  
(Weight Increase) RILEM C.P.C. 11.2

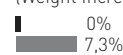

Water absorption  
STANDARD UNE 22 191



Abrasive Weathering  
STANDARD UNE 127 005/1

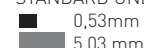

Resistance to chemical products

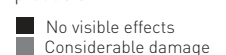

Resistance to freeze  
STANDARD UNE 127 004

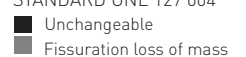

Legend for material types: Polymer concrete (black square), Traditional concrete (grey square).

# U100K



AK100

## Description:

ULMA Polymer concrete linear drainage sump unit model AK100.

Protective galvanized steel edge with a real thickness of 1+1mm, smooth, without breakage of the protective zinc layer, avoiding water accumulation and preventing corrosion.

2 point locking bar system.

Load class up to C250, EN 1433 Standard.

Vertically and horizontally aligning tange and groove joints.

CE Conformity Declaration and compliance with EN 1433 Standard.

Total height 22.05 inches, internal width 3.93 inches, total width 5.11 inches, and total length 19.69 inches.

Ø4.33 inches and Ø6.3 inches pre-formed knockouts.

## Sump units and accessories table

Code	L (inches)	H (inches)	Width (inches)	Ø Outlet (inches)		Sump Units	Bucket
				Lateral	Front		
AK100	19.69	22.05	5.11	4.33/6.30	3.54	1	CU100

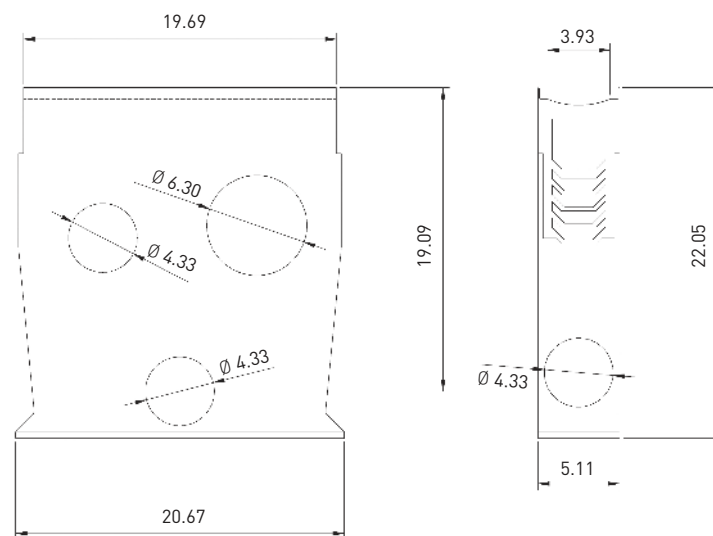

© June, 2016 ULMA Architectural Solutions. This information is believed to be accurate but it is not guaranteed to be so. We cannot assume liability for results that buyer obtains with our product since conditions of use are beyond the control of the company. It is the customer's responsibility to evaluate suitability and safety of product for his own use. ULMA Architectural Solutions reserves the right to change the product and specifications without notice.