

Z884 Perma-Trench 4-3/4" Shallow Drain System

2

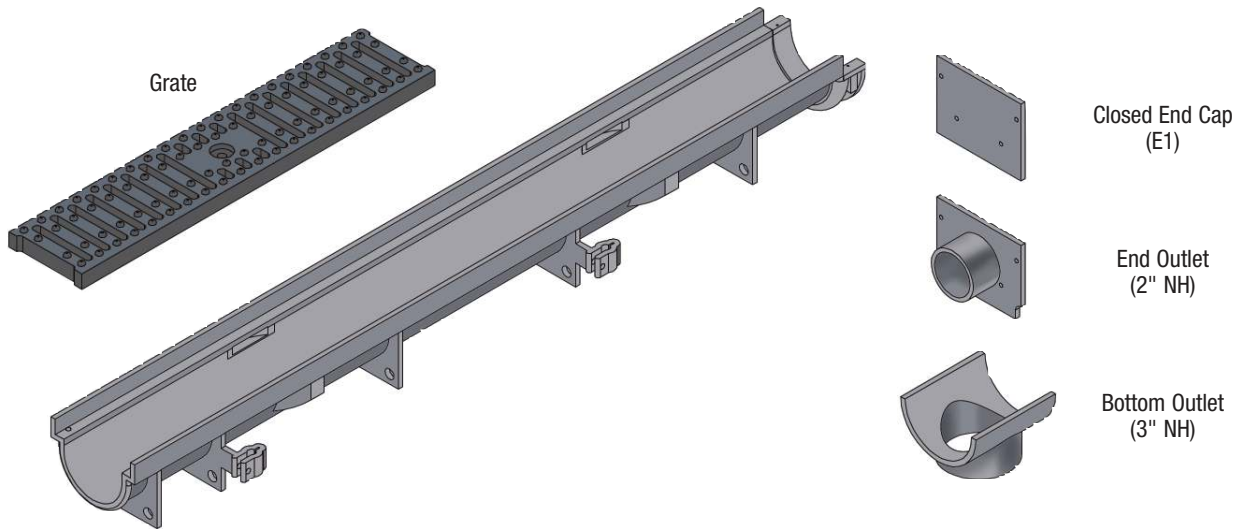

Z884 Applications

- Sidewalks
- Parking Garages
- Gas Stations
- Kitchens
- Pools
- Residential

Features and Benefits

- 40" Modular Channel Sections with 20" Grates
- Smooth Seamless Construction – Clean, sanitary installation.
- Durable and Lightweight – Strong corrosion-resistant material.
- 2-7/8" Trench Depth – For depth restricted applications.
- Variety of Gratings – Able to meet specific job requirements.
- Grate Options – Available in ADA.
 - CG Cast Iron Grate
 - FG Fabricated Galvanized Steel Slotted Grate
 - FS Fabricated Stainless Steel Slotted Grate
 - HPP Heel-proof Polyethylene Grate
 - PG Perforated Galvanized Steel Grate
 - PS Perforated Stainless Steel Grate

Installation Specification

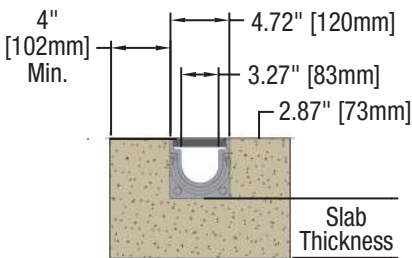

3-1/4" Throat / 4-3/4" Overall Width

Engineering Specification Channels shall be 40" long, 4-3/4" wide, and have a 3-1/4" wide throat. Modular channel sections shall be made of High Density Polyethylene (HDPE), have interlocking ends, and radiused bottom. Channel shall be provided flat (neutral) with a 2.875" invert. Channels shall have clips molded into the sides of the channel to accommodate vertical rebar for positioning and anchoring purposes. Choice of class A, B, and C grates shall be available with H-20 and/or ADA compliance with mechanical lockdown devices. End caps and catch basins shall be available to complement the channels and grates. End outlets in 2" diameter and bottom outlets in 3" diameter shall be available. Trench drain shall be Flo-Thru model Z884.

Z884 Dimensional Data

Number	Overall Depth		Approx. Wt. (Less Grate)	
	Inches	mm	Lbs.	Kg
884	2.875	73	2.3	1.04



Z884
4 1/8" WIDE GRATES

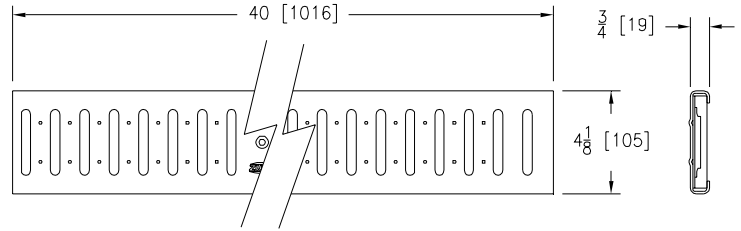
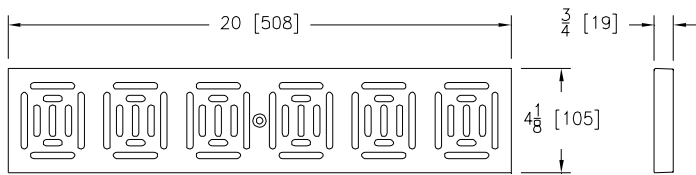

Please Check	Item No.
✓	1

BZ- Bronze Decorative		
Material : Bronze		
DIN Rating : Class A		
Weight: 4.05 # per ft.		
Open Area: 11.62 sq. in. per ft.		
ANSI Rating: Light Duty		
Application: Decorative Heelproof		
Slot Width/Hole Size: 0.25"		
ADA	H-20	FAA
Yes	No	No

Please Check	Item No.
✓	2

FG- Fabricated Galvanized Steel Slotted		
Material : Galvanized Steel		
DIN Rating : Class A		
Weight: 2.79 # per ft.		
Open Area: 7.8 sq. in. per ft.		
ANSI Rating: Light Duty		
Application: Lt. Vehicle Traffic		
Slot Width/Hole Size: 0.375"		
ADA	H-20	FAA
No	No	No

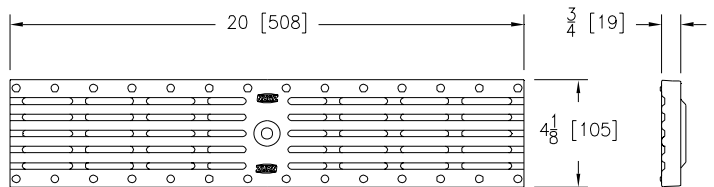
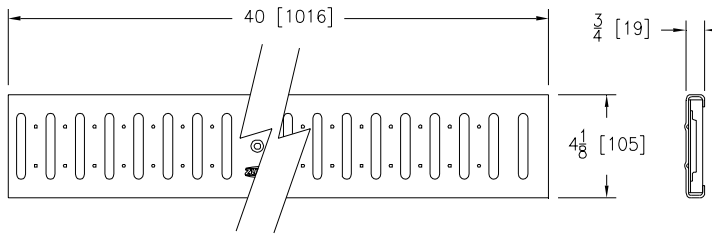

Please Check	Item No.
✓	3

FS- Fabricated Stainless Steel Slotted		
Material : Stainless Steel		
DIN Rating : Class A		
Weight: 2.88 # per ft.		
Open Area: 7.8 sq. in. per ft.		
ANSI Rating: Light Duty		
Application: Lt. Vehicle Traffic, Food/Bev. Process		
Slot Width/Hole Size: 0.375"		
ADA	H-20	FAA
No	No	No

Please Check	Item No.
✓	4

HPP- Heelproof Slotted		
Material : HDPE		
DIN Rating : Class A		
Weight: .69 # per ft.		
Open Area: 10.78 sq. in. per ft.		
ANSI Rating: Light Duty		
Application: Pedestrian, Chem., Swimming Pool		
Slot Width/Hole Size: 0.25"		
ADA	H-20	FAA
Yes	No	No



Z884
4 1/8" WIDE GRATES

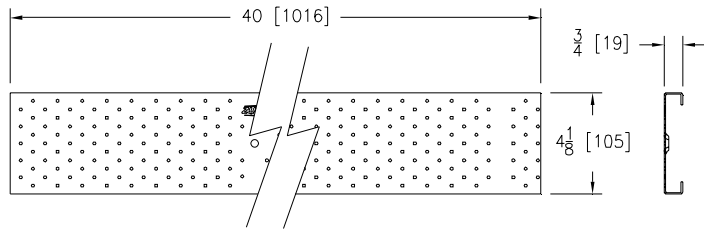

Please Check	Item No.
✓	5

PG- Perforated Galvanized Steel		
Material : Galvanized Steel		
DIN Rating : Class A		
Weight: 2.67 # per ft.		
Open Area: 15.25 sq. in. per ft.		
ANSI Rating: Light Duty		
Application: Heelproof, Pedestrian Traffic		
Slot Width/Hole Size: 0.125"		
ADA	H-20	FAA
Yes	No	No

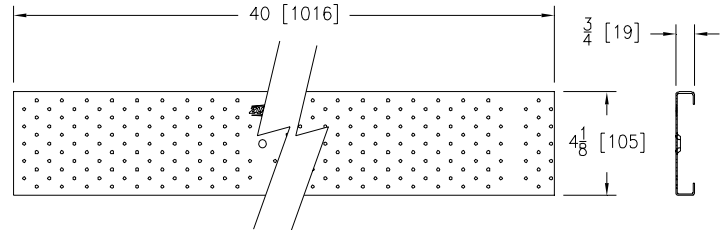

Please Check	Item No.
✓	6

PS- Perforated Stainless Steel		
Material : Stainless Steel		
DIN Rating : Class A		
Weight: 2.82 # per ft.		
Open Area: 15.25 sq. in. per ft.		
ANSI Rating: Light Duty		
Application: Heelproof, Food/Bev. Process		
Slot Width/Hole Size: 0.125"		
ADA	H-20	FAA
Yes	No	No

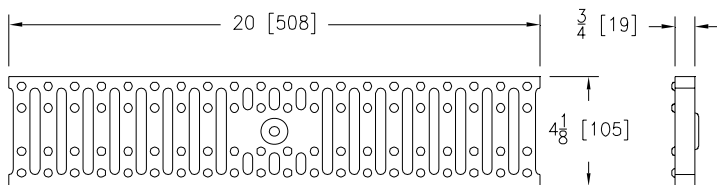

Please Check	Item No.
✓	7

CG- Cast Iron Slotted		
Material : Cast Iron		
DIN Rating : Class C		
Weight: 5.16 # per ft.		
Open Area: 12.5 sq. in. per ft.		
ANSI Rating: Medium Duty		
Application: Lt. Vehicle Traffic		
Slot Width/Hole Size: 0.375"		
ADA	H-20	FAA
No	No	No