

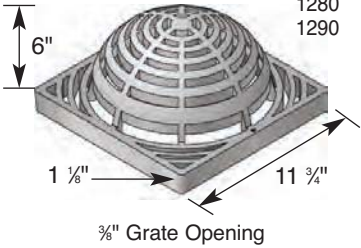

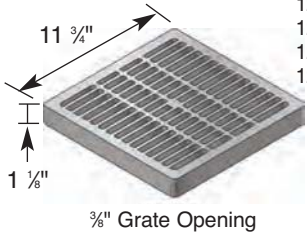



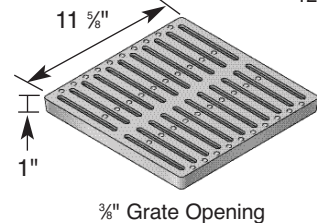

12" CATCH BASIN SERIES

	Part No.	Description	Color	Pkg. Qty.	Wt. Ea. (lbs.)	Product Class	Specifications
	1280	12" x 12" Atrium Grate	Green	8	2.00	10ND	NDS #1280, #1290, 12" Structural Foam Polyolefin Dome Atrium Grate with UV inhibitor. Open surface area 50.60 square inches. 66.29 GPM.
	1290	12" x 12" Atrium Grate	Black	8	2.0	10ND	
Use with 12" x 12" Catch Basin Series.							
	1210	12" x 12" Square Grate	Gray	8	2.00	10ND	NDS #1210, #1211, #1212, or #1212S, 12" Square Structural Foam Polyolefin Grate with UV inhibitor. Open surface area 50.76 square inches. 66.50 GPM.
	1211	12" x 12" Square Grate	Black	8	2.00	10ND	
	1212	12" x 12" Square Grate	Green	8	2.00	10ND	
	1212S	12" x 12" Square Grate	Sand	8	2.00	10ND	
	Use with 12" x 12" Catch Basin Series.						
 (See pg. 47) ADA Compliant							
	1213	12" x 12" Square Cast Iron Grate	Black	1	15.00	10ND	NDS #1213, 12" Square Heavy Duty Cast Iron Grate. Open surface area 59.50 square inches. 77.95 GPM.
	Use with 12" x 12" Catch Basin Series.						
 (See pg. 47) ADA Compliant							
	1215	12" x 12" Square Galvanized Steel Grate	Galvanized Steel	1	8.90	10ND	NDS #1215, 12" Square Heavy Duty Galvanized Steel Bar Grate. Open surface area 122.30 square inches. 160.21 GPM.
	Use with 12" x 12" Catch Basin Series.						
 (See pg. 47)							
	1214	12" x 12" Square Grate	Manganese Bronze	1	9.00	10ND	NDS #1214, 12" Square Manganese Bronze Grate and Frame. Open surface area 36.75 square inches. 48.14 GPM.
	Use with 12" x 12" Catch Basin Series. Screws in tabs on the frame, will secure the frame to the outside edge of 12" x 12" catch Basin Adapter. Note: (Frame must be attached to catch basin before backfilling or encasing in concrete.)						
 (See pg. 47) ADA Compliant/Heel-proof							
	1220	12" x 12" Sump Box Cover	Black	8	2.00	10ND	NDS #1220, 12" Square Structural Foam Polyolefin Solid Cover.
	Use with NDS 12" x 12" Catch Basin Series and NDS #1219 Backwater Valve Box.						

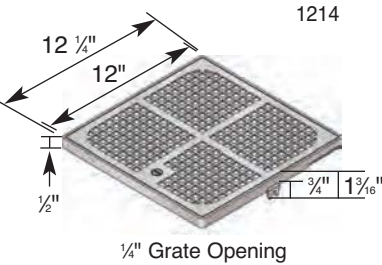

Note: All dimensions are nominal. All weights are for shipping purposes only. Availability is subject to change.

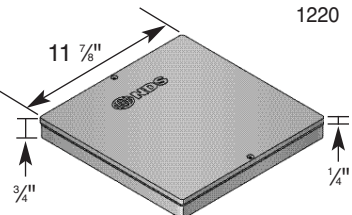
For customer service, please send your fax to: 1-800-726-1998 or call 1-800-726-1994.

1200NGB™ NEXT GENERATION CATCH BASIN

new

The 1200NGB™ Next Generation Catch Basin from NDS is a 12"x 12" catch basin that has unique inlet/outlets with three adjustable positions. The basin can accept pipe at various elevations and sizes using universal outlet adapters to accommodate the job's needs. The inlet/outlet Slides are connected after the inlet/outlet elevation is chosen. The NGB allows for greater flexibility during drainage installations, saving time and money.

1200NGB INSTALLATION INSTRUCTIONS

Step 1: Based on pipe position, choose inlet/outlet height of the NGB.

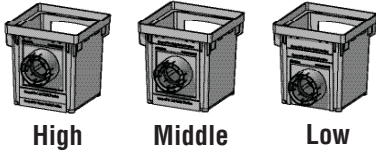

Step 2: Break off the tabs on the Slides to adjust the height of the inlet/outlet.

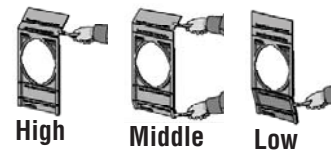

Step 3: Place Slide into the outside of the NGB from the bottom. Push Slide up gently until it snaps into place.

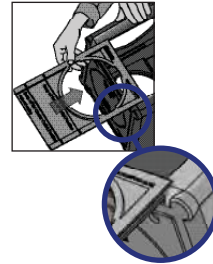

Step 4: Attach the Universal Outlet to the Slide and connect pipe to finish the installation.

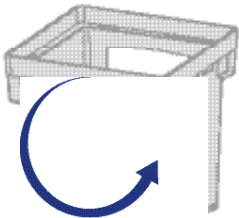
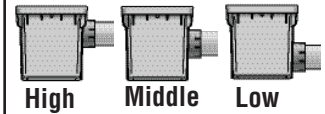

1245 Offset Universal Outlet: Further Flexibility

Maximize inlet/outlet adjustability in 3/4" increments by using the Offset Universal Outlet, part number 1245 (See page 25).

Part No.	Description	Color	Pkg. Qty.	Wt. Ea. (lbs.)	Product Class	Specifications
1200NGBDISPLAY	Distributor display with 8 1200NGBKITs	Black	8	47.20	10ND	NDS #1200NGB is made out of polyolefin, NDS #1207 and #1208 are made out of styrene
1200NGBKIT	12" x 12" Catch Basin, 2 Open Slides	Black	4	4.65	10ND	
1200NGB	12" x 12" Catch Basin	Black	4	3.45	10ND	
1207	Open Slide for 1200NGB	Black	8	.60	10ND	
1208	Plug Slide for 1200NGB	Black	8	.76	10ND	

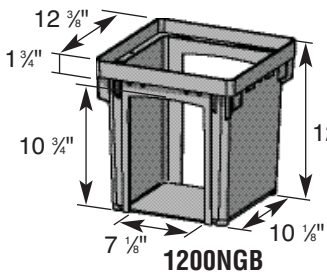

1200NGB

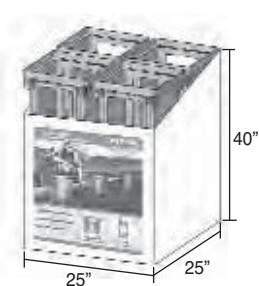

1200NGBDISPLAY

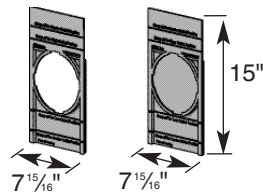

Open Slide requires either #1206, #1242, #1243, #1245, #1266 or #1889 Universal Outlet for each inlet/outlet. (See page 24)

Fits all 12" x 12" NDS Grates
Fits all NDS universal outlets

BOTTOM FEATURES TO ELIMINATE STANDING WATER

Bottom Cut out for Universal Outlet

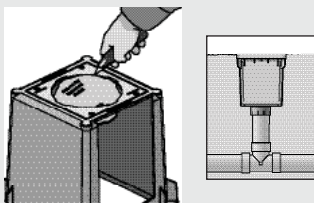

1/2" Drain Holes

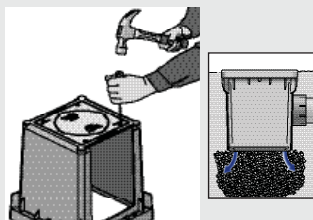

No bottom Option

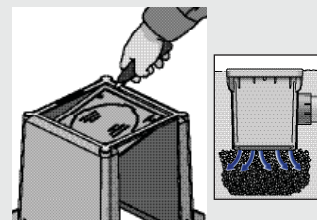

Note: All dimensions are nominal. All weights are for shipping purposes only. Availability is subject to change.

12" CATCH BASIN SERIES

Part No.	Description	Color	Pkg. Qty.	Wt. Ea. (lbs.)	Product Class	Specifications
1200	12" x 12" Catch Basin, 2 Openings	Black	4	4.25	10ND	NDS #1200, #1203, or
1203	12" x 12" Catch Basin, 3 Openings	Black	4	3.75	10ND	#1204, 12" x 12" Tapered
1204	12" x 12" Catch Basin, 4 Openings	Black	4	3.75	10ND	Catch Basin.

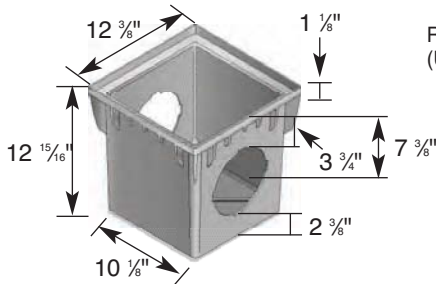

Requires either #1206, #1242, #1243, #1245, #1266 or #1889 Universal Outlet for each opening. (Use bottom cutout for additional outlet. See page 24.)

Part No.	Description	Color	Pkg. Qty.	Wt. Ea. (lbs.)	Product Class	Specifications
1216	12" x 12" Catch Basin Riser (No Bottom)	Black	8	2.75	10ND	NDS #1216, 6" Riser for 12" Catch Basin.

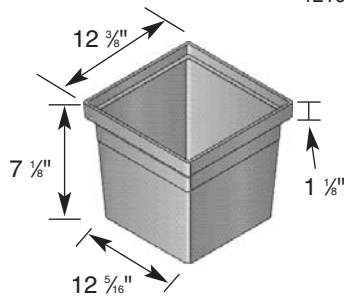

Use with 12"x12" Catch Basin Series.

Part No.	Description	Color	Pkg. Qty.	Wt. Ea. (lbs.)	Product Class	Specifications
1217	12" x 12" Riser with 2 openings	Black	4	4.0	10ND	NDS #1217, 12" Riser with Two Openings.

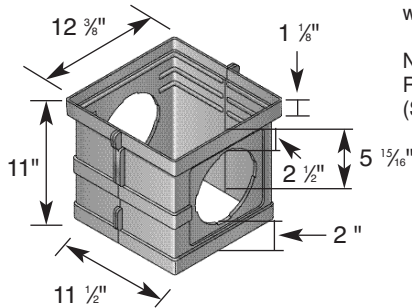

Nests on top of 12" catch basin series for shallow outlets and 12" sump box for more sump area. Requires either #1206, #1242, #1243, #1245, #1266 or #1889 Universal Outlet for each opening. (See page 24.)

Part No.	Description	Color	Pkg. Qty.	Wt. Ea. (lbs.)	Product Class	Specifications
1225	12" x 12" Sump Box	Black	4	6.75	10ND	NDS #1225, one piece 12" Sump Box.

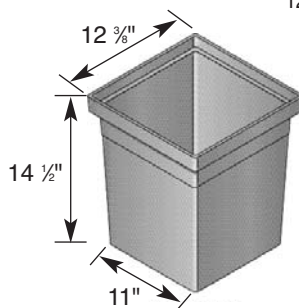

Use with 12" x 12" Grate or #1220 Valve Box Cover.



Note: All dimensions are nominal. All weights are for shipping purposes only. Availability is subject to change.

For customer service, please send your fax to: 1-800-726-1998 or call 1-800-726-1994.

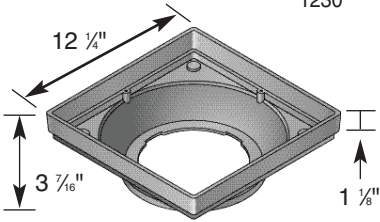

12" CATCH BASIN SERIES/18" CATCH BASIN SERIES

Part No.	Description	Color	Pkg. Qty.	Wt. Ea. (lbs.)	Product Class	Specifications
1230	12" x 12" Low Profile Adapter	Black	8	1.25	10ND	NDS #1230, 12" x 12" Low Profile Adapter with Bayonet Bottom Outlet.

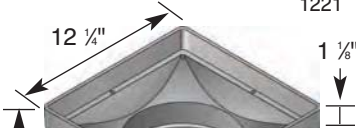

Requires either #1243, #1245, #1266 or #1889 Universal Outlet for connection to 3", 4", or 6" Sewer and Drain or Corrugated Pipe. (See page 24.)

Part No.	Description	Color	Pkg. Qty.	Wt. Ea. (lbs.)	Product Class	Specifications
1221	12" x 12" Square, Low Profile Adapter	Black	12	1.92	10ND	NDS #1221, or #1222, 12" x 12" Low Profile Adapter.
1222	12" x 12" Square, Low Profile Spigot Adapter	Black	12	1.92	10ND	Fits 8" Corrugated Pipe.

Fits 8" Sewer and Drain Pipe.

18" CATCH BASIN SERIES

Part No.	Description	Color	Pkg. Qty.	Wt. Ea. (lbs.)	Product Class	Specifications
1881	18" x 18" Atrium Grate	Black	2	3.50	10ND	NDS #1881, #1891, 18" Structural Foam Polyolefin Dome Atrium Grate with UV inhibitor. Open surface area 89.40 square inches. 117.11 GPM.
1891	18" x 18" Atrium Grate	Green	2	3.50	10ND	

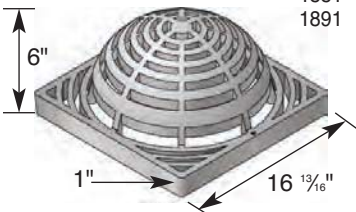

Use with 18" x 18" Catch Basin Series.

1/2" Grate Opening

Part No.	Description	Color	Pkg. Qty.	Wt. Ea. (lbs.)	Product Class	Specifications
1810	18" x 18" Square Grate	Gray	4	5.50	10ND	NDS #1810, #1811, #1812, 18" Square Structural Foam Polyolefin Grate with UV inhibitor. Open surface area 104.00 square inches. 136.24 GPM.
1811	18" x 18" Square Grate	Black	4	5.50	10ND	
1812	18" x 18" Square Grate	Green	4	5.50	10ND	

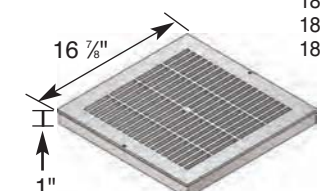

Use with 18" x 18" Catch Basin Series.



(See pg. 47)

ADA Compliant

7/16" Grate Opening

Part No.	Description	Color	Pkg. Qty.	Wt. Ea. (lbs.)	Product Class	Specifications
1813	18" x 18" Cast Iron Square Grate	Black	1	35.00	10ND	NDS #1813, 18" Square Heavy Duty Cast Iron Grate. Open surface area 100.63 square inches. 131.83 GPM. H-20 Load Rating.

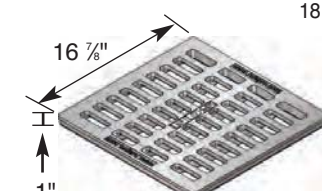

Use with 18" x 18" Catch Basin Series.



(See pg. 47)

1" Grate Opening

Note: All dimensions are nominal. All weights are for shipping purposes only. Availability is subject to change.